



TABELA DE PREÇOS

2025

Validade 28.02.2026





BETA SIGNIFICA  
AUDÁCIA. COMPROMISSO. HARMONIA. TALENTO.



Na Beta, só existe uma forma de fazer as coisas: fazê-las bem.

Este é o mundo Beta, este é o princípio que guia o nosso trabalho diário em todo o mundo, driven by four values:

 **AUDÁCIA** investir e desenvolver constantemente uma empresa criada por um artesão Italiano em 1923, que se afirmou mundialmente e continua a crescer após quatro gerações.

 **COMPROMISSO** em garantir a qualidade dos nossos produtos, porque cada revendedor sabe que pode contar com um atendimento eficiente, e cada utilizador sabe que pode contar com a precisão, fiabilidade e resistência dos produtos Beta.

 **HARMONIA** das linhas, para um design de excelência, porque quando algo é bem feito, expressa um equilíbrio perfeito entre a função e o design.

 **TALENTO** é o nosso recurso mais valioso, aquele que distingue todos os nossos colaboradores e que leva cada profissional a optar pela Beta para não deixar nada ao acaso, na realização cativante e apaixonada das suas ideias e sonhos.





# ÍNDICE

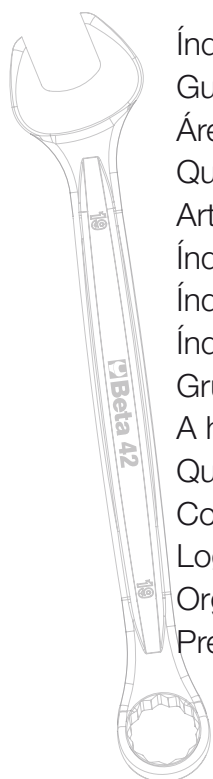

Índice .....	4
Guia de leitura .....	8
Áreas de aplicação de chaves e barras dinamométricas .....	58-59
Quadro de jogos e malas de ferramentas .....	343, 492-493
Artigos eliminados - artigos de substituição/recomendados .....	727÷732
Índice alfabético .....	733÷737
Índice para ferramentas de veículos automóveis .....	738÷740
Índice Alfanumérico .....	741÷755
Grupo beta - os números .....	756
A história das ferramentas italianas .....	757
Qualidade certificada .....	758
Controlo e qualidade .....	759
Logística .....	760
Organização do trabalho .....	761
Presença eficaz .....	762

## MOBILIÁRIO PARA OFICINA RSC55



RSC55

416÷440; 488÷491

## MOBILIÁRIO PARA OFICINA RSC50 2.0



Beta  
RSC50 2.0

441÷463; 488÷491

## MOBILIÁRIO PARA OFICINA C45PRO 2.0



Beta  
C45PRO 2.0

464÷487; 488÷491

## JOGOS DE FERRAMENTAS E MALAS



343÷361



362÷391



375; 392÷414

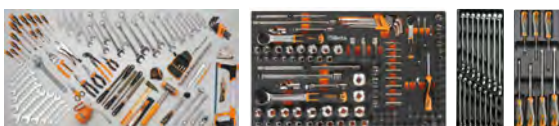

492÷569

## CHAVES DE APERTO



11÷17

23÷28

112÷117

## CHAVES DE CAIXA E ACESSÓRIOS



69÷78

85÷112

## CHAVES DINAMOMÉTRICAS E MULTIPLICADORES DE BINÁRIO



54÷56

57÷69

## CHAVES DE PARAFUSOS, CHAVES EXTREMIDADE MACHO E PONTAS



18÷23

78÷85

115÷117

143÷157

## ALICATES E ALICATES DE CORTE



126÷133

137÷140

231÷232



## MARTELOS E CINZÉIS



9÷10

164÷167

212

## FERRAMENTAS DE FURAR E ROSCAR



36÷41

41÷43

43÷51

51÷53

## EXTRACTORES



168÷169

194÷199; 203

## FERRAMENTAS DE MEDIR E TRAÇAR



205÷212

## FERRAMENTAS DE CORTE E MANUTENÇÃO GERAL



121÷122

132÷135

156÷157

178



204

213÷223



233÷237

## ILUMINAÇÃO



237÷242

## ENROLADORES



242÷244; 339

## FERRAMENTAS PARA CANALIZADORES



28÷35

## ELECTRÓNICA E MICROMECAÂNICA

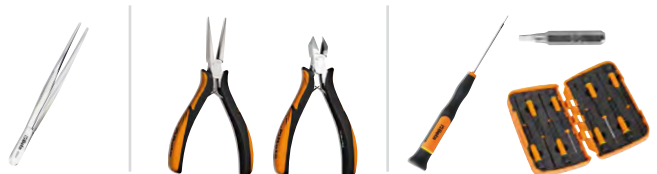

124÷125

140÷142

146÷149

## ELECTROTÉCNICA



135÷137

148

585÷587

227÷231

## FERRAMENTAS ISOLADAS 1000V



278÷284



## FERRAMENTAS EM AÇO INOX



292÷296

## FERRAMENTAS ANTI-FAÍSCA



297÷305

## REPARAÇÃO DE VEÍCULOS



118÷124

158÷163



168÷194; 199÷202

224÷233



247÷254

## EQUIPAMENTO PARA OFICINA



254÷266

## FERRAMENTAS PARA MOTOCICLOS



267÷272

## FERRAMENTAS PARA BICICLETAS



273÷277

## PRODUTOS ELÉTRICOS



306÷319

## FERRAMENTAS PNEUMÁTICAS E ACESSÓRIOS



320÷342

## FERRAMENTAS ANTI-QUEDA



285÷291

## BETA CHEMICALS



572÷578

## BETA ABRASIVES



579÷584

## PRODUTOS DA MARCA BM



588÷594

## ROBUR ACESSÓRIOS PARA CABOS

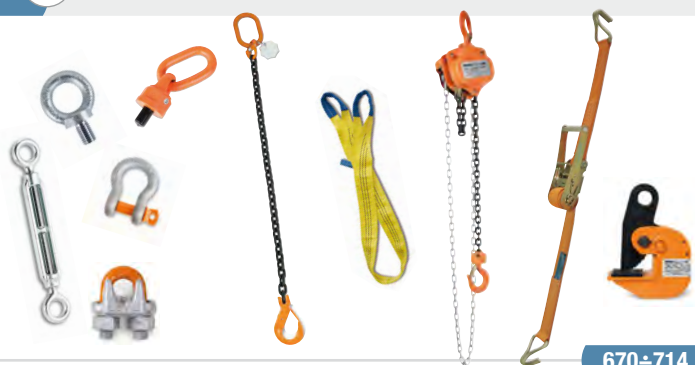

670÷714

## BETA COLLECTION

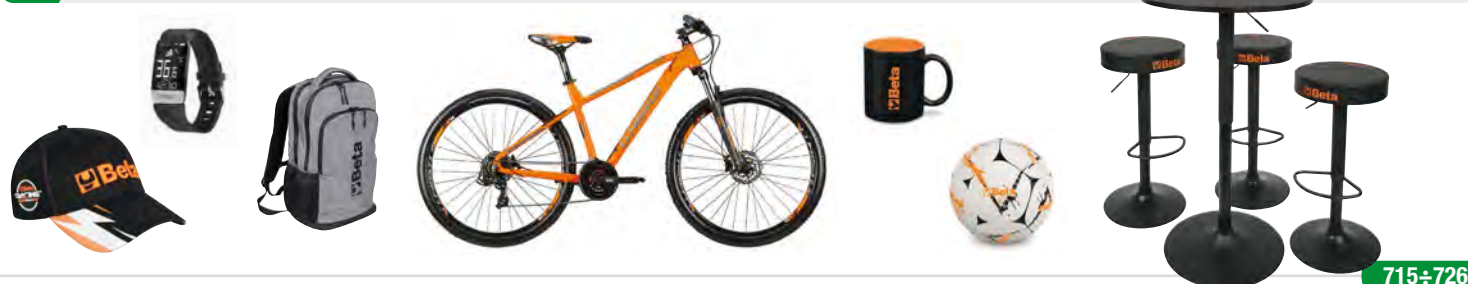

715÷726

## CALÇADO DE SEGURANÇA (E MEIAS TÉCNICAS)



624÷649

## VESTUÁRIO DE TRABALHO



650÷669

## GAMA BLISTER



595÷609

## EXPOSITORES PARA PONTOS DE VENDA



610÷623

## Referência

**42MP**

chaves mistas boca/luneta em cromado brilhante

## Perfil da ferramenta



## Preço unitário

★ artigo disponível a pedido

• tamanho principal

○ encabadouro sextavado

## Dimensão

## Quantidade por caixa

## Quantidade de peças por jogo

## Símbolo da embalagem

## Conteúdo da série

DIN 3113 UNI-ISO 7738

mm	mm	€	Código
6x6	100	13,80	5 000421606
7x7	110	13,90	5 000421607
8x8	120	14,00	5 000421608
9x9	130	14,10	5 000421609
10x10	140	14,20	5 000421610
11x11	150	14,30	5 000421611
12x12	158	14,40	5 000421612
13x13	170	14,50	5 000421613
14x14	178	14,60	5 000421614
15x15	190	14,80	5 000421615
16x16	199	15,00	5 000421616
17x17	209	15,30	5 000421617
18x18	219	15,60	5 000421618
19x19	230	16,00	5 000421619
20x20	240	16,40	3 000421620
21x21	250	16,80	3 000421621
22x22	260	17,30	3 000421622
24x24	280	18,30	3 000421624
27x27	307	19,10	3 000421627
30x30	337	20,40	3 000421630
32x32	360	21,10	3 000421632



42MP/B9  
6-7-8-10-11-13-14-17-19 mm  
2002/BV9

€ 153,00 1 000421661  
€ 12,70 1 020020030

em blister

Ferramentas para motociclos

Ferramentas para bicicletas



Código

Novidade 2025

## Significado dos símbolos mais usados

## Exemplo

Em jogos		Exemplo
B	= Em bolsa plástica	42/B9N
BV	= Bolsa plástica vazia	2002/BV9
C	= Em caixa metálica	900/C11
D	= Em caixa expositora	1293/D6
S	= Em caixa de cartão	42/S17
SP	= Em expositor	42/SP25
SPV	= Expositor vazio	42/SPV7
SC	= com suporte compacto	96/SC9
SCV	= suporte compacto, vazio	96/SCV

## Assortments

AS	= Com ferramentas em polegadas	5915VU/AS
E	= Para electrónica/electrotécnica	5980ET/A
I	= Para a hidráulica	5980ID
MT	= Para movimentação de terras	5902MT
U	= Para reparação universais	5915VU/3
SBK	= Para reparação de motociclos	5940SBK
VG	= Para reparação auto	5904VG/5T
VI	= Para manutenção industrial	5902VI

## Em chaves de caixa

A	= Perfil de 6 faces	910A
B	= Perfil de 12 faces	910B
ES	= Perfil dentado	920ES
FTX	= Parafusos TORX®	910FTX

## Significado dos símbolos mais usados

## Exemplo

PT	= Para parafusos com cabeça de 5 nervuras	910PT
X	= Roquete reversível em caixa metálica	920A/C12X

## Em chaves para parafusos e pontas para aparafusadoras

LP	= Para parafusos de fenda	920LP
PE	= Para parafusos hexagonais	920PE
PH	= Para parafusos PHILLIPS®	920PH
PZ	= Para parafusos POZIDRIV® - SUPADRIV®	1299PZ
RTX	= Para parafusos TAMPER RESISTANT TORX®	1298RTX
SP	= Para parafusos SPANNER	861SP
TRW	= Para parafusos TRI-WING®	861TRW
TQS	= Para parafusos TORQ-SET®	861TQS
TX	= Para parafusos TORX®	920TX
XZN	= Para parafusos XZN®	920XZN

## Na generalidade

AS	= Medidas em polegadas	42AS
BA	= Ferramenta anti-faísca	42BA
BM	= Punho com dois materiais	1150BM
C	= Caixa metálica vazia	C25
HS	= Ferramentas anti-queda	42HS
INOX	= ferramentas em aço inoxidável	42 INOX
L	= Modelo longo	952L
MQ	= Isolamento até 1000V	1150MQ
MP	= Cromado brilhante	42MP
R	= Peça de reposição	338R

Todas as informações e imagens que aparecem neste catálogo são meramente indicativas e sem qualquer valor contratual. A Beta Utensili reserva-se ao direito de alterar ou actualizar a sua gama de produtos sem aviso prévio, e sem obrigação de efectuar qualquer modificação sobre os modelos vendidos anteriormente.



**Beta** RECOMENDA a utilização da ferramenta adequada à tarefa a desempenhar, respeitando as normas de segurança individual.





# SACA-TROÇOS

As ferramentas de impacto Beta são concebidas para uma ótima performance e para garantir a segurança do operador.

É utilizado um tipo especial de aço cromado com molibdénio e vanádio (65CrMoV2-2) na produção, resultando e ferramentas de extraordinária dureza e robustez. Os produtos são fabricados com barras de tração – desde que a sua geometria o permita; caso contrário, são forjados a quente em atmosfera controlada, para evitar a formação de escória.

**1** Os perfis sextavados previnem que a ferramenta role na superfície de apoio.

**2** os saca-troços possuem veios muito longos, robustos e perfeitamente retos, para acesso a espaços confinados.

**3** Para assegurar que os saca-troços têm dimensões perfeitas, todas as peças têm um componente cilíndrico uniforme e uma extremidade perfeitamente plana, para maior eficiência.

**4** Todas as faces são temperadas por indução, para evitar a cisão; a deformação do ponto de embate é uma consequência natural que garante a segurança do operador.



Os saca-troços são afiados após serem cromados, para melhor desempenho de corte e gravação e para remoção do depósito galvânico das pontas. É necessário remover depósitos adicionais, de forma a impedir o "arredondamento" dos cantos e a fragilidade resultantes da quantidade de hidrogénio produzido durante a galvanização. As áreas trabalhadas possuem revestimento de proteção antiferrugem.



## 30

punções



Ø mm	L mm	€	Unidade	Artigo
2	125	8,30	10	000300020
3	125	8,30	10	000300030
4	150	11,10	10	000300040
5	150	11,10	10	000300050
6	150	11,60	10	000300060

## 31

saca-troços



Ø mm	L mm	L1 mm	€	Unidade	Artigo
2	110	22	8,30	10	000310002
3	128	35	8,60	10	000310003
4	146	45	10,50	10	000310004
5	164	55	11,10	10	000310005
6	182	65	13,90	5	000310006
8	200	80	14,70	5	000310008
10	220	95	18,40	5	000310010
12	250	115	19,70	3	000310012



Artigo	€	Unidade	Artigo
31/B6N	76,50	1	000310024
2002/BV6	10,00	1	020020000
31/SP6	90,50	1	000310030
31/SPV	26,00	1	000310031

## 31BM

saca-troços com punho



Ø mm	L mm	L1 mm	€	Unidade	Artigo
2	168	42	16,90	2	000310402
3	180	52	17,40	2	000310403
4	191	62	19,00	2	000310404
5	200	72	20,00	2	000310405
6	221	82	22,90	2	000310406
8	235	94	24,10	2	000310408



Artigo	€	Unidade	Artigo
31BM/D6	120,00	1	000310420

## 31L

saca-troços série longa



Ø mm	L mm	L1 mm	€	Unidade	Artigo
4	175	80	12,50	5	000310104
5	175	80	13,30	5	000310105
6	175	80	15,70	5	000310106

## 31SE

saca-troços para cavilhas elásticas

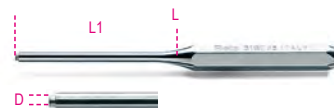

Ø mm	D mm	L mm	L1 mm	€	Unidade	Artigo
4	2,4	175	80	12,50	5	000310204
5	3,0	175	80	13,30	5	000310205
6	3,6	175	80	15,70	5	000310206



Artigo	€	Unidade	Artigo
31/B6N-LSE	93,00	1	000310324
31L: 4-5-6 mm			
31SE: 4-5-6 mm			
2002/BV6	10,00	1	020020000

## 32

punções de bico



Ø mm	L mm	L1 mm	€	Unidade	Artigo
3	100	44	7,70	10	000320100
4	125	52	9,50	10	000320125
5	150	62	11,60	10	000320150

## 32AU

punção de bico automático



Ø mm	L mm	L1 mm	€	Unidade	Artigo
3	150	23	62,50	2	000320160

## 32AUR

ponteira de substituição



Ø mm	€	5	000320170
3	11,30		

## 33LT

punções de letras

- Para gravação em aço com resistência R até 80 kg/mm<sup>2</sup>
- Kit de 27 punções: letras A a Z + &



H mm	L mm	A mm	€	1	000330023
3	60	6,35	70,00		
4	63	7,93	85,50		
5	61	7,93	85,50		
6	68	9,52	105,00		
8	70	12,7	157,00		

## 33NR

punções de números

- Para gravação em aço com resistência R até 80 kg/mm<sup>2</sup>
- Kit de 9 punções: números 0 a 9



H mm	L mm	A mm	€	1	000330003
3	61	6,35	24,90		
4	62	7,93	30,00		
5	62	7,93	30,00		
6	68	9,52	36,50		
8	71	12,7	53,50		

## 34

escopros planos



L mm	A mm	L1 mm	€	5	000340001
125	14,5	45	11,90		
150	17,0	58	15,60		
175	21,5	68	22,60		

## 35

escopros planos série nervurada



L mm	A mm	€	5	000350001
100	14,5	14,00		
125	17,0	15,60		
150	20,5	19,50		
200	23,0	29,50		
250	28,5	42,00		
300	34,0	58,00		

## 35PM

escopros planos série nervurada com punho de protecção



L mm	A mm	€	2	000350014
200	23,0	44,00		
250	28,5	57,00		
300	34,0	73,50		

## 35PMR

punhos de protecção



L mm	€	1	000350024
200	14,70		
250	14,70		
300	15,40		

## 36

buris série normal



L mm	A mm	L1 mm	€	5	000360001
125	4	44	12,50		
150	6	53	14,70		

## 37

buris série nervurada



L mm	A mm	L1 mm	€	5	000370001
150	6	45	22,40		
200	8	55	32,00		

## 37PM

buril nervurado com punho de protecção



L mm	A mm	€	2	000370012
200	8	47,50		

## 37PMR

punho de protecção de substituição



L mm	€	1	000370022
200	15,40		



38/B6N



38/SP6

38/B6N	€	1	000380016
30: 2-3 mm	78,00		
32: 4 mm			
34: 125-150 mm			
36: 150 mm			
2002/BV6	10,00		1 020020000
38/SP6	92,50		1 000380009
30: 2-3 mm			
32: 4 mm			
34: 125-150 mm			
36: 150 mm			
38/SPV	26,00		1 000380019



# 42 A CHAVE ICÔNICA DA BETA

A nossa icônica chave 42 tem um novo formato. Uma forma estreita realçada por um perfil fino, mais leve ao toque, com espessura da cabeça reduzida ao mínimo, para permitir um fácil acesso a todos os espaços. A força, robustez e rapidez de utilização da chave Beta permite alcançar valores ainda melhores, proporcionando aos utilizadores a melhor ferramenta possível. O processo de fabrico desenvolve-se nas nossas fábricas de Sovico e Sulmona, com tecnologia de automação avançada e os melhores técnicos especializado

## RAPIDEZ

Um ângulo de 15° em relação ao eixo, para reduzir o ângulo de penetração

## RESISTÊNCIA

Força extraordinária: em caso de utilização incorreta, a chave deforma-se, sem quebrar de forma súbita

## HOMOGENIA

A prensagem realiza-se num produto semiacabado arredondado, que resulta na distribuição homogênea das fibras, prevenindo a formação de tensão interna

## ACESSIBILIDADE

Espessura reduzida para melhor alcance

## PROTEÇÃO

Revestimento cromado em níquel para maior resistência aos agentes externos e cumprimento dos exigentes requisitos dos testes de aderência da ISO 2819

## FORÇA

A chave, de comprimento maior que a maioria das concorrentes, permite alcançar apertos elevados com pouco esforço

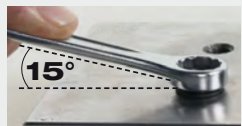

## ERGONOMIA

Luneta a 15° para proteção da mão. A sua forma é obtida a partir de um molde, ou seja, a curvatura não é conferida à posteriori



42

chaves mistas

Os valores de binário atingiram mais do dobro em relação aos requisitos a satisfazer ao abrigo da norma ISO 1711



DIN 3113 UNI-ISO 7738

mm	L mm	S1 mm	€	🔧	📦
5,5x5,5	95	3,4	8,60	5	000421005
6x6	95	3,4	8,70	5	000421006
7x7	105	3,6	8,80	5	000421007
8x8	116	3,9	9,20	5	000421008
9x9	127	4,2	9,50	5	000421009
10x10	137	4,5	9,80	5	000421010
11x11	148	4,8	10,40	5	000421011
12x12	158	5,1	10,50	5	000421012
13x13	169	5,6	10,60	5	000421013
14x14	180	5,7	12,20	5	000421014
15x15	190	6,0	13,40	5	000421015
16x16	201	6,3	13,90	5	000421016
17x17	212	6,8	14,50	5	000421017
18x18	222	7,0	15,50	5	000421018
19x19	233	7,5	16,00	5	000421019
20x20	243	7,7	18,00	3	000421020
21x21	254	7,9	19,40	3	000421021
22x22	264	8,3	19,90	3	000421022
23x23	275	8,5	21,60	3	000421023
24x24	285	8,7	22,80	3	000421024
25x25	296	8,7	24,10	2	000421025
26x26	307	8,9	26,00	2	000421026
27x27	317	9,1	28,00	2	000421027
28x28	328	9,3	28,50	2	000421028
29x29	338	9,5	31,50	2	000421029
30x30	349	9,7	33,00	2	000421030
32x32	370	10,1	36,50	2	000421032
34x34	391	10,5	69,00	1	000421034
35x35	412	10,7	74,00	1	000421035
36x36	412	10,7	77,00	1	000421036
38x38	433	11,3	85,00	1	000421038
41x41	465	12,0	96,00	1	000421041



	€	🔧	📦
42/B9N 6-7-8-10-11-13-14-17-19 mm	112,00	1	000421074
2002/BV9	12,70	1	020020030

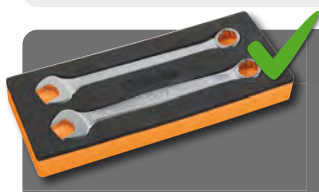

## ATENÇÃO!

A forma da chave 42 é perfeitamente compatível com todos os jogos e módulos da chave 42 estabelecida







	€	🔧	📦
<b>42/S14</b> 6-7-8-10-11-12-13-14 -15-16-17-19-22-24 mm	181,00	1	000421067
<b>42/S17</b> 6-7-8-9-10-11-12-13-14-15 16-17-18-19-20-21-22 mm	220,00	1	000421065
<b>42/S15</b> 6-7-8-10-11-12-13-14 17-19-22-24-27-30-32 mm	251,00	1	000421066
<b>42/S17X</b> 6-7-8-10-11-12-13-14- 15-16-17-19-21-22- 24-27-30 mm	261,00	1	000421068
<b>42/S26</b> 6-7-8-9-10-11-12-13-14 15-16-17-18-19-20-21 22-23-24-25-26-27-28 29-30-32 mm	472,00	1	000421070

### 42/SC9I-E

Conjunto de 9 chaves mistas com suporte compacto

Os valores de binário atingiram mais do dobro em relação aos requisitos a satisfazer ao abrigo da norma ISO 1711



	€	🔧	📦
<b>42/SC9I</b> 8-10-11-12-13-14-15-17-19 mm	115,00	1	000421087
<b>142/SCV9I</b>	10,90	1	001420103
<b>42/SC9E</b> 8-10-11-12-13-16-17-18-19 mm	119,00	1	000421088
<b>142/SCV9E</b>	10,90	1	001420104



	€	🔧	📦
<b>42/SP25</b> 6-7-8-9-10-11-12-13-14- 15-16-17-18-19-20-21- 22-23-24-25-26-27-28- 30-32 mm	505,00	1	000421085
<b>42/SPV2</b>	65,50	1	000420090



42/SP15

42/SPV...

	€	🔧	📦
<b>42/SP15</b> 6-7-8-9-10-11-12-13-14-15- 16-17-19-22-24 mm	197,00	1	000421078
<b>42/SPV7</b> 42: 8-10-11-13-14-17-19 mm 55: 6x7-8x9-10x11-12x13 14x15-16x17-18x19 mm	7,80	1	000420097
<b>42/SPV11</b> 42MP: 8-9-10-11-12-13 14-15-16-17-19 mm 142-142SN: 8-9-10-11-12-13 14-15-16-17-19 mm	10,90	1	000420100
<b>42/SPV15</b> 42: 6-7-8-9-10-11-12-13-14 15-16-17-19-22-24 mm	14,80	1	000420102



### 42AS

chaves mistas boca/luneta



🔧	L mm	€	🔧	📦
1/4x1/4	95	10,50	2	000421106
9/32x9/32	106	10,60	2	000421107
5/16x5/16	116	10,70	2	000421108
3/8x3/8	137	11,90	2	000421110
7/16x7/16	148	12,70	2	000421111
1/2x1/2	169	13,10	2	000421113
9/16x9/16	180	14,20	2	000421114
19/32x19/32	191	15,60	2	000421115
5/8x5/8	201	16,50	2	000421116
11/16x11/16	212	17,70	2	000421117
3/4x3/4	233	18,80	2	000421119
13/16x13/16	254	22,70	2	000421121
7/8x7/8	264	23,50	2	000421122
15/16x15/16	285	27,50	2	000421124
1x1	296	28,00	2	000421125
1.1/16x1.1/16	317	32,00	2	000421127
1.1/8x1.1/8	338	34,50	2	000421129
1.1/4x1.1/4	370	42,50	2	000421132
1.5/16x1.5/16	391	69,50	1	000421133
1.3/8x1.3/8	412	80,00	1	000421135
1.7/16x1.7/16	412	82,50	1	000421136
1.1/2x1.1/2	433	86,50	1	000421138



	€	🔧	📦
<b>42AS/B9N</b> 1/4-5/16-3/8-7/16-1/2 9/16-5/8-11/16-3/4 2002/BV9	138,00	1	000421159
	12,70	1	020020030



	€	🔧	📦
<b>42AS/13</b> 1/4-5/16-3/8-7/16-1/2-9/16-5/8 11/16-3/4-13/16-7/8-15/16-1	228,00	1	000421163
<b>42AS/16</b> 1/4-5/16-3/8-7/16-1/2-9/16-5/8 11/16-3/4-13/16-7/8-15/16-1- 1.1/16-1.1/8-1.1/4	337,00	1	000421166
<b>42AS/17</b> 1/4-9/32-5/16-3/8-7/16-1/2- 9/16-19/32-5/8-11/16-3/4- 13/16-7/8-15/16-1-1.1/16-1.1/8	320,00	1	000421168

## 42MP

chaves mistas boca/luneta em cromado brilhante



DIN 3113 UNI-ISO 7738

mm	L mm	€	📦	🚚
6x6	100	13,80	5	000421606
7x7	110	13,90	5	000421607
8x8	120	14,00	5	000421608
9x9	130	14,10	5	000421609
10x10	140	14,20	5	000421610
11x11	150	14,50	5	000421611
12x12	158	14,60	5	000421612
13x13	170	14,80	5	000421613
14x14	178	16,00	5	000421614
15x15	190	17,30	5	000421615
16x16	199	18,30	5	000421616
17x17	209	19,10	5	000421617
18x18	219	20,40	5	000421618
19x19	230	21,10	5	000421619
20x20	240	24,10	3	000421620
21x21	250	25,50	3	000421621
22x22	260	26,00	3	000421622
24x24	280	30,00	3	000421624
27x27	307	35,50	3	000421627
30x30	337	44,00	3	000421630
32x32	360	46,00	3	000421632



42MP/B9 6-7-8-10-11-13-14-17-19 mm	€ 153,00	📦 1	🚚 000421661
2002/BV9	12,70	📦 1	020020030



42MP/S17 6-7-8-9-10-11-12-13-14-15-16-17-18-19-20-21-22 mm	€ 302,00	📦 1	000421652
42MP/S21 6-7-8-9-10-11-12-13-14-15-16-17-18-19-20-21-22-24-27-30-32 mm	456,00	📦 1	000421653



## 42LMP

chaves mistas boca/luneta série longa em cromado brilhante



mm	L mm	€	📦	🚚
8x8	148	11,90	2	000420508
9x9	167	12,30	2	000420509
10x10	172	12,70	2	000420510
11x11	186	13,40	2	000420511
12x12	197	13,60	2	000420512
13x13	207	13,90	2	000420513
14x14	223	14,80	2	000420514
15x15	233	16,20	2	000420515
16x16	243	17,50	2	000420516
17x17	261	18,50	2	000420517
18x18	270	20,30	2	000420518
19x19	280	20,70	2	000420519
21x21	301	23,90	2	000420521
22x22	318	24,80	2	000420522
24x24	338	29,00	2	000420524
27x27	376	33,00	2	000420527
30x30	409	42,00	2	000420530
32x32	435	45,50	2	000420532



42LMP/S14 8-9-10-11-12-13-14-15-16-17-18-19-21-22 mm	€ 234,00	📦 1	000420551
42LMP/S18 8-9-10-11-12-13-14-15-16-17-18-19-21-22-24-27-30-32 mm	383,00	📦 1	000420552

## 42SLIM

chaves mistas boca/luneta com espessura reduzida



DIN 3113 UNI-ISO 7738

mm	L mm	S1 mm	€	📦	🚚
8x8	116	3,4	9,90	5	000420408
10x10	137	3,8	10,70	5	000420410
11x11	148	3,8	11,10	5	000420411
12x12	158	4,2	11,40	5	000420412
13x13	169	4,4	11,80	5	000420413
14x14	180	4,6	13,20	5	000420414
15x15	190	4,7	14,50	5	000420415
16x16	201	4,7	15,10	5	000420416
17x17	212	5,1	15,50	5	000420417
18x18	222	5,1	16,70	5	000420418
19x19	233	5,6	17,00	5	000420419



42SLIM/B8NI 10-11-12-13-14-15-17-19 mm	€ 118,00	📦 1	000420478
42SLIM/B8NE 10-11-12-13-16-17-18-19 mm	122,00	📦 1	000420479
2002/BV8	12,70	📦 1	020020020



42SLIM/S11 8-10-11-12-13-14-15-16-17-18-19 mm	€ 147,00	📦 1	000420471
--	----------	-----	-----------

## 45

chaves mistas boca/luneta serviço pesado



DIN 3113 UNI-ISO 7738

mm	L mm	€	📦	🚚
46x46	500	199,00	1	000450046
50x50	540	224,00	1	000450050
55x55	560	320,00	1	000450055
60x60	600	411,00	1	000450060
65x65	675	492,00	1	000450065
70x70	675	540,00	1	000450070
75x75	720	630,00	1	000450075
80x80	720	725,00	1	000450080

## 52

chaves de boca simples



UNI 6733 DIN 3114

mm	L mm	€	📦	🚚
10	119	9,10	5	000520010
11	119	9,30	5	000520011
12	119	9,60	5	000520012
13	145	10,80	5	000520013
14	145	11,10	5	000520014
15	145	11,40	5	000520015
16	159	12,30	5	000520016
17	159	12,40	5	000520017
18	159	13,20	5	000520018
19	175	14,40	5	000520019
20	175	15,30	5	000520020
21	175	15,80	5	000520021
22	196	17,80	2	000520022
23	196	18,30	2	000520023
24	196	18,70	2	000520024
25	215	21,00	2	000520025
26	215	21,40	2	000520026
27	215	21,50	2	000520027
28	240	24,80	2	000520028
30	240	25,00	2	000520030
32	270	30,00	2	000520032
34	270	33,00	1	000520034
35	295	38,00	1	000520035
36	295	38,00	1	000520036
38	295	42,50	1	000520038
40	335	52,00	1	000520040
41	335	52,00	1	000520041
42	335	58,00	1	000520042
45	370	66,50	1	000520045
46	370	66,50	1	000520046
48	370	76,50	1	000520048
50	415	89,50	1	000520050
52	415	100,00	1	000520052
55	415	104,00	1	000520055
60	490	132,00	1	000520060
65	490	134,00	1	000520065
70	490	152,00	1	000520070



chaves de boca simples DIN 894



mm	L mm	€		
36	317	28,00	1	000530036
38	320	30,50	1	000530038
41	342	36,00	1	000530041
46	396	43,50	1	000530046
50	412	68,50	1	000530050
55	457	78,50	1	000530055
60	492	97,00	1	000530060
65	528	115,00	1	000530065
70	572	133,00	1	000530070
75	608	167,00	1	000530075
80	645	204,00	1	000530080
85	690	248,00	1	000530085
90	690	294,00	1	000530090
95	847	410,00	1	000530095
100	847	433,00	1	000530100
105	1000	540,00	1	000530105
110	1000	585,00	1	000530110
115	1000	655,00	1	000530115
120	1000	740,00	1	000530120
125	1000	855,00	1	000530125
130	1000	915,00	1	000530130
135	1000	985,00	1	000530135

chaves de bocas



UNI-ISO 10102 DIN 3110

mm	L mm	€		
4x5	101	5,40	5	000550003
5x5,5	101	6,10	5	000550006
5,5x7	120	6,10	5	000550009
• 6x7	120	4,75	5	000550012
• 7x8	140	6,10	5	000550018
• 8x9	140	4,85	5	000550021
• 8x10	140	6,10	5	000550024
• 10x11	155	5,20	5	000550030
• 10x12	155	7,00	5	000550033
• 10x13	170	7,70	5	000550035
• 12x13	170	5,90	5	000550042
• 12x14	170	7,90	5	000550045
• 13x14	185	8,80	5	000550047
• 13x17	189	9,40	5	000550051
• 14x15	185	7,30	5	000550054
• 14x17	189	10,10	5	000550057
• 16x17	202	8,40	5	000550060
• 17x19	220	11,30	2	000550063
• 18x19	220	9,90	2	000550066
• 19x22	236	12,80	2	000550069
• 20x22	236	11,30	2	000550075
• 21x23	245	12,00	2	000550078
• 22x24	245	13,90	2	000550081
• 24x26	262	14,30	2	000550087
• 24x27	262	15,50	2	000550090
• 25x28	272	16,20	2	000550096
• 27x29	284	18,40	2	000550099
• 27x30	284	21,20	2	000550102
• 27x32	297	23,00	2	000550105
• 30x32	297	20,40	2	000550108
• 32x36	325	63,00	1	000550114
• 34x36	325	63,00	1	000550117
• 35x38	375	69,50	1	000550120
• 36x41	375	72,50	1	000550123
• 41x46	425	83,00	1	000550129
• 46x50	475	103,00	1	000550132
• 50x55	500	120,00	1	000550135
• 55x60	500	126,00	1	000550138



	€		
<b>55/B8N</b> 6x7-8x9-10x11-12x13 14x15-16x17-18x19 20x22 mm	68,00	1	000550160
<b>2002/BV8</b>	12,70	1	020020020
<b>55/B12N</b> 6x7-8x9-10x11-12x13- 14x15-16x17-18x19- 20x22-21x23-24x26- 25x28-30x32 mm	138,00	1	000550164
<b>2002/BV12</b>	21,10	1	020020040



	€		
<b>55/S8</b> 6x7-8x9-10x11-12x13 14x15-16x17-18x19 20x22 mm	57,50	1	000550174

	€		
<b>55/S12</b> 6x7-8x9-10x11-12x13 14x15-16x17-18x19 20x22-21x23-24x26 25x28-30x32 mm	121,00	1	000550178

	€		
<b>55/S12X</b> 6x7-8x9-10x11-12x13 14x15-16x17-18x19 20x22-21x23-24x27 25x28-30x32 mm	122,00	1	000550179

	€		
<b>55/S13</b> 6x7-8x9-10x11-12x13 14x15-16x17-18x19 20x22-21x23-24x26 25x28-27x29-30x32 mm	139,00	1	000550182



55/SP7



55/SP13

	€		
<b>55/SP7</b> 6x7-8x9-10x11-12x13 14x15-16x17-18x19 mm	48,50	1	000550167

	€		
<b>42/SPV7</b>	7,80	1	000420097

	€		
<b>55: 6x7-8x9-10x11-12x13</b> 14x15-16x17-18x19 mm			

	€		
<b>55/SP13</b> 6x7-8x9-10x11-12x13 14x15-16x17-18x19 20x22-21x23-24x26 25x28-27x29-30x32 mm	172,00	1	000550186

	€		
<b>55/SPV</b>	33,50	1	000550190



chaves de bocas



	L mm	€		
<b>1/4x9/32</b>	120	6,40	2	000550203
<b>1/4x5/16</b>	120	6,40	2	000550206
<b>5/16x11/32</b>	140	6,90	2	000550209
<b>5/16x3/8</b>	140	6,90	2	000550212
<b>3/8x7/16</b>	155	7,50	2	000550215
<b>7/16x1/2</b>	170	8,20	2	000550218
<b>1/2x9/16</b>	170	8,80	2	000550221
<b>9/16x5/8</b>	185	9,70	2	000550224
<b>19/32x11/16</b>	189	11,80	2	000550227
<b>5/8x11/16</b>	202	11,80	2	000550230
<b>5/8x3/4</b>	202	13,30	2	000550233
<b>11/16x13/16</b>	220	13,80	2	000550242
<b>3/4x7/8</b>	236	14,90	2	000550245
<b>25/32x13/16</b>	236	14,90	2	000550244
<b>7/8x15/16</b>	245	16,10	2	000550251
<b>15/16x1</b>	262	20,40	1	000550257
<b>1x1.1/8</b>	272	21,50	1	000550259
<b>1.1/16x1.1/4</b>	284	28,00	1	000550267
<b>1.1/8x1.5/16</b>	297	28,00	1	000550266
<b>1.5/16x1.1/2</b>	325	74,00	1	000550269
<b>1.3/8x1.1/2</b>	375	81,50	1	000550272
<b>1.7/16x1.5/8</b>	375	81,50	1	000550275



	€		
<b>55AS/5</b> 5/16x11/32-3/8x7/16 1/2x9/16-5/8x11/16 3/4x7/8	49,50	1	000550290

	€		
<b>55AS/8</b> 1/4x9/32-5/16x11/32-3/8x7/16- 1/2x9/16-9/16x5/8-5/8x11/16- 11/16x13/16-3/4x7/8	80,00	1	000550296

	€		
<b>55AS/12</b> 1/4x9/32-5/16x11/32-3/8x7/16-1 /2x9/16-9/16x5/8-5/8x11/16- 11/16x13/16-25/32x13/16-3/4x7/8- 15/16x1-1x1.1/8-1.1/16x1.1/4	164,00	1	000550298

chaves de boca, série pancada



DIN 133

	L mm	€		
<b>24</b>	177	35,50	1	000580024
<b>27</b>	180	37,00	1	000580027
<b>30</b>	190	41,00	1	000580030
<b>32</b>	190	43,00	1	000580032
<b>34</b>	200	54,00	1	000580034
<b>36</b>	215	56,00	1	000580036
<b>41</b>	235	66,00	1	000580041
<b>46</b>	255	88,50	1	000580046
<b>50</b>	275	99,50	1	000580050
<b>55</b>	300	119,00	1	000580055
<b>60</b>	320	131,00	1	000580060
<b>65</b>	342	171,00	1	000580065
<b>70</b>	375	221,00	1	000580070
<b>75</b>	375	241,00	1	000580075
<b>80</b>	408	366,00	1	000580080



mm	L mm	€		
85	408	410,00	1	000580085
90	445	472,00	1	000580090
95	445	486,00	1	000580095
100	485	675,00	1	000580100
*105	485	760,00	1	000580105
*110	510	830,00	1	000580110
*115	510	950,00	1	000580115
*120	545	975,00	1	000580120
*125	545	1.120,00	1	000580125
*130	575	1.510,00	1	000580130
*135	575	1.590,00	1	000580135
*140	575	1.720,00	1	000580140
*145	640	2.350,00	1	000580145
*150	640	2.450,00	1	000580150
*155	640	2.680,00	1	000580155
*160	640	2.940,00	1	000580160
*165	715	3.140,00	1	000580165
*170	715	4.290,00	1	000580170
*175	715	4.540,00	1	000580175
*180	715	4.920,00	1	000580180
*185	715	5.050,00	1	000580185
*190	800	5.550,00	1	000580190
*195	800	5.850,00	1	000580195
*200	800	6.150,00	1	000580200
*210	800	7.650,00	1	000580210
*220	800	9.850,00	1	000580220
*230	800	12.000,00	1	000580230

### 73

chaves de bocas de pequenas dimensões



UNI 6737

mm	L mm	€		
4x4	78	8,10	5	000730040
4,5x4,5	78	8,10	5	000730045
5x5	78	8,10	5	000730050
5,5x5,5	86	8,70	5	000730055
6x6	86	8,70	5	000730060
7x7	86	8,70	5	000730070
8x8	97	9,10	5	000730080
9x9	97	9,10	5	000730090
10x10	108	9,90	5	000730100
11x11	108	9,90	5	000730110
12x12	124	11,40	5	000730120
13x13	124	11,40	5	000730130
14x14	124	11,40	5	000730140



73/B13N	133,00	1	000730202
4-4,5-5-5,5-6-7-8-9			
10-11-12-13-14 mm			
2002/BV13	12,70	1	020020050



73/S13	122,00	1	000730210
4-4,5-5-5,5-6-7-8-9			
10-11-12-13-14 mm			

### 78

chaves de luneta de 12 facas série pancada



DIN 7444

mm	L mm	€		
24	162	35,50	1	000780024
27	180	41,50	1	000780027
30	190	49,00	1	000780030
32	190	52,50	1	000780032
34	200	60,00	1	000780034
36	205	65,00	1	000780036
41	225	84,00	1	000780041
46	235	94,00	1	000780046
50	250	112,00	1	000780050
55	265	127,00	1	000780055
60	275	155,00	1	000780060
65	295	196,00	1	000780065
70	325	197,00	1	000780070
75	325	234,00	1	000780075
80	350	358,00	1	000780080
85	350	392,00	1	000780085
90	390	479,00	1	000780090
95	390	555,00	1	000780095
100	420	615,00	1	000780100
105	420	725,00	1	000780105
110	450	790,00	1	000780110
115	450	900,00	1	000780115
*120	490	1.240,00	1	000780120
*125	480	1.670,00	1	000780125
*130	520	1.930,00	1	000780130
*135	520	2.070,00	1	000780135
*140	520	2.350,00	1	000780140
*145	580	2.960,00	1	000780145
*150	580	3.100,00	1	000780150
*155	580	3.570,00	1	000780155
*160	650	3.660,00	1	000780160
*165	650	3.890,00	1	000780165
*170	650	4.660,00	1	000780170
*175	650	5.050,00	1	000780175
*180	650	5.550,00	1	000780180
*185	695	5.750,00	1	000780185
*190	695	6.250,00	1	000780190
*195	695	6.250,00	1	000780195
*200	695	6.350,00	1	000780200
*210	740	6.800,00	1	000780210
*215	740	7.600,00	1	000780215
*220	740	8.350,00	1	000780220
*230	740	10.400,00	1	000780230

### 78AS

chave de luneta de pancada



"	L mm	€		
*1.1/16	180	50,50	1	000780327
*1.1/8	190	50,50	1	000780329
*1.3/16	190	50,50	1	000780330
*1.1/4	197	54,50	1	000780332
*1.5/16	197	56,50	1	000780333
*1.3/8	223	60,00	1	000780335
*1.7/16	223	72,50	1	000780336
*1.1/2	223	75,00	1	000780338
*1.5/8	223	85,50	1	000780341
*1.11/16	225	89,00	1	000780343
*1.13/16	240	98,50	1	000780346
*1.7/8	250	99,50	1	000780348
*2	250	114,00	1	000780350
*2.1/16	250	118,00	1	000780352
*2.3/16	275	124,00	1	000780355
*2.3/8	270	168,00	1	000780360
*2.9/16	302	186,00	1	000780365
*2.3/4	350	202,00	1	000780370
*2.15/16	350	233,00	1	000780375
*3.1/8	354	385,00	1	000780380

### 80

chaves de caixa articuladas com 12 facas



mm	L mm	€		
6x7	170	39,50	3	000800006
8x9	176	40,50	3	000800008
8x10	179	40,50	3	000800009
10x11	182	42,50	3	000800010
12x13	228	48,50	3	000800012
14x15	232	49,00	3	000800014
13x17	231	52,50	3	000800015
16x17	234	52,50	2	000800016
18x19	285	65,00	2	000800018
19x22	287	68,50	2	000800019
20x22	289	68,50	2	000800020
21x23	289	69,50	2	000800021
24x27	405	114,00	2	000800024
30x32	413	121,00	2	000800030



80/S8	405,00	1	000800051
6x7-8x9-10x11-12x13-14x15			
16x17-18x19-20x22 mm			
80/S11	710,00	1	000800056
6x7-8x9-10x11-12x13			
14x15-16x17-18x19-20x22			
21x23-24x27-30x32 mm			

### 83

chaves curvas de lunetas para motores de arranque



ISO 3318

mm	L mm	€		
8x10	126	20,00	3	000830008
10x12	137	21,00	3	000830010
11x13	138	21,50	3	000830011
14x17	183	27,00	3	000830014
15x17	184	30,50	2	000830015
16x18	196	33,50	2	000830016
19x22	231	42,50	2	000830019



83/S3	91,50	1	000830081
11x13-14x17-19x22 mm			
83/S5	149,00	1	000830085
10x12-11x13-15x17-			
16x18-19x22 mm			

## 83AS

chaves curvas de lunetas para motores de arranque



mm	L mm	€	U	U
7/16x1/2	138	25,50	2	000830111
9/16x5/8	183	30,50	2	000830114
3/4x7/8	230	48,00	2	000830119



<b>83AS/3</b>	<b>105,00</b>	<b>1</b>	<b>000830181</b>
7/16x1/2-9/16x5/8 3/4x7/8			

## 88

chaves de luneta duplas direitas, série extralonga



mm	L mm	€	U	U
8x10	235	22,30	2	000880008
12x14	330	26,50	2	000880012
13x15	330	26,50	2	000880013
16x18	405	36,50	2	000880016
17x19	405	36,50	2	000880017
21x23	435	42,00	2	000880021
22x24	435	42,00	2	000880022



<b>88/S7</b>	<b>232,00</b>	<b>1</b>	<b>000880107</b>
8x10-12x14-13x15-16x18- 17x19-21x23-22x24 mm			

## 90

chaves de lunetas com curvatura profunda



DIN 838 ISO 10104

mm	L mm	€	U	U
6x7	165	11,10	5	000900006
8x9	180	11,80	5	000900012
8x10	180	13,90	5	000900015
10x11	195	13,00	5	000900018
10x12	195	14,10	5	000900021
11x13	215	15,50	5	000900024
12x13	215	14,20	5	000900027
12x14	215	16,30	5	000900030
14x15	230	15,50	5	000900033
14x17	250	19,20	5	000900036
16x17	250	17,70	5	000900039
17x19	265	22,80	5	000900042
18x19	265	20,70	5	000900045
19x22	285	25,50	3	000900048
20x22	285	23,80	3	000900051
21x23	305	27,00	2	000900057
22x24	305	29,00	2	000900060
24x26	325	30,00	2	000900063
24x27	325	33,50	2	000900067
25x28	340	36,00	2	000900070
27x29	355	38,50	2	000900073
27x30	355	42,00	2	000900076
27x32	375	47,00	2	000900078
30x32	375	43,50	2	000900080
32x36	395	65,00	1	000900088
34x36	415	77,00	1	000900089
35x38	415	78,00	1	000900091
36x41	435	89,00	1	000900094
41x46	460	128,00	1	000900097
46x50	500	169,00	1	000900100



<b>90/B8N</b>	<b>141,00</b>	<b>1</b>	<b>000900156</b>
6x7-8x9-10x11-12x13- 14x15-16x17-18x19- 20x22 mm			
<b>2002/BV8</b>	<b>12,70</b>	<b>1</b>	<b>020020020</b>



<b>90/S8</b>	<b>128,00</b>	<b>1</b>	<b>000900162</b>
6x7-8x9-10x11-12x13 14x15-16x17-18x19 20x22 mm			
<b>90/S12</b>	<b>264,00</b>	<b>1</b>	<b>000900166</b>
6x7-8x9-10x11-12x13 14x15-16x17-18x19 20x22-21x23-24x26 25x28-30x32 mm			
<b>90/S12X</b>	<b>268,00</b>	<b>1</b>	<b>000900167</b>
6x7-8x9-10x11-12x13 14x15-16x17-18x19 20x22-21x23-24x27 25x28-30x32 mm			
<b>90/S13</b>	<b>302,00</b>	<b>1</b>	<b>000900170</b>
6x7-8x9-10x11-12x13 14x15-16x17-18x19 20x22-21x23-24x26 25x28-27x29-30x32 mm			



<b>90/SP13</b>	<b>343,00</b>	<b>1</b>	<b>000900174</b>
6x7-8x9-10x11-12x13 14x15-16x17-18x19 20x22-21x23-24x26 25x28-27x29-30x32 mm			
<b>55/SPV</b>	<b>33,50</b>	<b>1</b>	<b>000550190</b>

## 90AS

chaves de lunetas com curvatura profunda



mm	L mm	€	U	U
1/4x5/16	165	12,70	2	000900203
5/16x11/32	180	13,70	2	000900206
5/16x3/8	180	14,00	2	000900209
3/8x7/16	195	14,20	2	000900212
7/16x1/2	215	16,00	2	000900215
1/2x9/16	230	18,30	2	000900218
9/16x5/8	230	18,30	2	000900221
19/32x11/16	250	19,90	2	000900222
5/8x11/16	250	20,70	2	000900224
5/8x3/4	265	24,40	2	000900227
11/16x3/4	265	24,40	1	000900230
11/16x13/16	265	24,40	1	000900233
3/4x25/32	265	28,50	1	000900235
3/4x7/8	285	28,50	1	000900237
13/16x7/8	285	29,00	1	000900240
7/8x15/16	305	29,00	1	000900243
15/16x1	325	35,00	1	000900252
1.1/16x1.1/4	375	50,50	1	000900258
1.1/8x1.5/16	375	51,00	1	000900261



<b>90AS/8</b>	<b>168,00</b>	<b>1</b>	<b>000900298</b>
1/4x5/16-5/16x11/32 3/8x7/16-1/2x9/16 5/8x11/16-11/16x3/4 13/16x7/8-15/16x1			
<b>90AS/10</b>	<b>269,00</b>	<b>1</b>	<b>000900300</b>
1/4x5/16-5/16x11/32 3/8x7/16-1/2x9/16 5/8x11/16-11/16x3/4 13/16x7/8-15/16x1 1.1/16x1.1/4-1.1/8x1.5/16			

**Beta**

**Beta**

## 91

chaves de luneta inclinada para serviços pesados



Ø mm	Ø mm	€		
24	38	63,50	1	000910024
27	41	65,50	1	000910027
30	48	70,50	1	000910030
32	49	76,00	1	000910032
36	54	87,00	1	000910036
41	62	104,00	1	000910041
46	69	121,00	1	000910046
50	76	138,00	1	000910050
55	81	154,00	1	000910055
60	90	192,00	1	000910060
65	98	215,00	1	000910065
70	105	242,00	1	000910070
75	110	277,00	1	000910075
80	125	318,00	1	000910080
85	125	332,00	1	000910085
90	140	595,00	1	000910090
95	140	650,00	1	000910095
100	143	690,00	1	000910100
105	146	770,00	1	000910105

## 92

cabo tubular para a chave ref. 91



	L mm	91 mm	Ø mm	€		
92/1	460	24÷30	19	38,00	1	000920010
92/2	610	32÷41	22	58,50	1	000920020
92/3	760	46÷55	25	83,00	1	000920030
92/4	860	60÷105	30	111,00	1	000920040

## 93

chave de lunetas com curvatura profunda especial para andaimes



Ø mm	L mm	€		
21x22	310	45,50	3	000930021

## 93C

roquete de dupla face, com curvatura, para parafusos de andaimes



Ø mm	L mm	€		
17x19	310	51,50	1	000930117
19x22	310	55,50	1	000930119
19x24	365	68,00	1	000930120
21x22	310	62,00	1	000930121
36x38	445	104,00	1	000930136

## 94

chaves de lunetas abertas



DIN 3118

Ø mm	L mm	€		
8x10	140	19,20	2	000940008
9x11	153	20,00	2	000940009
10x11	153	21,10	2	000940010
11x13	175	21,70	2	000940011
12x14	175	23,00	2	000940012
13x15	175	23,00	2	000940013
14x15	175	27,00	2	000940014
14x17	195	28,00	2	000940015
17x19	212	28,50	2	000940017
19x22	228	30,00	2	000940019
22x24	242	37,00	2	000940022
24x27	260	40,50	2	000940024
30x32	300	52,50	2	000940030
36x41	320	89,50	1	000940036



94/S6 144,00 1 000940050

8x10-10x11-11x13-12x14-17x19-19x22 mm

94/S10 294,00 1 000940052

8x10-9x11-10x11-11x13-12x14-17x19-19x22-22x24-24x27-30x32 mm

## 95

chaves de lunetas direitas



DIN 837 ISO 10103

Ø mm	L mm	€		
6x7	120	12,60	3	000950161
8x9	135	13,60	3	000950162
10x11	150	15,30	3	000950163
12x13	165	16,60	3	000950164
14x15	185	17,50	3	000950165
16x17	210	18,60	3	000950166
17x19	225	21,50	3	000950167
18x19	225	21,50	2	000950168
20x22	240	24,40	2	000950169
21x23	255	25,50	2	000950170
24x26	270	27,00	2	000950171
25x28	285	32,50	2	000950172
27x29	315	33,50	2	000950173
30x32	335	37,50	2	000950174



95/S8 140,00 1 000950177

6x7-8x9-10x11-12x13-14x15-16x17-18x19-20x22 mm

95/S13 296,00 1 000950179

6x7-8x9-10x11-12x13-14x15-16x17-18x19-20x22-21x23-24x26-25x28-27x29-30x32 mm

## 95FTX

chaves de lunetas direitas, para parafusos com perfil Torx®



Ø mm	L mm	€		
E6xE8	115	13,00	2	000950306
E10xE12	143	13,70	2	000950310
E14xE18	177	15,50	2	000950314
E20xE24	224	21,10	2	000950320



	€		
95FTX/S4	63,50	1	000950325

E6xE8-E10xE12-E14xE18-E20xE24





# CHAVES MACHO SEXTAVADAS

As chaves macho sextavadas da Beta são concebidas para trabalhos longos e precisos.

A ampla gama cobre todos os requisitos de utilização: extracurtas, curtas, longas, extralongas, com ponta de bola, em T, ou com punho de aperto elevado, estas chaves incluem-se nos produtos que mais se destacam na gama Beta, sem rival à altura no mercado.

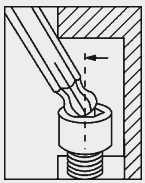

As chaves ponta de bola permitem trabalhar a um ângulo até 30° do eixo do parafuso.

As chaves são fornecidas numa bolsa para rápida identificação do tamanho desejado. Quando fechada, garante que as chaves estão protegidas e não se perdem, mesmo as de menor dimensão. A versão colorida combina as características excecionais das chaves standard com a identificação imediata do tamanho desejado, para facilitar o trabalho diário.



## 96

chaves macho hexagonal cromadas



ISO 2936

mm	L	L1	€	🔧	📦
0,9	35	8	1,11	20	000960013
1,3	39	10	1,11	20	000960014
1,5	45	15	1,11	20	000960015
2	50	17	1,18	20	000960020
2,5	57	20	1,18	20	000960025
3	64	22	1,38	20	000960030
3,5	68	25	1,65	20	000960035
4	72	28	1,72	20	000960040
4,5	78	30	1,78	20	000960045
5	83	32	1,84	20	000960050
5,5	88	35	2,32	20	000960055
6	94	37	2,32	20	000960060
7	99	40	2,88	10	000960070
8	105	43	3,40	10	000960080
9	111	46	4,00	10	000960090
10	119	49	4,75	10	000960100
11	126	52	6,00	10	000960110
12	134	56	7,20	10	000960120
13	142	62	9,20	10	000960130
14	151	69	10,70	10	000960140
16	165	75	15,70	5	000960160
17	174	79	16,50	5	000960170
19	196	88	23,00	5	000960190
22	216	100	36,00	3	000960220
24	242	112	47,50	1	000960240
27	271	125	63,00	1	000960270
30	309	140	84,50	1	000960300
32	341	155	112,00	1	000960312
36	385	174	161,00	1	000960316

## 96



96/ST6  
2,5-3-4-5-6-8 mm € 16,10 3 000960370

## 96



96/BGS7  
1,5-2-2,5-3-4-5-6 mm € 35,50 1 000960367

## 96



96/BG7  
2,5-3-4-5-6-8-10 mm € 37,50 1 000960368

## 96



mm	€	🔧	📦
96/B8 2-2,5-3-4-5-6-8-10 mm	20,00	5	000960386
96/B10 1,5-2-2,5-3-4-5-6-8-10-12 mm	28,50	5	000960380
96N/BV	2,17	1	000960651

## 96



mm	€	🔧	📦
96/SC9 1,5-2-2,5-3-4-5-6-8-10 mm	23,80	1	000960374
96/SCV	4,85	1	000960985

## 96



mm	€	🔧	📦
96/SC12 2-2,5-3-3,5-4-4,5-5-6-7-8-9-10 mm	34,00	1	000960395
96/SCV12	5,80	1	000960975

## 96N

chaves macho hexagonal, brunidas

## 96



ISO 2936

mm	L mm	L1 mm	€	🔧	📦
0,9	32	10	0,56	20	000960409
1,3	44	12	0,56	20	000960413
1,5	46	15	0,59	20	000960415
2	51	17	0,62	20	000960420
2,5	57	20	0,64	20	000960425
3	64	22	0,72	20	000960430
3,5	68	25	0,86	20	000960435
4	72	28	0,98	20	000960440
4,5	78	30	1,07	20	000960445
5	83	32	1,12	20	000960450
6	94	37	1,41	20	000960460
7	99	40	1,87	10	000960470
8	105	43	2,22	10	000960480
9	111	46	2,90	10	000960490
10	119	49	3,45	10	000960500
11	126	52	4,25	10	000960510
12	134	56	5,20	10	000960520
13	142	62	7,00	10	000960530
14	151	69	7,80	10	000960540
16	165	72	11,80	5	000960560
17	174	79	12,70	5	000960570
19	194	88	17,20	5	000960590
22	216	99	31,50	1	000960592
24	242	111	41,50	1	000960594



**96N/ST6** € 11,30 3 000960640  
2,5-3-4-5-6-8 mm



**96N/G7** € 29,50 3 000960645  
2,5-3-4-5-6-8-10 mm  
**96N/G7A** € 20,70 3 000960643  
1,5-2-2,5-3-4-5-6 mm



**96N/B10** € 19,10 5 000960650  
1,5-2-2,5-3-4-5-6  
8-10-12 mm  
**96N/BV** € 2,17 1 000960651



**96N/SC9** € 16,60 1 000960644  
1,5-2-2,5-3-4-5-6-8-10 mm  
**96N/SCV** € 4,85 1 000960986



**96N/SC12** € 23,70 1 000960661  
2-2,5-3-3,5-4-4,5-5  
6-7-8-9-10 mm  
**96N/SCV12** € 5,80 1 000960976



**96C-AS/SC9** € 40,50 1 000961753  
1/16-3/32-1/8-5/32-3/16-  
7/32-1/4-5/16-3/8

**96AS**  
chaves macho hexagonal, brunidas



"	L mm	L1 mm	€		
1/30 (0,035")	44	14	0,99	20	000960698
1/20 (0,050")	44	15	0,99	20	000960701
1/16	46	16	1,07	20	000960702
5/64	50	18	1,32	20	000960704
3/32	53	19	1,52	20	000960706
7/64	57	21	1,56	20	000960708
1/8	60	22	1,58	20	000960710
9/64	64	24	1,89	20	000960712
5/32	68	25	1,95	20	000960714
3/16	75	29	2,17	20	000960716
7/32	82	32	2,43	20	000960718
1/4	89	35	2,84	20	000960720
5/16	103	40	3,55	10	000960724
3/8	117	44	4,30	10	000960728
7/16	132	49	6,30	10	000960730
1/2	149	54	8,00	10	000960732
9/16	151	69	13,00	2	000960734



**96AS/SC9** € 26,50 1 000960743  
1/16-3/32-1/8-5/32-3/16  
7/32-1/4-5/16-3/8  
**96AS/SCV** € 4,85 1 000960744



**96AS/T7** € 21,30 3 000960740  
3/32-1/8-5/32  
3/16-7/32-1/4-5/16



**96AS/BG7** € 37,50 1 000960747  
3/32-1/8-5/32-3/16  
1/4-5/16-3/8



**96AS/B11** € 26,00 1 000960749  
1/20-1/16-5/64-3/32  
1/8-5/32-3/16-7/32  
1/4-5/16-3/8  
**96N/BV** € 2,17 1 000960651

**96LC**  
chaves macho hexagonal  
série longa, cromadas



ISO 2936

mm	L mm	L1 mm	€		
2	101	17	2,11	20	000960320
2,5	113	20	2,26	20	000960321
3	127	22	2,46	20	000960322
3,5	138	25	2,52	20	000960323
4	142	28	2,74	20	000960324
4,5	154	28	3,20	20	000960325
5	163	32	3,50	20	000960326
6	184	37	3,75	20	000960327
7	194	40	4,30	10	000960328
8	205	43	5,30	10	000960329
9	216	46	5,90	10	000960330
10	231	49	7,60	10	000960331
12	259	56	9,40	10	000960332



**96LC/SC8** € 34,50 1 000960334  
2-2,5-3-4-5-6-8-10 mm  
**96LC/SCV** € 4,85 1 000960983



**96LC/SC12** € 51,50 1 000960337  
2-2,5-3-3,5-4-4,5-5  
6-7-8-9-10 mm  
**96LC/SCV12** € 5,80 1 000960977



## 96L

chaves macho hexagonal  
série longa, brunidas



ISO 2936

mm	L mm	L1 mm	€	🔧	📦
2	99	15	1,49	20	000960820
2,5	110	17	1,55	20	000960825
3	124	19	1,75	20	000960830
3,5	135	21	1,89	20	000960835
4	138	24	2,09	20	000960840
4,5	150	25	2,43	20	000960845
5	158	27	2,56	20	000960850
6	178	31	2,90	20	000960860
7	187	33	3,70	10	000960870
8	197	35	4,70	10	000960880
9	207	37	5,30	10	000960890
10	221	39	7,00	10	000960900
12	247	44	9,00	10	000960920



96L/SC8	€ 29,00	🔧 1	📦 000960924
2-2,5-3-4-5-6-8-10 mm			
96L/SCV	€ 4,85	🔧 1	📦 000960987



96L/SC12	€ 43,00	🔧 1	📦 000960929
2-2,5-3-3,5-4-4,5-5-6-7-8-9-10 mm			
96L/SCV12	€ 5,80	🔧 1	📦 000960978

## 96BP-CL

chaves de caixa sextavadas, macho, com  
ponta esférica, cromadas, coloridas



mm	L mm	L1 mm	€	🔧	📦
1,5	91	16	3,30	5	000961600
2	102	17	3,70	5	000961601
2,5	113	21	4,10	5	000961602
3	128	23	4,60	5	000961603
4	143	28	5,10	5	000961604
5	163	33	5,60	5	000961605
6	185	37	7,10	5	000961606
8	206	43	9,60	2	000961608
10	231	50	12,70	2	000961610



96BP-CL/SC9	€ 60,50	🔧 1	📦 000961619
1,5-2-2,5-3-4-5-6-8-10 mm			
96BP-CL/SCV	€ 4,85	🔧 1	📦 000961629

## 96BPC

chaves macho hexagonal  
com uma extremidade esférica  
cromadas

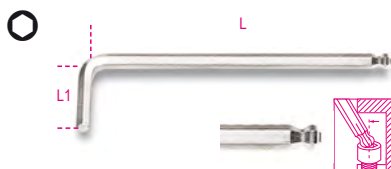

mm	L mm	L1 mm	€	🔧	📦
1,5	79	13	2,50	10	000960340
2	84	15	2,63	10	000960341
2,5	89	17	2,76	10	000960342
3	99	19	2,95	10	000960343
4	108	24	3,40	10	000960344
5	126	27	4,10	10	000960345
6	148	31	5,90	10	000960346
7	157	33	7,70	5	000960353
8	168	35	7,80	5	000960347
10	187	39	12,70	5	000960348
12	220	55	16,30	5	000960352



96BPC/SC9	€ 49,50	🔧 1	📦 000960354
1,5-2-2,5-3-4-5-6-8-10 mm			
96BPC/SCV	€ 4,85	🔧 1	📦 000960984

## 96BP

chaves macho hexagonal com uma  
extremidade esférica, brunidas

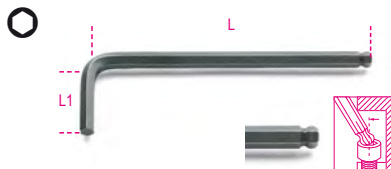

mm	L mm	L1 mm	€	🔧	📦
1,5	79	13	1,89	10	000960960
2	84	15	2,02	10	000960961
2,5	89	17	2,09	10	000960962
3	99	19	2,17	10	000960963
4	108	24	2,50	10	000960965
5	126	27	3,30	10	000960967
6	148	31	4,75	10	000960968
8	168	35	6,90	5	000960970
10	187	39	11,60	5	000960972
12	220	55	17,30	5	000960973



96BP/SC9	€ 42,00	🔧 1	📦 000960974
1,5-2-2,5-3-4-5-6-8-10 mm			
96BP/SCV	€ 4,85	🔧 1	📦 000960988

## 96BP-HO/SC9

jogo de 9 chaves sextavadas macho com  
ponta de bola, com sistema de fixação por  
parafuso



96BP-HO/SC9	€ 53,50	🔧 1	📦 000961254
1,5-2-2,5-3-4-5-6-8-10 mm			

## 96LBP

chave sextavada ponta de bola, modelo extra  
longo

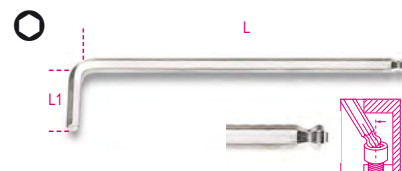

mm	L mm	L1 mm	€	🔧	📦
1,5	90	15	2,90	5	000961340
2	100	17	3,05	5	000961341
2,5	112	20	3,25	5	000961342
3	127	22	3,40	5	000961343
4	144	27	4,15	5	000961344
5	163	32	4,95	5	000961345
6	184	37	6,90	5	000961346
8	204	44	9,50	2	000961348
10	230	49	15,10	2	000961350



96LBP/SC9	€ 58,00	🔧 1	📦 000961354
1,5-2-2,5-3-4-5-6-8-10 mm			
96LBP/SCV	€ 4,85	🔧 1	📦 000961984





## 96BP/AS

chaves macho hexagonal com uma extremidade esférica, brunidas

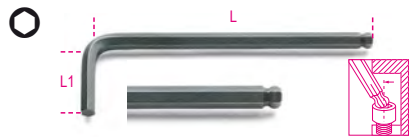

"	L mm	L1 mm	€	🔧	📄
3/32	89	17	2,29	10	000960989
1/8	98	18	2,43	10	000960990
5/32	108	24	2,90	10	000960991
3/16	126	26	3,30	10	000960992
7/32	139	28	4,80	10	000960993
1/4	152	31	5,30	10	000960994
5/16	168	34	7,00	5	000960995
3/8	190	39	11,50	5	000960996



96BP-AS/SC9 1/16-3/32-1/8-5/32-3/16	€ 45,50	🔧 1	📄 000961000
7/32-1/4-5/16-3/8	€ 4,85	🔧 1	📄 000961001



96BP-AS/8 3/32-1/8-5/32-3/16-7/32	€ 41,50	🔧 1	📄 000960997
1/4-5/16-3/8	€ 2,17	🔧 1	📄 000960998

## 96BPA

chave sextavada ponta de bola, 110°, modelo extra curto



mm	L mm	L1 mm	€	🔧	📄
1,5	71	9	2,70	5	000961960
2	86	11	2,84	5	000961961
2,5	96	13	2,95	5	000961962
3	104	15	3,25	5	000961963
4	116	17	3,85	5	000961964
5	132	19	4,65	5	000961965
6	155	21	6,80	5	000961966
8	176	24	8,90	2	000961968
10	200	27	13,90	2	000961970



96BPA/SC9 1,5-2-2,5-3-4-5-6-8-10 mm	€ 54,50	🔧 1	📄 000961974
96BPA/SCV	€ 4,85	🔧 1	📄 000961988

## 96T CHAVES MACHO EXTAVADAS com punho de aperto elevado

Rapidez e facilidade de utilização

O punho de pequenas dimensões é perfeitamente equilibrado, o que lhe permite rodar rapidamente na palma da mão.

O formato ergonómico permite a aplicação de apertos extremamente elevados.

As extremidades sextavadas foram concebidas para transmitir o máximo aperto possível ao parafuso.

O eixo redondo possui uma estrutura homogénea em comparação com o eixo sextavado, o que proporciona força adicional.



O eixo atravessa o punho

## 96T

chaves macho sextavadas com punho

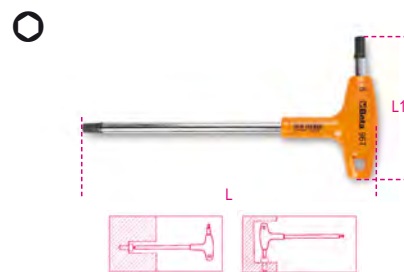

mm	L mm	L1 mm	€	🔧	📄
2	139	52	13,00	5	000960934
2,5	153	55	13,00	5	000960935
3	153	55	13,70	5	000960936
3,5	179	70	14,10	5	000960937
4	179	70	14,10	5	000960938
4,5	200	84	14,40	5	000960939
5	200	84	14,40	5	000960940
6	221	103	16,50	5	000960941
7	236	106	18,10	3	000960942
8	255	117	21,10	3	000960943
10	285	132	24,20	3	000960945



96T/S5P 2,5-3-4-5-6 mm	€ 71,50	🔧 1	📄 000960946
96T/S6 2-2,5-3-4-5-6 mm	€ 84,50	🔧 1	📄 000960952
96T/S8 2-2,5-3-4-5-6-8-10 mm	€ 130,00	🔧 1	📄 000960933
96T/S11 2-2,5-3-3,5-4-4,5-5-6-7-8-10 mm	€ 177,00	🔧 1	📄 000960951



96T/SP11 2-2,5-3-3,5-4-4,5-5-6-7-8-10 mm	€ 220,00	🔧 1	📄 000960957
96T/SPV 96T/S11 97TTX/S11	€ 49,00	🔧 1	📄 000960958

## 96T/AS

chaves macho hexagonal com punho

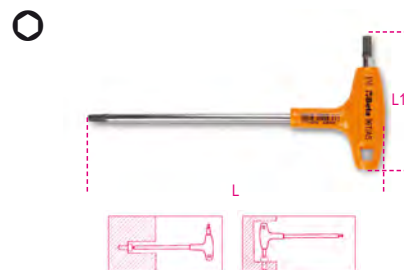

"	L mm	L1 mm	€	🔧	📄
3/32	153	55	16,20	2	000960669
7/64	153	55	16,20	2	000960670
1/8	179	70	16,40	2	000960671
9/64	179	70	17,20	2	000960672
5/32	200	84	17,20	2	000960673
3/16	200	84	17,20	2	000960674
7/32	221	103	19,10	2	000960675
1/4	236	106	21,30	2	000960676
5/16	255	117	24,20	2	000960678
3/8	285	132	29,00	2	000960680



96T/AS8 3/32-7/64-1/8-5/32-3/16-1/4-5/16-3/8	€ 157,00	🔧 1	📄 000960682
96T/AS10 3/32-7/64-1/8-9/64-5/32-3/16-7/32-1/4-5/16-3/8	€ 194,00	🔧 1	📄 000960683

## 96TBP

chaves macho hexagonal com punho e extremidade esférica



mm	L mm	L1 mm	€	🔧	📄
2,5	153	55	13,70	3	000960685
3	153	55	14,30	3	000960686
4	179	70	15,10	3	000960687
5	200	84	15,70	3	000960688
6	221	103	17,20	3	000960689
8	255	117	22,70	2	000960690
10	285	132	24,20	2	000960692



96TBP/S6	€ 99,00	🔧 1	📄 000960694
----------	---------	-----	-------------

2,5-3-4-5-6-8 mm

## 97TX

chaves macho para parafusos com cabeça Torx®



⌀	L mm	L1 mm	€	🔧	📄
T6	42	16	7,30	5	000970006
T7	48	16	7,30	5	000970007
T8	48	16	7,30	5	000970008
T9	48	16	8,00	5	000970009
T10	51	17	8,20	5	000970010
T15	54	18	8,20	5	000970015
T20	57	19	8,70	5	000970020
T25	60	20	8,90	5	000970025
T27	64	21	9,80	5	000970027
T30	70	24	9,80	5	000970030
T40	76	26	10,90	5	000970040
T45	83	29	13,00	5	000970045
T50	95	32	14,90	5	000970050
T55	108	35	18,90	5	000970055
T60	120	38	25,00	5	000970060



97TX/ST8	€ 78,00	🔧 1	📄 000970640
----------	---------	-----	-------------

T9-T10-T15-T20-T25-T27-T30-T40



97TX/G8	€ 61,50	🔧 1	📄 000970645
---------	---------	-----	-------------

T9-T10-T15-T20-T25-T27-T30-T40



97TX/BG8	€ 48,50	🔧 1	📄 000970368
----------	---------	-----	-------------

T9-T10-T15-T20-T25-T27-T30-T40



97TX/SC8	€ 77,00	🔧 1	📄 000970064
----------	---------	-----	-------------

T9-T10-T15-T20-T25-T27-T30-T40



97TX/B13	€ 124,00	🔧 1	📄 000970650
----------	----------	-----	-------------

T6-T7-T8-T9-T10-T15-T20-T25-T27-T30-T40-T45-T50

## 97BTX

chaves macho com uma extremidade esférica, para parafusos com cabeça Torx®

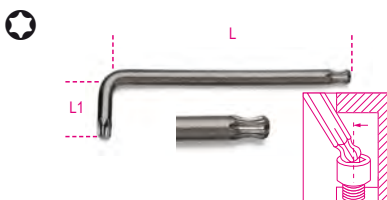

⌀	L mm	L1 mm	€	🔧	📄
T9	62	16	9,30	5	000970109
T10	71	17	9,30	5	000970110
T15	81	18	9,30	5	000970115
T20	92	19	10,00	5	000970120
T25	94	20	10,60	5	000970125
T27	105	21	11,30	5	000970127
T30	114	24	11,40	5	000970130
T40	129	26	13,10	5	000970140
T45	133	28	15,40	5	000970145



97BTX/SC8	€ 89,00	🔧 1	📄 000970164
-----------	---------	-----	-------------

T9-T10-T15-T20-T25-T27-T30-T40



97BTX/B8	€ 86,50	🔧 1	📄 000970159
----------	---------	-----	-------------

T9-T10-T15-T20-T25-T27-T30-T40



97BTX-C/SC8	€ 98,50	🔧 1	📄 000971658
-------------	---------	-----	-------------

T9-T10-T15-T20-T25-T27-T30-T40

## 97BTXL

chaves macho com uma extremidade esférica, para parafusos com cabeça Torx®, modelo longo



⌀	L mm	L1 mm	€	🔧	📄
T9	80	15	9,80	3	000970309
T10	86	17	9,80	3	000970310
T15	100	18	9,80	3	000970315
T20	110	19	11,20	3	000970320
T25	126	20	12,30	3	000970325
T27	140	24	13,80	3	000970327
T30	160	28	14,30	3	000970330
T40	176	32	17,10	3	000970340



97BTXL/SC8	€ 103,00	🔧 1	📄 000970364
------------	----------	-----	-------------

T9-T10-T15-T20-T25-T27-T30-T40

## 97RTX

chaves macho para parafusos com cabeça Tamper Resistant Torx®



Ø	L mm	L1 mm	€	U	PC
T6	40	15	8,80	5	000970206
T7	45	15	8,80	5	000970207
T8	50	16	8,80	5	000970208
T9	56	16	8,80	5	000970209
T10	62	17	8,80	5	000970210
T15	72	17	8,80	5	000970215
T20	83	18	9,00	5	000970220
T25	90	18	9,30	5	000970225
T27	100	20	10,50	5	000970227
T30	105	24	10,60	5	000970230
T40	112	26	11,60	5	000970240
T45	118	26	13,70	5	000970245
T50	122	28	17,60	3	000970250
T55	128	30	20,20	3	000970255



97RTX/SC8 T9-T10-T15-T20-T25 T27-T30-T40	€ 82,00	U 1	PC 000970263
97RTX/SCV	4,85	U 1	PC 000970984



97RTX/B8 T9-T10-T15-T20-T25 T27-T30-T40	€ 79,50	U 1	PC 000970260
96N/BV	2,17	U 1	PC 000960651

## 97BRTLX/SC8

jogo de 8 chaves sextavadas macho com ponta de bola, modelo longo, para parafusos de perfil Tamper Resistant Torx®



97BRTLX/SC8 T9-T10-T15-T20-T25-T27-T30-T40	€ 104,00	U 1	PC 000970464
97BRTLX/SCV	4,85	U 1	PC 000970986

## 97TTX

chaves duplas macho com punho para parafusos com cabeça Torx®



Ø	L mm	L1 mm	€	U	PC
T6	130	52	13,50	3	000970706
T7	130	52	13,50	3	000970707
T8	139	52	13,60	3	000970708
T9	139	52	13,60	3	000970709
T10	179	70	13,90	3	000970710
T15	179	70	15,00	3	000970715
T20	179	70	15,50	3	000970720
T25	179	70	16,50	3	000970725
T27	200	84	18,10	3	000970727
T30	200	84	18,80	3	000970730
T40	221	103	22,30	3	000970740
T45	236	106	26,00	2	000970745
T50	255	117	33,50	2	000970750



97TTX/S6 T10-T15-T20-T25-T30-T40	€ 102,00	U 1	PC 000970791
97TTX/S8 T8-T10-T15-T20-T25-T27-T30-T40	134,00	U 1	PC 000970808
97TTX/S11 T8-T9-T10-T15-T20-T25-T27-T30-T40-T45-T50	207,00	U 1	PC 000970800
97TTX/S13 T6-T7-T8-T9-T10-T15-T20-T25-T27-T30-T40-T45-T50	233,00	U 1	PC 000970813



97TTX/SP11 T8-T9-T10-T15-T20-T25-T27-T30-T40-T45-T50	€ 250,00	U 1	PC 000970840
96T/SPV 96T/S11 97TTX/S11	49,00	U 1	PC 000960958

## 98XZN

chaves macho hexagonal com perfil XZN®



DIN 65253

Ø	L mm	L1 mm	€	U	PC
M5	83	25	6,30	5	000980005
M6	89	30	7,20	5	000980006
M8	97	32	9,20	5	000980008
M10	106	35	12,00	5	000980010
M12	116	37	15,20	5	000980012



98XZN/B5 M5-M6-M8-M10-M12	€ 52,00	U 1	PC 000980650
96N/BV	2,17	U 1	PC 000960651

## 99

chaves de unha quadrada para porcas com encaixes laterais UNI/ISO 2982, 2983



UNI 6752

Ø mm	A mm	€	U	PC
12-14	1,5	12,10	3	000990012
16-18-20	1,8	12,10	3	000990016
22-25-28	1,8	16,20	3	000990022
30-32	2,1	16,20	3	000990030
34-36-38	2,4	19,70	3	000990034
40-42	2,4	19,70	3	000990040
45-50	2,5	24,40	3	000990045
52-55-58	2,5	24,40	3	000990052
62-65	3,1	30,50	3	000990062
68-70-75	3,1	30,50	3	000990068
80-85-90	3,8	41,00	2	000990080
92-95	4,3	41,00	2	000990092
98-100	4,3	41,00	2	000990098
105-110-115	4,4	65,00	1	000990105
120-125-130	4,9	65,00	1	000990120
135-145	6,0	95,50	1	000990135
155-165	6,0	95,50	1	000990155

## 99SQ

chaves de unha quadrada articulada para porcas com encaixes laterais



Ø mm	S mm	€	U	PC
15-35	5,1	32,50	2	000990215
35-50	6,0	37,00	2	000990235
50-80	8,0	48,50	2	000990250
80-120	8,3	66,50	2	000990280
120-180	10,8	89,00	2	000990290



## 99ST

chaves de unha articulada com pino redondo amovível



mm	Ø mm	B mm	€	W	U
15-35	3,0	2,5	33,50	2	000990315
35-50	4,0	4,5	39,50	2	000990335
50-80	5,0	5,0	52,50	2	000990350
80-120	6,0	7,0	71,50	2	000990380
120-180	8,0	9,0	93,00	2	000990390

## 99 VN/...

ponta de substituição para artigo 99ST

99ST VN/	mm	€	W	U
15-35	15-35	9,20	1	000990295
35-50	35-50	10,60	1	000990296
50-80	50-80	13,00	1	000990297
80-120	80-120	15,00	1	000990298
120-180	120-180	19,70	1	000990299

## 100

chaves de compasso com unhas redondas para porcas com furos de manobra frontais



Ø mm	L mm	Ø mm	€	W	U
4,8-5,8	250	18÷100	171,00	1	001000001
6,9-7,9					

## 100/KIT

unhas de substituição para refª. 100



100/KIT	€	W	U
	52,50	1	001000010



## 111E CHAVES DE ABERTURA VARIÁVEL COM ESCALA

As novas chaves de abertura variável com escala, Beta 111E, permitem apertar e desapertar porcas e parafusos de diferentes tamanhos através dos mordentes deslizantes, que podem ser ajustados através dos rolos centrais. Cabeça inclinada a 15°, permitindo alcançar espaços de difícil acesso, como é o caso das nossas icónicas chaves mistas boca/luneta, "42"



Abertura grande

Cabeça compacta com o mordente completamente aberto

Marcação a laser dupla em mm/polegadas



Com base nas novas propriedades ergonómicas, o peso foi reduzido em 20%.

Em liga de aço de alto desempenho para maior resistência mecânica à torção.

Tratamento térmico especial para excelente resistência ao desgaste  
Furo no punho para pendurar a chave

## 111E

chaves ajustáveis com escala, cromadas

- Rotação do pino à direita
- Escala mm/polegadas



DIN 3117 ISO 6787

L mm	L "	A max mm	€	W	U
100	4	15	26,00	3	001110110
150	6	24	27,00	3	001110115
200	8	29	33,00	3	001110120
250	10	34	40,00	3	001110125
300	12	40	53,00	3	001110130
380	15	45	104,00	3	001110138
450	18	54	173,00	2	001110145
600	24	62	240,00	1	001110160



111E/D3	€	W	U
150-200-250 mm	100,00	1	001110163

## 111EN

chaves ajustáveis com escalas, fosfatadas

- Rotação do pino à esquerda
- Escala mm/polegadas



DIN 3117 ISO 6787

L mm	L "	A max mm	€	W	U
100	4	15	23,80	3	001110410
150	6	24	24,90	3	001110415
200	8	29	29,00	3	001110420
250	10	34	36,00	3	001110425
300	12	40	48,50	3	001110430
380	15	45	96,00	3	001110438
450	18	54	164,00	2	001110445

## 111ER

chaves ajustáveis de mordente reversível, com escalas, cromadas

- Mordente reversível
- Rotação do pino à direita
- Escala mm/polegadas



L mm	L "	A max mm	Ø max mm	€	W	U
200	8	29	3/4	34,50	3	001110520
250	10	34	1	42,50	3	001110525
300	12	40	1.1/4	55,50	2	001110530

## 111CM

chaves ajustáveis de grande abertura, cromadas, série curta

- Grande abertura
- Rotação à direita
- Escala mm/polegadas



L mm	L"	A max mm	€	🔧	📄
170	6	32	39,50	2	001110770
220	8	38	48,00	3	001110722
270	10	46	63,50	3	001110727

## 120

chaves de luneta aberta de 12 faces com sistema de roquete simples



Ø mm	L mm	€	🔧	📄
10	135	54,00	1	001200010
11	135	54,00	1	001200011
12	135	54,00	1	001200012
13	135	54,00	1	001200013
14	135	61,50	1	001200014
17	185	66,00	1	001200017
19	185	70,50	1	001200019
22	230	95,50	1	001200022
24	230	103,00	1	001200024
27	230	131,00	1	001200027
30	320	148,00	1	001200030
32	320	157,00	1	001200032



120/B6N 10-11-13 17-19-22 mm	407,00	1	001200060
2002/BVL6	12,70	1	020020010

# Beta

## 123E1/4

adaptador, 1/4", para chaves de roquete de 10 mm

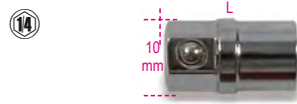

Ø mm	L mm	€	🔧	📄
10	20,6	7,10	1	001230010

## 123Q1/4

adaptador de desengate rápido, 1/4", para chaves de roquete, 10mm



Ø mm	L mm	€	🔧	📄
10	17,5	9,90	1	001230310

## 123Q3/8

adaptador de desengate rápido, 3/8", para chaves de roquete, 13mm



Ø mm	L mm	€	🔧	📄
13	22,5	10,00	1	001230313

## 123Q1/2

adaptador de desengate rápido, 1/2", para chaves de roquete, 19mm



Ø mm	L mm	€	🔧	📄
19	30,5	10,60	1	001230319

# Beta

## 123/K4

kit com 4 adaptadores para chaves de roquete:

- 1 ponta adaptadora
- 3 adaptadores de desengate rápido



123/K4	37,50	1	001230504
--------	-------	---	-----------

## 141

chaves boca/luneta com sistema de roquete, série reta



ISO 21982:2020

Ø mm	L mm	€	🔧	📄
8x8	136	17,80	3	001410008
9x9	143	18,60	3	001410009
10x10	160	19,10	3	001410010
11x11	168	19,50	3	001410011
12x12	174	20,20	3	001410012
13x13	180	22,00	3	001410013
14x14	193	22,90	2	001410014
15x15	200	23,90	2	001410015
16x16	216	26,00	2	001410016
17x17	233	27,00	2	001410017
18x18	239	28,50	2	001410018
19x19	250	29,00	2	001410019



141/B6 8-10-13-14-17-19 mm	148,00	1	001410066
141/B9 8-10-11-12-13-14-15-17-19 mm	214,00	1	001410069



141/S12 8-9-10-11-12-13- 14-15-16-17-18-19 mm	274,00	1	001410072
---	--------	---	-----------

# Beta



# 142 CHAVES DE ROQUETE

O roquete de ação rápida com 72 dentes proporciona um ângulo de penetração não superior a 5°, resultando num aperto rápido e preciso.

❶ A boca fixa possibilita um aperto forte, com base no veio longo.

❷ A alavanca de inversão integrada evita o risco de inversão accidental.



❸ A extremidade de luneta bi-sextavada tem um ângulo de 15°, para proteção da mão e fácil acesso.

❹ A cabeça fixa tem um ângulo de 15° em relação ao eixo, obtendo-se assim um ângulo de penetração reduzido.



Modelo	€	Quantidade	Artigo
142/B6 8-10-13-14-17-19 mm	169,00	1	001420066
142/BV6	9,90	1	001420076
142/B9 8-10-11-12-13-14-15-17-19 mm	245,00	1	001420069
142/BV9	11,80	1	001420079



Modelo	€	Quantidade	Artigo
142/S15 6-7-8-9-10-11-12-13 14-15-16-17-18-19-22 mm	402,00	1	001420074
142/S17 6-7-8-10-11-12-13-14-15- 16-17-18-19-21-22-24-27 mm	555,00	1	001420068
142/S19 6-7-8-9-10-11-12 13-14-15-16-17-18 19-22-24-27-30-32 mm	715,00	1	001420075

## 142/SC9I-E

jogo de 9 chaves mistas boca luneta, com sistema de roquete, suporte compacto



Modelo	€	Quantidade	Artigo
142/SC9I 8-10-11-12-13-14-15-17-19 mm	242,00	1	001420087
142/SCV9I	10,90	1	001420103
142/SC9E 8-10-11-12-13-16-17-18-19 mm	252,00	1	001420088
142/SCV9E	10,90	1	001420104

## 142MC

chaves mistas boca/luneta, com sistema de roquete reservável, coloridas



ISO 21982:2020

mm	L mm	€	Quantidade	Artigo
8x8	136	21,20	3	001422008
10x10	159	23,20	3	001422010
11x11	168	23,70	3	001422011
12x12	174	24,80	3	001422012
13x13	180	26,50	3	001422013
14x14	190	28,00	2	001422014
15x15	200	29,00	2	001422015
16x16	216	32,00	2	001422016
17x17	233	32,50	2	001422017
18x18	239	34,50	2	001422018
19x19	248	35,50	2	001422019



Modelo	€	Quantidade	Artigo
142MC/SC9I 8-10-11-12-13-14-15-17-19 mm	254,00	1	001422087
142MC/SC9E 8-10-11-12-13-16-17-18-19 mm	264,00	1	001422088

## 142AS

chaves boca/luneta com sistema de roquete



mm	L mm	€	Quantidade	Artigo
5/16x5/16	136	23,70	2	001420308
3/8x3/8	159	24,20	2	001420310
7/16x7/16	168	25,50	2	001420311
1/2x1/2	180	29,00	2	001420313
9/16x9/16	190	29,50	2	001420314
5/8x5/8	216	32,50	2	001420316
11/16x11/16	233	33,50	2	001420317
3/4x3/4	248	36,50	2	001420319



Modelo	€	Quantidade	Artigo
142AS/8 5/16-3/8-7/16-1/2 9/16-5/8-11/16-3/4	235,00	1	001420330

## 142

chaves boca/luneta com sistema de roquete



ISO 21982:2020

mm	L mm	€	Quantidade	Artigo
6x6	136	19,50	3	001420006
7x7	136	19,50	3	001420007
8x8	136	20,10	3	001420008
9x9	143	21,50	3	001420009
10x10	159	22,10	3	001420010
11x11	168	22,80	3	001420011
12x12	174	23,60	3	001420012
13x13	180	25,50	3	001420013
14x14	190	26,00	2	001420014
15x15	200	28,00	2	001420015
16x16	216	30,00	2	001420016
17x17	233	31,00	2	001420017
18x18	239	33,50	2	001420018
19x19	248	34,00	2	001420019
21x21	285	43,50	1	001420021
22x22	285	45,50	1	001420022
24x24	325	52,50	1	001420024
27x27	355	76,00	1	001420027
30x30	420	89,00	1	001420030
32x32	420	92,50	1	001420032
34x34	482	129,00	1	001420034
36x36	482	130,00	1	001420036
38x38	482	133,00	1	001420038





## 142C

chaves boca/luneta, série curta



ISO 21982:2020

Ø mm	L mm	€	U	PC
8x8	88	14,50	2	001420108
9x9	96	14,50	2	001420109
10x10	96	15,10	2	001420110
11x11	100	16,10	2	001420111
12x12	104	17,10	2	001420112
13x13	108	17,80	2	001420113
14x14	114	18,60	2	001420114
15x15	118	19,20	2	001420115
16x16	122	19,80	2	001420116
17x17	128	21,50	2	001420117
18x18	132	23,20	2	001420118
19x19	138	23,70	2	001420119



<b>142C/A12</b>	€ 250,00	U 1	PC 001420175
8-9-10-11-12-13-14 15-16-17-18-19 mm			

## 142SN

chaves boca/luneta articulada com sistema de roquete



ISO 21982:2020

Ø mm	L mm	€	U	PC
7x7	136	23,40	2	001420207
8x8	136	24,20	2	001420208
9x9	143	25,50	2	001420209
10x10	160	26,50	2	001420210
11x11	168	28,00	2	001420211
12x12	174	29,00	2	001420212
13x13	180	31,00	2	001420213
14x14	193	32,00	2	001420214
15x15	200	34,00	2	001420215
16x16	216	36,00	2	001420216
17x17	233	36,50	2	001420217
18x18	239	39,50	2	001420218
19x19	250	40,00	2	001420219
22x22	285	47,50	1	001420222
24x24	325	53,00	1	001420224



<b>142SN/S13</b>	€ 405,00	U 1	PC 001420263
7-8-9-10-11-12-13-14 15-16-17-18-19 mm			



<b>142SN/SC9</b>	€ 290,00	U 1	PC 001420259
8-10-11-12-13-14-15-17-19 mm			

## 186

chave auto-ajustável, 8 a 32 mm

Ideal para parafusos de cabeça sextavada, quadrada, Spline e Torx®, mesmo danificados.

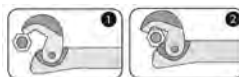
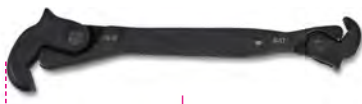

L mm	€	U	PC
260	55,50	1	001860008



# Beta



## 187

chave de luneta articulada

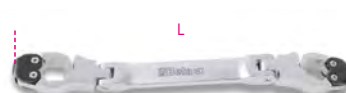

Ø mm	L mm	€	U	PC
8x9	125	37,50	1	001870008
10x11	155	40,50	1	001870010
12x13	175	41,50	1	001870012
14x15	205	46,00	1	001870014
16x17	235	52,00	1	001870016



<b>187/B5</b>	€ 229,00	U 1	PC 001870050
8x9-10x11-12x13 14x15-16x17 mm			

## 192

chaves bi-hexagonais com sistema de roquete reversível, cromadas, 4 in 1



Ø mm	L mm	€	U	PC
8x10/12x13	160	32,00	1	001920008
16x17/18x19	230	41,00	1	001920016

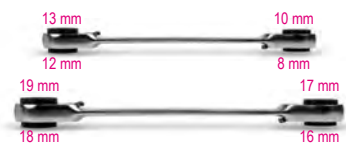

<b>192/S2</b>	€ 73,50	U 1	PC 001920070
8x10/12x13 mm 16x17/18x19 mm			

## 194

chave de caixa com sistema de roquete reversível



Ø	L mm	€	U	PC
1/4x5/16	128	41,00	2	001940006

## 195

chave de luneta dupla, bi-hexagonal, com sistema de roquete



ISO 21982:2020

Ø mm	L mm	€	U	L
8x10	128	22,40	2	001950010
12x13	170	25,50	2	001950013
14x15	190	27,00	2	001950015
16x18	230	31,50	2	001950018
17x19	230	33,50	2	001950019



195/B5	€	U	L
8x10-12x13-14x15 16x18-17x19 mm	152,00	1	001950066
195/BV5	11,80	1	001950070

## 195AS

chave de luneta dupla cromada, bisextavada, com sistema de roquete



Ø mm	L mm	€	U	L
5/16x3/8	128	23,20	2	001950606
7/16x1/2	170	25,50	2	001950611
9/16x5/8	190	29,00	2	001950614
11/16x3/4	230	32,50	2	001950617



195AS/B4	€	U	L
5/16x3/8 - 7/16x1/2 - 9/16x5/8 - 11/16x3/4	123,00	1	001950654
195FTX/BV4	11,80	1	001950520



## 195P

chave bi-hexagonal dupla inclinada a 15° e com sistema de roquete reversível



ISO 21982:2020

Ø mm	L mm	€	U	L
8x10	128	34,00	2	001950210
12x13	170	36,00	2	001950213
14x15	190	37,00	2	001950215
16x18	230	41,50	2	001950218
17x19	230	43,50	2	001950219



195P/B5	€	U	L
8x10-12x13-14x15 16x18-17x19 mm	204,00	1	001950266
195/BV5	11,80	1	001950070

## 310

ferro de soldar tubos e uniões de pequenas dimensões em plástico tipo PE, PP, PVC e PEHD

CE



230V-650 Watt  
50 Hz±60Hz

Schuko (CEE 7/7)

310/2	Ø mm	€	U	L
	16÷63	416,00	1	003100002

## 310B

matrizes para o polifusor modelo 310



Ø mm	€	U	L
16	71,00	1	003100016
20	78,00	1	003100020
25	83,50	1	003100025
32	92,50	1	003100032
40	109,00	1	003100040
50	138,00	1	003100050
63	159,00	1	003100063

## 310/C8

jogo com polifusor e 7 matrizes



310/C8	€	U	L
310/2+310B: Ø 16-20-25 32-40-50-63	935,00	1	003100108
☞ 440x270x120 mm - 7,7 kg			

## 311

ferro de soldar tubos e uniões de grandes dimensões em plástico tipo PE

CE



230V  
50 Hz±60Hz

Schuko (CEE 7/7)

	Ø mm	Watt	€	U	L
311/1	120	300	371,00	1	003110001
311/2	190	900	412,00	1	003110002



# Beta

# Beta

# CAMPOS DE APLICAÇÃO DOS CORTA-TUBOS

Os corta-tubos Beta cobrem uma ampla gama de aplicações. Os seus rolos suaves, o parafuso ou alimentador telescópico possibilitam cortes limpos e precisos em todos os materiais utilizados na construção de tubagens.

O quadro abaixo indica as combinações de corta-tubos/discos de corte para cada material.

	TUBOS DE GÁS EM AÇO			TUBOS DE GÁS EM AÇO INOX		
	10 mm	60 mm	115 mm	10 mm	60 mm	115 mm
	1/8"	2"	4"	1/8"	2"	4"
330/2				330/2+330R/I2		
330/4				330/4+330R/I4		

	TUBOS DE LIGA LEVE E COBRE							
	3 mm	6 mm	8 mm	16 mm	28 mm	30 mm	38 mm	67 mm
	1/8"	1/4"	5/16"	5/8"	1"1/8"	1"1/2"	2"5/8"	
332								
334								
336								
338								

	TUBOS EM AÇO INOX FINOS							
	3 mm	6 mm	8 mm	16 mm	28 mm	30 mm	38 mm	67 mm
	1/8"	1/4"	5/16"	5/8"	1"1/8"	1"1/2"	2"5/8"	
332 + 334R/I								
334 + 334R/I								
336 + 338R/I								
338 + 338R/I								

	TUBOS EM PLÁSTICO							
	6 mm	8 mm	16 mm	30 mm	38 mm	50 mm	67 mm	127 mm
	1/4"	5/16"	5/8"	1"1/8"	1"1/2"	2"	2"5/8"	5"
336 + 338RP								
338 + 338RP								

## 330

corta-tubos para tubos de gás em aço



	Ø mm - "	L mm	€		
330/2	10÷60 1/8"÷2"	380	177,00	1	003300002
330/4	60÷115 2"÷4"	585	402,00	1	003300004

## 330R/A

cortante de substituição para o modelo 330 para tubos em aço



	Ø mm	S mm	€		
330R/A2	32	7	17,00	1	003300012
330R/A4	42	9	44,00	1	003300014

## 330R/I

cortante de substituição para o artigo 330 para tubos de aço inox



	Ø mm	S mm	€		
330R/I2	32	7	38,00	1	003300024
330R/I4	32	9	107,00	1	003300034

## 331C

corta-tubos portátil em C para cobre e ligas leves



	Ø mm	L mm	€		
15÷22	15÷22	78	63,00	1	003310050

## 332

mini corta-tubos para cobre e ligas leves



	Ø mm - "	L mm	€		
3÷16	3÷16	59	25,50	2	003320001
1/8"÷5/8"	1/8"÷5/8"	63	28,50	2	003320003

## 334

corta-tubos para cobre e ligas leves



	Ø mm - "	L mm	€		
3÷30	3÷30	150	35,00	1	003340001
1/8"÷1"1/8"	1/8"÷1"1/8"				

## 334R

cortante de substituição para os modelos com ref. 332 e 334 para cobre e ligas leves

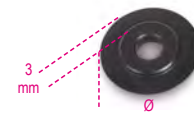

	D mm	€		
334R	18	7,50	1	003340021

## 334R/I

cortante de substituição para os modelos com ref. 332 e 334 para aço inox



	D mm	€		
334R/I	18	21,40	1	003340023





### 336

corta-tubos com avanço telescópico para cobre e ligas leves



Ø mm -"	L mm	€	1	003360001
6÷38 1/4"÷1"1/2	160	58,00	1	003360001

### 338

corta-tubos com avanço telescópico rápido para cobre, ligas leves e plásticos



Ø mm -"	L mm	€	1	003380001
6÷67 1/4"÷2"5/8	290	145,00	1	003380001

### 338R

cortante de substituição para os modelos 331L, 336 e 338 para cobre e ligas leves



Ø mm	€	1	003380022
338R 18,5	8,00	1	003380022

### 338R/I

cortante de substituição para os modelos 336 e 338 para aço inox

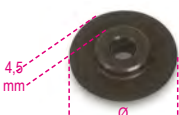

Ø mm	€	1	003380023
338R/I 21,8	23,70	1	003380023

### 338RP

cortante de substituição para os modelos 336 e 338 para plástico



Ø mm	€	1	003380025
338RP 21,9	8,70	1	003380025

### 340

alicate para corte de tubos multi-camadas max. Ø 26 mm

- Lâmina com revestimento PTFE
- 4 rolos de suporte para facilitar a rotação do tubo durante o trabalho
- Punho com sistema integrado para corte de tubos ondulados
- Corpo leve em magnésio
- Ø máx.: 26 mm



Ø max mm	€	1	003400001
340 26	120,00	1	003400001

### 340RL

Lamina de substituição para o item 340



340RL	€	1	003400010
	34,00	1	003400010

### 340C

alicate corta-tubos para tubos corrugados

- alicates em liga de alumínio e magnésio
- compactos, tamanho de bolso, leves
- lâmina adicional para corte longitudinal



Ø mm	L mm	€	1	003400050
340C 14-45	134	57,00	1	003400050

### 340C/KRL

kit de 3 lâminas de substituição para 340C



340C/KRL	€	1	003400055
	34,00	1	003400055

### 341

alicate corta-tubos para tubos plásticos



Ø mm	L mm	€	1	003410001
341 0÷25	190	43,00	1	003410001

### 341RL

lâmina de substituição para o modelo 341



341RL	€	1	003410010
	19,30	1	003410010

### 341B

tesoura com roquete para tubos de plástico



Ø mm	L mm	€	1	003410051
341B 0÷35	195	79,00	1	003410051

### 341B/RM

mola de substituição para o artigo 341B

341B/RM	€	1	003410061
	2,95	1	003410061

### 341B/RL

lâminas de substituição para o artigo 341B

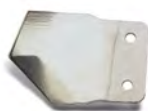

341B/RL € 29,50 1 003410060

### 342

Tesoura com roquete para tubos de plástico



∅ mm - " 0÷42 1"5/8 L mm 200 € 57,50 1 003420030

### 342MOL

mola de substituição para o artigo 342

342MOL € 4,20 1 003420033

### 342RL

lâmina de substituição para o artigo 342



342RL € 26,50 1 003420032

### 342A

tesoura com roquete para tubos plásticos



∅ mm - " 0÷50 2" L mm 270 € 118,00 1 003420101

### 342A/MOL

mola de substituição para artigo 342A

342A/MOL € 2,54 1 003420111

### 342A/RL

lâmina de substituição para o modelo 342A



342A/RL € 61,50 1 003420110

### 342P

tesoura com roquete para tubos plásticos, corpo em liga de magnésio



∅ mm - " 0÷50 2" L mm 260 € 128,00 1 003420121

### 342P/RL

lâmina de substituição para ref. 342P



342P/RL € 53,50 1 003420130

### 345

ferramenta rebarba-tubos corpo em metal



∅ mm - " 3÷42 1/8"÷1"5/8 L mm 58 € 31,00 5 003450001

### 345U

ferramenta rebarba-tubos para aço inoxidável, aço, cobre e ligas leves



∅ mm - " 4÷36 5/32÷1"7/16 L mm 60 € 82,00 1 003450050

### 345U/A

adaptador para ferramenta rebarba-tubos 345U, para pontas encabadouro sextavado 1/4"



1/4" L mm 90 € 20,80 3 003450055

### 345C

manómetro para tubos com várias camadas



∅ mm 16-20-26-32 € 49,00 1 003450032

### 345SB

rebarbador de lâmina giratório com lâmina intermutável



L mm 150 € 25,50 5 003450010

### 345SB/R

lâmina de substituição para o modelo 345SB



345SB/R € 9,00 3 003450015

### 345SB2

raspador com lâmina fixa



L mm 140 € 12,80 5 003450022

### 345SC

escova 4 em 1 para diâmetros interiores e exteriores, 1/2" e 3/4"



L mm	L1 mm	L2 mm	€	🔧	📦
195	28	32	14,90	2	003450060

### 345SI

raspador para uso interno, com lâmina rotativa de substituição



L mm	∅ mm	€	🔧	📦
168	16,5	48,50	1	003450040

### 345SI/R

lâmina de substituição para artigo 345SI



345SI/R	€	🔧	📦
	33,50	1	003450045

### 349

abocardador com embraiagem para tubos em cobre e ligas leves

3/8"



∅ mm - "	€	🔧	📦
6-8-10-12-14-15-16-18 (1/8-3/16-1/4-5/16 3/8-1/2-5/8-3/4)	307,00	1	003490001

270x200x50 mm - 2,7 kg

### 349/SMM

fixador de tubos métrico para artigo 349



∅ mm	€	🔧	📦
6-8-10-12-14-15-16-18	90,00	1	003490011

### 349/SMAS

fixador de tubos em polegadas para artigo 349



∅	€	🔧	📦
1/8-3/16-1/4-5/16 3/8-1/2-5/8-3/4	85,00	1	003490012

### 350

abocardador, para tubos em cobre e ligas leves



∅ mm	L mm	A mm	€	🔧	📦
4-4,75-6-8 10-12-14	175	104	89,00	1	003500001

### 351C

corta-tubos e abocardador



351C	€	🔧	📦
	161,00	1	003510010

334	∅ 3+30 mm (1/8"+1"1/8)
350	∅ 4+14 mm
351P	∅ 4-4,75-6-8-10-12-14 mm
225x150x45 mm - 1,6 kg	

### 351P

punções para abocardador ref. 350



351P	∅ mm	€	🔧	📦
4	4	7,40	3	003510101
4,75	4,75	7,40	3	003510102
6	6	7,40	3	003510103
8	8	7,40	3	003510104
10	10	7,40	3	003510105
12	12	7,40	3	003510106
14	14	7,40	3	003510107

### 352U

abocardador regulável para cobre e ligas leves

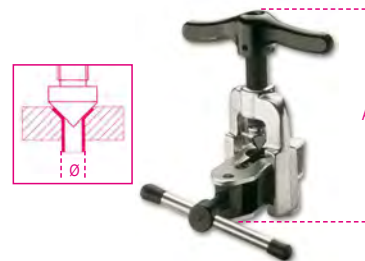

∅ mm - "	A mm	€	🔧	📦
5-16 3/16-5/8	130	106,00	1	003520101

### 352C/U

jogo corta-tubos, rebarbador e abocardador, artigos 334, 345SB e 352U



352C/U	€	🔧	📦
	208,00	1	003520110

334	∅ 3+30 mm (1/8"+1"1/8)
345SB	
352U	∅ 5+16 mm (3/16"+5/8")
335x145x60 mm - 2120 g	

### 355

chave de 5 graduações para radiadores

1/2"



∅	L mm	€	🔧	📦
3/8"-1/2" 3/4"-1"	90	42,00	2	003550001

### 357F3

nível com 3 bolhas

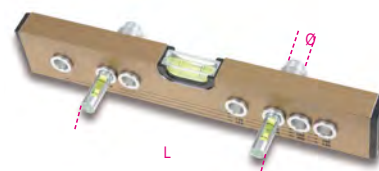

∅	L mm	€	🔧	📦
3/8" / 1/2"	90=220	133,00	1	003570100



### 357R/F3

bolha de substituição para nível 357F3



357R/F3	€ 21,50	1	003570101
---------	---------	---	-----------

### 358

aparelhos para chanfrar externamente tubos plásticos



	Ø mm	€		
358/1	16÷110	188,00	1	003580001
358/2	40÷250	188,00	1	003580002

### 358RL

lâmina de substituição com batente para os modelos 358/1 e 358/2



358RL	€ 34,50	1	003580011
-------	---------	---	-----------

### 359

chave universal para bujões



Ø"	L mm	A mm	€	
1"÷1"1/4	160	140	92,50	1 003590001

### 359CH

adaptador para bujões em cruz para o modelo 359



Ø"	L mm	€		
1"1/2	74	52,50	1	003590005

### 360

chaves para tubos modelo Stillson



L mm	Ø max"	Ø max mm	€		
250	1" gas	34	38,50	1	003600025
350	1"1/2 gas	49	51,00	1	003600035
450	2" gas	60	71,00	1	003600045
600	2"1/2 gas	76	109,00	1	003600060
900	3"1/2 gas	102	301,00	1	003600090

### 360R/...

kit peças de substituição para ref. 360 com mordente móvel e porca.

	€		
360R 250	14,30	1	003600225
360R 350	19,70	1	003600235
360R 450	28,50	1	003600245
360R 600	42,00	1	003600260
360R 900	75,00	1	003600290

### 361N

chave de tubos de alavanca ajustável



L mm	Ø max"	Ø max mm	€		
350	1" 1/2	49	79,50	1	003610014

### 362

chaves para tubos modelo americano



L mm	Ø max"	Ø max mm	€		
200	1" gas	34	33,50	1	003620020
250	1"1/2 gas	49	42,50	1	003620025
300	2" gas	60	51,00	1	003620030
350	2" gas	60	61,00	1	003620035
450	2"1/2 gas	76	87,50	1	003620045
600	3" gas	90	133,00	1	003620060
900	5" gas	140	163,00	1	003620090

### 362R/...

kit peças de substituição para ref. 362 com: mordente fixa, mordente móvel; porca; pino de segurança.

	€		
362R 200	7,10	1	003620220
362R 225	10,10	1	003620225
362R 300	12,50	1	003620230
362R 350	14,30	1	003620235
362R 450	19,60	1	003620245
362R 600	26,50	1	003620260
362R 900	65,50	1	003620290

### 363

chaves para tubos modelo americano em ligas leves



L mm	Ø max"	Ø max mm	€		
350	2" gas	60	73,00	1	003630035
450	2"1/2 gas	76	98,50	1	003630045
600	3" gas	90	166,00	1	003630060
900	5" gas	140	312,00	1	003630090
1200	6" gas	165	330,00	1	003630120

### 363R/...

kit peças de substituição para ref. 363 com: mordente fixa, mordente móvel; porca; pino de segurança.

	€		
363R 350	15,80	1	003630235
363R 450	20,90	1	003630245
363R 600	29,00	1	003630260
363R 900	57,00	1	003630290
363R 1200	88,00	1	003630320



### 365

chaves para tubos modelo frontal em ligas leves

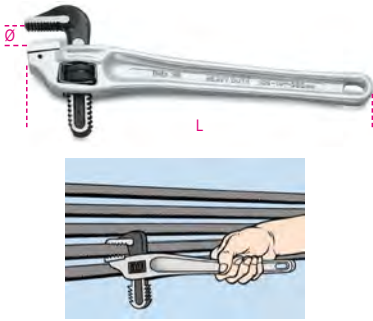

L mm	Ø max" gas	Ø max mm	€	🔧	📄
350	2" gas	60	91,50	1	003650035
450	2 1/2" gas	76	126,00	1	003650045

### 365R/...

kit peças de substituição para ref. 365 com: mordente fixa, mordente móvel; porca; pino de segurança.

	€	🔧	📄
365R 350	68,50	1	003650235
365R 450	102,00	1	003650245

### 366

chaves para tubos modelo ligeiro



L mm	Ø max" gas	Ø max mm	€	🔧	📄
175	1" gas	34	34,50	1	003660017
225	1 1/2" gas	49	41,00	1	003660022
275	2" gas	60	49,50	1	003660027
300	2 1/2" gas	76	54,00	1	003660030

### 374

chaves para tubos modelo Sueco mordentes a 45°



DIN 5234

L mm	Ø max" gas	Ø max mm	€	🔧	📄
240	1/2" gas	21	40,00	1	003740024
320	1" gas	34	54,00	1	003740032
410	1 1/2" gas	49	70,50	1	003740041
550	2" gas	60	110,00	1	003740055
630	3" gas	90	196,00	1	003740063

### 375

chave para tubos modelo Sueco com mordentes a 45°



DIN 5234

L mm	Ø max" gas	Ø max mm	€	🔧	📄
320	1" gas	34	54,00	1	003750032
410	1 1/2" gas	49	70,50	1	003750041
550	2" gas	60	110,00	1	003750055

### 376

chaves para tubos modelo Sueco mordentes planos a 90°



DIN 5234

L mm	Ø max" gas	Ø max mm	€	🔧	📄
320	1" gas	34	54,00	1	003760032
410	1 1/2" gas	49	70,50	1	003760041
550	2" gas	60	110,00	1	003760055
630	3" gas	90	200,00	1	003760063

### 378

chaves para tubos modelo Sueco mordentes a 45°



DIN 5234

L mm	Ø max" gas	Ø max mm	€	🔧	📄
250	1/2" gas	21	42,50	1	003780025
320	1" gas	34	56,50	1	003780032
410	1 1/2" gas	49	73,00	1	003780041
550	2" gas	60	121,00	1	003780055
650	3" gas	90	203,00	1	003780065

### 374R/...

kit completo peças de substituição para refs. 374 - 375 - 376 - 378 com porca e batente

	€	🔧	📄
374R 240 x 374/240-378/250	2,38	1	003740724
374R 320 x 374/320-376/320-378/320	2,64	1	003740732
374R 410 x 374/410-375/410-376/410-378/410	3,25	1	003740741
374R 550 x 374/550-376/550-378/550	3,90	1	003740755
374R 630 x 374/630-378/650	5,90	1	003740763

### 383

chaves para tubos de correia



	Ø max" gas	Ø max mm	L mm	€	🔧	📄
383/1	3" gas	90	300	57,50	1	003830001
383/2	8" gas	220	300	61,00	1	003830002

### 383R

correia de substituição para o modelo 383



	S mm	€	🔧	📄
383R/1	27	23,40	1	003830010
383R/2	27	24,70	1	003830015

### 384

chave de corrente para tubos reversível



	Ø max" gas	Ø max mm	L mm	€	🔧	📄
384	4" gas	115	300	78,00	1	003840032

### 384RC

corrente de substituição para o modelo 384



	€	🔧	📄
384RC	48,00	1	003840033

### 386A

chaves de corrente reversíveis, para trabalhos pesados



	Ø max" gas	L mm	€	🔧	📄
386A/1	4" gas 115 mm	900	264,00	1	003860001
386A/2	6" gas 168 mm	900	489,00	1	003860002
386A/5	8" gas 220 mm	1100	630,00	1	003860005
386A/6	12" gas 324 mm	1300	1.100,00	1	003860006



## 386A/RC

correntes de substituição para o modelo 386A



	€		
386A1/RC	82,50	1	003860011
386A2/RC	117,00	1	003860012
386A5/RC	156,00	1	003860015
386A6/RC	274,00	1	003860016

## 387

alicate dobra-tubos para cobre e metal não ferroso, com matrizes intercambiáveis 3/16"-1/4"-5/16"-3/8"



L mm	€		
255 3/16"-1/4"-5/16"-3/8"	52,50	1	003870001

## 387R

matrizes de substituição para item 387



Ø"	€		
3/16"-1/4"	13,30	1	003870010
5/16"-3/8"	14,00	1	003870015

## 388

curva tubos para tubos de baixa espessura em cobre, ligas leves ou aço macio

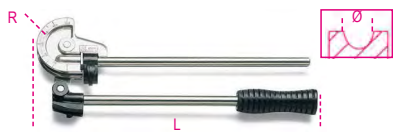

Ø mm	L mm	R mm	€		
6	305	18,0	66,00	1	003880006
8	315	23,5	71,00	1	003880008
10	350	31,0	82,00	1	003880010
12	360	31,0	87,00	1	003880012
15	465	46,5	120,00	1	003880015

## 388A

alicate curva-tubos para tubos de baixa espessura em cobre e ligas leves



	Ø	L mm	€		
388A/1	6-8-10 mm	220	71,50	1	003880051
388A/2	1/4"-5/16"-3/8"	220	71,50	1	003880055

## 388C/C8

curvadora de tubos com 7 matrizes, para tubos finos de cobre e liga leve



	Ø mm	€		
388C/C8	10-12-14-16-18-20-22	525,00	1	003880200

400x330x110 mm - 3,6 kg

## 389/K4

kit de molas curva-tubos para tubos em cobre utilização externa



1/4-3/8-1/2-5/8	L mm	€		
	290	22,10	1	003890001

## 392C

alicate ajustável para sifões



Ø mm	L mm	€		
25÷65	260	49,00	1	003920100

## 392RG/C

par de protectores de substituição para ref. 392C



392RG/C	€		
	6,80	1	003920101

## 393

alicate para porcas de torneira



L mm	€		
270	71,50	1	003930001

## 395

chave articulada para porcas de lavatórios

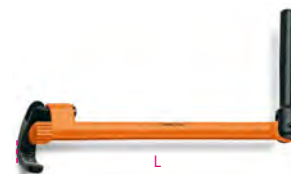

15÷32 mm	L mm	€		
5/8"±1"1/4	240	47,00	1	003950001

## 395T

chave articulada telescópica para porcas de lavatórios



10÷32 mm	L mm	€		
3/8"±1"1/4	250÷430	63,50	1	003950100

## 398

torno de bancada com corrente



Ø	L mm	€		
1/2÷8"	250	325,00	1	003980008

## 399

torno de bancada

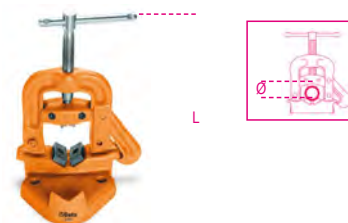

Ø	L min mm	€		
10÷60 mm	220	200,00	1	003990005
1/8÷2"				
10÷89 mm	290	358,00	1	003990010
1/8÷3"				

## 399R/...

kit de substituição para item 399 inclui dois mordentes inferiores e um mordente superior



399RG 1/8-2"	€		
	26,00	1	003990105
399RG 1/8-3"	41,50	1	003990110



# QUADRO DE BROCAS HELICOIDAIS

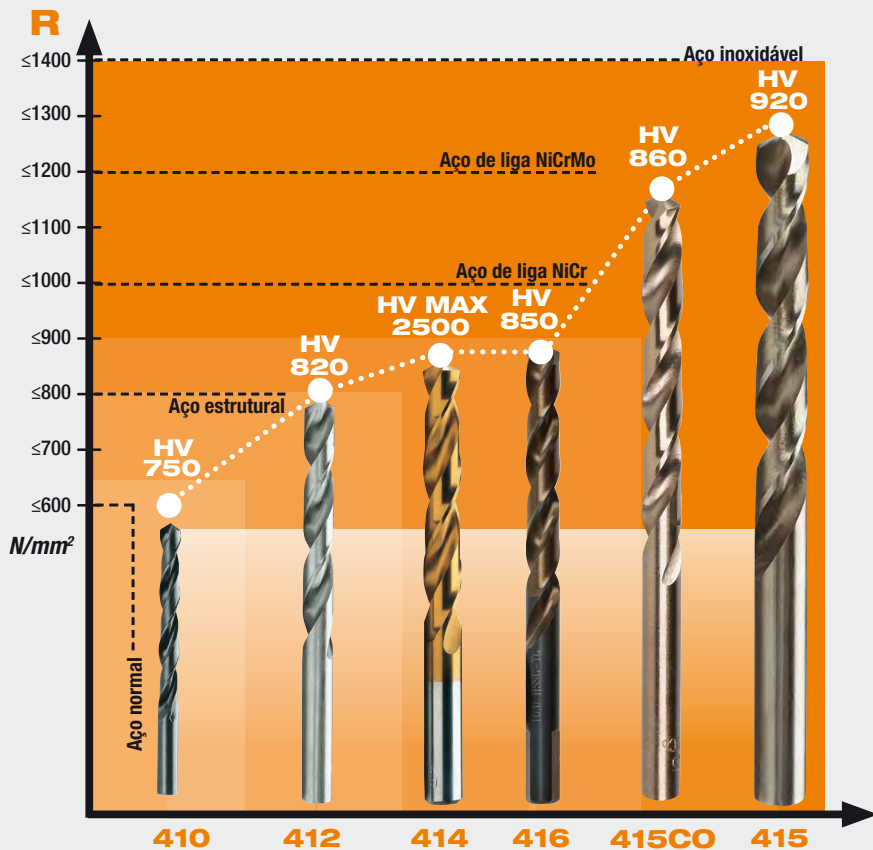

**R N/mm²** - Resistência mecânica do material à broca.

**HV** - Dureza da broca helicoidal de acordo com a escala Vickers: quanto mais elevado for o valor, maior a dureza do material.

## GUIA PARA BROCAS HELICOIDAIS COM VEIO CILÍNDRICO

**Brocas helicoidais** - Brocas helicoidais obtidas a partir de processo de laminagem a quente. Brocas de boa qualidade, para trabalhos leves, ex. furação em ferro, aço macio, ligas leves e metais não-ferrosos em geral.

**Brocas helicoidais retificadas** - Brocas helicoidais totalmente obtidas a partir de retificação de barra de aço com tratamento a quente. Brocas de alta performance para furar aço e ligas leves: eficiência constante, excelente remoção de aparas e precisão ao furar.

**HSS** - Aço de alta velocidade, extremamente duro, e resistente a altas temperaturas; o melhor material para ferramentas de corte, de rosca e escarear.

**Cobalto (Co)** - Elemento à base de ligas, que fornece ao aço uma maior capacidade de resistência ao calor e menor desgaste da broca, por ex., a altas temperaturas. Quanto maior o índice de cobalto, melhor a performance da ferramenta. As ligas mais comuns possuem 5% ou 8% de cobalto

**HSS-Co** - Aço de alta velocidade com 5% ou 8% de cobalto.

**TiN** - Revestimento ultrafino de nitrito de titânio; com base no seu fator de elevada dureza e baixa fricção, proporciona maior resistência ao desgaste e oxidação, bem como uma melhor remoção de aparas.

**Aço cromado** - As ferramentas em aço cromado são adequadas para utilização manual ao rosca ferro, ligas leves, aço sem tratamento e aço com tratamento a quente de baixa dureza. São muito utilizadas na limpeza e reparação de roscas danificadas em todos os trabalhos profissionais em geral e no setor automóvel em particular.

**Metal duro** - Material com elevada resistência ao desgaste, utilizado em chapas para brocas de alvenaria.

**Afição 118°** - Ângulo de afiação standard de brocas helicoidais para metal, que permite furar metais rapidamente, para uma centragem mais fácil e excelente dissipação de calor.

**Afição 130°** - Ângulo de afiação amplo, para mais precisão em operações de perfuração prévias e necessitando de menos força ao furar.

**Afição dupla 115°/135°** - Benefícios combinados dos dois ângulos, mais função de quebra de aparas; a melhor escolha para matérias que produzem aparas longas.

**SDS-Plus** - Rapidez, a escolha mais segura para brocas de percussão.

## 410

brocas cilíndricas série curta HSS

R ≤ 650 N/mm²  
HV || 750+820



DIN 338 ISO 235

Ø mm	L mm	L1 mm	€	🔧	📦
0,50	22	6	1,81	10	004100030
1,00	34	12	1,00	10	004100040
1,25	38	16	0,83	10	004100043
1,50	40	18	0,77	10	004100046
1,75	46	22	0,77	10	004100049
2,00	49	24	0,71	10	004100052
2,25	53	27	0,83	10	004100055
2,50	57	30	0,77	10	004100058
2,75	61	33	0,83	10	004100061
3,00	61	33	0,77	10	004100064
3,20	65	36	1,05	10	004100066
3,25	65	36	1,05	10	004100067
3,50	70	39	0,98	10	004100070
3,75	70	39	1,18	10	004100073
4,00	75	43	1,08	10	004100076
4,20	75	43	1,35	10	004100078
4,25	75	43	1,35	10	004100079
4,50	80	47	1,21	10	004100082
4,75	80	47	1,40	10	004100085
5,00	86	52	1,33	10	004100088
5,25	86	52	1,90	10	004100091
5,50	93	57	1,78	10	004100094
5,75	93	57	1,94	10	004100097
6,00	93	57	1,78	10	004100100
6,25	101	63	2,31	10	004100103
6,50	101	63	2,18	10	004100106
6,75	109	69	2,78	10	004100109
7,00	109	69	2,57	10	004100112
7,50	109	69	2,70	10	004100118
8,00	117	75	3,20	10	004100124
8,50	117	75	3,40	10	004100130
9,00	125	81	4,10	5	004100136
9,50	125	81	4,50	5	004100142
10,00	133	87	4,95	5	004100148
10,50	133	87	6,00	5	004100172
11,00	142	94	7,10	5	004100184
11,50	142	94	7,40	5	004100196
12,00	151	101	8,10	5	004100210
12,50	151	101	8,90	5	004100222
13,00	151	101	9,40	5	004100234
14,00	160	108	12,50	5	004100242
15,00	169	114	14,50	5	004100250
16,00	178	120	18,10	5	004100258
17,00	184	125	20,00	3	004100262
18,00	191	130	23,70	3	004100266
19,00	198	135	27,00	3	004100270
20,00	205	140	32,00	3	004100274



Broca	€	🔧	📦
410/SP19 Ø 1÷10 x 0,5 mm	52,00	1	004100419
410/SPVP1	29,00	1	004100421
410/SP25 Ø 1÷13 x 0,5 mm	109,00	1	004100425
410/SPVP2	40,00	1	004100427



**410/SEL19** € 40,50 1 004100418  
 Ø 1÷10 x 0,5 mm

### 410MIX/SEL19

jogo de 13 brocas 410  
 e 6 com inserção de metal duro



**410MIX/SEL19** € 40,50 1 004100417



Ø 1 - 1,5 - 2 - 2,5 - 3 - 3,5 - 4  
 4,5 - 5 - 5,5 - 6 - 8 - 10 mm

Ø 4 - 5 - 6 - 8 - 9 - 10 mm

### 410A

brocas cilíndricas série curta HSS

R ≤ 650 N/mm<sup>2</sup>  
 HV ~ 750÷820



DIN 338 ISO 235

Ø mm	L mm	L1 mm	€	1	004100281
13,50	160	108	14,70	5	004100281
14,00	160	108	14,70	5	004100283
14,50	169	114	17,10	5	004100285
15,00	169	114	17,10	5	004100287
15,50	178	120	21,10	5	004100289
16,00	178	120	21,10	5	004100291
16,50	184	125	22,20	3	004100292
17,00	184	125	22,20	3	004100293
17,50	191	130	26,50	3	004100294
18,00	191	130	26,50	3	004100295
18,50	198	135	29,50	3	004100296
19,00	198	135	29,50	3	004100297
19,50	205	140	34,50	3	004100298
20,00	205	140	34,50	3	004100299



### 412

brocas cilíndricas série curta  
 HSS - totalmente rectificadas

R ≤ 700 N/mm<sup>2</sup>  
 HV 750÷820



DIN 338 ISO 235

Ø mm	L mm	L1 mm	€	10	004120030
0,50	22	6	3,15	10	004120030
1,00	34	12	2,02	10	004120040
1,25	38	16	2,16	10	004120043
1,50	40	18	1,81	10	004120046
1,75	46	22	1,81	10	004120049
2,00	49	24	1,53	10	004120052
2,25	53	27	1,94	10	004120055
2,50	57	30	1,67	10	004120058
2,75	61	33	1,94	10	004120061
3,00	61	33	1,75	10	004120064
3,25	65	36	2,29	10	004120067
3,50	70	39	2,10	10	004120070
3,75	70	39	2,51	10	004120073
4,00	75	43	2,29	10	004120076
4,25	75	43	2,93	10	004120079
4,50	80	47	2,63	10	004120082
4,75	80	47	3,15	10	004120085
5,00	86	52	2,93	10	004120088
5,25	86	52	4,15	10	004120091
5,50	93	57	3,80	10	004120094
5,75	93	57	4,65	10	004120097
6,00	93	57	4,00	10	004120100
6,25	101	63	5,80	10	004120103
6,50	101	63	5,10	10	004120106
6,75	109	69	6,50	10	004120109
7,00	109	69	6,00	10	004120112
7,25	109	69	7,30	5	004120115
7,50	109	69	6,20	5	004120118
7,75	117	75	8,30	5	004120121
8,00	117	75	7,60	5	004120124
8,25	117	75	9,30	5	004120127
8,50	117	75	9,40	5	004120130
8,75	125	81	10,30	5	004120133
9,00	125	81	9,80	5	004120136
9,25	125	81	11,30	5	004120139
9,50	125	81	10,20	5	004120142
9,75	133	87	12,60	5	004120145
10,00	133	87	11,30	5	004120148
10,25	133	87	17,20	5	004120149
10,50	133	87	15,10	5	004120150
10,75	142	94	20,50	5	004120151
11,00	142	94	18,00	5	004120152
11,25	142	94	21,80	5	004120153
11,50	142	94	19,00	5	004120154
11,75	142	94	23,70	5	004120155
12,00	151	101	20,90	5	004120156
12,25	151	101	26,00	5	004120157
12,50	151	101	22,30	5	004120158
12,75	151	101	29,50	5	004120159
13,00	151	101	23,60	5	004120160



<b>412/SP19</b>	€ 104,00	1	004120419
Ø 1÷10 x 0,5 mm			
<b>410/SPVP1</b>	29,00	1	004100421
<b>412/SP25</b>	214,00	1	004120425
Ø 1÷13 x 0,5 mm			
<b>410/SPVP2</b>	40,00	1	004100427
<b>412/SP49</b>	515,00	1	004120449
Ø 1÷13 x 0,25 mm			
<b>412/SPV4</b>	122,00	1	004120451

### 412/C150



**412/C150** € 625,00 1 004120450

412 Ø 3 mm n. 20  
 Ø 1 - 1,5 - 2 - 2,5 - 3 - 3,5 - 4 - 4,5 - 5 mm 10  
 Ø 5,5 - 6 - 6,5 - 7 - 7,5 - 8 - 8,5 - 9 - 9,5 - 10 mm 5  
 365x230x47 mm - 3,3 kg



**412/SP91** € 665,00 1 004120452  
 Ø 1÷10 x 0,10 mm

### 412A

brocas cilíndricas série curta  
 HSS - totalmente rectificadas  
 e acabamento brunido

R ≤ 800 N/mm<sup>2</sup>  
 HV ~ 750÷820



DIN 338 ISO 235

Ø mm	L mm	L1 mm	€	3	004120202
13,50	160	108	38,00	3	004120202
14,00	160	108	39,50	3	004120204
14,50	169	114	42,00	3	004120206
15,00	169	114	44,00	3	004120208
15,50	178	120	51,00	3	004120210
16,00	178	120	52,50	3	004120212
16,50	184	125	54,00	1	004120213
17,00	184	125	58,00	1	004120214
17,50	191	130	62,00	1	004120215
18,00	191	130	65,50	1	004120216
18,50	198	135	70,50	1	004120217
19,00	198	135	72,50	1	004120218
19,50	205	140	81,50	1	004120219
20,00	205	140	83,00	1	004120220

## 412L

brocas cilíndricas série longa  
HSS - totalmente rectificadas  
e acabamento bruido

R ≤ 800 N/mm<sup>2</sup>  
HV || 750+820



DIN 340

Ø mm	L mm	L1 mm	€	🔧	📦
2,00	85	56	4,15	10	004120232
2,50	95	62	4,40	10	004120234
3,00	100	66	4,65	10	004120236
3,50	112	73	5,30	10	004120238
4,00	119	78	5,80	10	004120240
4,50	126	82	7,00	10	004120242
5,00	132	87	7,30	10	004120244
5,50	139	91	9,30	10	004120246
6,00	139	91	9,90	10	004120248
6,50	148	97	11,80	5	004120250
7,00	156	102	13,80	5	004120252
8,00	165	109	18,40	5	004120256
9,00	175	115	21,60	5	004120260
10,00	184	121	23,70	5	004120264

## 412XL

brocas helicoidais, com veio cilíndrico, série extra longa, HSS, totalmente retificadas

R ≤ 800 N/mm<sup>2</sup>  
HV ~ 750+820



DIN 1869/1

Ø mm	L mm	L1 mm	€	🔧	📦
3,00	150	100	16,00	1	004120520
3,50	165	115	17,60	1	004120522
4,00	175	120	17,60	1	004120524
4,50	185	125	18,10	1	004120526
5,00	195	135	18,10	1	004120528
5,50	205	140	22,30	1	004120530
6,00	205	140	22,30	1	004120532
6,50	215	150	26,50	1	004120534
7,00	225	155	30,50	1	004120536
7,50	225	155	35,50	1	004120538
8,00	240	165	37,50	1	004120540
8,50	240	165	39,50	1	004120542
9,00	250	175	50,50	1	004120544
9,50	250	175	54,00	1	004120546
10,00	265	185	54,00	1	004120548
10,50	265	185	54,00	1	004120550
11,00	280	195	54,00	1	004120552
12,00	295	205	69,00	1	004120556
13,00	295	205	71,50	1	004120560

## 414

brocas cilíndricas série curta  
HSS-TIN - totalmente rectificadas

R ≤ 900 N/mm<sup>2</sup>  
HV 0,05 || 2500



DIN 338 ISO 235

Ø mm	L mm	L1 mm	€	🔧	📦
1,00	34	12	2,74	10	004140040
1,25	38	16	3,15	10	004140042
1,50	40	18	2,44	10	004140046
1,75	46	22	3,15	10	004140048
2,00	49	24	2,57	10	004140052
2,25	53	27	3,20	10	004140054
2,50	57	30	2,70	10	004140058
2,75	61	33	3,70	10	004140060
3,00	61	33	3,05	10	004140064
3,25	65	36	3,90	10	004140066
3,50	70	39	3,70	10	004140070
3,75	70	39	4,10	10	004140072
4,00	75	43	3,70	10	004140076
4,25	75	43	4,50	10	004140078
4,50	80	47	4,10	10	004140082
4,75	80	47	5,20	10	004140084
5,00	86	52	4,80	10	004140088
5,25	86	52	6,70	10	004140090
5,50	93	57	5,80	10	004140094
5,75	93	57	7,00	10	004140096
6,00	93	57	6,40	10	004140100
6,25	101	63	8,10	10	004140102
6,50	101	63	7,10	10	004140106
6,75	109	69	9,80	10	004140108
7,00	109	69	7,80	10	004140112
7,25	109	69	10,80	5	004140114
7,50	109	69	9,60	5	004140118
7,75	117	75	12,60	5	004140120
8,00	117	75	11,30	5	004140124
8,25	117	75	13,10	5	004140125
8,50	117	75	11,70	5	004140130
8,75	125	81	16,30	5	004140132
9,00	125	81	14,50	5	004140136
9,25	125	81	18,60	5	004140138
9,50	125	81	16,30	5	004140142
9,75	133	87	19,50	5	004140144
10,00	133	87	17,30	5	004140148
10,50	133	87	20,20	5	004140150
11,00	142	94	21,80	5	004140152
11,50	142	94	23,70	5	004140154
12,00	151	101	25,50	5	004140156
12,50	151	101	29,50	5	004140158
13,00	151	101	30,50	5	004140160



Model	€	🔧	📦
414/SP19	151,00	1	004140419
410/SPVP1	29,00	1	004100421
414/SP25	306,00	1	004140425
410/SPVP2	40,00	1	004100427
414/SP49	675,00	1	004140429
414/SPV4	122,00	1	004140430

## 414/C116



414/C116	€	🔧	📦
	615,00	1	004140450

414	Ø 1 - 1,5 - 2 - 2,5 - 3 - 3,5 - 4 - 4,5 - 5 mm	n.
		10
	Ø 5,5 - 6 - 6,5 - 7 - 7,5 - 8 mm	3
	Ø 8,5 - 9 - 9,5 - 10 mm	2

📏 365x230x47 mm - 🏠 2,7 Kg

## 415

brocas cilíndricas série curta  
HSS-CO 8% - totalmente rectificadas

R ≤ 1400 N/mm<sup>2</sup>  
HV || 850+920



DIN 338 ISO 235

Ø mm	L mm	L1 mm	€	🔧	📦
0,50	22	6	7,70	10	004150029
1,00	34	12	3,80	10	004150040
1,25	38	16	4,20	10	004150043
1,50	40	18	3,80	10	004150046
1,75	46	22	4,00	10	004150049
2,00	49	24	3,70	10	004150052
2,25	53	27	4,50	10	004150055
2,50	57	30	4,10	10	004150058
2,75	61	33	4,50	10	004150061
3,00	61	33	4,15	10	004150064
3,25	65	36	5,80	10	004150067
3,50	70	39	5,30	10	004150070
3,75	70	39	6,40	10	004150073
4,00	75	43	5,80	10	004150076
4,25	75	43	7,20	10	004150079
4,50	80	47	6,50	10	004150082
4,75	80	47	7,50	10	004150085
5,00	86	52	7,00	10	004150088
5,25	86	52	10,20	10	004150091
5,50	93	57	9,30	10	004150094
5,75	93	57	10,70	10	004150097
6,00	93	57	9,80	10	004150100
6,25	101	63	13,80	10	004150103
6,50	101	63	12,00	10	004150106
6,75	109	69	15,90	10	004150109
7,00	109	69	14,20	10	004150112
7,25	109	69	17,20	5	004150115
7,50	109	69	15,40	5	004150118
7,75	117	75	20,10	5	004150121
8,00	117	75	18,10	5	004150124
8,25	117	75	21,80	5	004150127
8,50	117	75	20,50	5	004150130
8,75	125	81	27,00	5	004150133
9,00	125	81	23,90	5	004150136
9,25	125	81	28,50	5	004150139
9,50	125	81	26,00	5	004150142
9,75	133	87	30,50	5	004150145
10,00	133	87	28,50	5	004150148
10,25	133	87	36,50	5	004150149
10,50	133	87	31,00	5	004150150
10,75	142	94	40,50	5	004150151
11,00	142	94	36,50	5	004150152
11,25	142	94	45,50	5	004150153
11,50	142	94	40,00	5	004150154
11,75	142	94	46,50	5	004150155





Ø mm	L mm	L1 mm	€	🔧	📄
12,00	151	101	43,00	5	004150156
12,25	151	101	55,50	5	004150157
12,50	151	101	46,50	5	004150158
12,75	151	101	60,50	5	004150159
13,00	151	101	49,50	5	004150160
14,00	160	108	87,50	3	004150164
15,00	169	114	104,00	3	004150168
16,00	178	120	127,00	3	004150172
17,00	186	125	144,00	1	004150174
18,00	194	130	160,00	1	004150176
19,00	202	135	184,00	1	004150178
20,00	210	140	207,00	1	004150180



Co8%

	€	🔧	📄
415/SP19 Ø 1÷10 x 0,5 mm	213,00	1	004150419
410/SPVP1	29,00	1	004100421
415/SP25 Ø 1÷13 x 0,5 mm	440,00	1	004150425
410/SPVP2	40,00	1	004100427
415/SP49 Ø 1÷13 x 0,25 mm	1.100,00	1	004150431
415/SPV4	122,00	1	004150432

## 415/C116



415/C116	€	🔧	📄
930,00	1	004150450	n.
415			10
Ø 1 - 1,5 - 2 - 2,5 - 3 - 3,5 - 4 - 4,5 - 5 mm			3
Ø 5,5 - 6 - 6,5 - 7 - 7,5 - 8 mm			2
Ø 8,5 - 9 - 9,5 - 10 mm			
365x230x47 mm - 2,7 kg			



415/SP91	€	🔧	📄
1.280,00	1	004150460	
Ø 1÷10 x 0,10 mm			

## 415CO

brocas helicoidais, com veio cilíndrico, série curta, HSS-CO 5%, totalmente retificadas

R ≤ 1200 N/mm<sup>2</sup>  
HV ~ 800=860



DIN 338 ISO 235

Ø mm	L mm	L1 mm	€	🔧	📄
1,00	34	12	1,94	10	004150310
1,50	40	18	1,94	10	004150312
2,00	49	24	1,94	10	004150314
2,50	57	30	2,02	10	004150316
3,00	61	33	2,02	10	004150320
3,50	70	39	2,51	10	004150322
4,00	75	43	2,93	10	004150324
4,50	80	47	3,40	10	004150326
5,00	86	52	3,50	10	004150328
5,50	93	57	4,40	10	004150330
6,00	93	57	4,90	10	004150332
6,50	101	63	5,90	10	004150334
7,00	109	69	7,20	10	004150336
7,50	109	69	7,90	5	004150338
8,00	117	75	9,40	5	004150340
8,50	117	75	9,80	5	004150342
9,00	125	81	11,90	5	004150344
9,50	125	81	12,60	5	004150346
10,00	133	87	14,50	5	004150348
10,50	133	87	17,60	5	004150350
11,00	142	94	19,50	5	004150352
11,50	142	94	21,40	5	004150354
12,00	151	101	23,40	5	004150356
12,50	151	101	25,50	5	004150358
13,00	151	101	28,00	5	004150360

## 415CO-A

brocas helicoidais, com veio cilíndrico, série curta, HSS-CO 5%, totalmente retificadas

R ≤ 1200 N/mm<sup>2</sup>  
HV ~ 800=860



DIN 338

Ø mm	L mm	L1 mm	€	🔧	📄
14,00	160	108	54,00	3	004150364
15,00	169	114	62,50	3	004150366
16,00	178	120	75,50	3	004150368
17,00	184	125	77,00	1	004150370
18,00	191	130	99,00	1	004150372
19,00	198	135	114,00	1	004150374
20,00	205	140	132,00	1	004150376



Co5%

415CO/SP19	€	🔧	📄
112,00	1	004150421	
Ø 1÷10 x 0,5 mm			
410/SPVP1	29,00	1	004100421

## 415L

brocas helicoidais com veio cilíndrico, série longa, HSS-CO 5%, totalmente retificadas

R ≤ 1200 N/mm<sup>2</sup>  
HV ~ 800=860



DIN 340

Ø mm	L mm	L1 mm	€	🔧	📄
3,00	100	66	5,30	10	004150236
3,50	112	73	5,90	10	004150238
4,00	119	78	7,20	10	004150240
4,50	126	82	8,90	10	004150242
5,00	132	87	9,30	10	004150244
5,50	139	91	11,50	10	004150246
6,00	139	91	12,60	10	004150248
6,50	148	97	14,80	5	004150250
7,00	156	102	17,60	5	004150252
8,00	165	109	22,30	5	004150256
9,00	175	115	28,00	5	004150260
10,00	184	121	36,00	5	004150264

## 416

broca cilíndrica, para furar chão, com duas lâminas

R ≤ 900 N/mm<sup>2</sup>  
HV || 820=850



DIN 338 ISO 235

Ø mm	L mm	L1 mm	€	🔧	📄
1,00	34	12	2,99	10	004160010
1,50	40	18	2,99	10	004160015
2,00	49	24	2,99	10	004160020
2,50	57	30	3,15	10	004160025
3,00	61	33	3,40	10	004160030
3,50	70	39	3,75	10	004160035
4,00	75	43	4,15	10	004160040
4,50	80	47	4,65	10	004160045
5,00	86	52	5,30	10	004160050
5,50	93	57	6,80	10	004160055
6,00	93	57	7,20	10	004160060
6,50	101	63	8,60	10	004160065
7,00	109	69	9,90	10	004160070
7,50	109	69	10,70	5	004160075
8,00	117	75	12,70	5	004160080
8,50	117	75	13,80	5	004160085
9,00	125	81	16,10	5	004160090
9,50	125	81	17,30	5	004160095
10,00	133	87	19,90	5	004160100



416/SP19	€	🔧	📄
150,00	1	004160419	
Ø 1÷10 x 0,5 mm			
410/SPVP1	29,00	1	004100421

## 416P/SP19

conjunto de 19 brocas cilíndricas, em HSS, AISI M2, com boca mais pequena para centragem de elevada precisão

Ø 1=10 x 0,5 mm  
R ≤ 900 N/mm<sup>2</sup>  
HV ~ 820÷850

**MAIOR VELOCIDADE AO FURAR**



416P/SP19  
Ø 1=10 x 0,5 mm  
115x170x40 mm

€ 163,00 1 004160469

## 417

brocas cilíndricas para pedra, série curta em aço fresado, com ponta em diamante



DIN 8039

Ø mm	L mm	€	1	004170003
3	70	4,00	10	004170003
4	75	4,00	10	004170004
5	85	4,20	10	004170005
5L	150	9,50	5	004170105
6	100	4,35	10	004170007
6L	150	9,50	5	004170106
7	120	4,90	10	004170009
8	120	5,40	10	004170010
8L	200	10,30	5	004170113
9	120	6,20	10	004170011
10	120	7,20	10	004170012
10L	200	12,40	5	004170120
12	150	9,40	10	004170014
12L	200	13,50	5	004170125
14	150	13,00	5	004170016
16	150	16,10	5	004170018



417/SP8  
Ø 3-4-5-6-8-9-10-12 mm

€ 60,50 1 004170100

## 418/K3

jogo de ponteiro e escopros para pedreiro com ligação SDS-plus

jogo de ponteiro e escopros para pedreiro com ligação SDS-plus



L mm	A mm	A1 mm	€	1	004180103
250	20	40	38,00	1	004180103

## 419

brocas para pedra, corpo fresado com ponta em diamante

HVA~ 1650



Ø mm	L mm	€	10	004190002
4	110	8,20	10	004190002
5	110	8,20	10	004190004
5	160	9,10	10	004190006
6	110	8,10	10	004190012
6	160	8,90	10	004190014
6	210	11,80	10	004190016
7	160	9,80	10	004190028
8	110	8,70	10	004190030
8	160	9,40	10	004190032
8	210	11,30	10	004190034
8	260	15,30	10	004190036
8	310	18,80	10	004190038
8	460	34,50	10	004190042
9	160	11,50	5	004190044
10	160	11,80	5	004190050
10	210	13,70	5	004190052
10	260	17,10	5	004190054
10	310	23,90	5	004190056
10	460	37,50	5	004190060
12	160	13,10	5	004190064
12	210	17,80	5	004190066
12	260	19,10	5	004190068
12	460	39,50	5	004190074
14	160	18,10	3	004190086
14	260	21,80	3	004190090
14	310	31,00	3	004190092
14	460	40,50	3	004190096
16	210	27,00	3	004190112
16	260	28,50	3	004190114
16	310	34,50	3	004190116
16	460	45,50	3	004190120
18	260	36,50	1	004190124
20	310	36,50	1	004190128



419/SP7  
Ø 5 - 6 - 8 x 110 mm  
Ø 6 - 8 - 10 - 12 x 160 mm

€ 84,00 1 004190507

## 419T

brocas SDS Plus com veio retificado, com 4 espirais e 4 cortantes

HVA~ 1650

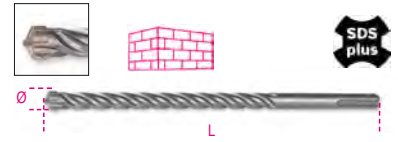

Ø mm	L mm	€	5	004190604
5	110	5,60	5	004190604
5	160	6,30	5	004190606
6	110	5,90	5	004190612
6	160	6,90	5	004190614
6	210	9,40	5	004190616
7	160	7,00	5	004190628
8	110	6,40	5	004190630
8	160	7,20	5	004190632
8	210	9,60	5	004190634
8	260	10,90	5	004190636
8	310	13,50	5	004190638
9	160	7,70	3	004190644
10	160	7,70	3	004190650
10	210	10,30	3	004190652
10	260	11,20	3	004190654
10	310	16,00	3	004190656
10	460	21,60	3	004190660
12	160	8,70	3	004190664
12	210	11,30	3	004190666
12	260	11,90	3	004190668
12	460	22,30	3	004190674
14	160	11,70	2	004190686
14	260	13,70	2	004190690
14	310	19,30	2	004190692
14	460	21,60	2	004190696
16	210	15,50	2	004190712
16	260	20,50	2	004190714
16	310	22,20	2	004190716
16	460	22,90	2	004190720
18	260	25,00	1	004190724
20	310	30,50	1	004190728

## 420D/SP8

jogo de 8 brocas cilíndricas, para madeira, série curta, 2 cortantes, guia de centragem



420D/SP8  
Ø 3 - 4 - 5 - 6 - 7 - 8 - 9 - 10 mm

€ 20,80 1 004200200

## 421

Jogo de 6 escareadores com pino guia, qualidade superior, em HSS

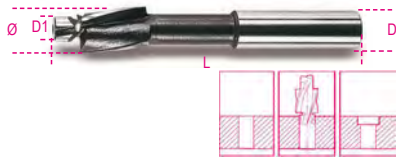

DIN 373

M	L mm	Ø mm	D1 mm	D mm	€		
3	71	6	3,2	5	30,00	1	004210003
4	71	8	4,3	5	30,00	1	004210004
5	80	10	5,3	8	30,00	1	004210005
6	80	11	6,4	8	30,50	1	004210006
8	100	15	8,4	12,5	49,50	1	004210008
10	100	18	10,5	12,5	59,00	1	004210010
12	100	20	13,0	12,5	64,00	1	004210012



421/SP6	€		
M 3-4-5-6-8-10	244,00	1	004210019
421/SPV	18,10	1	004210020

## 422

pontas de centrar, ângulo de escarear 60°, em HSS

• Para realizar furos de forma rápida e segura



DIN 333/A

Ø mm	D mm	L mm	€		
1,60	4,0	35,5	9,50	1	004220116
2,50	6,3	45,0	10,90	1	004220125
3,15	8,0	50,0	12,30	1	004220131

## 423CO

brocas especiais para soldadura por pontos em HSS-CO 5% retificadas



Ø mm	L mm	€		
6	66	18,80	5	004230106
7	74	22,90	5	004230107
8	80	25,00	5	004230108
10	89	29,50	5	004230110

## 423A-CO

brocas especiais com ponta de centragem para soldadura por pontos em HSS-CO 5% retificadas



DIN 1412/E

Ø mm	L mm	€		
6,5	40	28,00	1	004230115
8,0	40	30,00	1	004230120

## 424

brocas cónicas para furar e alargar em HSS

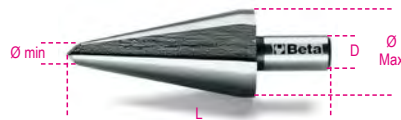

	L mm	Ø mm	D mm	€		
424/1	58	3÷14	6	35,00	2	004240001
424/2	71	4÷20	8	58,50	2	004240002
424/3	76	16÷30,5	9	100,00	2	004240003
424/4	79	5÷22,5	8	123,00	1	004240004
424/5	103	5÷31	9	165,00	1	004240005
424/6	89	24÷40	10	210,00	1	004240006
424/7	97	36÷50	12	314,00	1	004240007
424/8	103	40÷61	13	520,00	1	004240008



424/SP3	€		
424/1+424/2+424/3	201,00	1	004240019
Ø 3÷30,5 mm			
424/SPV	28,00	1	004240020

## 425

fresas cónicas de diâmetros múltiplos em HSS



	L mm	Ø mm	S mm	D mm	€		
425/1	70	4÷12	1	6	59,00	2	004250010
425/2	55	4÷12	2	6	62,50	2	004250012
425/3	85	4÷20	2	10	90,50	2	004250015
425/4	85	12÷20	1	10	138,00	1	004250016
425/5	97	20÷30	1	10	271,00	1	004250017
425/6	75	4÷30	2	10	189,00	1	004250020
425/7	97	30÷40	1	13	377,00	1	004250025
425/8	100	40÷50	1	13	525,00	1	004250029



425/SP3	€		
425/1+425/3+425/6	345,00	1	004250030
Ø 4÷30 mm			
425/SPV	28,00	1	004250035

## 426

fresas para desbaste e aberturas em HSS, 3 lâminas



DIN 335-C

GR	Ø mm	L mm	Ø1 mm	€		
1	4,3	40	4	19,70	3	004260001
2	5,3	40	4	19,70	3	004260002
3	6,3	45	5	20,50	3	004260003
4	7,3	50	6	24,00	3	004260004
5	8,3	50	6	24,00	3	004260005
6	9,4	50	6	27,00	3	004260006
7	10,4	50	6	30,00	3	004260007
8	12,4	56	8	32,00	3	004260008
9	15,0	60	10	36,50	3	004260009
10	16,5	60	10	38,50	3	004260010
11	20,5	63	10	53,00	3	004260011
12	25,0	67	10	84,00	3	004260012
13	28,0	71	12	113,00	3	004260013
14	31,0	71	12	120,00	3	004260014



DIN 335-C

426/SP6	€		
GR 3-5-7-8-10-11	210,00	1	004260030
Ø 6,3÷20,5 mm			
426/SPV	28,00	1	004260035





## 426A/SP6

conjunto de 6 escareadores,  
com 3 cortantes assimétricos em espiral,  
em HSS

Ø 6.3 - 8.3 - 10.4 - 12.4 - 16.5 - 20.5 mm



426A/SP6 220,00 € 1 004260060  
Ø 6,3-8,3-10,4-12,4-16,5-20,5 mm  
100x145x40 mm

## 426T

escareadores para desbaste com três  
lâminas, HSS + TiN

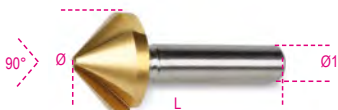

DIN 335-C

GR	Ø mm	L mm	Ø1 mm	€		
1	4,3	44	4	25,50	3	004260061
2	5,3	44	4	25,50	3	004260062
3	6,3	44	5	26,00	3	004260063
4	7,3	44	6	29,50	3	004260064
5	8,3	50	6	29,50	3	004260065
6	9,4	50	6	31,00	3	004260066
7	10,4	54	6	36,50	3	004260067
8	12,4	54	8	38,00	3	004260068
9	15,0	56	10	42,50	3	004260069
10	16,5	60	10	48,00	3	004260070
11	20,5	63	10	62,50	3	004260071
12	25,0	66	10	94,50	3	004260072
13	28,0	71	12	118,00	3	004260073
14	31,0	71	12	127,00	3	004260074



DIN 335-C  
426T/SP6 240,00 € 1 004260080  
GR 3-5-7-8-10-11  
Ø 6,3=20,5 mm  
426/SPV 28,00 € 1 004260035

## 426SB

fresas para desbaste e vazar em HSS



	GR	Ø Min	Ø Max	Ø2	L	€		
	1	2÷5	6	45		26,50	1	004260101
	2	5÷10	8	48		32,50	1	004260102
	3	10÷15	10	65		59,00	1	004260103
	4	15÷20	12	85		114,00	1	004260104
	5	20÷25	12	102		191,00	1	004260105



426SB/SP4 264,00 € 1 004260130  
426/SB1-426/SB2  
426/SB3-426/SB4  
Ø 2÷20 mm  
426SB/SPV1 28,00 € 1 004260135

## 426MD-3/CP3

Conjunto mini fresas rotativas em metal duro

• Corte transversal suave com quebras



L 38,1 mm Ø 3 mm € 14,50 1 004260332

## 426MD-3/CT3

Conjunto mini fresas rotativas em metal duro

• Corte transversal suave com quebras



L 37,8 mm Ø 3 mm € 14,50 1 004260333

## 426MD-3/F3

Conjunto mini fresas rotativas em metal duro

• Corte transversal suave com quebras



L 38,3 mm Ø 3 mm € 14,50 1 004260334

## 426MD-3/FA3

Conjunto mini fresas rotativas em metal duro

• Corte transversal suave com quebras



L 38,2 mm Ø 3 mm € 14,50 1 004260339

## 426MD-3/OG3

Conjunto mini fresas rotativas em metal duro

• Corte transversal suave com quebras



L 38,1 mm Ø 3 mm € 14,50 1 004260337

## 426MD-3/OV3

Conjunto mini fresas rotativas em metal duro

• Corte transversal suave com quebras



L 38,2 mm Ø 3 mm € 14,50 1 004260331

## 426MD-3/S3

Conjunto mini fresas rotativas em metal duro

• Corte transversal suave com quebras



L 38,0 mm Ø 3 mm € 14,50 1 004260338

## 426MD-3/T3

Conjunto mini fresas rotativas em metal duro

• Corte transversal suave com quebras



L 38,3 mm Ø 3 mm € 14,50 1 004260336

## 426MD-3/TA3

Conjunto mini fresas rotativas em metal duro

• Corte transversal suave com quebras



L 38,3 mm Ø 3 mm € 14,50 1 004260335



<b>426MD-3/A9</b>	€ 131,00	1	004260349
426MD-3/OV3 - 426MD-3/CP3			
426MD-3/CT3 - 426MD-3/F3			
426MD-3/TA3 - 426MD-3/T3			
426MD-3/OG3 - 426MD-3/S3			
426MD-3/FA3			

## 426MD/CP

limas rotativas, em metal endurecido

corte transversal HM4



L mm	Ø mm	€	1	004260532
50	6	40,50	1	004260532
63	8	44,50	1	004260512
63	9,5	50,50	1	004260542
69	12	71,00	1	004260522
69	16	102,00	1	004260552

## 426MD/CT

limas rotativas, em metal endurecido

corte transversal HM4



L mm	Ø mm	€	1	004260533
50	6	40,50	1	004260533
63	8	44,50	1	004260513
63	9,5	50,50	1	004260543
69	12	71,00	1	004260523
69	16	98,50	1	004260553

## 426MD/F

limas rotativas, em metal endurecido

corte transversal HM4



L mm	Ø mm	€	1	004260534
50	6	40,50	1	004260534
63	8	44,50	1	004260514
63	9,5	50,50	1	004260544
69	12	71,00	1	004260524
69	16	80,50	1	004260554

## 426MD/FA

limas rotativas, em metal endurecido

corte transversal HM4



L mm	Ø mm	€	1	004260539
50	6	40,50	1	004260539
63	8	44,50	1	004260519
63	9,5	50,50	1	004260549
69	12	71,00	1	004260529
69	16	91,50	1	004260559

L mm	Ø mm	€	1	004260535
50	6	40,50	1	004260535
67	8	44,50	1	004260515
72	9,5	50,50	1	004260545
73	12	71,00	1	004260525
78	16	102,00	1	004260555

## 426MD/OG

limas rotativas, em metal endurecido

corte transversal HM4



L mm	Ø mm	€	1	004260537
50	6	40,50	1	004260537
63	8	44,50	1	004260517
70	10	50,50	1	004260547
76	12	71,00	1	004260527
81	16	102,00	1	004260557

## 426MD/OV

limas rotativas, em metal endurecido

corte transversal HM4



L mm	Ø mm	€	1	004260531
50	6	40,50	1	004260531
61	9,5	50,50	1	004260541
67	12	71,00	1	004260521
69	16	91,50	1	004260551

## 426MD/S

limas rotativas, em metal endurecido

corte transversal HM4



L mm	Ø mm	€	1	004260538
50	6	40,50	1	004260538
51	8	44,50	1	004260518
53	9,5	50,50	1	004260548
56	12	71,00	1	004260528
59	16	80,50	1	004260558

## 426MD/T

limas rotativas, em metal endurecido

corte transversal HM4



L mm	Ø mm	€	1	004260536
50	6	40,50	1	004260536
63	8	44,50	1	004260516
63	9,5	50,50	1	004260546
69	12	71,00	1	004260526
70	16	80,50	1	004260556

## 426MD/TA

limas rotativas, em metal endurecido

corte transversal HM4



L mm	Ø mm	€	1	004260535
50	6	40,50	1	004260535
67	8	44,50	1	004260515
72	9,5	50,50	1	004260545
73	12	71,00	1	004260525
78	16	102,00	1	004260555



<b>426MD/SP10</b>	€ 525,00	1	004260510
426MD/CP-426MD/CT-426MD/F			
426MD/T-426MD/S			
Ø 8-12 mm			

## 427

extractores de cones Morse



DIN 317

GR	L mm	A mm	€	3	004270000
0	92	13	14,10	3	004270000
1-2	140	19	19,90	3	004270002
3	190	25	23,90	3	004270003
4	225	30	40,50	3	004270004
5-6	260	35	74,00	3	004270006

## 428FP

machos mecânicos para furos vazantes  
passo largo em HSS

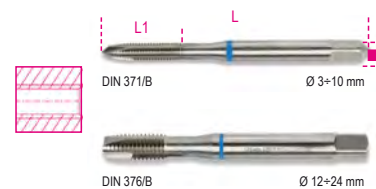

ISO 529

M	mm	L mm	L1 mm	€	10	004280003
3x0,5	2,7	56	11	19,20	10	004280003
4x0,7	3,4	63	13	19,20	10	004280004
5x0,8	4,9	70	16	19,20	10	004280005
6x1	4,9	80	19	20,20	10	004280006
8x1,25	6,2	90	22	24,50	10	004280008
10x1,5	8,0	100	24	29,00	10	004280010
12x1,75	7,0	110	28	37,50	5	004280012
14x2	9,0	110	30	46,00	5	004280014
16x2	9,0	110	32	55,50	5	004280016
18x2,5	11,0	125	34	71,00	3	004280018
20x2,5	12,0	140	34	80,00	3	004280020
22x2,5	14,5	140	34	96,00	3	004280022
24x3	14,5	160	38	105,00	3	004280024

## 428FP/C7

jogo de  
7 machos 428FP,  
em HSS



428FP/C7	€ 120,00	1	004280203
428FP M3÷12			
428F/SPV	€ 20,80	1	004280205

## 428FC

machos mecânicos para furos cegos  
passo largo em HSS



ISO 529

M	mm	L	L1	€		
3x0,5	2,7	56	11	23,30	10	004280103
4x0,7	3,4	63	13	23,30	10	004280104
5x0,8	4,9	70	16	23,30	10	004280105
6x1	4,9	80	19	23,90	10	004280106
8x1,25	6,2	90	22	26,00	10	004280108
10x1,5	8,0	100	24	30,50	10	004280110
12x1,75	7,0	110	28	39,50	5	004280112
14x2	9,0	110	30	52,50	5	004280114
16x2	9,0	110	32	62,00	5	004280116
18x2,5	11,0	125	34	83,00	3	004280118
20x2,5	12,0	140	34	89,00	3	004280120
22x2,5	14,5	140	34	108,00	3	004280122
24x3	14,5	160	38	115,00	3	004280124

## 428FC/C7

jogo de  
7 machos  
428FC,  
em HSS



428FC/C7	€ 142,00	1	004280204
428FC M3÷12			
428F/SPV	€ 20,80	1	004280205

## 429FP

machos mecânicos para furos vazantes  
passo largo em HSS-CO 5%



ISO 529

M	mm	L	L1	€		
3x0,5	2,7	56	11	25,00	5	004290003
4x0,7	3,4	63	13	25,00	5	004290004
5x0,8	4,9	70	16	25,00	5	004290005
6x1	4,9	80	19	27,00	5	004290006
8x1,25	6,2	90	22	30,00	5	004290008
10x1,5	8,0	100	24	35,50	5	004290010
12x1,75	7,0	110	28	44,00	5	004290012
14x2	9,0	110	30	59,00	5	004290014

## 429FP/C7

jogo de  
7 machos  
429FP,  
em HSS-CO 5%



429FP/C7	€ 148,00	1	004290203
429FP M3÷12			
428F/SPV	€ 20,80	1	004280205

## 429FC

machos mecânicos para furos cegos  
passo largo em HSS-CO 5%



ISO 529

M	mm	L	L1	€		
3x0,5	2,7	56	11	30,50	5	004290103
4x0,7	3,4	63	13	30,50	5	004290104
5x0,8	4,9	70	16	30,50	5	004290105
6x1	4,9	80	19	32,00	5	004290106
8x1,25	6,3	90	22	36,00	5	004290108
10x1,5	8,0	100	24	43,00	5	004290110
12x1,75	7,0	110	28	52,50	5	004290112
14x2	9,0	110	30	69,00	5	004290114

## 429FC/C7

jogo de  
7 machos  
429FC,  
em HSS-CO 5%



429FC/C7	€ 175,00	1	004290204
429FC M3÷12			
428F/SPV	€ 20,80	1	004280205

## 430

machos manuais, passo largo  
em aço ao crómio

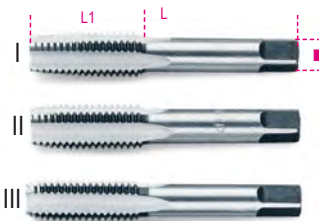

DIN 352 UNI 4535

M	mm	L	L1	€		
2x0,4	2,5	36	11	16,70	5	004300002
3x0,5	2,5	40	12	11,80	5	004300003
4x0,7	3,0	45	14	11,80	5	004300004
5x0,8	4,0	48	16	12,30	5	004300005
6x1	5,0	50	18	12,40	5	004300006
7x1	4,5	50	18	15,90	5	004300007
8x1,25	5,0	56	22	16,00	3	004300008
9x1,25	5,5	63	22	21,60	3	004300009
10x1,5	6,0	70	25	20,50	3	004300010
11x1,5	7,0	70	25	26,50	3	004300011
12x1,75	7,0	75	30	26,50	3	004300012
14x2	8,0	80	32	33,50	3	004300014
16x2	10,0	80	32	39,50	3	004300016
18x2,5	11,0	95	40	52,50	1	004300018
20x2,5	12,0	95	40	63,00	1	004300020
22x2,5	14,5	100	40	76,50	1	004300022
24x3	14,5	110	50	90,50	1	004300024



430/SP21	€ 142,00	1	004300201
M 3-4-5-6-8-10-12			
430/SPV	€ 29,50	1	004300202



## 430ASW

machos manuais rosca Whitworth  
em aço ao cromo



DIN 352

BSW	mm	L	L1	€	🔧	📦
1/8x40	2,7	40	12	11,60	5	004300031
5/32x32	3,4	45	14	11,60	5	004300032
3/16x24	4,3	48	18	11,60	5	004300033
1/4x20	4,9	50	22	13,60	5	004300034
5/16x18	4,9	56	25	16,40	3	004300035
3/8x16	5,5	70	28	21,60	3	004300036
7/16x14	6,2	70	30	24,50	3	004300037
1/2x12	7,0	75	32	27,50	3	004300038
9/16x12	9,0	80	32	33,50	1	004300039
5/8x11	9,0	80	38	40,00	1	004300040
3/4x10	11,0	95	40	58,00	1	004300041
7/8x9	14,5	100	40	72,50	1	004300042
1"x8	16,0	110	50	94,00	1	004300043

## 430ASC

machos manuais rosca UNC  
em aço ao cromo



ANSI B1.1

UNC	mm	L	L1	€	🔧	📦
1/4x20	4,9	70	30	17,30	5	004300051
5/16x18	4,9	70	30	22,30	5	004300052
3/8x16	5,5	75	35	25,00	3	004300053
7/16x14	6,2	80	40	32,50	3	004300054
1/2x13	7,0	85	45	41,00	3	004300055
9/16x12	9,0	90	45	50,50	3	004300056
5/8x11	9,0	100	47	58,00	3	004300057
3/4x10	11,0	110	50	78,00	3	004300058
7/8x9	14,5	120	60	90,00	1	004300059
1"x8	16,0	130	60	102,00	1	004300060

## 431

machos manuais, passo largo em HSS



DIN 352 UNI 4535

M	mm	L	L1	€	🔧	📦
3x0,5	2,5	40	10	22,30	5	004310003
4x0,7	3,3	45	12	22,30	5	004310004
5x0,8	4,2	50	13	22,90	5	004310005
6x1	5,0	56	15	22,90	5	004310006
7x1	6,0	56	16	30,50	5	004310007

M	mm	L	L1	€	🔧	📦
8x1,25	6,8	56	18	28,00	3	004310008
10x1,5	8,5	70	24	34,50	3	004310010
12x1,75	10,2	75	29	52,00	3	004310012
14x2	12,0	80	30	72,50	1	004310014
16x2	14,0	80	32	82,00	1	004310016
18x2,5	15,5	95	40	123,00	1	004310018
20x2,5	17,5	95	40	132,00	1	004310020
22x2,5	19,5	100	40	189,00	1	004310022
24x3	21	110	45	213,00	1	004310024



431/SP21	€	🔧	📦
M 3-4-5-6-8-10-12	258,00	1	004310201
431/SPV	29,50	1	004310202

## 433

machos manuais, passo fino  
em aço ao cromo



DIN 2181 UNI 4535

M	mm	L	L1	€	🔧	📦
6x0,75	4,5	48	16	10,30	5	004330201
7x0,75	4,5	56	18	12,80	5	004330202
8x0,75	5,0	50	16	12,80	5	004330203
8x1	5,0	56	16	12,80	5	004330204
9x0,75	6,0	63	22	16,70	5	004330205
9x1	6,0	63	22	16,70	5	004330206
10x0,75	6,5	63	18	16,70	5	004330207
10x1	6,5	63	18	16,70	5	004330208
10x1,25	6,5	63	18	16,70	5	004330209
11x0,75	7,0	70	25	22,50	3	004330210
11x1	7,0	70	25	22,50	3	004330211
11x1,25	7,0	70	25	22,50	3	004330212
12x0,75	7,0	70	20	21,80	3	004330213
12x1	7,0	70	20	21,80	3	004330214
12x1,25	7,0	70	20	21,80	3	004330215
12x1,5	7,0	70	20	21,80	3	004330216
14x1	8,0	80	32	29,00	1	004330217
14x1,25	8,0	80	32	29,00	1	004330218
14x1,5	8,0	80	32	29,00	1	004330219
16x1	10,0	80	32	34,00	1	004330220
16x1,5	10,0	80	32	34,00	1	004330221
18x1,5	11,0	95	40	40,00	1	004330222
18x2	11,0	80	25	52,00	1	004330223
20x1,5	14,5	80	22	59,00	1	004330224
22x1,5	14,5	80	22	70,50	1	004330225
24x1,5	14,5	80	22	82,00	1	004330226
24x2	14,5	80	22	81,50	1	004330227



## 433ASF

machos manuais, passo fino, rosca UNF  
em aço ao cromo

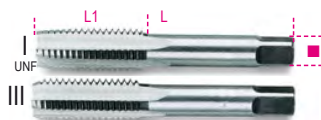

ANSI B1.1

UNF	mm	L	L1	€	🔧	📦
1/4x28	4,9	70	30	13,00	5	004330301
5/16x24	4,9	70	30	15,50	5	004330302
3/8x24	5,5	75	35	17,60	3	004330303
7/16x20	6,2	80	40	22,30	3	004330304
1/2x20	7,0	85	45	28,50	3	004330305
9/16x18	9,0	90	45	35,50	3	004330306
5/8x18	9,0	100	47	40,00	3	004330307
3/4x16	11,0	110	50	54,00	3	004330308
7/8x14	14,5	120	60	70,00	1	004330309
1"x12	16,0	130	60	95,50	1	004330310

## 433ASG

machos manuais rosca GAS cilíndrica  
em aço ao cromo



DIN 5157

GAS	mm	L	L1	€	🔧	📦
1/8x28	5,5	65	18	18,60	1	004330401
1/4x19	9,0	70	24	23,70	1	004330402
3/8x19	9,0	75	25	29,00	1	004330403
1/2x14	12,0	80	31	40,50	1	004330405
3/4x14	16,0	90	33	66,50	1	004330408
1"x11	20,0	100	39	108,00	1	004330410

## 434

machos manuais, passo fino em HSS

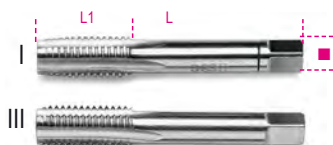

DIN 2181 UNI 4535

M	mm	L	L1	€	🔧	📦
6x0,75	5,2	50	15	29,50	5	004340001
8x0,75	7,2	56	18	34,50	5	004340003
8x1	7,0	56	18	34,50	5	004340004
10x0,75	9,2	63	20	43,00	5	004340007
10x1	9,0	63	18	43,00	5	004340008
10x1,25	8,7	70	24	43,00	5	004340009
12x1	11,0	70	20	46,50	3	004340014
12x1,25	10,7	70	20	46,50	3	004340015
12x1,5	10,5	70	20	46,50	3	004340016
13x1,5	11,5	70	22	97,50	1	004340017
14x1	13,0	70	20	58,00	1	004340018
14x1,25	12,7	70	20	58,00	1	004340019
14x1,5	12,5	70	20	49,50	1	004340020
15x1,5	13,5	70	22	97,50	1	004340021
16x1	15,0	70	20	62,50	1	004340022
16x1,5	14,5	70	20	53,50	1	004340023
18x1,5	16,5	80	22	69,50	1	004340024
18x2	16,0	80	22	84,00	1	004340025
20x1,25	18,8	80	22	119,00	1	004340026
20x1,5	18,5	80	22	74,00	1	004340027
20x2	18,0	80	22	91,50	1	004340028
22x1,5	20,5	80	22	106,00	1	004340029
24x1	23,0	90	22	142,00	1	004340030
24x1,5	22,5	90	22	119,00	1	004340031
24x2	22,0	90	22	125,00	1	004340032

## 435

desandadores de machos extensíveis  
corpo em aço



DIN 1814

	□ mm	L mm	€		
435/0	2÷5 M1÷M8	170	20,00	3	004350007
435/1	2÷6 M1÷M10	200	24,00	2	004350009
435/1,5	2,5÷6 M1÷M12	200	25,50	2	004350011
435/2	3÷7 M4÷M12	260	36,00	2	004350013
435/3	4÷12 M5÷M20	345	60,00	1	004350020
435/4	5,5÷16 M11÷M27	430	93,50	1	004350027
435/5	7÷18 M13÷M32	770	211,00	1	004350032

## 435G

desandadores de machos extensíveis  
corpo em liga leveira



DIN 1814

	□ mm	L mm	€		
435G/0	2÷5 M1÷M8	130	14,20	5	004350108
435G/1	2÷6 M1÷M10	190	17,40	5	004350110
435G/1,5	2÷7 M2÷M12	175	18,10	5	004350112
435G/2	3,4÷7 M4÷M12	280	30,00	5	004350114
435G/3	4,9÷12 M5÷M20	380	48,00	2	004350121
435G/4	7÷16 M11÷M27	500	76,50	2	004350127
435G/5	7÷18 M13÷M32	700	121,00	1	004350132
435G/6	11÷24 M18÷M42	800	199,00	1	004350142

## 436

punhos desandadores de machos  
com roquete reversível

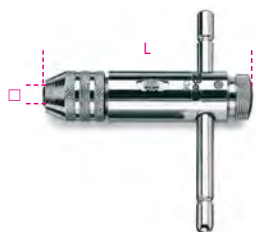

	□ mm	L mm	€		
436/1	2÷5 M3÷M8	85	33,50	5	004360002
436/2	4,6÷8 M5÷M12	110	42,00	5	004360004

## 436L

punhos desandadores de machos  
com roquete reversível, tipo longo



	□ mm	L mm	€		
436L/1	2÷5 M3÷M8	245	52,50	2	004360012
436L/2	4,6÷8 M5÷M12	295	61,50	2	004360014

## 436R

buchas de substituição  
para artigos 436 e 436L

	€		
436R/1	6,20	1	004360022
436R/2	7,00	1	004360024

## 437P

ferramenta para reparação de roscas internas,  
externas, à direita e esquerda danificadas

P 0.80÷3.00 mm



L mm	€		
230	54,00	1	004370003

## 437C

jogo para reparação de roscas de velas de  
ignição, M14x1.25 mm

• Altura helicoidal: 8.40 - 12.40 - 16.40 mm (5 pcs/tamanho)



437C	€		
	141,00	1	004370100

## 437C/...

helicóides em aço inoxidável para ref. 437C



H mm	€		
8.4	36,00	1	004370108
12.4	36,00	1	004370112
16.4	36,00	1	004370116

Os preços indicados são para 10 unidades

## 437C/RM14

macho para velas de ignição M14x1.25



437C/RM14	€		
	117,00	1	004370124

## 437K/9

Jogo de ferramentas para reparação de  
roscas machos e fêmeas dos parafusos de  
rodas

Permite que a rosca original seja reparada e retificada

Componentes do kit:

- Machos:  
M12x1.25 - M12x1.5 - M12x1.75 - M14x1.5
- Caçonetes  
M12x1.25 - M12x1.5 - M14x1.5



∅ 12 - 24 mm

437K/9	€		
	98,00	1	004370029

161x123x50 mm

## 437K/12

Jogo de ferramentas para reparação de veios  
roscados

Permite que a rosca original seja rectificada e preparada

Tamanhos incluídos:

- Sistema métrico:  
M16x1.0 - M16x1.5 - M20x1.0 - M20x1.5 - M22x1.5 - M24x1.5 - M24x2.0 - M27x2.0
- Em polegadas (Inch):  
3/4x16 - 3/4x20 - 13/16x20 - 27/32x20



∅ 32 - 35 mm

437K/12	€		
	117,00	1	004370032

220x118x52 mm



### 437K/33

jogo de ferramentas para reparação de fios de vela danificados

Casquilhos:  
M8x1.0 - M10x1.0 - M10x1.25 - M12x1.25  
Derivações:  
M8x1.0 - M10x1.0 - M10x1.25 - M12x1.0 - M12x1.25 - M14x1.25



437K/33 € 325,00 1 004370133  
210x150x50 mm

### 437U/09

Kit para reparação de roscas danificadas  
M5-M6-M8-M10-M12



25 x M5, M6, M8, M10  
10 x M12

437U/09 € 393,00 1 004370550  
M5X0,8  
M6X1,0  
M8X1,25  
M10X1,5  
M12X1,75  
370x230x55 mm - 2 Kg

### 437U/E-M...

molhas helicoidais em aço inoxidável



M	H mm	€	1	004370555
M5	7,5	21,00	1	004370555
M6	9	21,00	1	004370556
M8	12	29,00	1	004370558
M10	15	38,00	1	004370560
M12	18	23,90	1	004370562

Os preços referem-se a 25 unidades (10 para a medida M12)

### 437U/PM

bits e punções para ref. 437U/09



M	€	1	004370565
M5	39,50	1	004370565
M6	41,00	1	004370566
M8	55,50	1	004370568
M10	72,50	1	004370570
M12	90,50	1	004370572

### 438A

jogo de bits, para perfurar, rosca e escarear, HSS

- M3 - M4 - M5 - M6 - M8 - M10
- Com porta bits magnético



1/4  
S MAX mm = Ø mm

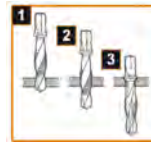

438A € 132,00 1 004380010

### 438...

bits para furar, rosca e escarear

HSS, encabadouro 1/4"

1/4



M	S max mm	€	2	004380103
M3	3	25,50	2	004380103
M4	4	25,50	2	004380104
M5	5	25,50	2	004380105
M6	6	25,50	2	004380106
M8	8	29,00	2	004380108
M10	10	29,00	2	004380110



### 440

caçonetos redondos, passo largo em aço ao cromo

R ≤ 600 N/mm<sup>2</sup>  
HRC || 60+61

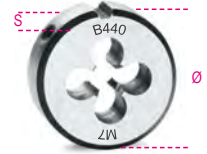

UNI 4535  
DIN 223

M	Ø x S mm	€	5	004400002
2x0,4	25,4 x 9	20,10	5	004400002
3x0,5	25,4 x 9	14,80	5	004400003
4x0,7	25,4 x 9	14,80	5	004400004
5x0,8	25,4 x 9	12,70	5	004400005
6x1	25,4 x 9	12,70	5	004400006
7x1	25,4 x 9	12,70	5	004400007
8x1,25	25,4 x 9	12,70	5	004400008
9x1,25	25,4 x 9	12,70	5	004400009
10x1,5	25,4 x 9	12,70	5	004400010
12x1,75	25,4 x 9	12,70	5	004400012

### 440A

caçonetos redondos, passo largo em aço ao cromo

R ≤ 600 N/mm<sup>2</sup>  
HRC || 60+61

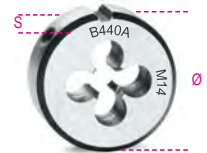

UNI 4535  
DIN 223

M	Ø x S mm	€	3	004400110
10x1,5	38,1 x 14	18,10	3	004400110
11x1,5	38,1 x 14	18,10	3	004400111
12x1,75	38,1 x 14	18,10	3	004400112
14x2	38,1 x 14	18,10	3	004400114
16x2	38,1 x 14	18,10	3	004400116
18x2,5	38,1 x 14	21,10	3	004400118
20x2,5	38,1 x 14	23,30	3	004400120

### 440B

caçonetos redondos, passo largo em aço ao cromo

R ≤ 600 N/mm<sup>2</sup>  
HRC || 60+61



UNI 4535  
DIN 223

M	Ø x S mm	€	3	004400122
18x2,5	50,8 x 16	32,00	3	004400122
20x2,5	50,8 x 16	34,00	3	004400124
22x2,5	50,8 x 16	36,50	3	004400126
24x3	50,8 x 16	37,00	3	004400128



## 440ASW

caçonetos redondos rosca Whitworth  
em aço ao cromo  
R ≤ 600 N/mm<sup>2</sup>



UNI EN 22568  
DIN 223

BSW	Ø x S mm	€	UN	IT
1/8x40	25,4 x 9	17,20	5	004400201
5/32x32	25,4 x 9	17,20	5	004400202
3/16x24	25,4 x 9	15,30	5	004400203
1/4x20	25,4 x 9	15,30	5	004400204
5/16x18	25,4 x 9	15,30	5	004400205
3/8x16	38,1 x 14	21,80	3	004400206
7/16x14	38,1 x 14	21,80	3	004400207
1/2x12	38,1 x 14	22,50	3	004400208
9/16x12	38,1 x 14	22,50	3	004400209
5/8x11	50,8 x 16	39,50	3	004400210
3/4x10	50,8 x 16	39,50	3	004400211
7/8x9	50,8 x 16	45,50	3	004400212
1"x8	50,8 x 16	45,50	3	004400213

## 440ASC

caçonetos redondos passo largo  
rosca UNC em aço ao cromo

R ≤ 600 N/mm<sup>2</sup>



UNI EN 22568  
DIN 223

UNC	Ø x S mm	€	UN	IT
1/4x20	25,4 x 9	15,20	5	004400221
5/16x18	25,4 x 9	15,20	5	004400222
3/8x16	38,1 x 14	21,10	3	004400223
7/16x14	38,1 x 14	21,10	3	004400224
1/2x13	38,1 x 14	21,10	3	004400225
9/16x12	38,1 x 14	21,10	3	004400226
5/8x11	50,8 x 16	44,00	3	004400227
3/4x10	50,8 x 16	44,00	3	004400228
7/8x9	50,8 x 16	44,00	3	004400229
1"x8	50,8 x 16	44,00	3	004400230

## 440ASF

caçonetos redondos passo fino  
rosca UNF em aço ao cromo

UNI EN 2258  
DIN 223

UNF	Ø x S mm	€	UN	IT
1/4x28	25,4 x 9	16,10	5	004400241
5/16x24	25,4 x 9	16,10	5	004400242
3/8x24	38,1 x 14	22,90	3	004400243
7/16x20	38,1 x 14	22,90	3	004400244
1/2x20	38,1 x 14	22,90	3	004400245
9/16x18	38,1 x 14	22,90	3	004400246
5/8x18	50,8 x 16	46,50	3	004400247
3/4x16	50,8 x 16	46,50	3	004400248
7/8x14	50,8 x 16	46,50	3	004400249
1"x12	50,8 x 16	46,50	3	004400250

## 440ASG

caçonetos redondos rosca GAS  
cilíndrica em aço ao cromo

R ≤ 600 N/mm<sup>2</sup>



UNI EN 24231  
DIN 223

GAS	Ø x S mm	€	UN	IT
1/8x28	38,1 x 14	18,10	3	004400255
1/4x19	38,1 x 14	18,10	3	004400256
3/8x19	38,1 x 14	18,10	3	004400257
1/2x14	50,8 x 16	37,00	3	004400259
3/4x14	50,8 x 16	37,00	3	004400260
1"x11	63,5 x 19	72,50	3	004400261

## 441

caçonetos redondos, passo fino  
em aço ao cromo

R ≤ 600 N/mm<sup>2</sup>  
HRC || 60+61

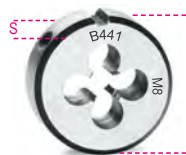

UNI 4535  
DIN 223

M	Ø x S mm	€	UN	IT
6x0,75	25,4 x 9	15,30	5	004410004
7x0,75	25,4 x 9	15,30	5	004410005
8x0,75	25,4 x 9	15,30	5	004410006
8x1	25,4 x 9	15,30	5	004410007
9x0,75	25,4 x 9	15,30	5	004410008
9x1	25,4 x 9	15,30	5	004410009

## 441A

caçonetos redondos, passo fino  
em aço ao cromo

R ≤ 600 N/mm<sup>2</sup>  
HRC || 60+61



UNI 4535  
DIN 223

M	Ø x S mm	€	UN	IT
10x0,75	38,1 x 14	22,90	3	004410100
10x1	38,1 x 14	22,90	3	004410101
10x1,25	38,1 x 14	22,90	3	004410102
11x0,75	38,1 x 14	22,90	3	004410103
11x1	38,1 x 14	22,90	3	004410104
11x1,25	38,1 x 14	22,90	3	004410105
12x0,75	38,1 x 14	22,90	3	004410106
12x1	38,1 x 14	22,90	3	004410107
12x1,25	38,1 x 14	22,90	3	004410108
12x1,5	38,1 x 14	22,90	3	004410109
14x1	38,1 x 14	22,90	3	004410110
14x1,25	38,1 x 14	22,90	3	004410111
14x1,5	38,1 x 14	22,90	3	004410112
16x1	38,1 x 14	22,90	3	004410113
16x1,5	38,1 x 14	22,90	3	004410114
18x1,5	38,1 x 14	22,90	3	004410115

## 441B

caçonetos redondos, passo fino  
em aço ao cromo

R ≤ 600 N/mm<sup>2</sup>  
HRC || 60+61

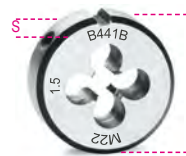

UNI 4535  
DIN 223

M	Ø x S mm	€	UN	IT
18x1,5	50,8 x 16	42,50	3	004410117
18x2	50,8 x 16	42,50	3	004410118
20x1,5	50,8 x 16	43,00	3	004410119
22x1,5	50,8 x 16	45,50	3	004410120
24x1,5	50,8 x 16	46,00	3	004410121
24x2	50,8 x 16	46,00	3	004410122



## 442

caçonetos redondos, **passo largo**  
em HSS

HRC || 62+63  
AISI M2



UNI EN 22568  
DIN 223

M	ØxS mm	€		
3x0,5	20x5	17,80	3	004420003
4x0,7	20x5	17,80	3	004420004
5x0,8	20x7	18,10	3	004420005
6x1	20x7	18,10	3	004420006
7x1	25x9	20,20	3	004420007
8x1,25	25x9	20,20	3	004420008
10x1,5	30x11	22,90	3	004420010
12x1,75	38x14	38,50	3	004420012
14x2	38x14	49,50	1	004420014
16x2	45x18	63,00	1	004420016
18x2,5	45x18	66,50	1	004420018
20x2,5	45x18	66,50	1	004420020

## 443

caçonetos redondos **passo fino**  
rosca **UNF** em aço HSS

HRC || 62+63  
AISI M2



UNI EN 22568  
DIN 223

M	ØxS mm	€		
6x0,75	20x7	30,50	1	004430107
8x0,75	25x9	34,00	1	004430110
8x1	25x9	32,00	1	004430111
10x0,75	30x11	41,50	1	004430113
10x1	30x11	37,00	1	004430114
10x1,25	30x11	37,00	1	004430115
12x1	38x10	60,50	1	004430116
12x1,25	38x10	60,50	1	004430117
12x1,5	38x10	60,50	1	004430118
13x1,5	38x10	72,00	1	004430119
14x1	38x10	60,50	1	004430120
14x1,25	38x10	60,50	1	004430121
14x1,5	38x10	60,50	1	004430122
15x1,5	38x10	81,00	1	004430123
16x1	45x14	89,50	1	004430124
16x1,5	45x14	89,50	1	004430125
18x1,5	45x14	89,50	1	004430127
20x1,25	45x14	92,50	1	004430129
20x1,5	45x14	92,50	1	004430130
20x2	45x14	92,50	1	004430131
22x1,5	55x16	112,00	1	004430132
24x1	55x16	115,00	1	004430133
24x1,5	55x16	115,00	1	004430135
24x2	55x16	122,00	1	004430136

## 444

porta-caçonetos corpo em aço



UNI EN 22568  
DIN 225

	Ø mm	L mm	€		
444	20x5	190	24,10	5	004440005
444/0	20x7	190	24,10	5	004440007
444/1	25,4x9,5	210	25,00	5	004440025
444/1A	25x9	215	26,00	5	004440027
444/1B	30x11	250	30,00	5	004440030
444/C	38x10	310	38,00	3	004440033
444/1C	38x14	310	38,00	3	004440035
444/2	38,1x12,7	300	39,50	3	004440038
444/1D	45x14	445	53,50	1	004440045
444/2D	45x18	445	53,50	1	004440046
444/3	50,8x15,9	520	77,00	1	004440050
444/4	55x16	495	77,00	1	004440055
444/5A	63,5x19	520	133,00	1	004440057

## 444G

porta-caçonetos corpo em liga leveira



UNI EN 22568  
DIN 225

	Ø mm	L mm	€		
444G/A	16x5	160	11,40	5	004440103
444G	20x5	185	13,10	5	004440105
444G/0	20x7	185	13,10	5	004440107
444G/1	25,4x9,5	215	16,00	5	004440125
444G/1A	25x9	215	16,00	5	004440127
444G/1B	30x11	265	20,50	5	004440130
444G/C	38x10	315	30,00	3	004440133
444G/1C	38x14	315	30,00	3	004440135
444G/2	38,1x12,6	310	30,00	3	004440138
444G/1D	45x14	450	39,50	1	004440145
444G/2D	45x18	450	40,50	1	004440146
444G/3	50,8x16	485	42,00	1	004440150
444G/4	55x16	560	51,00	1	004440155
444G/5A	63,5x19	630	89,50	1	004440163
444G/6	65x18	630	95,00	1	004440165



## 446/C30

jogo de machos e caçonetos  
em aço ao cromo e acessórios  
rosca métrica em caixa de madeira



446/C30 € 368,00 1 004460055  
325x220x35 mm - 3,2 Kg

430 M mm	440 M mm		
3x0,5	3x0,5	435/1,5	444/1
4x0,7	4x0,7		
5x0,8	5x0,8		
6x1	6x1		
8x1,25	8x1,25		
10x1,5	10x1,5		
12x1,75	12x1,75		

## 446/C48

jogo de machos e caçonetos  
em aço ao cromo e acessórios  
rosca métrica em caixa de madeira



446/C48 € 700,00 1 004460057  
580x300x50 mm - 5 Kg

430 M mm	440 M mm	440A M mm		
3x0,5	3x0,5	10x1,5	435/1	444/1
4x0,7	4x0,7	12x1,75	435/3	444/2
5x0,8	5x0,8	14x2		
6x1	6x1	16x2		
8x1,25	8x1,25	18x2,5		
10x1,5		20x2,5		
12x1,75				
14x2				
16x2				
18x2,5				
20x2,5				



## 446/C110

jogo de machos e caçonetos em aço ao cromo e acessórios rosca métrica em caixa de madeira



446/C110 € 1.010,00 1 004460060

500x337x60 mm - 8,1 Kg

430	433	440/440A	441/441A
M mm	M mm	M mm	M mm
2x0,4	6x0,75	2x0,4	6x0,75
3x0,5	7x0,75	3x0,5	7x0,75
4x0,7	8x0,75	4x0,7	8x0,75
5x0,8	8x1	5x0,8	8x1
6x1	9x0,75	6x1	9x0,75
7x1	9x1	7x1	9x1
8x1,25	10x0,75	8x1,25	10x0,75
9x1,25	10x1	9x1,25	10x1
10x1,5	10x1,25	10x1,5	10x1,25
11x1,5	11x0,75	11x1,5	11x0,75
12x1,75	11x1	12x1,75	11x1
14x2	11x1,25	14x2	11x1,25
16x2	12x0,75	16x2	12x0,75
	12x1		12x1
	12x1,25		12x1,25
	12x1,5		12x1,5
	14x1		14x1
	14x1,25		14x1,25
	14x1,5		14x1,5
	16x1		16x1
	16x1,5		16x1,5
	18x1,5		18x1,5

435/0	444/1	436/1
435/3	444/2	

## 446ASF/C29

jogo de machos e caçonetos em aço ao cromo e acessórios rosca UNF em caixa de madeira



446ASF/C29 € 800,00 1 004460070

660x410x50 mm - 6 Kg

433ASF	440ASF		
1/4	1/4	435/1,5	444/1
5/16	5/16	435/3	444/2
3/8	3/8		444/3
7/16	7/16		
1/2	1/2		
9/16	9/16		
5/8	5/8		
3/4	3/4		

## 446ASC/C37

jogo de machos e caçonetos em aço ao cromo e acessórios rosca UNC em caixa de madeira



446ASC/C37 € 855,00 1 004460080

660x410x50 mm - 6,7 Kg

430ASC	440ASC		
1/4	1/4	435/1,5	444/1
5/16	5/16	435/3	444/2
3/8	3/8		444/3
7/16	7/16		
1/2	1/2		
9/16	9/16		
5/8	5/8		
3/4	3/4		

## 446ASW/C36

jogo de machos e caçonetos em aço ao cromo e acessórios rosca Whitworth em caixa de madeira



446ASW/C36 € 590,00 1 004460075

525x310x50 mm - 3,4 Kg

430ASW	440ASW		
1/8	1/8	435/1,5	444/1
5/32	5/32	435/2	444/2
3/16	3/16		
1/4	1/4		
5/16	5/16		
3/8	3/8		
7/16	7/16		
1/2	1/2		

## 446ASG/C23

jogo de machos e caçonetos em aço ao cromo e acessórios rosca GAS cilíndrica em caixa de madeira



446ASG/C23 € 1.250,00 1 004460085

700x430x70 mm - 9,8 Kg

433ASG	440ASG		
1/8	1/8	435/3	444/2
1/4	1/4	435/5	444/3
3/8	3/8		444/5A
1/2	1/2		
3/4	3/4		
1"	1"		





## 447/C37

jogo de machos e caçonetos em HSS e acessórios  
rosca métrica em caixa de metálica



447/C37 € 745,00 1 004470055

≡ 380x185x35 mm - 3,9 Kg

431 M mm	442 M mm		
3x0,5	3x0,5	435/0	444
4x0,7	4x0,7	435/2	444/0
5x0,8	5x0,8		444/1A
6x1	6x1		444/1B
8x1,25	8x1,25		444/1C
10x1,5	10x1,5		
12x1,75	12x1,75		

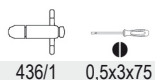

436/1 0,5x3x75

## 447/C53

jogo de machos e caçonetos em HSS e acessórios  
rosca métrica em caixa de metálica



447/C53 € 1.550,00 1 004470060

≡ 500x235x50 mm - 9 Kg

431 M mm	442 M mm			
3x0,5	3x0,5	435/1,5	444	436/1
4x0,7	4x0,7	435/3	444/0	436/2
5x0,8	5x0,8		444/1A	
6x1	6x1		444/1B	
8x1,25	8x1,25		444/1C	
10x1,5	10x1,5		444/2D	
12x1,75	12x1,75			
14x2	14x2			
16x2	16x2			
18x2,5	18x2,5			
20x2,5	20x2,5			

## 447/C70

jogo de machos e caçonetos em HSS e acessórios  
rosca métrica em caixa de madeira



447/C70 € 1.950,00 1 004470065

≡ 510x340x70 mm - 7,5 Kg

431 M mm	434 M mm	442 M mm	443 M mm
3x0,5	8x1	3x0,5	8x1
4x0,7	10x1,25	4x0,7	10x1,25
5x0,8	12x1,25	5x0,8	12x1,25
6x1	12x1,5	6x1	12x1,5
7x1	14x1,25	7x1	14x1,25
8x1,25	14x1,5	8x1,25	14x1,5
10x1,5	16x1,5	10x1,5	16x1,5
12x1,75		12x1,75	
14x2		14x2	
16x2		16x2	

435/0	444	436/1
435/3	444/0	
	444/1A	
	444/1B	
	444/C	
	444/1C	
	444/1D	
	444/2D	

## 450

brocas craneanas, bimetel,  
HSS-Co 8%

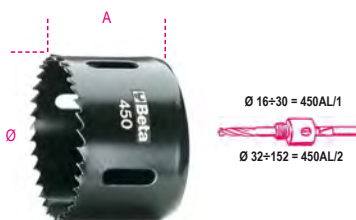

HSS-Co 8%

Ø mm	Ø	A mm	€		
16	(5/8)	57	19,70	1	004500016
17	(11/16)	57	19,70	1	004500017
19	(3/4)	51	19,70	1	004500019
20	-	51	19,70	1	004500020
21	(13/16)	51	19,70	1	004500021
22	(7/8)	51	19,70	1	004500022
24	(15/16)	51	19,70	1	004500024
25	(1")	51	21,60	1	004500025
27	(1"1/16)	51	22,40	1	004500027
29	(1"1/8)	51	22,40	1	004500029
30	(1"3/16)	51	22,40	1	004500030
32	(1"1/4)	51	22,40	1	004500032

Ø mm	Ø	A mm	€		
33	(1"5/16)	51	22,90	1	004500033
35	(1"3/8)	51	26,00	1	004500035
37	(1"7/16)	51	26,00	1	004500037
38	(1"1/2)	44	26,50	1	004500038
40	(1"9/16)	44	27,50	1	004500040
41	(1"5/8)	44	28,00	1	004500041
43	(1"11/16)	44	28,00	1	004500043
44	(1"3/4)	44	29,00	1	004500044
46	(1"13/16)	44	29,00	1	004500046
48	(1"7/8)	44	29,50	1	004500048
51	(2")	44	30,50	1	004500051
52	(2"1/16)	44	34,50	1	004500052
54	(2"1/8)	44	34,50	1	004500054
57	(2"1/4)	44	34,50	1	004500057
59	(2"5/16)	44	36,00	1	004500059
60	(2"3/8)	44	36,00	1	004500060
64	(2"1/2)	44	37,50	1	004500064
65	(2"9/16)	44	37,50	1	004500065
67	(2"5/8)	44	37,50	1	004500067
68	-	44	37,50	1	004500068
70	(2"3/4)	44	38,50	1	004500070
73	(2"7/8)	44	38,50	1	004500073
76	(3")	44	40,00	1	004500076
79	(3"1/8)	44	42,00	1	004500079
83	(3"1/4)	44	43,50	1	004500083
86	(3"3/8)	44	43,50	1	004500086
89	(3"1/2)	44	46,00	1	004500089
92	(3"5/8)	44	48,50	1	004500092
95	(3"3/4)	44	51,00	1	004500095
98	(3"7/8)	44	52,00	1	004500098
102	(4")	44	54,00	1	004500102
105	(4"1/8)	44	59,00	1	004500105
108	(4"1/4)	44	73,50	1	004500108
111	(4"3/8)	44	83,50	1	004500111
114	(4"1/2)	44	98,50	1	004500114
121	(4"3/4)	44	110,00	1	004500121
127	(5")	44	120,00	1	004500127
140	(5"1/2)	44	147,00	1	004500140
152	(6")	44	170,00	1	004500152

## 450AL

buchas para brocas craneanas



	Ø mm	L mm	€		
450AL/1	16÷30	54	24,00	1	004500210
450AL/2	32÷152	70	56,00	1	004500215

## 450AD

adaptador bucha/broca craneana 450AL/1



	Ø mm	€		
450AD	32÷51	9,50	1	004500230



## 450PA/1

brocas para buchas em HSS para 450AL/1

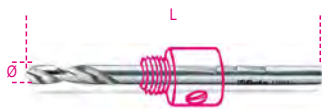

ØxL mm	€	1	004500252
6,35x105	14,90		

## 450PA/2

brocas para buchas em HSS para 450AL/2

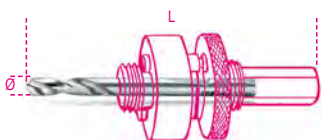

ØxL mm	€	1	004500253
6,35x80	14,90		

## 450PR

extensão para brocas cranianas



L mm	€	1	004500255
305	40,50		

## 450/C9

jogo de brocas cranianas e acessórios para electricista



HSS-Co 8%

450/C9	€	1	004500305
	285,00		

450	Ø 22 - 29 - 35 - 44 - 51 - 64 mm
450AL	/1 - /2
450AD	220x160x60 mm - 1,6 Kg

## 450/C13

jogo de brocas cranianas e acessórios para instaladores



HSS-Co 8%

450/C13	€	1	004500310
	357,00		

450	Ø 19 - 22 - 29 - 35 - 38 44 - 51 - 57 - 64 mm
450AL	/1 - /2
450PA/1	
450AD	215x180x65 mm - 1,8 Kg

## 450/C15

Sortido de serras e acessórios para eléctricos



HSS-Co 8%

450/C15	€	1	004500313
	466,00		

450	Ø 16 - 20 - 25 - 32 - 40 51 - 60 - 65 - 70 mm
450AL	/1 - /2
450PA	/1 - /2
450PR	
450AD	420x185x60 mm - 3,2 Kg

## 450/C21

jogo de brocas cranianas e acessórios para uso industrial



HSS-Co 8%

450/C21	€	1	004500315
	815,00		

450	Ø 19 - 22 - 29 - 35 - 38 44 - 51 - 57 - 64 - 76 83 - 92 - 95 - 105 - 114 mm
450AL	/1 - /2
450PA	/1 - /2
450PR	
450AD	420x280x60 mm - 7 Kg

## 451

fresa craniana em HSS inteiramente rectificado

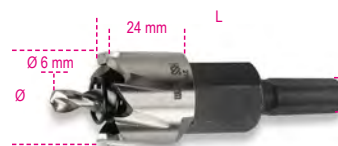

Ø mm	L mm	D mm	€	1	004510012
12	85	8	29,50		
13	85	8	29,50		
14	85	8	30,00		
15	85	10	30,00		
16	85	10	30,00		
17	85	10	30,00		
18	85	10	30,00		
19	85	10	30,50		
20	85	10	32,00		
21	85	10	35,00		
22	85	10	36,50		
23	85	10	38,00		
24	85	10	39,50		
25	85	10	40,50		
26	90	10	42,50		
27	90	10	43,50		
28	90	10	44,50		
29	90	10	46,50		
30	90	10	47,00		
31	90	10	49,50		
32	90	10	51,00		
33	90	10	52,50		
34	90	10	54,00		
35	90	10	56,00		
36	85	10	58,00		
37	85	10	59,00		
38	85	10	60,00		
39	85	10	62,00		
40	85	10	63,00		
41	85	10	64,50		
42	85	10	68,00		
43	85	10	70,00		
44	85	10	71,00		
45	85	10	72,50		
46	85	10	72,50		
47	85	10	75,00		
48	85	10	78,50		
49	85	10	81,00		
50	85	10	81,00		



## 451/C

jogo de 8 fresas craneanas, HSS, inteiramente retificadas



451/C8	€ 379,00	1	004510308
Ø 16-18-20-22-25-30-32-35 mm			
270x225x70 mm			

## 451GA

bucha para fresa craneana artigo 451



M	Ø	L	D	€		
mm	mm	mm	mm			
10x1,25	12÷14	57	8	16,80	1	004510101
12x1,25	15÷34	57	10	16,80	1	004510102
14x1,5	35÷50	57	10	20,50	1	004510105

## 451PA

brocas para buchas 451 em HSS



Ø	L	€		
mm	mm			
6	53	9,50	1	004510103

## 451PR

extensão para fresa craneana artigo 451



M	Ø	L	Ø1	€		
mm	mm	mm	mm			
12x1,25	15÷34	400	13	73,50	1	004510104
14x1,5	35÷50	400	13	73,50	1	004510108



## 452

fresa craneana com insertos em metal duro

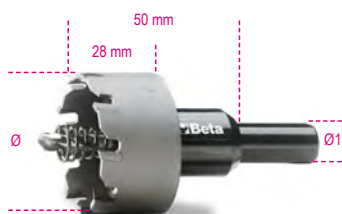

Ø	Ø1	€		
mm	mm			
15	10	121,00	1	004520015
16	10	121,00	1	004520016
17	10	121,00	1	004520017
18	10	121,00	1	004520018
19	10	121,00	1	004520019
20	10	121,00	1	004520020
21	10	121,00	1	004520021
22	10	121,00	1	004520022
23	10	121,00	1	004520023
24	10	121,00	1	004520024
25	10	121,00	1	004520025
26	10	136,00	1	004520026
27	10	136,00	1	004520027
28	10	136,00	1	004520028
29	10	136,00	1	004520029
30	10	136,00	1	004520030
31	10	164,00	1	004520031
32	10	164,00	1	004520032
33	10	164,00	1	004520033
34	10	164,00	1	004520034
35	10	164,00	1	004520035
36	10	190,00	1	004520036
37	10	190,00	1	004520037
38	10	190,00	1	004520038
39	13	190,00	1	004520039
40	13	190,00	1	004520040
41	13	215,00	1	004520041
42	13	215,00	1	004520042
43	13	215,00	1	004520043
44	13	215,00	1	004520044
45	13	215,00	1	004520045
46	13	241,00	1	004520046
47	13	241,00	1	004520047
48	13	241,00	1	004520048
49	13	241,00	1	004520049
50	13	241,00	1	004520050
55	13	274,00	1	004520055
60	13	363,00	1	004520060
65	13	363,00	1	004520065
70	13	423,00	1	004520070
75	13	462,00	1	004520075
80	13	505,00	1	004520080
85	13	565,00	1	004520085
90	13	600,00	1	004520090

## 452GA

bucha para fresa craneana 452



	Ø	€		
	mm			
452GA/1	15÷21	15,00	1	004520125
452GA/2	22÷38	17,50	1	004520126
452GA/3	39÷100	20,90	1	004520127

## 460

fresa craneana para materiais de construção

- Para betão, cimento, pedra natural e artificial
- Profundidade máxima de perfuração: 60 mm

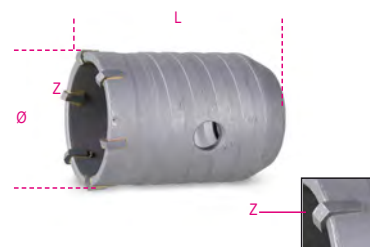

Ø	L	Z	€		
mm	mm				
50	75	6	62,00	1	004600050
60	75	6	73,50	1	004600060
65	75	6	76,50	1	004600065
80	75	6	114,00	1	004600080
90	75	6	120,00	1	004600090
100	75	8	148,00	1	004600100
112	75	8	169,00	1	004600112
125	80	10	210,00	1	004600125
150	80	12	283,00	1	004600150

## 460PP

broca piloto para fresa craneana para materiais de construção (referência 460)



Ø	L	€		
mm	mm			
8	120	7,00	1	004600201

## 460G

adaptador para fresa craneana (referência 460)



L	€		
mm			
220	38,00	1	004600222
370	53,00	1	004600237
460	84,00	1	004600246





# MULTIPLICADORES DE BINÁRIO

Os multiplicadores de binário são ferramentas essenciais para o aperto de porcas e parafusos, uma vez que permitem um binário superior ao que o operador conseguiria aplicar em espaços confinados ou de difícil acesso. Não necessitam de extensões volumosas, garantindo total segurança. A gama de multiplicadores de binário Beta proporciona uma variedade de soluções e capacidades **até 9500 Nm**, e rácios de multiplicação de binário até 125:1. Muitos modelos, particularmente os mais potentes, estão equipados com sistema antirretorno de duplo sentido, para prevenir retornos de tensão perigosos para o operador. Cada multiplicador de binário Beta é acompanhado de um certificado de teste que comprova que a ferramenta foi testada ao valor máximo sob ótimas condições de trabalho.



## Instruções de utilização

O multiplicador de binário deve ser usado com uma chave dinamométrica para assegurar o controlo do binário de saída; adicionalmente, deve ser sempre utilizado com chaves de impacto.

Os rácios de cada multiplicador de binário determinam o **fator de multiplicação** entre o binário de entrada e o de saída. Exemplo: multiplicador de binário com rácio de 5:1. Aplicando um binário de entrada de 100 Nm, conforme programado na chave dinamométrica, resultará num binário de saída de 500 Nm para a porca ou parafuso.

Contudo, assegure-se de que todos os componentes envolvidos no aperto estão corretamente alinhados.

Evite a utilização de **extensões**. Estas girariam, produzindo assim um efeito de mola que iria modificar os valores de binário aplicados.

Garanta sempre que o **braço de reação** do multiplicador de binário está fixo ou apoiado numa estrutura robusta, capaz de suportar a força de reação. Por norma recorre-se a paredes rígidas ou parafusos próximos do que vai ser objeto de aperto. O braço de reação roda sempre na direção oposta à direção de aperto.



Realize a operação de forma suave e ininterrupta.

A tensão de aperto deve ser aliviada rodando o multiplicador de binário noutra direção, ou seja, desengatando-o; se o multiplicador possuir o sistema antirretorno, a tensão de aperto deve ser aliviada através da alavanca de inversão.

As instruções acima também se aplicam a operações de **desaperto**.

## 560/C3

multiplicador de binário para aperto à direita e esquerda, em estojo de plástico relação 3.8:1

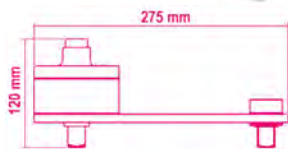

Nm	kgfm	lbf.ft	□	■	kg
1500	150	1110	1/2"	3/4"	3,9

		€	🔧	📦
<b>560/C3</b>		995,00	1	005600030
☞ 400x260x110 mm				

## 560/C2

multiplicador de binário para aperto à esquerda e à direita, com acessórios relação 5:1 em caixa plástica para utilização intensiva



Nm	Kgfm	lbf.ft	□	■	kg
1300	130	960	1/2"	3/4"	3,8

		€	🔧	📦
<b>560/C2</b>		2.020,00	1	005600020
<b>560/2</b>		1.500,00	1	005600002
<b>560/18</b>		47,50	1	005600018
<b>560/19</b>		101,00	1	005600019
<b>560/22</b>		348,00	1	005600022
☞ 310x275x120 mm				

## 560/C6

Multiplicador de binário para aperto a esquerda e a direita em caixa plástica Relação: 6.5:1



Nm	kgfm	lbf.ft	□	■	kg
1500	150	1106	1/2"	3/4"	6

		€	🔧	📦
<b>560/C6</b>		1.040,00	1	005600160
☞ 400x260x110 mm				

## 560/C12

Multiplicador de binário para aperto a esquerda e a direita em caixa plástica Relação: 12:1



Nm	kgfm	lbf.ft	□	■	kg
2500	250	1844	1/2"	1"	7

		€	🔧	📦
<b>560/C12</b>		1.490,00	1	005600210
☞ 400x260x110 mm				

## 560/C3PLUS

multiplicador de binário para aperto à direita e esquerda, em estojo de plástico relação 3.8:1

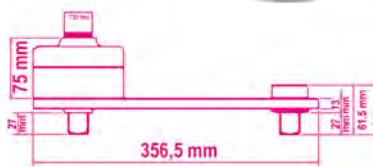

Nm	kgfm	lbf.ft	□	■	kg
2700	270	1991	3/4"	1"	7,5

		€	🔧	📦
<b>560/C3PLUS</b>		1.160,00	1	005600038
☞ 470x240x160 mm				

## 560/C4+

multiplicador de binário para aperto à esquerda e à direita, com acessórios relação 5:1, com sistema antirretorno para utilização intensiva



Nm	Kgfm	lbf.ft	□	■	kg
2700	270	2000	3/4"	1"	5

		€	🔧	📦
<b>560/C4PLUS</b>		1.980,00	1	005600042
<b>560/4</b>		1.570,00	1	005600004
<b>560/18</b>		47,50	1	005600018
<b>560/22</b>		348,00	1	005600022
☞ 310x275x120 mm				

## 561/1

multiplicador de binário, relação 5:1 com duas uniões de reação

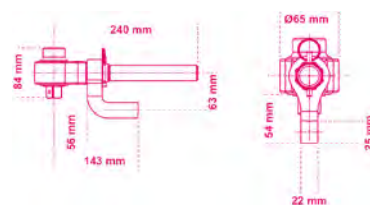

Nm	kgfm	lbf.ft	□	■	kg
1000	100	740	1/2"	3/4"	2,7

		€	🔧	📦
<b>561/1</b>		1.450,00	1	005610010
☞ 270x210x70 mm				

## 562-1/VA - 562-2/VA

multiplicadores de binário para aperto à esquerda e à direita  
relação 5.2:1  
em estojo 562VV-A



Nm	Kgfm	lbf.ft	□	■	D	A	L min	L max	h
1700	170	1250	3/4	1"	mm	mm	mm	mm	kg
					108	95	85	220	8,8

562-1/VA € 3.210,00 1 005620601

Nm	Kgfm	lbf.ft	□	■	D	A	L min	L max	h
3400	340	2500	3/4	1"	mm	mm	mm	mm	kg
					119	115	85	265	10,5

562-2/VA € 3.890,00 1 005620602

## 564-3R/V - 564-4R/V

multiplicadores de binário para aperto à esquerda e à direita

rácio 25:1  
com sistema anti-retorno,  
em estojo



Nm	Kgfm	lbf.ft	□	■	D	A	L	h
4000	400	3000	1/2	1"	mm	mm	mm	kg
					92	185	205	7,6

564-3R/V € 6.250,00 1 005640613

390x310x145 mm

Nm	Kgfm	lbf.ft	□	■	D	A	L	h
7000	700	5000	1/2	1 1/2"	mm	mm	mm	kg
					120	200	210	13,2

564-4R/V € 7.400,00 1 005640614

500x435x170 mm

## 565-1R/VA - 565-2R/VA - 565-3R/VA

multiplicadores de binário para aperto à esquerda e à direita  
relação 27:1  
com sistema anti-retorno,  
em estojo 562VV-A



Nm	Kgfm	lbf.ft	□	■	D	A	L min	L max	h
1700	170	1250	1/2	1"	mm	mm	mm	mm	kg
					108	125	80	215	11,2

565-1R/VA € 5.200,00 1 005650611

Nm	Kgfm	lbf.ft	□	■	D	A	L min	L max	h
3400	340	2500	1/2	1"	mm	mm	mm	mm	kg
					119	145	85	265	13,6

565-2R/VA € 6.800,00 1 005650612

Nm	Kgfm	lbf.ft	□	■	D	A	L min	L max	h
3400	340	2500	1/2	1 1/2"	mm	mm	mm	mm	kg
					119	145	85	265	14,2

565-3R/VA € 7.200,00 1 005650613

## 565-4R/VB

multiplicadores de binário para aperto à esquerda e à direita  
relação 27:1  
com sistema anti-retorno,  
em estojo 565VV-B



Nm	Kgfm	lbf.ft	□	■	D	A	L min	L max	h
6000	600	4500	1/2	1 1/2"	mm	mm	mm	mm	kg
					144	180	125	335	22,4

565-4R/VB € 8.100,00 1 005650614

## 565-5R/VB

multiplicadores de binário para aperto à esquerda e à direita  
relação 27:1  
com sistema anti-retorno,  
em estojo 565VV-B



Nm	Kgfm	lbf.ft	□	■	D	A	L min	L max	h
9500	950	7000	3/4	1 1/2"	mm	mm	mm	mm	kg
					184	180	155	355	30,4

565-5R/VB € 13.800,00 1 005650615

## 567-4R/VB

multiplicadores de binário para aperto à esquerda e à direita  
relação 135:1  
com sistema anti-retorno,  
em estojo 565VV-B

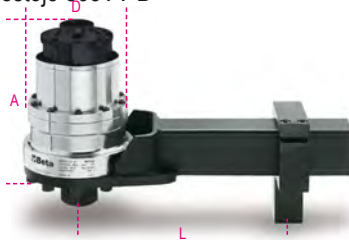

Nm	Kgfm	lbf.ft	□	■	D	A	L min	L max	h
6000	600	4500	1/2	1 1/2"	mm	mm	mm	mm	kg
					144	210	125	335	24,4

567-4R/VB € 9.000,00 1 005670614

## 567-5R/VB

multiplicadores de binário para aperto à esquerda e à direita  
relação 135:1  
com sistema anti-retorno,  
em estojo 565VV-B

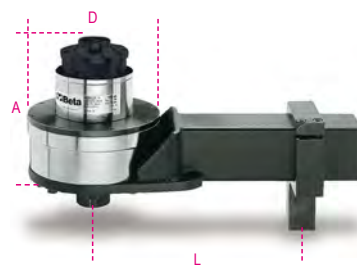

Nm	Kgfm	lbf.ft	□	■	D	A	L min	L max	h
9500	950	7000	1/2	1 1/2"	mm	mm	mm	mm	kg
					184	210	155	350	32,4

567-5R/VB € 15.500,00 1 005670615

## 562VV-A

caixa para multiplicador binário, em polipropileno resistente com revestimento interior em esponja  
Dimensão do interior: 380x270x180 mm



562VV-A € 275,00 1 005620501

562/1-562/2-564/3R  
564/4R-565/1R-565/2R  
565/3R

410x340x205 mm - h 3,5 kg

## 565VV-B

caixa para multiplicador binário, em polipropileno resistente com revestimento interior em esponja  
dimensão do interior: 480x370x205 mm



565VV-B € 371,00 1 005650502

565/4R-565/5R  
567/4R-567/5R

520x435x230 mm - h 5,4 kg





# GUIA PARA CHAVES DINAMOMÉTRICAS



As chaves dinamométricas devem ser sempre manuseadas de forma suave e ininterrupta, evitando movimentos bruscos e agarrando no meio do punho, de forma a não alterar o rácio da alavanca.

A escala de ajuste deve ser reposta a zero após a utilização para não afetar a precisão do aperto. Este procedimento não é necessário com as chaves Zero-Reset.

A Beta oferece uma ampla gama de chaves, com **quatro tipos de funcionamento distintos**.

## MODELOS COM LEITURA DIRETA

A força de binário aplicada é diretamente transmitida para o índice de leitura através de compressão de uma mola helicoidal. O binário aplicado pode ser lido em tempo real através de um ponteiro. Um segundo ponteiro pode ser posicionado no valor de binário desejado. Quando esse valor é alcançado, o segundo ponteiro será imobilizado pelo ponteiro principal e é registado o valor máximo. As chaves dinamométricas de leitura direta asseguram uma precisão e durabilidade notáveis.

## MODELOS COM DESARME SONORO

As chaves dinamométricas com desarme sonoro são as mais populares graças à sua facilidade de utilização. Permitem uma pré-seleção rápida através da mola e o valor do binário aumenta à medida que a força aplicada é ampliada. Quando o valor de binário desejado é alcançado, ocorre um desengate súbito e a chave não aplicará qualquer força por aproximadamente 3-5°. Se o operador não interromper o movimento, o aperto continuará a aumentar, excedendo assim os valores desejados.

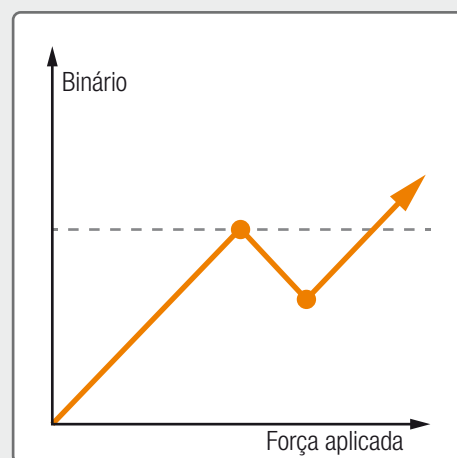
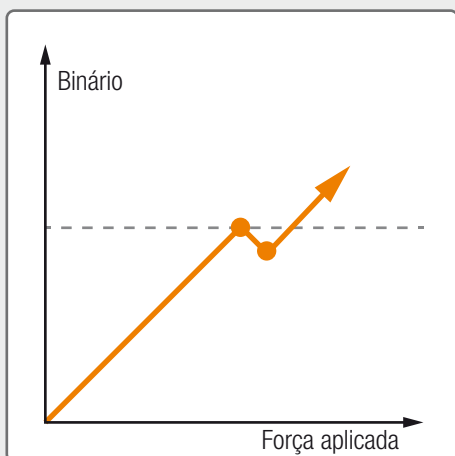

## MODELOS COM EMBRAIAGEM

O funcionamento das chaves dinamométricas com embraiagem é idêntico ao das chaves com desarme sonoro, mas quando o valor de binário é alcançado, ocorre um desengate súbito do braço da alavanca (aprox. 20°). Assim, é mais fácil para o operador interromper a aplicação de força. Normalmente estas chaves são utilizadas para elevados valores de aperto com braços de alavanca muito longos.

## MODELOS COM EMBRAIAGEM DE SEGURANÇA

Quando é alcançado o valor de binário pré-estabelecido, o mecanismo de segurança impede a aplicação do aperto, provocando a imobilização da ferramenta. Isto evitará o aperto com valores acima dos desejados. A manutenção da força resultará na repetição do mesmo ciclo. Estas chaves são ideais para operações sequenciais com baixos valores de aperto (indústria eletrónica e micromecânica), em que é absolutamente prioritário evitar a quebra de componentes delicados ou de pequenas dimensões.

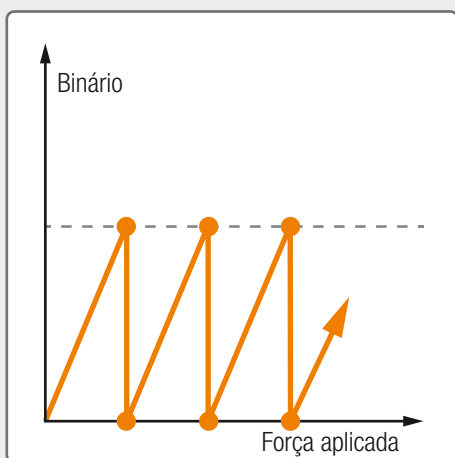

# ÁREAS DE APLICAÇÃO DE CHAVES E BARRAS DINAMOMÉTRICAS

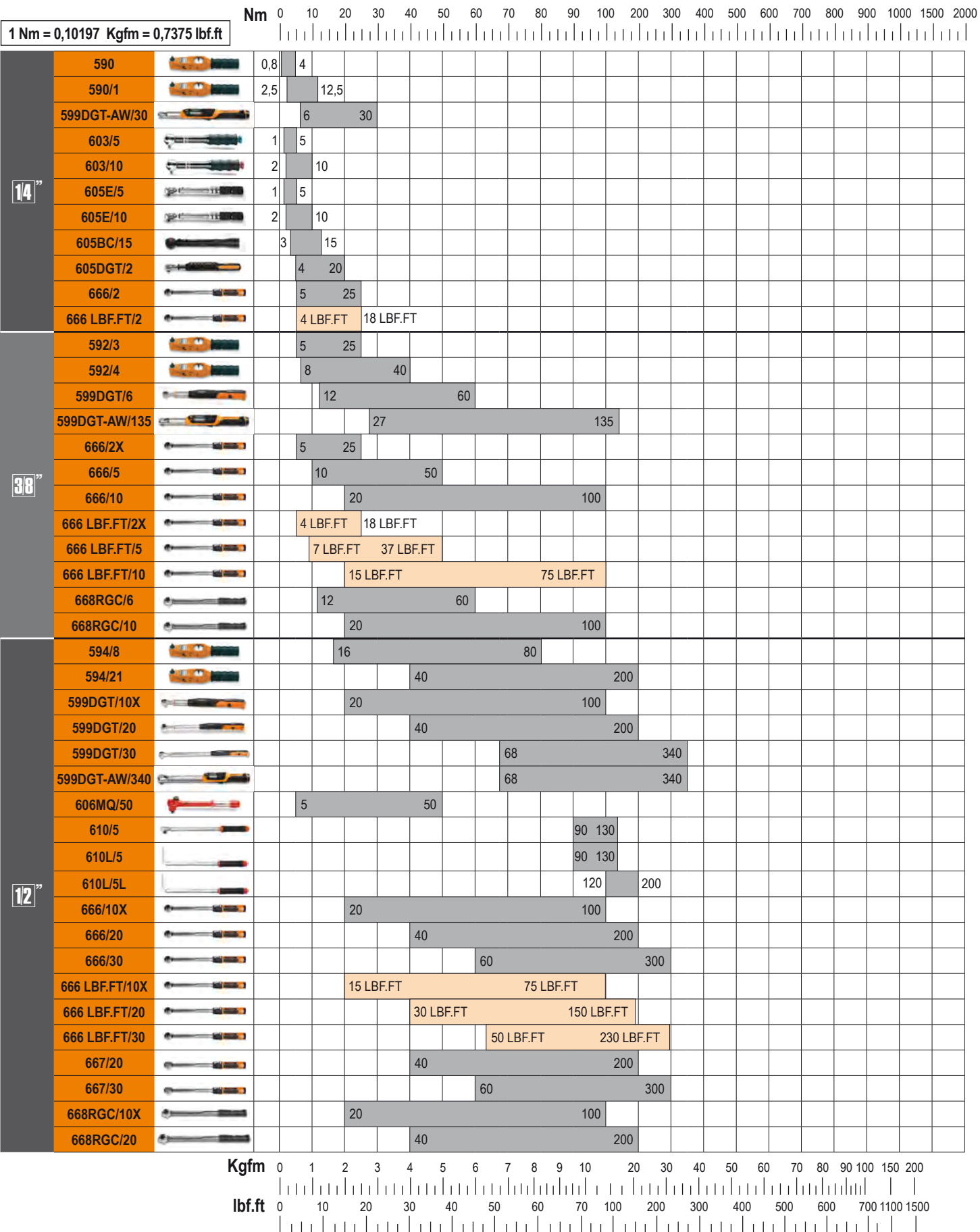





# Beta

## 581

aparafusadora dinâmometrica não graduada para apertos à direita  
precisão: ±6%  
(para utilização com artigos 588 - 682)



UNI EN ISO 6789

Nm	gfm	lbf.in	g
1,2÷6	120÷600	1/4"	275

581 324,00 1 005810001

## 583

aparafusadora dinâmometrica graduada para apertos à direita  
precisão: ±6%



UNI EN ISO 6789

Nm	gfm	lbf.in	g	kg
0,3÷1,5	30÷150	1/4"	240	0,05

583/1,5 365,00 1 005830015

Nm	gfm	lbf.in	g	kg
0,6÷3	60÷300	1/4"	240	0,1

583/3 365,00 1 005830030

Nm	gfm	lbf.in	g	kg
1,2÷6	120÷600	1/4"	350	0,2

583/6 365,00 1 005830060

## 583/C31

1 aparafusadora dinâmometrica, 8 chaves de caixa manuais sextavadas, 20 bits e 2 acessórios

1/4"



583/C31 482,00 1 005830931

	583/6	1.2 - 6 Nm
	900	4.5-5.5-6-7-8-9-10 mm
	860LP	0,6x4,5 - 1x5,5 - 1,2x6,5 mm
	860PH	PH1 - PH2 (x2) - PH3
	860PE	2-2,5-3-4-5 mm
	860TX	T9-T10-T15-T20-T25-T27-T30-T40
	882P/80	80 mm
	892/0	● 1/4" ■ 1/4"

270x120x45 mm - 1,2 kg

## 590 - 592

chaves dinâmometricas de leitura directa para aperto direito e esquerdo  
precisão: ±4%



UNI EN ISO 6789

Nm	Kgfm	lbf.in	lbf.ft	A mm	L mm	kg	kg
0,8÷4	0,08÷0,4	7÷35	1/4	60	253	0,52	0,1

590 860,00 1 005900001

Nm	Kgfm	lbf.in	lbf.ft	A mm	L mm	kg	kg
2,5÷12,5	0,25÷1,25	21÷110	1/4	60	253	0,52	0,5

590/1 860,00 1 005900003

Nm	Kgfm	lbf.in	lbf.ft	A mm	L mm	kg	kg
1÷27	0,1÷2,7	10÷240	3/8	70	253	0,52	1,0

592/3 855,00 1 005920005

Nm	Kgfm	lbf.in	lbf.ft	A mm	L mm	kg	kg
3÷40	0,3÷4	20÷360	3/8	70	253	0,52	1,0

592/4 855,00 1 005920007

## 594

chaves dinâmometricas de leitura directa para aperto direito e esquerdo  
precisão: ±4%

12"



UNI EN ISO 6789

Nm	Kgfm	lbf.ft	lbf.in	A mm	L mm	kg	kg
16÷80	1,6÷8	12÷60	1/2	85	455	1,35	2,0

594/8 1.300,00 1 005940011

Nm	Kgfm	lbf.ft	lbf.in	A mm	L mm	kg	kg
40÷200	4÷20	30÷160	1/2	85	530	1,40	5,0

594/21 1.300,00 1 005940015

Serviço de calibração de binário no final

## 596

chaves dinâmometricas de leitura directa para aperto direito e esquerdo  
precisão: ±4%

Com avisadores luminosos e sonoros na medida pré-definida



UNI EN ISO 6789

Nm	Kgfm	lbf.ft	lbf.in	A mm	L mm	kg	kg
80÷400	8÷40	60÷300	3/4	111	710	3,2	10

596/40SL 2.140,00 1 005960010

Nm	Kgfm	lbf.ft	lbf.in	A mm	L mm	kg	kg
160÷800	16÷80	120÷600	3/4"	115	1025	4,85	20

596/80SL 2.690,00 1 005960020



# Beta

## 599DGT

chave eletrônica com roquete reversível, aperto à direita (precisão:  $\pm 2\%$ ) e à (esquerda precisão:  $\pm 3\%$ )

- Modo de medição dupla: pico e curso
- Indicadores luminosos e acústicos informam o utilizador que o valor pré-selecionado foi atingido
- Alimentação: 2 pilhas 1.5V (incluídas)



UNI EN ISO 6789

Nm	Kgfm	lbf.ft	D	A	L	W
12÷60	1,2÷6	8÷44	3/8	30	33	413
						0,9
						0,1

599DGT/6	€ 455,00	1	005990003
----------	----------	---	-----------

Nm	Kgfm	lbf.ft	D	A	L	W
20÷100	2÷10	15÷80	1/2	30	37	413
						0,9
						0,1

599DGT/10X	€ 468,00	1	005990010
------------	----------	---	-----------

Nm	Kgfm	lbf.ft	D	A	L	W
40÷200	4÷20	30÷150	1/2	40	43	520
						2
						0,1

599DGT/20	€ 487,00	1	005990020
-----------	----------	---	-----------

Nm	Kgfm	lbf.ft	D	A	L	W
68÷340	6,8÷34	58÷280	1/2	40	43	640
						2,35
						0,1

599DGT/30	€ 525,00	1	005990030
-----------	----------	---	-----------

## 599DGT-AW

chave dinamométrica eletrônica, leitura do binário e ângulo, com roquete reversível, e transmissão de dados sem fios, para aperto à direita (precisão:  $\pm 2\%$ ) e à esquerda (precisão:  $\pm 3\%$ )

- Tipos de aperto: binário, ângulo, binário + ângulo
- Modo de medição duplo: pico e curso
- Indicador luminoso, sinal acústico e tátil informam o utilizador que o valor pré-selecionado foi atingido
- Permite guardar e visualizar as últimas 999 leituras de pico e/ou ângulo
- Predefinição até 9 valores binário/ângulo
- Transmissão bidirecional de dados sem fios, da chave para o software e vice-versa, em massa a posteriori ou em tempo real
- Bloqueio de segurança
- A chave pode ser associada a um determinado utilizador através de software
- Rastreabilidade de dados. O software permite armazenar e associar à ID de utilizador a data e hora, número de série da ferramenta, valor de aperto definido e valor alcançado
- Software de processamento de dados personalizado com resultados OK/NG imediatos e fáceis de ler e visualização de gráficos em tempo real
- Punho bicomponente antiderrapante
- Inclui: 3 pilhas AA - 1.5V, cabo USB e software



CE



UNI EN ISO 6789

Nm	Kgfm	lbf.ft	D	A	L	W
6÷30	0,6÷3	4,5÷22	1/4	23,7	20,4	410
						0,8
						0,1

599DGT-AW/30	€ 1.160,00	1	005990702
--------------	------------	---	-----------

Nm	Kgfm	lbf.ft	D	A	L	W
27÷135	2,7÷13,5	20÷100	3/8	30,5	27	445
						1
						1,0

599DGT-AW/135	€ 1.180,00	1	005990713
---------------	------------	---	-----------

Nm	Kgfm	lbf.ft	D	A	L	W
68÷340	6,8÷34	50÷250	1/2	40	37	615
						1,5
						1,0

599DGT-AW/340	€ 1.260,00	1	005990734
---------------	------------	---	-----------

Serviço de calibração de binário no final



## 600

chaves de aperto angular

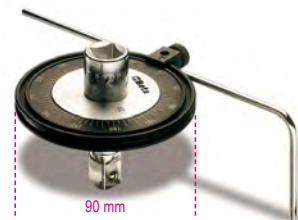

Model	Size	Price (€)	Qty	Code
600/1	1/2	183,00	1	006000001
600/2	3/4	207,00	1	006000002

## 601C

indicador digital ângulo de aperto

Indicador luminoso e um sinal sonoro informam o utilizador que o ângulo programado já foi alcançado



601C	€ 245,00	1	006010100
------	----------	---	-----------

85x80x87 mm - W 70 g

## 601CA

indicador digital ângulo e binário de aperto

Indicador luminoso e um sinal sonoro informam o utilizador que o ângulo programado já foi alcançado



CE



Size	Nm	Price (€)	Qty	Code
1/2"	40÷200	433,00	1	006010120

120x90x120 mm - W 240 g

## 603

chaves dinamométricas com embraiagem de segurança para aperto à direita  
precisão:  $\pm 6\%$



UNI EN ISO 6789

Nm	Kgfm	lbf.in	■	A	L	g	mm
1÷5	0,1÷0,5	10÷45	1/4	35	195	235	0,05

603/5 740,00 1 006030005

Nm	Kgfm	lbf.in	■	A	L	g	mm
2÷10	0,2÷1,0	18÷90	1/4	35	195	235	0,1

603/10 755,00 1 006030010

## 604B

barra dinamométrica para aperto à direita e à esquerda  
precisão de aperto:  $\pm 6\%$



UNI EN ISO 6789

Nm	Kgfm	lbf.in	∅	L	g	mm
1÷5	0,1÷0,5	10÷45	8	220	290	0,025

604B/5 479,00 1 006040015

Nm	Kgfm	lbf.in	∅	L	g	mm
2÷10	0,2÷1,0	18÷90	8	220	300	0,05

604B/10 479,00 1 006040020

## 605E

chaves dinamométricas com desarme sonoro, roquete reversível de aperto à direita e à esquerda  
precisão:  $\pm 6\%$



UNI EN ISO 6789

Nm	Kgfm	lbf.in	■	A	L	g	mm
1÷5	0,1÷0,5	10÷45	1/4	20	190	180	0,05

605E/5 246,00 1 006050105

Nm	Kgfm	lbf.in	■	A	L	g	mm
2÷10	0,2÷1,0	18÷90	1/4	20	190	180	0,1

605E/10 257,00 1 006050110

## 605BC/15

chave dinamométrica com desarme sonoro, com roquete reversível para aperto à direita compacta, em alumínio  
precisão:  $\pm 4\%$



UNI EN ISO 6789

Nm	Kgfm	lbf.in	■	D	A	L	g	mm
3÷15	0,3÷1,5	26÷133	1/4	26	29	175	215	0,1

605BC/15 240,00 1 006050015

## 605DGT/2

chave dinamométrica eletrônica com roquete reversível para aperto à direita/esquerda  
precisão  $\pm 3\%$  (à direita)  
 $\pm 4\%$  (à esquerda)

- Modo de medição duplo: pico e curso
- Indicador luminoso e sinal acústico informam o utilizador de que o valor pré-selecionado foi atingido
- Alimentação: 1 pilha 1.5V AAA (incluída)



UNI EN ISO 6789

Nm	Kgcm	lbf.ft	■	D	A	L	g	mm
4÷20	0,4÷2	35÷177	1/4	20	20	210	175	0,01

605DGT/2 295,00 1 006050302

## 610/5

chaves dinamométricas com roquetes reversíveis, para aperto à direita, com 5 valores programados,  
precisão de aperto:  $\pm 4\%$

Valores de aperto disponíveis:  
90 - 100 - 110 - 120 - 130 Nm



UNI EN ISO 6789

Nm	■	D	A	L	g	mm
90÷130	1/2	42	39	490	1330	10

610/5 205,00 1 006100025

## 610L/5

chaves dinamométricas com alavanca em L para apertos à direita, com 5 valores programados,  
precisão de aperto:  $\pm 4\%$

Valores de aperto disponíveis:  
90 - 100 - 110 - 120 - 130 Nm



UNI EN ISO 6789

Nm	■	L	L1	g	mm
90÷130	1/2	470	80	1350	10

610L/5 183,00 1 006100125

## 610L/5L

chave dinamométrica com alavanca em L, para apertos à direita, com 5 valores pré-regulados,  
precisão de aperto:  $\pm 4\%$

Valores de aperto selecionáveis:  
120 - 140 - 160 - 180 - 200 Nm



UNI EN ISO 6789

Nm	■	L	L1	g	mm
120÷200	1/2	470	80	1400	20

610L/5L 188,00 1 006100150

## 611

roquete reversível para barras dinamométricas refs. 604B/5 e 604B/10  
encabadouro 8 mm



UNI EN ISO 6789

■	L	g	mm
1/4	42,5	173,00	1 006110001

Serviço de calibração de binário no final



## 612 ÷ 614

roquetes reversíveis para barras dinâmicas



As referências 612 e 612X não podem ser usados em apertos cujo torque exceda 100 Nm

	■	L mm	LA mm	€	🔧	📄
612	3/8	66	32	77,50	2	006120000
612X	1/2	66	32	82,00	2	006120010
614	1/2	71	32	89,50	2	006140000
614X	3/4	71	32	98,00	2	006140004

## 614/50

roquete simples para barras dinâmicas



	■	L mm	LA mm	€	🔧	📄
614/50	1/2	71	32	82,00	2	006140002

Mecanismos rotativos de substituição para roquetes



## 615

roquete reversível para barras dinâmicas, encabadouro rectangular



■ mm	■	L mm	LA mm	€	🔧	📄
9x12	3/8	53	28,8	65,50	1	006150010
9x12	1/2	53	28,8	65,50	1	006150020
14x18	1/2	70	39,8	65,50	1	006150120



## 616 - 617 - 619

quadras macho para barras dinâmicas



	■	L mm	LA mm	€	🔧	📄
616	1/4	61	32	61,50	1	006160000
617	3/8	61	32	61,50	1	006170000
619	1/2	63	32	61,50	1	006190000

## 621

calha porta ponteiras para barras dinâmicas, encabadouro rectangular



	■	L mm	LA mm	€	🔧	📄
621P 1/4	9x12	14	43 28,8	78,00	1	006210000
* 621P 5/16	14x18	5/16	52,5 32,5	120,00	1	006210110

\*Atenção! Recalcule o valor do binário a definir conforme ilustrado na tabela da página introdutória da secção

## 622

roquetes reversíveis para barras dinâmicas, encabadouro redondo, Ø 22 mm



	■	L mm	LA mm	€	🔧	📄
622 3/4	3/4	110	56	218,00	1	006220019
622 1"	1	110	56	265,00	1	006220024

## 641

ponteira de boca para barras dinâmicas refs. 604B/5 e 604B/10 encabadouro 8 mm



■ mm	L mm	€	🔧	📄
4	37	93,00	1	006410003
5	37	93,00	1	006410004
5,5	37	93,00	1	006410005
6	37	93,00	1	006410006
7	37	93,00	1	006410007
8	42	93,00	1	006410008
9	42	93,00	1	006410009
10	42	93,00	1	006410010

## 642

ponteiras boca para barras dinâmicas

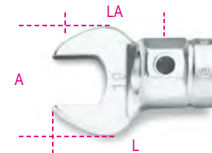

■ mm	L mm	LA mm	A mm	€	🔧	📄
8	54	32	22	66,00	1	006420008
10	57	32	26	66,00	1	006420010
12	58	32	30	66,00	1	006420012
13	58	32	30	66,00	1	006420013
14	59	32	32	66,00	1	006420014
15	59	32	35	66,00	1	006420015
16	59	32	38	66,00	1	006420016
17	60	32	39	66,00	1	006420017
18	61	32	42	66,00	1	006420018
19	61	32	43	66,00	1	006420019
20	61	32	50	103,00	1	006420020
21	62	32	53	103,00	1	006420021
22	62	32	53	113,00	1	006420022
23	65	32	53	113,00	1	006420023
24	63	32	53	113,00	1	006420024
25	64	32	53	138,00	1	006420125
26	64	32	59	138,00	1	006420026
27	65	32	59	138,00	1	006420027
28	66	32	64	138,00	1	006420028
30	66	32	66	138,00	1	006420030
32	67	32	66	138,00	1	006420032
* 36	76	42	80	189,00	1	006420036
* 40	77	52	95	189,00	1	006420040
* 41	78	52	95	189,00	1	006420041
* 46	90	52	95	227,00	1	006420046

\*Atenção! Recalcule o valor do binário a definir conforme ilustrado na tabela da página introdutória da secção



## 643

ponteiros de boca para barras de aperto, encabadoiro rectangular

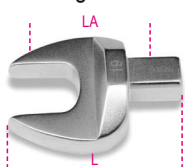

mm	mm	L mm	LA mm	€		
7	9X12	37	28,8	58,00	1	006430007
8	9x12	37	28,8	58,00	1	006430008
10	9x12	39	28,8	58,00	1	006430010
12	9x12	39	28,8	58,00	1	006430012
13	9x12	39	28,8	58,00	1	006430013
14	9x12	43	28,8	58,50	1	006430014
15	9x12	43	28,8	58,50	1	006430015
16	9x12	43	28,8	58,50	1	006430016
17	9x12	43	28,8	58,50	1	006430017
*18	9x12	47	36,3	58,50	1	006430018
*19	9x12	51	36,3	58,50	1	006430019
*21	9x12	52	36,3	90,50	1	006430021
*22	9x12	52	36,3	90,50	1	006430022

\*Atenção! Recalcule o valor do binário a definir conforme ilustrado na tabela da página introdutória da secção

mm	mm	L mm	LA mm	€		
13	14x18	60	39,8	60,50	1	006430113
14	14x18	58	39,8	60,50	1	006430114
15	14x18	60	39,8	60,50	1	006430115
16	14x18	60	39,8	61,50	1	006430116
17	14x18	60	39,8	61,50	1	006430117
18	14x18	61	39,8	61,50	1	006430118
19	14x18	61	39,8	61,50	1	006430119
21	14x18	61	39,8	95,50	1	006430121
22	14x18	62	39,8	95,50	1	006430122
24	14x18	64	39,8	95,50	1	006430124
*27	14x18	68	44,8	108,00	1	006430127
*30	14x18	77	49,8	109,00	1	006430130
*32	14x18	77	49,8	109,00	1	006430132
*34	14x18	80	54,8	173,00	1	006430134
*36	14x18	83	54,8	173,00	1	006430136
*38	14x18	83	54,8	173,00	1	006430138
*41	14x18	91	64,8	173,00	1	006430141

\*Atenção! Recalcule o valor do binário a definir conforme ilustrado na tabela da página introdutória da secção

## 644

ponteiros de boca para barras dinâmicas, encabadoiro redondo, Ø 22 mm



mm	L mm	LA mm	A mm	€		
22	91	56	52	113,00	1	006440022
24	91	56	52	113,00	1	006440024
27	94	56	64	138,00	1	006440027
30	94	56	64	138,00	1	006440030
32	97	56	75,5	138,00	1	006440032
34	97	56	75,5	138,00	1	006440034
36	97	56	75,5	189,00	1	006440036
41	103,5	56	94	189,00	1	006440041
46	115,5	56	94	227,00	1	006440046

## 650A

Chaves de abertura variável para barras dinâmicas, encabadoiro rectangular

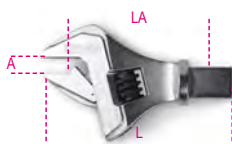

A min-max mm	mm	L mm	LA mm	€		
*5-27	9X12	93	74,3	106,00	1	006500027
*5-30	9X12	106	85,3	106,00	1	006500030
*5-30	14X18	115	89	108,00	1	006500130
*10-41	14X18	127	100	112,00	1	006500141

\*Atenção! Recalcule o valor do binário a definir conforme ilustrado na tabela da página introdutória da secção

## 650H

Chaves de unha para barras dinâmicas, encabadoiro rectangular



mm	mm	L mm	LA mm	€		
*28-36	14x18	122	92	56,50	1	006500928
*40-45	14x18	129	92	56,50	1	006500940
*50-55	14x18	129	92	56,50	1	006500950
*58-62	14x18	135	92	59,50	1	006500958
*68-75	14x18	139	92	65,00	1	006500968
*80-90	14x18	145	92	65,00	1	006500980

\*Atenção! Recalcule o valor do binário a definir conforme ilustrado na tabela da página introdutória da secção

## 652

ponteiros de luneta para barras dinâmicas



mm	L mm	LA mm	€		
8	58	32	71,50	1	006520008
10	58	32	71,50	1	006520010
12	58	32	71,50	1	006520012
13	58	32	71,50	1	006520013
14	58	32	71,50	1	006520014
15	62	32	71,50	1	006520015
16	63	32	71,50	1	006520016
17	64	32	71,50	1	006520017
18	65	32	71,50	1	006520018
19	65	32	71,50	1	006520019
21	67	32	108,00	1	006520021
22	68	32	114,00	1	006520022
24	69	32	136,00	1	006520024
26	71	32	153,00	1	006520026
27	71	32	153,00	1	006520027
30	73	32	153,00	1	006520030
32	74	32	153,00	1	006520032

## 653

ponteiros de luneta para barras de aperto, encabadoiro rectangular

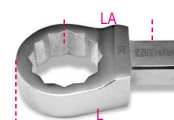

mm	mm	L mm	LA mm	€		
7	9X12	40	28,8	62,00	1	006530007
8	9x12	40	28,8	62,00	1	006530008
10	9x12	43	28,8	62,00	1	006530010
12	9x12	44	28,8	62,00	1	006530012
13	9x12	44	28,8	62,00	1	006530013
14	9x12	45	28,8	62,00	1	006530014
15	9x12	46	28,8	62,00	1	006530015
16	9x12	47	28,8	62,50	1	006530016
17	9x12	47	28,8	62,50	1	006530017
18	9x12	48	28,8	62,50	1	006530018
19	9x12	49	28,8	62,50	1	006530019
21	9x12	51	28,8	65,00	1	006530021
22	9x12	51	28,8	65,00	1	006530022

mm	mm	L mm	LA mm	€		
13	14x18	61	39,8	68,50	1	006530113
14	14x18	61	39,8	68,50	1	006530114
15	14x18	62	39,8	68,50	1	006530115
16	14x18	63	39,8	69,00	1	006530116
17	14x18	64	39,8	69,00	1	006530117
18	14x18	64	39,8	69,00	1	006530118
19	14x18	66	39,8	69,00	1	006530119
21	14x18	66	39,8	99,50	1	006530121
22	14x18	67	39,8	99,50	1	006530122
24	14x18	69	39,8	124,00	1	006530124
*27	14x18	76	44,8	124,00	1	006530127
*30	14x18	77	44,8	124,00	1	006530130
*32	14x18	79	44,8	124,00	1	006530132
*34	14x18	80	44,8	176,00	1	006530134
*36	14x18	80	44,8	176,00	1	006530136
*38	14x18	90	49,8	180,00	1	006530138
*41	14x18	90	49,8	180,00	1	006530141

\*Atenção! Recalcule o valor do binário a definir conforme ilustrado na tabela da página introdutória da secção





## 654

chaves de luneta  
para barras dinamométricas,  
encabadouro, Ø 22 mm



mm	L mm	LA mm	A mm	€		
22	98,5	56	38	114,00	1	006540022
24	98,5	56	38	136,00	1	006540024
27	102,8	56	46,5	153,00	1	006540027
30	102,8	56	46,5	153,00	1	006540030
32	106,5	56	55	153,00	1	006540032
34	106,5	56	55	153,00	1	006540034
36	106,5	56	55	199,00	1	006540036
41	115,5	56	72	199,00	1	006540041
46	115,5	56	72	216,00	1	006540046

## 659/15

adaptador com quadra retangular fêmea  
(14x18 mm) e macho (9x12 mm)



L mm	□ mm	■ mm	LA mm	€		
51	14x18	9x12	32	90,00	1	006590815

\*Atenção! Recalcule o valor do binário a definir  
conforme ilustrado na tabela da página introdutória da  
secção



Aplique sempre uma força de aperto regular  
e progressiva, a fim de evitar a ruptura  
do material e de se proteger  
de um possível acidente

## 659/16

adaptador com quadra retangular fêmea (9x12  
mm) e macho (14x18 mm)



L mm	□ mm	■ mm	LA mm	€		
51	9x12	14x18	31	76,50	1	006590816

\*Atenção! Recalcule o valor do binário a definir  
conforme ilustrado na tabela da página introdutória da  
secção



## 666 - 667 ZERO-RESET

### AS NOVAS CHAVES QUE NÃO REQUEREM LIBERTAÇÃO DE TENSÃO APÓS A UTILIZAÇÃO.

Mesmo que a tensão não seja libertada,  
o número de ciclos, durabilidade  
e precisão de aperto exigidos pelas  
normas de referência são garantidos.

Para confirmar estes parâmetros,  
o Departamento de Pesquisa e Desenvolvimento  
da Beta Utensili realizou vários testes  
de resistência nos seus laboratórios e em  
centenas de utilizadores finais.

Este resultado foi obtido através de:

- utilização dos materiais com melhor  
desempenho atualmente disponíveis;
- tratamento térmico especial  
nos componentes internos

### FABRICO 100% ITALIANO

A chave dinamométrica Zero Reset foi totalmente  
desenvolvida internamente e é produzida nas fábricas  
da Beta Utensili em Itália, utilizando peças 100%  
italianas.

As definições da chave já não precisam de ser  
restauradas ao nível mínimo no final do ciclo de  
utilização.

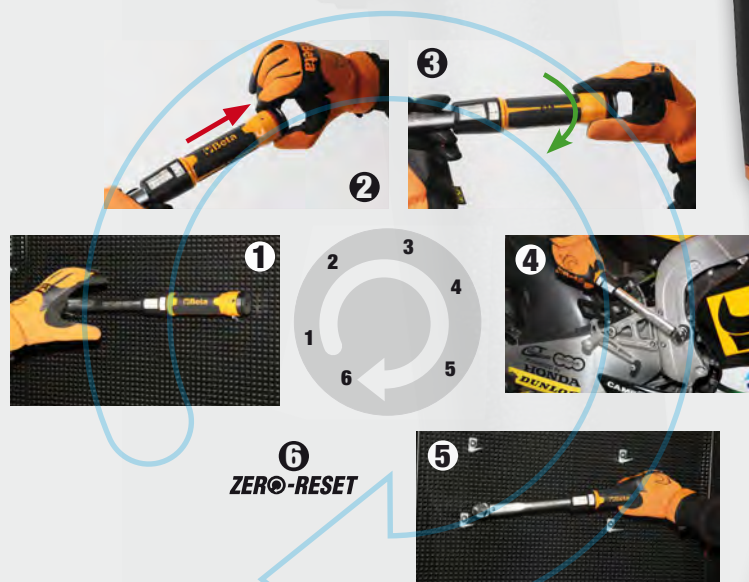



# 666

chaves dinâmicas ZERO-RESET com roquetes reversíveis, para aperto à direita, precisão de torque: ±3%

• Não é necessário libertar a tensão



UNI EN ISO 6789

Nm	5=25	1/4	D mm	26	A mm	25	L mm	273	g	395	0,05
----	------	-----	------	----	------	----	------	-----	---	-----	------

666/2	300,00	1	006660702
-------	--------	---	-----------

Nm	5=25	3/8	D mm	26	A mm	29	L mm	273	g	405	0,05
----	------	-----	------	----	------	----	------	-----	---	-----	------

666/2X	300,00	1	006660703
--------	--------	---	-----------

Nm	10=50	3/8	D mm	30	A mm	33	L mm	342	g	680	0,25
----	-------	-----	------	----	------	----	------	-----	---	-----	------

666/5	273,00	1	006660705
-------	--------	---	-----------

Nm	20=100	3/8	D mm	30	A mm	33	L mm	385	g	760	0,25
----	--------	-----	------	----	------	----	------	-----	---	-----	------

666/10	275,00	1	006660710
--------	--------	---	-----------

Nm	20=100	1/2	D mm	30	A mm	37	L mm	385	g	770	0,25
----	--------	-----	------	----	------	----	------	-----	---	-----	------

666/10X	281,00	1	006660711
---------	--------	---	-----------

Nm	40=200	1/2	D mm	42	A mm	43	L mm	471	g	1020	0,5
----	--------	-----	------	----	------	----	------	-----	---	------	-----

666/20	299,00	1	006660720
--------	--------	---	-----------

Nm	60=300	1/2	D mm	42	A mm	43	L mm	600	g	1270	1,0
----	--------	-----	------	----	------	----	------	-----	---	------	-----

666/30	339,00	1	006660730
--------	--------	---	-----------

# 666 LBF.FT

chaves dinâmicas ZERO-RESET com roquetes reversíveis, para aperto à direita, precisão de torque: ± 3%

• Não é necessário libertar a tensão  
• Escala em lbf.ft



UNI EN ISO 6789

lbf.ft	4=18	1/4	D mm	26	A mm	25	L mm	273	g	395	0,05
--------	------	-----	------	----	------	----	------	-----	---	-----	------

666 LBF.FT/2	284,00	1	006660762
--------------	--------	---	-----------

lbf.ft	4=18	3/8	D mm	26	A mm	29	L mm	273	g	405	0,05
--------	------	-----	------	----	------	----	------	-----	---	-----	------

666 LBF.FT/2X	284,00	1	006660763
---------------	--------	---	-----------

lbf.ft	7=37	3/8	D mm	30	A mm	33	L mm	342	g	680	0,25
--------	------	-----	------	----	------	----	------	-----	---	-----	------

666 LBF.FT/5	258,00	1	006660765
--------------	--------	---	-----------

lbf.ft	15=75	3/8	D mm	30	A mm	33	L mm	385	g	760	0,25
--------	-------	-----	------	----	------	----	------	-----	---	-----	------

666 LBF.FT/10	260,00	1	006660780
---------------	--------	---	-----------

lbf.ft	15=75	1/2	D mm	30	A mm	37	L mm	385	g	770	0,25
--------	-------	-----	------	----	------	----	------	-----	---	-----	------

666 LBF.FT/10X	265,00	1	006660781
----------------	--------	---	-----------

lbf.ft	30=150	1/2	D mm	42	A mm	43	L mm	471	g	1020	0,5
--------	--------	-----	------	----	------	----	------	-----	---	------	-----

666 LBF.FT/20	283,00	1	006660782
---------------	--------	---	-----------

lbf.ft	50=230	1/2	D mm	42	A mm	43	L mm	600	g	1270	1,0
--------	--------	-----	------	----	------	----	------	-----	---	------	-----

666 LBF.FT/30	321,00	1	006660783
---------------	--------	---	-----------

# 667

chave dinâmática ZERO-RESET com roquete reversível, para aperto à direita/esquerda, precisão de torque: ±3%

• Não requer libertação de tensão



UNI EN ISO 6789

Nm	40=200	1/2	D mm	42	A mm	42	L mm	471	g	1035	0,5
----	--------	-----	------	----	------	----	------	-----	---	------	-----

667/20	294,00	1	006670720
--------	--------	---	-----------

Nm	60=300	1/2	D mm	42	A mm	42	L mm	600	g	1285	1,0
----	--------	-----	------	----	------	----	------	-----	---	------	-----

667/30	327,00	1	006670730
--------	--------	---	-----------

Nm	80=400	3/4	D mm	59	A mm	53	L mm	710	g	2220	1,0
----	--------	-----	------	----	------	----	------	-----	---	------	-----

667/40	790,00	1	006670740
--------	--------	---	-----------

# Mecanismos rotativos de substituição para roquetes



# 668N

barras de aperto, para operações à esquerda e à direita, precisão de torque: ±3%



UNI EN ISO 6789

Nm	5=25	Kgfm	0,5=2,5	lbf.ft	4=18	Ø mm	16	L mm	220	LB mm	148	LS mm	32	g	300	0,2
----	------	------	---------	--------	------	------	----	------	-----	-------	-----	-------	----	---	-----	-----

668N/2	275,00	1	006680002
--------	--------	---	-----------

Nm	10=50	Kgfm	1=5	lbf.ft	7=37	Ø mm	16	L mm	307	LB mm	229	LS mm	32	g	590	0,5
----	-------	------	-----	--------	------	------	----	------	-----	-------	-----	-------	----	---	-----	-----

668N/5	269,00	1	006680005
--------	--------	---	-----------

Nm	20=100	Kgfm	2=10	lbf.ft	15=75	Ø mm	16	L mm	376	LB mm	269	LS mm	32	g	670	1,0
----	--------	------	------	--------	-------	------	----	------	-----	-------	-----	-------	----	---	-----	-----

668N/10	275,00	1	006680010
---------	--------	---	-----------

Nm	40=200	Kgfm	4=20	lbf.ft	30=150	Ø mm	16	L mm	450	LB mm	352,6	LS mm	32	g	795	2,0
----	--------	------	------	--------	--------	------	----	------	-----	-------	-------	-------	----	---	-----	-----

668N/20	299,00	1	006680020
---------	--------	---	-----------

Nm	60=300	Kgfm	6=30	lbf.ft	50=220	Ø mm	16	L mm	588	LB mm	475,9	LS mm	32	g	1230	2,0
----	--------	------	------	--------	--------	------	----	------	-----	-------	-------	-------	----	---	------	-----

668N/30	339,00	1	006680030
---------	--------	---	-----------



# Beta

## 668RG

barra dinâmométrica, não graduada, para aperto à direita e à esquerda  
precisão:  $\pm 4\%$   
(para utilização com artigos 680 - 682)



UNI EN ISO 6789

Nm	Kgfm	lbf.ft	Ø mm	L mm	W g
8÷60	0,8÷6	6÷44	16	288	550

<b>668RG/6</b>	<b>222,00</b>	1	006680206
----------------	---------------	---	-----------

Nm	Kgfm	lbf.ft	Ø mm	L mm	W g
20÷100	2÷10	15÷80	16	315	600

<b>668RG/10</b>	<b>228,00</b>	1	006680210
-----------------	---------------	---	-----------

Nm	Kgfm	lbf.ft	Ø mm	L mm	W g
40÷200	4÷20	30÷150	16	405	780

<b>668RG/20</b>	<b>243,00</b>	1	006680220
-----------------	---------------	---	-----------

Nm	Kgfm	lbf.ft	Ø mm	L mm	W g
60÷300	6÷30	50÷220	16	645	1130

<b>668RG/30</b>	<b>271,00</b>	1	006680230
-----------------	---------------	---	-----------

## 668RGC

chave dinâmométrica, não graduada, com roquete reversível, para aperto à direita, precisão de torque:  $\pm 4\%$   
(para utilização com referências 680 - 682)



UNI EN ISO 6789

Nm	Kgfm	lbf.ft	■ mm	D mm	A mm	L mm	W g
12÷60	1,2÷6	5÷45	3/8	30	33	295	600

<b>668RGC/6</b>	<b>202,00</b>	1	006680406
-----------------	---------------	---	-----------

Nm	Kgfm	lbf.ft	■ mm	D mm	A mm	L mm	W g
20÷100	2÷10	15÷75	3/8	30	33	335	700

<b>668RGC/10</b>	<b>211,00</b>	1	006680410
------------------	---------------	---	-----------

Nm	Kgfm	lbf.ft	■ mm	D mm	A mm	L mm	W g
20÷100	2÷10	15÷75	1/2	40	43	342	700

<b>668RGC/10X</b>	<b>211,00</b>	1	006680411
-------------------	---------------	---	-----------

Nm	Kgfm	lbf.ft	■ mm	D mm	A mm	L mm	W g
40÷200	4÷20	30÷150	1/2	40	43	425	1000

<b>668RGC/20</b>	<b>216,00</b>	1	006680420
------------------	---------------	---	-----------

## 669N

barras dinâmométricas, encabadouro retangular fêmea, para operações à esquerda e à direita, precisão de torque:  $\pm 3\%$



UNI EN ISO 6789

Nm	Kgfm	lbf.ft	□ mm	L mm	LB mm	LS mm	W g
5÷25	0,5÷2,5	4÷18	9x12	215	140	28,8	300

<b>669N/2</b>	<b>392,00</b>	1	006690202
---------------	---------------	---	-----------

Nm	Kgfm	lbf.ft	□ mm	L mm	LB mm	LS mm	W g
10÷50	1÷5	7÷37	9x12	307	226,8	28,8	590

<b>669N/5</b>	<b>301,00</b>	1	006690205
---------------	---------------	---	-----------

Nm	Kgfm	lbf.ft	□ mm	L mm	LB mm	LS mm	W g
20÷100	2÷10	15÷75	9x12	376	266,8	28,8	670

<b>669N/10</b>	<b>324,00</b>	1	006690210
----------------	---------------	---	-----------

Nm	Kgfm	lbf.ft	□ mm	L mm	LB mm	LS mm	W g
40÷200	4÷20	30÷150	9x12	450	345,6	28,8	795

<b>669N/20</b>	<b>389,00</b>	1	006690220
----------------	---------------	---	-----------

Nm	Kgfm	lbf.ft	□ mm	L mm	LB mm	LS mm	W g
40÷200	4÷20	30÷150	14x18	450	351	39,8	795

<b>669N/20X</b>	<b>410,00</b>	1	006690221
-----------------	---------------	---	-----------

Nm	Kgfm	lbf.ft	□ mm	L mm	LB mm	LS mm	W g
60÷300	6÷30	50÷220	14x18	588	468,5	39,8	1230

<b>669N/30</b>	<b>433,00</b>	1	006690230
----------------	---------------	---	-----------

Nm	Kgfm	lbf.ft	□ mm	L mm	LB mm	LS mm	W g
80÷400	8÷40	60÷295	14x18	664	563	39,8	2100

<b>669N/40</b>	<b>499,00</b>	1	006690240
----------------	---------------	---	-----------



## 671B/C5

Jogo com 1 barra dinâmométrica ref. 604B/5, 1 roquete reversível, 8 chaves de caixa sextavadas e 4 ponteiros boca



<b>671B/C5</b>	<b>1.100,00</b>	1	006710001
----------------	-----------------	---	-----------

604B/5	1÷5 Nm
611	1/4
641	5-6-7-8 mm
900	4-5-5,5-6-7-8-9-10 mm

270x120x45 mm - 1,3 kg

## 671B/C10

Jogo com 1 barra dinâmométrica ref. 604B/10, 1 roquete reversível, 8 chaves de caixa sextavadas e 4 ponteiros boca



<b>671B/C10</b>	<b>1.100,00</b>	1	006710002
-----------------	-----------------	---	-----------

604B/10	2÷10 Nm
611	1/4
641	6-7-8-10 mm
900	4-5-5,5-6-7-8-9-10 mm

270x120x45 mm - 1,4 kg

## 671N/C10

barra dinâmométrica 668N/10 e acessórios



<b>671N/C10</b>	<b>1.240,00</b>	1	006710110
-----------------	-----------------	---	-----------

668N/10	100 Nm
612	■ 3/8
617	■ 3/8
642	10-13-14-17-19 mm
652	10-13-14-17-19 mm
910A	□ 3/8 8-10-11-13-14-17-19 mm
910/21	125 mm
910/22	250 mm

400x180x45 mm - 4,3 kg

## 671N/C20

barra dinamométrica 668N/20 e acessórios

12" 16



671N/C20 € 1.310,00 1 006710120

668N/20	200 Nm
614	■ 1/2
619	■ 1/2
642	10-13-14-17-19 mm
652	10-13-14-17-19 mm
920A	□ 1/2 10-11-13-14-17-19-22 mm
920/20	75 mm
920/21	125 mm
920/22	255 mm

510x180x45 mm - 5,5 kg

## 671N/C30

barra dinamométrica 668N/30 e acessórios

12" 16



671N/C30 € 1.250,00 1 006710130

668N/30	300 Nm
614	■ 1/2
619	■ 1/2
642	13-14-17-19 mm
652	13-14-17-19 mm
920A	□ 1/2 13-14-17-19-22-24-27 mm
920/20	75 mm
920/21	125 mm
920/22	255 mm

620x180x45 mm - 5,8 kg



## 674/C

barras dinamométricas não graduadas, encabadouro redondo Ø 22 mm, para aperto à direita e à esquerda, precisão: ± 4%, em estojo

22



UNI EN ISO 6789

Nm	Kgfm	lbf.ft	Ø mm	L mm	LB mm	LS mm	kg	10
100÷500	10÷50	80÷400	22	786	725	56	3,4	1,25

674/C50 € 910,00 1 006740005

Nm	Kgfm	lbf.ft	Ø mm	L mm	LB mm	LS mm	kg	2,0
160÷800	16÷80	120÷600	22	997	915	56	4,5	2,0

674/C80 € 965,00 1 006740008

Nm	Kgfm	lbf.ft	Ø mm	L mm	LB mm	LS mm	kg	2,5
200÷1000	20÷100	150÷750	22	997	915	56	4,5	2,5

674/C100 € 975,00 1 006740010

## 677

Chave dinamométrica com roquete reversível para aperto à esquerda e à direita, precisão ±4% fornecidas em estojo

34"



UNI EN ISO 6789

Nm	Kgfm	lbf.ft	D mm	A mm	L mm	kg	10
120÷600	12÷60	100÷450	69	55	1059	6,0	10

677/600 € 1.020,00 1 006770006

Nm	Kgfm	lbf.ft	D mm	A mm	L mm	kg	10
200÷800	20÷80	150÷600	69	55	1319	6,7	10

677/800 € 1.070,00 1 006770008

Nm	Kgfm	lbf.ft	D mm	A mm	L mm	kg	20
300÷1000	30÷100	200÷750	69	55	1554	7,4	20

677/1000 € 1.140,00 1 006770010

## 677/C

chaves dinamométricas com roquetes móveis, para aperto à esquerda e à direita, precisão de torque: ±4% fornecidas em estojo

34"



UNI EN ISO 6789

Nm	Kgfm	lbf.ft	D mm	A mm	L mm	kg	10
120÷600	12÷60	100÷450	69	55	1059	6,0	10

677/C600 € 1.210,00 1 006770607

Nm	Kgfm	lbf.ft	D mm	A mm	L mm	kg	10
200÷800	20÷80	150÷600	69	55	1319	6,7	10

677/C800 € 1.250,00 1 006770612

Nm	Kgfm	lbf.ft	D mm	A mm	L mm	kg	20
300÷1000	30÷100	200÷750	69	55	1554	7,4	20

677/C1000 € 1.330,00 1 006770616

Nm	Kgfm	lbf.ft	D mm	A mm	L mm	kg	25
700÷1500	70÷150	500÷1000	69	55	1869	9,6	25

677/C1500 € 1.700,00 1 006770621

## 677/CP2000

chave dinamométrica com embraiagem e roquete simples para aperto à direita e esquerda precisão: ±4% em estojo

1"



UNI EN ISO 6789

Nm	Kgfm	lbf.ft	D mm	A mm	L mm	kg	50
900÷2000	90÷200	700÷1500	69	63	1940	12,75	50

677/CP2000 € 3.110,00 1 006770721







## 678/C

chaves dinamométricas com roquetes móveis para aperto à esquerda e à direita precisão  $\pm 4\%$  fornecidas em estojo

• Modelos 678/C100 e 678/C150 fornecidos com extensões.

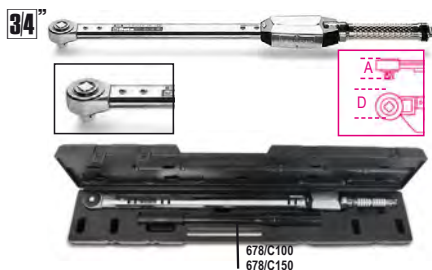

UNI EN ISO 6789

Nm	Kgfm	lbf.ft	D mm	A mm	L mm	kg	mm
130÷650	13÷65	100÷480	63	55	885	3,9	5,0

€	kg	mm
1.880,00	1	006780607

Nm	Kgfm	lbf.ft	D mm	A mm	L mm	kg	mm
300÷1000	30÷100	220÷750	75	60	1250	6,0	10

€	kg	mm
2.490,00	1	006780611

Nm	Kgfm	lbf.ft	D mm	A mm	L mm	kg	mm
500÷1500	50÷150	370÷1100	75	60	1570	8,5	10

€	kg	mm
2.710,00	1	006780615

## 677/CV - 678/CV

caixas metálicas para chaves dinamométricas modelos 677 e 678

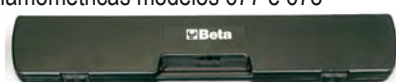

€	kg	mm
185,00	1	006770455
243,00	1	006770460
175,00	1	006780455
197,00	1	006780500
324,00	1	006780415

## 680

medidor de torque digital eletrônico Dynatester 680 para testes de calibragem, operação à esquerda e à direita

- Precisão:  $\pm 1\%$  do valor lido
- Monitor LCD a cores, 4 dígitos
- 3 unidades de medição: Nm - lbf.ft. - lbf.in



	Nm	kg	€	kg	mm
680/3	0,1÷3	1,4	3.190,00	1	006800000
680/30	1,5÷30	1,4	3.140,00	1	006800003
680/350	10÷350	2,6	3.160,00	1	006800035
680/2100	200÷2100	3,5	4.690,00	1	006800210

## 682

controlador de binário electrónico digital com transdutor Dynatester 682, para uso à direita e à esquerda

Alta precisão de leitura  
Fornecido com porta série RS-232 para impressoras



### CARACTERÍSTICAS TÉCNICAS

Precisão de leitura:  $\pm 1\%$  do valor lido

Unidades de medida selecionáveis

Nm-dNm-cNm-Lbf.ft-Lbf.in-Ozf.in-Kgf.m-Kgf.cm-gf.cm

Alimentação: 90 a 264 V AC a 50/60 Hz

Dimensões: 235x185x185 mm

Tolerância de teste de acordo com a norma ISO 6789

Escala aceite para cada chave dinamométrica testada

Visor: Menu disponível em 11 línguas

Fornecido com todos os certificados necessários

Certificado de calibração com rastreabilidade UKAS

	Nm	kg	€	kg	mm
682/60	1,2÷60	5,9	6.550,00	1	006820006
682/400	8÷400	6,1	6.650,00	1	006820040
682/1500	30÷1500	6,4	6.850,00	1	006820150

## CHAVES DE IMPACTO



Em comparação com as chaves de caixa, as chaves de impacto têm dimensões maiores, pelo que conseguem absorver apertos elevados como os que são produzidos pelas chaves de impacto e pelos multiplicadores de binário.

O perfil sextavado proporciona maior durabilidade em utilização intensiva. Devem ser utilizadas com pinos e anilhas para impedir que se soltem do encabadouro.

Tal como acontece nos modelos clássicos para as versões standard e longas, está também disponível uma série longa e estreita destas chaves, para utilização em espaços a que não é possível aceder com os modelos standard. Contudo, considerando a sua força significativamente inferior, é recomendável uma utilização cuidadosa.



## 710

chaves de impacto série normal



UNI/ISO 2725 DIN 3129

mm	Ø mm	L mm	Ø1 mm	€	🔧	📦
7	12,5	28	19	9,60	3	007100007
8	13,8	28	19	9,60	3	007100008
9	15,0	28	19	9,60	3	007100009
10	16,3	28	19	9,60	3	007100010
11	17,5	30	19	9,60	3	007100011
12	19,0	30	19	9,60	3	007100012
13	20,0	30	22	10,10	3	007100013
14	21,3	30	22	10,10	3	007100014
16	23,8	30	22	10,20	3	007100016
17	25,0	30	22	10,20	3	007100017
18	26,3	30	22	10,50	3	007100018
19	27,5	30	22	10,50	3	007100019
21	30,0	32	22	11,60	3	007100021
22	32,0	32	22	12,90	3	007100022

## 710/C10

jogo com 10 chaves de impacto



710/C10  
7-8-10-11-12-13  
14-17-19-22 mm

€ 145,00 1 007100910

130x55x40 mm - 800 g

## 710/16

adaptador quadra fêmea de 3/8" para quadra macho de 1/2"



L mm	Ø mm	□	■	€	🔧	📦
32	22	3/8	1/2	26,00	3	007100810

## 710/20

extensões com quadras macho e fêmea de 3/8"



L mm	Ø mm	€	🔧	📦
75	22	26,50	2	007100821

## 710/21

extensões com quadras macho e fêmea de 3/8"



L mm	Ø mm	€	🔧	📦
125	22	29,00	2	007100823

## 710/22

extensão com quadras macho e fêmea de 3/8"



L mm	Ø mm	€	🔧	📦
150	22	34,00	2	007100825

## 710/25

cardan com quadras macho e fêmea de 3/8"



L mm	Ø mm	€	🔧	📦
58	24	53,50	2	007100830

## 710/OR... - 710/SP...

anéis em borracha e cavilhas de fixação para chaves de impacto e acessórios



	710 mm	710/16 L mm	€	🔧	📦
710/OR1	7+12		0,80	10	007100921
710/OR2	13+22	32	0,80	10	007100922
710/SP1	7+12		1,46	10	007100911
710/SP2	13+22	32	1,46	10	007100912



## 720

chaves de impacto série normal



UNI/ISO 2725 DIN 3129

mm	Ø mm	L mm	Ø1 mm	€	🔧	📦
8	15,0	38	25	11,50	5	007200008
9	16,0	38	25	11,50	5	007200009
10	17,0	38	25	11,70	5	007200010
11	18,5	38	25	11,70	5	007200011
12	20,0	38	25	11,70	5	007200012
13	21,0	38	25	11,70	5	007200013
14	22,5	38	25	11,70	5	007200014
15	23,0	38	30	13,10	5	007200015
16	25,0	38	30	13,10	5	007200016
17	26,0	38	30	13,10	5	007200017
18	27,5	38	30	13,10	5	007200018
19	28,5	38	30	13,10	5	007200019
20	30	38	30	14,40	5	007200020
21	31,0	38	30	14,40	5	007200021
22	32,5	38	30	14,70	5	007200022
23	34,0	38	30	16,00	5	007200023
24	35,0	38	30	16,00	5	007200024
27	38,5	45	30	18,60	3	007200027
29	41	47	30	20,30	3	007200029
30	42,0	50	30	20,30	3	007200030
32	44,0	50	30	23,30	3	007200032
36	50,0	50	30	33,50	3	007200036

## 720/C6

jogo com 6 chaves de impacto



720/C6  
13-14-17-19-22-24 mm

€ 119,00 1 007200910

195x80x55 mm - 1100 g

## 720/C12

jogo com 12 chaves de impacto



720/C12  
10-11-12-13-14-17  
19-22-24-27-30-32 mm

€ 216,00 1 007200912

195x80x55 mm - 2000 g

## 720/C24

jogo de 24 chaves de caixa de impacto



720/C24 € 460,00 1 007200904

- 720 10 - 12 - 13 - 14 - 15 - 16 - 17 - 18 - 19 - 21 - 22 - 24 - 27 - 30 - 32 mm
  - 720L 13 - 17 - 19 - 21 - 22 - 24 mm
  - 720LC 17 - 19 - 21 mm
- 420x185x60 mm - 6,2 kg

## 720B

chaves de impacto bisextavadas



UNI/ISO 2725 DIN 3129

mm	Ø mm	L mm	Ø1 mm	€		
10	17	38	25	11,70	5	007201010
11	18	38	25	11,70	5	007201011
12	19	38	25	11,70	5	007201012
13	20	38	25	11,70	5	007201013
14	22	38	25	11,70	5	007201014
15	23	38	30	13,10	5	007201015
16	24	38	30	13,10	5	007201016
17	26	38	30	13,10	5	007201017
18	27	38	30	13,10	5	007201018
19	28	38	30	13,10	5	007201019
21	30	38	30	14,40	5	007201021
22	31,8	38	30	14,70	5	007201022
23	31,8	38	30	16,00	5	007201023
24	33,8	40	30	16,00	5	007201024
27	37,8	43	30	18,60	3	007201027
30	41,8	43	30	20,30	3	007201030
32	43,8	43	30	23,30	3	007201032
36	49,8	50	30	33,50	3	007201036

## 720B/C12

12 chaves de impacto bisextavadas



UNI/ISO 2725 DIN 3129

720B/C12 € 216,00 1 007201912

10-11-12-13-14-17  
19-22-24-27-30-32 mm

195x80x55 mm - 2000 g

## 720MC

chaves de impacto, série standard, coloridas



mm	Ø mm	L mm	€		
10	17,0	38	12,10	3	007202010
11	18,5	38	12,10	3	007202011
12	20,0	38	12,10	3	007202012
13	21,0	38	12,10	3	007202013
14	22,5	38	12,10	3	007202014
15	23,0	38	13,70	3	007202015
16	25,0	38	13,70	3	007202016
17	26,0	38	13,70	3	007202017
18	27,5	38	13,70	3	007202018
19	28,5	38	13,70	3	007202019
21	31,0	38	15,20	2	007202021
22	32,5	38	15,20	2	007202022
24	35,0	38	16,60	2	007202024

## 720MC/C13

13 chaves de impacto, coloridas



720MC/C13 € 220,00 1 007202913

10-11-12-13-14-15  
16-17-18-19-21-22  
24 mm

335x145x60 mm - 2,4 kg

## 720AS

chaves de impacto, série normal



mm	Ø mm	L mm	Ø1 mm	€		
3/8	17,0	38	25	18,90	2	007200210
7/16	18,2	38	25	18,90	2	007200211
1/2	20,7	38	25	18,90	2	007200213
9/16	22,0	38	25	18,90	2	007200214
5/8	24,5	38	30	20,30	2	007200216
11/16	25,7	38	30	20,30	2	007200217
3/4	28,2	38	30	20,30	2	007200219
13/16	30,7	38	30	21,50	2	007200221
7/8	32,0	38	30	21,50	2	007200222
15/16	34,5	38	30	22,90	2	007200224
1	35,7	38	30	24,70	2	007200225
1.1/16	38,2	40	30	27,50	1	007200227
1.1/8	40,7	42	30	30,50	1	007200229
1.1/4	44,5	42	30	34,00	1	007200232

## 720S

chaves de impacto, série compacta



mm	Ø mm	L mm	Ø1 mm	€		
13	20,0	28,0	23,8	7,40	3	007200113
15	23,0	28,0	23,8	7,40	3	007200115
17	25,8	28,0	25,8	8,00	3	007200117
19	27,8	28,0	27,8	8,70	3	007200119
22	31,8	28,0	30,0	9,50	3	007200122
24	33,8	28,0	30,0	10,40	3	007200124



720S/SB6 € 63,00 1 007200906

13-15-17-19-22-24 mm

## 720L

chaves de impacto série longa



UNI/ISO 2725

mm	Ø mm	L mm	Ø1 mm	€		
10	17,0	80	25	20,00	2	007200310
11	18,5	80	25	20,00	2	007200311
12	20,0	80	25	20,00	2	007200312
13	21,0	80	25	20,00	2	007200313
14	22,5	80	25	20,00	2	007200314
15	23,0	80	30	22,70	2	007200315
16	25,0	80	30	22,70	2	007200316
17	26,0	80	30	22,70	2	007200317
18	27,5	80	30	24,00	2	007200318
19	28,5	80	30	24,00	2	007200319
21	31,0	80	30	25,50	2	007200321
22	32,5	80	30	25,50	2	007200322
24	35,0	80	30	26,50	2	007200324
27	38,5	80	30	33,50	2	007200327
30	42,0	80	30	40,50	2	007200330
32	44,0	80	30	40,50	2	007200332
36	50,0	80	30	52,00	2	007200336

## 720L/S3

jogo de 3 chaves de impacto 720L



720L/S3 € 72,00 1 007200355

17-19-21 mm



## 720LS

chaves de impacto,  
série longa



Ø mm	D mm	L mm	Ø1 mm	€	1	2
10	15,5	78	24	21,50	2	007200360
11	16,7	78	24	21,50	2	007200361
12	18,0	78	24	21,50	2	007200362
13	19,2	78	24	21,50	2	007200363
14	20,5	78	24	21,50	2	007200364
15	21,7	78	24	22,20	2	007200365
16	23,0	78	24	22,20	2	007200366
17	24,2	78	29	24,70	2	007200367
18	25,5	78	29	26,50	2	007200368
19	26,7	78	29	26,50	2	007200369
21	29,2	78	29	28,00	2	007200371
22	30,5	78	29	28,00	2	007200372
24	33,0	78	29	28,50	2	007200374
27	36,7	78	29	35,00	2	007200377
30	40,5	78	29	44,00	2	007200380
32	43,0	78	29	46,00	2	007200382
36	48,0	78	29	69,00	2	007200386

## 720LC

chaves de impacto para porcas de roda,  
com inserts coloridos em polímero



Ø mm	mm	€	1	2
17	26,5	14,40	2	007200637
19	28,5	14,40	2	007200639
21	30,3	15,00	2	007200641
22	32,4	15,60	2	007200642
24	34,6	16,90	2	007200644



720LC/C3	€	1	2
17-19-21 mm	43,50	1	007200653

148x132x44 mm - 860 g



720LC/S5	€	1	2
17-19-21-22-24 mm	76,50	1	007200645

## 12"



720LC/PM5	€	1	2
17-19-21-22-24 mm	129,00	1	007200646

## PM 1/2-Q5

calha magnética para chaves de caixa

## 12"



PM 1/2-Q5	€	1	2
	52,00	1	088880233

## 720IC

inserts sobresselentes coloridos em polímero  
para chaves de impacto 720LC-720LCL



720IC	Ø mm	€	1	2
17	17	5,80	1	007200687
19	19	5,80	1	007200689
21	21	5,80	1	007200691
22	22	5,80	1	007200692
24	24	5,80	1	007200694

## 720LCL

chaves de impacto para porcas de roda,  
com inserts coloridos em polímero,  
série longa

## 12"



Ø mm	mm	€	1	2
17	26,5	23,80	1	007200737
19	28,5	23,80	1	007200739
21	30,3	23,80	1	007200741

## 12"



720LCL/C3	€	1	2
17-19-21 mm	91,50	1	007200753

210x50x150 mm - 1,65 kg

## 720MRC

chave de impacto  
com insert polimérico parafusos de rodas  
Mercedes

## 12"



Ø mm	mm	L mm	€	1	2
17	27	85	23,40	1	007200631

## 720FRD

chave de impacto para porcas de rodas Ford  
com tampas em alumínio danificadas

necessária quando as tampas das porcas foram danificadas  
por chaves de impacto

## 12"



Ø mm	L mm	€	1	2
18,5÷19,5	63	22,20	1	007200633

## 720RNG

chave de impacto para porcas de rodas Jeep  
Renegade com tampas de alumínio  
danificadas

necessário quando as tampas das porcas estão danificadas

## 12"



Ø mm	L mm	€	1	2
16,5÷17,5	63	22,20	1	007200634





12"



**720TC/S5** € 126,00 1 007200779  
90-100-110-120-135 Nm  
260x50x175 mm - 1,35 kg

### 720FTX

chaves de caixa para parafusos com perfil Torx®

12"



	Ø mm	L mm	Ø1 mm	€		
E12	15,9	38	25	18,70	2	007200412
E14	17,7	38	25	18,70	2	007200414
E16	20,0	38	25	18,70	2	007200416
E18	22,0	38	25	18,70	2	007200418
E20	25,0	40	25	19,90	2	007200420
E24	30,0	40	30	19,90	2	007200424

12"



**720FTX/SB6** € 125,00 1 007200450  
E10-E12-E14  
E16-E18-E20

### 720TX

chaves de impacto para parafusos Torx®

12"



	Ø mm	L mm	L1 mm	€		
T30	25	78	54	16,40	3	007200460
T40	25	78	54	16,40	3	007200470
T45	25	78	54	16,70	3	007200472
T50	25	78	54	16,70	3	007200474
T55	25	78	54	18,90	3	007200476
T60	25	78	54	20,30	3	007200478

### 720TX/C6

jogo de 6 chaves de impacto para parafusos Torx® em caixa metálica

12"



**720TX/C6** € 138,00 1 007200483  
T30-T40-T45-  
T50-T55-T60

275x120x65 mm - 5700 g

### 720ME

chaves de impacto sextavadas

12"



mm	Ø mm	L mm	L1 mm	€		
5	25	78	54	15,70	3	007200505
6	25	78	54	15,70	3	007200506
8	25	78	54	15,70	3	007200508
10	25	78	54	15,70	3	007200510
12	25	78	54	15,70	3	007200512
14	25	78	54	17,60	3	007200514
17	25	78	54	17,60	3	007200517
19	25	78	54	17,60	3	007200519

### 720ME/C8

jogo de 8 chaves de impacto sextavadas

12"



**720ME/C8** € 169,00 1 007200525  
5-6-8-10-12-  
14-17-19 mm

270x120x45 mm - 1710 g

**9899 720ME/C8** € 15,20 1 098990130  
Tabuleiro maleável, vazio



### 720XZN

chaves de impacto para parafusos XZN®

12"



Ø	Ø mm	L mm	L1 mm	€		
M4	25	77	53	17,80	3	007201504
M5	25	77	53	17,80	3	007201505
M6	25	77	53	17,80	3	007201506
M8	25	77	53	17,80	3	007201508
M10	25	77	53	18,30	3	007201510
M12	25	77	53	18,70	3	007201512
M14	25	77	53	18,70	3	007201514
M16	25	77	53	19,10	3	007201516
M18	25	77	53	20,10	3	007201518

### 720XZN/C6

6 chaves de impacto para parafusos de perfil XZN®

12"



**720XZN/C6** € 145,00 1 007201530  
M8-M10-M12-M14  
M16-M18

275x120x65 mm - 5700 g

### 720/SN

chaves de impacto, série articulada

12"



Ø	Ø mm	L mm	Ø1 mm	€		
17	25,7	69,6	30	82,00	2	007200087
19	28,2	73,6	30	82,00	2	007200089
24	34,5	75,6	30	92,00	2	007200094

## 720/15

adaptador quadra fêmea de 1/2"  
para quadra macho de 3/8"

12"



L	Ø			€		
mm	mm	1/2	3/8			
37,5	25			13,10	3	007200810



Aplique sempre uma força de aperto regular e progressiva, a fim de evitar a ruptura do material e de se proteger de um possível acidente

## 720/16

adaptador quadra fêmea de 1/2"  
para quadra macho de 3/4"

12"



L	Ø			€		
mm	mm	1/2	3/4			
44	30			22,60	3	007200814

## 720/20

extensões com quadras macho e fêmea de 1/2"

12"



L	Ø			€		
mm	mm	1/2	3/4			
75	25			23,30	3	007200818

## 720/21

extensões com quadras macho e fêmea de 1/2"

12"



L	Ø			€		
mm	mm	1/2	3/4			
125	25			25,00	3	007200822

## 720/22

extensão com quadras macho e fêmea de 1/2"

12"



L	Ø			€		
mm	mm	1/2	3/4			
250	25			29,50	3	007200824

## 720/25

cardan com quadras macho e fêmea de 1/2"

12"



L	Ø			€		
mm	mm	1/2	3/4			
64	28			43,00	2	007200831

## 720/OR... - 720/SP...

anéis em borracha e cavilhas de fixação para chaves de impacto e acessórios

12"

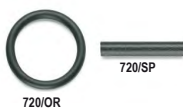

	720	720TX	€		
	Ø mm	Ø			
720/OR1	10+14	T30+T60	1,49	10	007200923
720/OR2	15+36		1,49	10	007200924
720/SP1	10+14	T30+T60	2,20	10	007200913
720/SP2	15+36		2,20	10	007200914

## 727PI/16 1/2

chaves porta-pontas de impacto para artigos 727/ES16, 727/ES16TX e 727/ES16XZN

12"



Ø	L	Ø		€		
mm	mm	mm	1/2			
28	42	16		38,50	2	007270015

## 727PI/16

chave porta-pontas de impacto 16 mm para os artigos 727/ES16 e 727/ES16TX

3/4"



Ø	L	Ø		€		
mm	mm	mm	3/4			
44	52	16		51,00	2	007270016

## 727/ES16

pontas de impacto sextavados 16 mm



mm	Ø	L	€		
mm	mm	mm			
10	16	40	17,20	2	007270110
12	16	40	17,20	2	007270112
13	16	40	17,20	2	007270113
14	16	40	17,20	2	007270114
16	16	40	18,50	2	007270116
17	16	40	18,50	2	007270117
18	16	40	19,20	2	007270118
19	16	40	19,20	2	007270119
22	16	40	22,20	2	007270122

## 727/ES16TX

pontas de impacto 16 mm para parafusos Torx®



Ø	Ø	L	€		
mm	mm	mm			
T55	16	50	26,00	2	007270355
T60	16	50	26,00	2	007270360
T70	16	50	26,00	2	007270370

## 727/ES16XZN

bits de impacto para parafusos cabeça XZN®, encabadouro 16 mm



Ø	Ø	L	€		
mm	mm	mm			
M6	16	60	31,00	2	007270606
M8	16	60	31,00	2	007270608
M10	16	60	31,00	2	007270610
M12	16	60	31,00	2	007270612
M14	16	60	31,00	2	007270614
M16	16	60	31,00	2	007270616
M18	16	60	43,00	2	007270618





## 727PI/22

chave porta-pontas de impacto 22 mm para os artigos 727/ES22 e 727/ES22TX

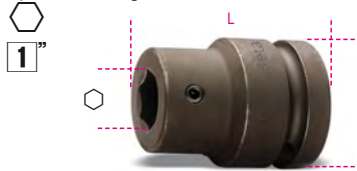

Ø mm	L mm	Ø mm	€	Unidade	Artigo
54	70	22	78,50	2	007270022

## 727/ES22

pontas de impacto sextavados 22 mm



mm	Ø mm	L mm	€	Unidade	Artigo
19	22	50	22,20	2	007270219
22	22	50	22,20	2	007270222
24	22	50	24,50	2	007270224
27	22	50	27,50	2	007270227
30	22	50	32,50	2	007270230
32	22	50	35,50	2	007270232

## 727/ES22TX

pontas de impacto 22 mm para parafusos Torx®



T	Ø mm	L mm	€	Unidade	Artigo
T80	22	60	36,00	2	007270480
T90	22	60	36,00	2	007270490
T100	22	60	36,00	2	007270500

## 727/C16

jogo com 12 pontas de impacto e 4 acessórios



Artigo	€	Unidade	Artigo
727/C16	493,00	1	007270900

- 727PI/16
  - 727/ES16 14-17-19 mm
  - 727/ES16TX T55-T60-T70
  - 727PI/22
  - 727/ES22 22-24-27 mm
  - 727/ES22TX T80-T90-T100
  - 96BPC 3-4 mm
- 335x145x60 mm - 3,6 kg

## 727PI/32

chave porta-pontas de impacto 32 mm para os artigos 727/ES22 e 727/ES22TX

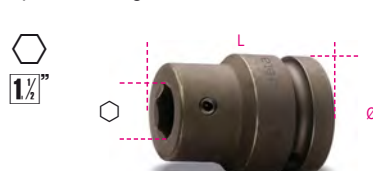

Ø mm	L mm	Ø mm	€	Unidade	Artigo
86	66	32	196,00	1	007270032

## 727/ES32

pontas de impacto sextavados 32 mm

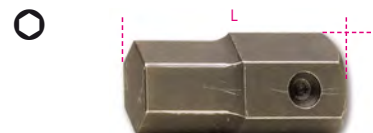

mm	Ø mm	L mm	€	Unidade	Artigo
19	32	44	50,50	2	007270519
22	32	44	50,50	2	007270522
24	32	44	50,50	2	007270524
27	32	44	50,50	2	007270527
30	32	44	50,50	2	007270530
32	32	44	50,50	2	007270532
36	32	44	56,50	2	007270536

## 728

chaves de impacto série normal



UNI/ISO 2725 DIN 3129

Ø mm	Ø mm	L mm	Ø1 mm	€	Unidade	Artigo
17	30,0	51	44	29,00	2	007280017
18	31,0	51	44	29,00	2	007280018
19	32,5	51	44	29,00	2	007280019
21	35,0	51	44	29,00	2	007280021
22	36,0	51	44	29,00	2	007280022
23	37,5	51	44	29,50	2	007280023
24	38,5	51	44	29,50	2	007280024
27	42,5	53	44	29,50	2	007280027
28	44,0	53	44	30,00	2	007280028
30	46,0	53	44	31,00	2	007280030
32	48,5	57	44	32,50	2	007280032
33	50,0	57	44	35,00	2	007280033
34	51,0	57	44	35,00	2	007280034
35	52,5	57	44	36,00	2	007280035
36	53,5	57	44	37,00	2	007280036
38	56,0	57	44	41,50	1	007280038
40	58,5	58	44	44,00	1	007280040
41	60,0	58	44	44,50	1	007280041
44	64,0	62	44	48,50	1	007280044
45	65,0	62	44	52,50	1	007280045
46	66,0	62	44	53,00	1	007280046
50	71,0	68	54	62,50	1	007280050
55	77,5	71	54	69,50	1	007280055
60	83,0	73	54	79,50	1	007280060
65	88,0	78	54	88,00	1	007280065

## 728/C10

jogo com 10 chaves de impacto



Artigo	€	Unidade	Artigo
728/C10	387,00	1	007280910

17-19-22-24-27-30  
32-36-41-46 mm

275x120x65 mm - 5,7 kg

## 728B

chaves de impacto bisextavadas



UNI/ISO 2725 DIN 3129

Ø mm	Ø mm	L mm	Ø1 mm	€	Unidade	Artigo
17	28,5	50	38	29,00	2	007280117
19	30	52	38	29,00	2	007280119
21	32	52	38	29,00	2	007280121
22	34	52	38	29,00	2	007280122
23	35	52	38	29,50	2	007280123
24	36	52	38	29,50	2	007280124
27	40	52	40	29,50	2	007280127
29	42	52	42	30,50	2	007280129
30	44	52	44	31,00	2	007280130
32	48	52	44	32,50	2	007280132
33	50	56	44	35,00	2	007280133
34	51	56	44	35,00	2	007280134
35	52	56	44	36,00	2	007280135
36	53,5	56	44	37,00	2	007280136
38	56	56	44	41,50	1	007280138
41	60	58	44	44,50	1	007280141
46	67	63	44	53,00	1	007280146

## 728B/C10

10 chaves de impacto bisextavadas



Artigo	€	Unidade	Artigo
728B/C10	387,00	1	007280930

17-19-22-24-27  
30-32-36-41-46 mm

275x120x65 mm - 5,7 kg



## 728AS

chaves de impacto, série normal



3/4"	Ø	L	Ø1	€		
mm	mm	mm	mm			
3/4	32,0	51	41	29,00	1	007280219
13/16	35,0	51	41	29,50	1	007280221
7/8	36,0	51	41	29,50	1	007280222
15/16	38,5	51	41	29,50	1	007280224
1	40,0	53	41	30,00	1	007280225
1.1/16	42,5	53	44	32,00	1	007280227
1.1/8	44,0	53	44	32,50	1	007280230
1.1/4	48,5	57	44	33,50	1	007280232
1.5/16	50,0	57	44	35,00	1	007280233
1.7/16	53,5	57	44	37,00	1	007280236
1.1/2	56,0	57	44	41,00	1	007280238
1.5/8	60,0	58	44	44,50	1	007280241

## 728FTX

chave de impacto para parafusos de perfil Torx®



3/4"	Ø	L	Ø1	€		
mm	mm	mm	mm			
E20	28,5	50	44	38,50	2	007280420
E22	30,0	50	44	38,50	2	007280422
E24	32,5	50	44	38,50	2	007280424

## 728ME

chaves de impacto para parafusos sextavados



3/4"	Ø	L	L1	€		
mm	mm	mm	mm			
12	44	100	67	34,00	3	007280712
14	44	100	67	37,50	3	007280714
17	44	100	67	37,50	3	007280717
19	44	100	67	37,50	3	007280719
22	44	100	67	44,00	3	007280722
24	44	100	67	44,00	3	007280724

## 728ME/C6

6 chaves de impacto para parafusos sextavados



728ME/C6	278,00	1	007280906
12-14-17-19-22-24 mm			

335x145x60 mm - 4,0 kg

## 728L

chaves de impacto, série longa



3/4"	D	L	Ø1	€		
mm	mm	mm	mm			
17	30	90	44	46,00	2	007280317
19	32,5	90	44	46,00	2	007280319
21	35,0	90	44	46,00	2	007280321
22	36,0	90	44	46,00	2	007280322
24	38,5	90	44	46,00	2	007280324
26	41,0	90	44	46,00	2	007280326
27	42,5	90	44	46,00	2	007280327
30	46,0	90	44	47,50	2	007280330
32	48,5	90	44	50,50	2	007280332
33	50,0	90	44	53,50	1	007280333
34	51,0	90	44	57,00	1	007280334
36	53,5	90	44	59,00	1	007280336
38	56,0	90	44	69,00	1	007280338
41	60,0	90	44	70,50	1	007280341
44	64,0	90	44	81,00	1	007280344
46	66,0	90	44	81,00	1	007280346
50	71,0	90	44	96,50	1	007280350
55	77,5	100	54	127,00	1	007280355



728L/S3	157,00	1	007280393
30-32-36 mm			

## 728LS

chaves de impacto série longa com paredes finas



3/4"	D	L	Ø1	€		
mm	mm	mm	mm			
17	28,0	100	43	52,00	2	007280517
19	30,5	100	43	52,00	2	007280519
22	34,3	100	43	53,00	2	007280522
24	36,8	100	43	53,00	2	007280524
27	40,5	100	43	53,00	2	007280527
30	44,3	100	43	53,00	2	007280530
32	46,8	100	43	57,00	2	007280532
33	48,0	100	43	58,50	2	007280533
36	51,8	100	43	68,50	1	007280536

## 728LQ

chaves de impacto, série longa

(para porcas de rodas ISUZU)



3/4"	L	Ø	Ø1	€		
mm	mm	mm	mm			
19	90	35	43,5	46,50	1	007280619
21	90	42	43,5	46,50	1	007280621

## 728/15

redução quadra fêmea de 3/4" para quadra macho de 1/2"



L	Ø	3/4"	1/2"	€		
mm	mm					
58	38			36,00	2	007280810



Aplique sempre uma força de aperto regular e progressiva, a fim de evitar a ruptura do material e de se proteger de um possível acidente

## 728/16

adaptador quadra fêmea de 3/4" para quadra macho de 1"



L	Ø	3/4"	1"	€		
mm	mm					
62	44			43,50	2	007280813

## 728/21

extensões com quadras macho e fêmea de 3/4"



L	Ø	3/4"	3/4"	€		
mm	mm					
175	44			53,50	2	007280815

## 728/22

extensões com quadras macho e fêmea de 3/4"



L	Ø	3/4"	3/4"	€		
mm	mm					
250	44			62,00	2	007280825

## 728/22L

extensões com quadras macho e fêmea de 3/4"



L	Ø	3/4"	3/4"	€		
mm	mm					
330	44			79,50	1	007280826

## 728/25

cardan com quadras macho e fêmea de 3/4"



L	Ø	3/4"	3/4"	€		
mm	mm					
107,5	44			105,00	1	007280830

## 728/OR - 728/SP

anéis em borracha e cavilhas de fixação para chaves de impacto e acessórios

3/4"

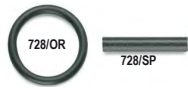

	728	728FTX	€		
	mm	mm			
728/OR-15	728/15		2,19	5	007280925
728/OR	17+46	E20+E24	2,33	10	007280926
728/SP	17+46	E20+E24	3,05	10	007280916

## 729

chaves de impacto série normal



UNI/ISO 2725 DIN 3129

mm	D mm	L mm	Ø1 mm	€		
24	41,5	58	54	46,50	1	007290024
27	45,0	60	54	46,50	1	007290027
30	49,0	62	54	46,50	1	007290030
32	51,5	63	54	47,50	1	007290032
33	52,5	63	54	47,50	1	007290033
34	54,0	63	54	47,50	1	007290034
36	56,5	66	54	47,50	1	007290036
38	59,0	66	54	57,50	1	007290038
41	62,5	68	54	58,50	1	007290041
46	69,0	72	54	65,50	1	007290046
50	74,0	76	54	81,00	1	007290050
55	80,0	84	54	86,50	1	007290055
60	86,5	88	54	105,00	1	007290060
65	92,5	92	54	120,00	1	007290065
70	99,0	96	54	154,00	1	007290070
75	105,0	102	63	179,00	1	007290075
80	111,5	102	63	193,00	1	007290080

## 729L

chaves de impacto série longa



mm	D mm	L mm	Ø1 mm	€		
24	41,5	108	54	82,50	1	007290324
27	45,0	108	54	82,50	1	007290327
30	49,0	108	54	82,50	1	007290330
32	51,5	108	54	82,50	1	007290332
33	52,2	108	54	83,50	1	007290333
34	54,0	108	54	83,50	1	007290334
36	56,5	108	54	83,50	1	007290336
41	62,5	108	54	99,50	1	007290341
46	69,0	108	54	115,00	1	007290346
50	74,0	108	54	129,00	1	007290350
55	80,0	108	54	155,00	1	007290355
60	86,5	108	54	167,00	1	007290360
65	92,5	108	54	202,00	1	007290365
70	99,0	108	54	229,00	1	007290370
75	105,0	108	63	259,00	1	007290375
80	111,5	108	63	272,00	1	007290380

## 729LS

chaves de impacto série longa com paredes finas



mm	D mm	L mm	Ø1 mm	€		
22	36,0	108	53	82,50	1	007290522
24	38,5	108	53	82,50	1	007290524
27	46,0	108	53	82,50	1	007290527
30	50,0	108	53	87,50	1	007290530
32	50,0	108	53	87,50	1	007290532
33	52,0	108	53	87,50	1	007290533
36	56,0	108	53	87,50	1	007290536

## 729T

barra de torção de impacto para cubos de roda



mm	L mm	€			
24	350	300	161,00	1	007290724
27	450	300	161,00	1	007290757
30	500	300	162,00	1	007290730
32	450	300	165,00	1	007290732
32	600	300	165,00	1	007290762
33	600	300	173,00	1	007290763
36	600	300	184,00	1	007290736

## 729/15

redução quadra fêmea de 1" para quadra macho de 3/4"



L mm	Ø mm	□	■	€		
66,5	54	1	3/4	55,50	1	007290810



Aplique sempre uma força de aperto regular e progressiva, a fim de evitar a ruptura do material e de se proteger de um possível acidente

## 729/16

redução quadra fêmea de 1" para quadra macho de 1.1/2"



L mm	Ø mm	□	■	€		
88	54,0	1	1.1/2	90,50	1	007290813

## 729/21

extensões com quadras macho e fêmea de 1"



L mm	Ø mm	€		
175	54	84,50	1	007290815

## 729/21L

extensões, com quadras macho e fêmea de 1"



L mm	Ø mm	€		
250	54	104,00	1	007290826

## 729/22

extensões com quadras macho e fêmea de 1"



L mm	Ø mm	€		
330	54	121,00	1	007290825

## 729/25

cardan com quadras macho e fêmea de 1"



L mm	Ø mm	€		
130	54	175,00	1	007290830

## 729/OR... - 729/SP...

anéis em borracha e cavilhas de fixação para chaves de impacto e acessórios

3/4"

1"

1 1/2"

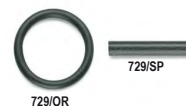

	728	729-730	€		
	mm	mm			
729/OR1	50+60	24+70	2,39	5	007290927
729/OR2		75+125	3,70	5	007290928
729/SP1	50+60	24+70	2,25	5	007290917
729/SP2		75+125	3,70	5	007290918



## 730

chaves de impacto série normal



UNI/ISO 2725 DIN 3129

Ø	D	L	Ø1	€	1	007300050
mm	mm	mm	mm			
50	81	87	84	241,00	1	007300050
55	88	90	86	247,00	1	007300055
60	94	95	86	273,00	1	007300060
65	100	100	86	299,00	1	007300065
70	106	105	86	354,00	1	007300070
75	113	110	86	410,00	1	007300075
80	119	115	86	469,00	1	007300080
85	125	120	86	520,00	1	007300085
90	132	125	86	595,00	1	007300090
95	138	125	96	690,00	1	007300095
100	144	130	96	800,00	1	007300100
105	150	135	96	895,00	1	007300105
110	157	140	96	970,00	1	007300110
115	163	140	96	1.050,00	1	007300115
120	169	145	96	1.170,00	1	007300120
125	175	145	96	1.220,00	1	007300125

## 730L

chaves de impacto sextavadas, série longa



Ø	L	Ø1	€	1	007300350	
mm	mm	mm				
50	81	135	86	385,00	1	007300350
55	87	140	86	395,00	1	007300355
60	93	150	86	438,00	1	007300360
65	97	150	86	479,00	1	007300365
70	105	160	86	570,00	1	007300370
75	110	170	86	660,00	1	007300375
80	116	170	86	755,00	1	007300380
85	125	170	86	835,00	1	007300385
90	130	170	86	950,00	1	007300390
95	137	180	95	1.110,00	1	007300395
100	144	190	95	1.280,00	1	007300400
105	150	190	95	1.430,00	1	007300405
110	156	200	95	1.550,00	1	007300410
115	160	200	95	1.670,00	1	007300415
120	168	210	95	1.870,00	1	007300420

## 730/15

adaptadores



L	Ø	€	1	007300810
mm	mm			
105	84,0	189,00	1	007300810



Aplique sempre uma força de aperto regular e progressiva, a fim de evitar a ruptura do material e de se proteger de um possível acidente

## 730/21

extensões, com quadras macho e fêmea de 1.1/2"



L	Ø	€	1	007300822
mm	mm			
250	86	690,00	1	007300822

## 730/25

cardan, com quadras macho e fêmea de 1.1/2"



L	Ø	€	1	007300830
mm	mm			
150	86	725,00	1	007300830

## 733/15

adaptadores



L	Ø	€	1	007330810
mm	mm			
156	127	665,00	1	007330810



## BITS

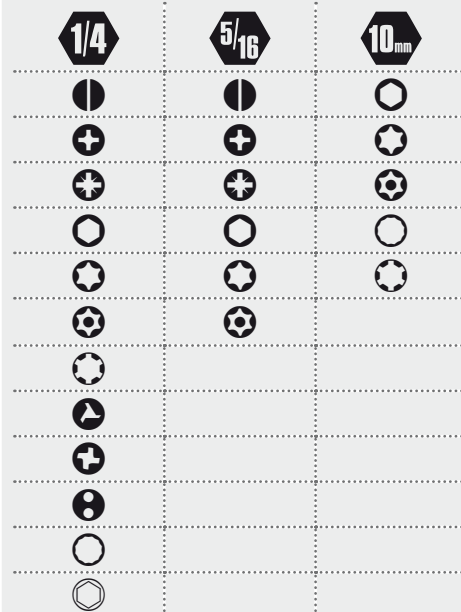

### ISO 1173-C 6,3



assento de mola de retenção

### ISO 1173-E 6,3



ranhura de esfera de retenção

## 851

porta pontas magnético com punho



L1 mm	L mm	€	2	008510165
45	165	17,60	2	008510165
125	245	20,40	2	008510245

## 851SR

porta-pontas de desengate rápido com punho



L	L1	€	2	008510001
mm	mm			
230	110	24,30	2	008510001

## 852

porta-bits, com cabo articulado em T

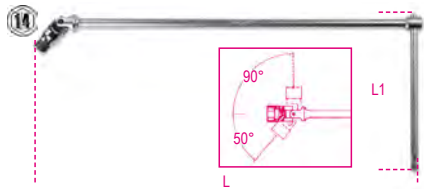

Ø	L	L1	€	U	U
1/4"	400	160	53,00	2	008520006

## 855P

punho porta-pontas com roquete reversível, articulado, com 7 bits integrados



L	L1	€	U	U
240	100	80,00	1	008550010

860PH	PH1 - PH2
860PZ	PZ1 - PZ2
860LP	LP 0,8x5,5 mm
860PE	4 - 5 mm

## 860LP

bits para parafusos ranhurados, coloridos



ISO 2351-1  
ISO 1173 C 6,3

SxA	L	€	U	U
0,5x3	25	2,09	5	008600005
0,6x4,5	25	2,09	5	008600010
0,8x5,5	25	2,09	5	008600015
1x5,5	25	2,09	5	008600020
1,2x6,5	25	2,09	5	008600025

## 860PH

bits para parafusos Phillips®, coloridos



ISO 2351-2  
ISO 1173 C 6,3

PH	L	€	U	U
0	25	2,09	5	008600220
1	25	2,09	5	008600225
2	25	2,09	5	008600230
3	25	2,09	5	008600245
4	25	3,00	5	008600250

## 860PZ

bits para parafusos Pozidriv® - Supadriv®, coloridos



ISO 2351-2  
ISO 1173 C 6,3

PZ	L	€	U	U
1	25	2,09	5	008600320
2	25	2,09	5	008600325
3	25	2,09	5	008600330
4	25	3,00	5	008600335

## 860PE

bits sextavados para aparafusadoras eléctricas, coloridos



ISO 2351-3  
ISO 1173 C 6,3

mm	L	€	U	U
2	25	2,22	5	008600101
2,5	25	2,22	5	008600102
3	25	2,22	5	008600103
4	25	2,22	5	008600104
5	25	2,22	5	008600105
6	25	2,22	5	008600106
8	25	2,79	5	008600108
10	25	2,79	5	008600110

## 860TX

bits para parafusos Torx®, coloridos



ISO 1173 C 6,3

Ø	L	€	U	U
T6	25	2,79	5	008600704
T7	25	2,79	5	008600705
T8	25	2,79	5	008600710
T9	25	2,79	5	008600715
T10	25	2,22	5	008600720
T15	25	2,22	5	008600725
T20	25	2,22	5	008600730
T25	25	2,22	5	008600735
T27	25	2,22	5	008600740
T30	25	2,22	5	008600745
T40	25	2,22	5	008600750

## 860RTX

bits para parafusos invioláveis Torx®, coloridos



ISO 1173 C 6,3

Ø	L	€	U	U
T9	25	3,00	5	008600550
T10	25	3,00	5	008600555
T15	25	3,00	5	008600560
T20	25	3,00	5	008600565
T25	25	3,00	5	008600570
T27	25	3,00	5	008600575
T30	25	3,00	5	008600580
T40	25	3,00	5	008600585

## 860/55

chave de bits reversível



L	Ø	€	U	U
100	1/4	35,50	3	008600870

## 860/58

roquete com punho rotativo

- O bit encaixa em ambos os lados, para aparafusar ou desaparafusar
- Punho bi-material



L	Ø	A	€	U	U
860/58	126	1/4"	27	15	82,00

## 860/C27

jogo de 25 bits, 1 conector e 1 roquete reversível em estojo de plástico



860/C27	€	U	U
	97,00	1	008600880

860/55	100 mm
860LP	0,5x3-1,0x5,5-1,2x6,5 mm
860PH	PH1-PH2(x2)-PH3
860PZ	PZ1-PZ2(x2)-PZ3
860PE	2-2,5-3-4-5-6 mm
860TX	T6-T8-T10-T15-T20-T25-T30-T40
892/0	1/4" ■ 1/4"



## 860/C38P

1 punho porta-pontas com roquete reversível,  
27 bits, 8 chaves de caixa sextavadas e 2  
acessórios  
em estojo de metal com tabuleiro maleável

porta-pontas com roquete reversível  
tampa porta-bits  
barra de extensão amovível de montagem rápida



860/C38P € 210,00 1 008600878

	860LP	0,6x4,5-0,8x5,5-1,0x5,5-1,2x6,5 mm
	860PE	2-2,5-3-4-5 mm
	860PH	PH1-PH2-PH3
	860PZ	PZ1-PZ2-PZ3
	860TX	T10-T15-T20-T25-T30-T40
	900	5-5,5-6-7-8-9-10-13 mm
	892/0	● 1/4 ■ 1/4
	892/3	● 1/4 ■ 1/4
	855P	240 mm
270x120x45 mm		

## 861LP

pontas para parafusos de fenda



ISO 2351-1

ISO 1173 C 6,3

SxA mm	L mm	€	10	008610005
0,5x3	25	1,35	10	008610005
0,6x4	25	1,35	10	008610007
0,6x4,5	25	1,35	10	008610010
0,8x5,5	25	1,35	10	008610015
1x5,5	25	1,35	10	008610020
1,2x6,5	25	1,35	10	008610025
1,2x8	25	2,59	10	008610028
1,6x8	25	2,59	10	008610030

## 861PH

pontas para parafusos de perfil Phillips(R)



ISO 2351-2

ISO 1173 C 6,3

PH	L mm	€	10	008610200
0	25	1,33	10	008610200
1	25	1,33	10	008610205
2	25	1,33	10	008610210
2L	50	2,59	10	008610213
3	25	1,33	10	008610215
4	25	3,55	10	008610220

## 861PH/C

pontas para parafusos de perfil Phillips®



ISO 2351-2

ISO 1173 C 6,3

PH	L mm	€	200	008610250
0	25	1,01	200	008610250
1	25	1,01	200	008610255
2	25	1,01	200	008610260
2L	50	1,95	100	008610263
3	25	1,01	200	008610265
4	25	2,63	100	008610270

## 861PZ

pontas para parafusos  
de perfil Pozidriv(R) - Supadriv(R)



ISO 2351-2

ISO 1173 C 6,3

PZ	L mm	€	10	008610300
1	25	1,33	10	008610300
2	25	1,33	10	008610305
2L	50	2,56	10	008610308
3	25	1,33	10	008610310
4	25	3,55	10	008610315

## 861PZ/C

pontas para parafusos  
de perfil Pozidriv® - Supadriv®



ISO 2351-2

ISO 1173 C 6,3

PZ	L mm	€	200	008610350
1	25	1,01	200	008610350
2	25	1,01	200	008610355
2L	50	1,95	100	008610358
3	25	1,01	200	008610360
4	25	2,59	100	008610365

## 861PE

pontas macho hexagonal



ISO 2351-3

ISO 1173 C 6,3

mm	L mm	€	10	008610100
2	25	1,43	10	008610100
2,5	25	1,43	10	008610105
3	25	1,43	10	008610110
4	25	1,43	10	008610115
5	25	1,43	10	008610120
6	25	1,43	10	008610125
8	25	2,15	10	008610130
10	25	2,84	10	008610135

## 861TX

pontas para parafusos  
de perfil Torx®



ISO 1173 C 6,3

T	L mm	€	10	008610399
T5	25	1,89	10	008610399
T6	25	1,89	10	008610400
T7	25	1,89	10	008610405
T8	25	1,89	10	008610410
T9	25	1,89	10	008610415
T10	25	1,49	10	008610420
T15	25	1,49	10	008610425
T20	25	1,49	10	008610430
T25	25	1,49	10	008610435
T27	25	1,49	10	008610440
T30	25	1,49	10	008610445
T40	25	1,49	10	008610450

## 861TX/C

pontas para parafusos  
de perfil Torx®



ISO 1173 C 6,3

T	L mm	€	200	008610470
T10	25	1,15	200	008610470
T15	25	1,15	200	008610475
T20	25	1,15	200	008610480
T25	25	1,15	200	008610485
T27	25	1,15	200	008610490
T30	25	1,15	200	008610495
T40	25	1,15	200	008610499

## 861RTX

pontas para parafusos  
de perfil Tamper Resistant Torx(R)

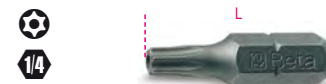

ISO 1173 C 6,3

T	L mm	€	10	008610537
T6	25	2,79	10	008610537
T7	25	2,79	10	008610538
T8	25	2,79	10	008610540
T9	25	2,79	10	008610500
T10	25	2,79	10	008610505
T15	25	2,79	10	008610510
T20	25	2,79	10	008610515
T25	25	2,79	10	008610520
T27	25	2,79	10	008610525
T30	25	2,79	10	008610530
T40	25	2,79	10	008610535
T45	25	5,50	10	008610539





## 861TRW

pontas para parafusos de perfil Tri-Wing(R)



ISO 1173 C 6,3

GR	L mm	€		
1	25	2,37	10	008610601
2	25	2,37	10	008610602
3	25	2,37	10	008610603
4	25	2,37	10	008610604
5	25	2,37	10	008610605
6	25	3,45	10	008610606

## 861TQS

pontas para parafusos de perfil Torq-Set(R)



ISO 1173 C 6,3

GR	L mm	€		
0	25	2,37	10	008610620
1	25	2,37	10	008610621
2	25	2,37	10	008610622
3	25	2,37	10	008610623
4	25	2,37	10	008610624
5	25	2,37	10	008610625
6	25	2,37	10	008610626
8	25	2,37	10	008610628
10	25	2,37	10	008610630

## 861SP

pontas para parafusos de perfil Spanner



ISO 1173 C 6,3

SP	D mm	L mm	€		
4	1,5	25	1,95	10	008610650
6	2,4	25	1,95	10	008610653
8	2,8	25	1,95	10	008610656
10	3,3	25	1,95	10	008610658
12	3,9	25	1,95	10	008610660

## 1483KV-PT/S7



1483KV PT/S7

180



## 861PHZ/A10

jogo de 10 bits com porta-bits magnético, em estojo de bolso



861PHZ/A10

€ 32,50

1 008610810

861PH	PH1 PH2 PH3	1 3 1
861PZ	PZ1 PZ2 PZ3	1 3 1
882M1	○ 1/4 ● 1/4	

## 861PE/A10

jogo de 10 bits com porta-bits magnético, em estojo de bolso



861PE/A10

€ 34,00

1 008610820

861PE	2 - 2,5 3 - 4 - 5 6 - 8 mm	1 2 1
882M1	○ 1/4 ● 1/4	

## 861TX/A10

jogo de 10 bits com porta-bits magnético, em estojo de bolso



861TX/A10

€ 35,00

1 008610870

861TX	T7 - T8 - T9 - T10 - T15 - T20 T25 - T27 - T30 - T40	1
882M1	○ 1/4 ● 1/4	

## 861MIX/A10

jogo de 10 bits com porta-bits magnético, em estojo de bolso



861MIX/A10

€ 32,50

1 008610800

861LP	0,5x3 - 1x5,5 x 1,2x6,5 mm	1
861PH	PH1 PH2 PH3	1 2 1
861PZ	PZ1 - PZ2 - PZ3	1
882M1	○ 1/4 ● 1/4	

## 861MIX/A31

jogo de 30 bits com porta-bits magnético de desengate rápido, em estojo de bolso



861MIX/A31

€ 80,00

1 008610802

861LP	0,5x3 - 0,6x4,5 - 0,8x5,5 - 1,0x5,5 - 1,2x6,5 mm	
861PH	PH0 - PH1 - PH2 - PH3 - PH4	
861PE	2 - 2,5 - 3 - 4 - 5 - 6 8 - 10 mm	
861PZ	PZ1 - PZ2 - PZ3 - PZ4	
861RTX	T9 - T10 - T15 - T20 - T25 T27 - T30 - T40	
882MSR 50	○ 1/4 ● 1/4	



## 861/C61P

61 pontas e 1 porta-pontas magnético de desengate rápido com punho

1/4



861/C61P € 182,00 1 008610978

- 861LP 0,5x3 - 0,6x4,5 - 0,8x5,5 - 1,0x5,5  
1,2x6,5 - 1,2x8 - 1,6x8 mm
  - 861PE 2 - 2,5 - 3 - 4 - 5 - 6 - 8 - 10 mm
  - 861PH PH0 - PH1 - PH2 - PH3
  - 861PZ PZ1 - PZ2 - PZ3
  - 861TX T6 - T7 - T8 - T9 - T10 - T15  
T20 - T25 - T27 - T30 - T40
  - 861RTX T9 - T10 - T15 - T20 - T25  
T27 - T30 - T40
  - 861TRW 1 - 2 - 3 - 4 - 5 - 6
  - 861TQS 0 - 1 - 2 - 3 - 4 - 5 - 6 - 8 - 10
  - 861SP 4 - 6 - 8 - 10 - 12
  - 851SR 1/4"
- 270x120x45 mm - 975 g

## 862LP

pontas para parafusos de perfil de fenda



ISO 2351-1

ISO 1173 E 6,3

SxA mm	L mm	€	5	10
0,5x3	50	3,90	5	008620005
0,6x4,5	50	3,90	5	008620010
0,8x5,5	50	3,90	5	008620015
1x5,5	50	3,90	5	008620020
1,2x6,5	50	3,90	5	008620025
1,2x8	50	4,80	5	008620030
1,6x8	50	4,80	5	008620035

## 862PH

pontas para parafusos de perfil Phillips®



ISO 2351-2

ISO 1173 E 6,3

PH	L mm	€	5	10
1	50	3,90	5	008620200
2	50	3,90	5	008620205
3	50	3,90	5	008620210

## 862PH/L

pontas para parafusos de perfil Phillips®



ISO 2351-2

ISO 1173 E 6,3

PH	L mm	€	5	10
1	70	7,20	5	008620230
2	70	7,20	5	008620232
3	70	7,20	5	008620234

## 862PH-XL

Pontas para parafusos de perfil Phillips®



ISO 2351-2 ISO 1173 E 6,3

PH	L mm	€	5	10
1	100	7,40	5	008620250
2	100	7,40	5	008620252
3	100	7,40	5	008620254

## 862PZ

pontas para parafusos de perfil Pozidriv® - Supadriv®



ISO 2351-2

ISO 1173 E 6,3

PZ	L mm	€	5	10
1	50	4,00	5	008620300
2	50	4,00	5	008620305
3	50	4,00	5	008620310

## 862PE

pontas macho hexagonal



ISO 2351-3

ISO 1173 E 6,3

mm	L mm	€	5	10
3	50	4,00	5	008620103
4	50	4,00	5	008620104
5	50	4,00	5	008620105
6	50	4,00	5	008620106
8	50	5,50	5	008620108

## 862TX

pontas para parafusos de perfil Torx®



ISO 1173 E 6,3

T	L mm	€	5	10
T6	50	5,40	5	008620506
T7	50	5,40	5	008620507
T8	50	5,40	5	008620508
T9	50	5,40	5	008620509
T10	50	5,40	5	008620510
T15	50	5,40	5	008620515
T20	50	5,40	5	008620520
T25	50	5,40	5	008620525
T27	50	5,40	5	008620527
T30	50	5,40	5	008620530
T40	50	5,40	5	008620540

## 862TX/L

pontas para parafusos de perfil Torx®



ISO 1173 E 6,3

T	L mm	€	5	10
T6	70	5,80	5	008620556
T7	70	5,80	5	008620557
T8	70	5,80	5	008620558
T9	70	5,80	5	008620559
T10	70	5,80	5	008620560
T15	70	5,80	5	008620565
T20	70	5,80	5	008620570
T25	70	5,80	5	008620575
T27	70	5,80	5	008620577
T30	70	5,80	5	008620580
T40	70	5,80	5	008620590

## 862TX-XL

Pontas para parafusos de perfil Torx®



ISO 1173 E 6,3

T	L mm	€	5	10
T9	100	6,40	5	008620659
T10	100	6,40	5	008620660
T15	100	6,40	5	008620665
T20	100	6,40	5	008620670
T25	100	6,40	5	008620675
T27	100	6,40	5	008620677
T30	100	6,40	5	008620680
T40	100	6,40	5	008620690



### 862F

pontas para chaves de caixa magnéticas



ISO 1173 E 6,3

mm	L mm	Ø mm	€	📦	🖨️
5,5	65	11	7,30	5	008620405
6	65	11	7,30	5	008620406
7	65	11	7,30	5	008620407
8	65	13	7,30	5	008620408
10	65	15	8,00	5	008620410
12	65	18	8,80	5	008620412
13	65	18	9,30	5	008620413

### 862F/A7

Jogo de 7 bits sextavados magnéticos com chaves de caixa sextavadas em estojo de plástico



862F/A7 € 55,50 📦 1 🖨️ 008620950

862F 5,5-6-7-8-10-12-13 mm

### 862XP/A16

16 pontas de impacto em estojo de bolso



862XP/A16 € 73,50 📦 1 🖨️ 008620960

- ⊕ PH2(x2)-PH3
- ⊕ PZ2(x2)-PZ3
- ⊖ T20-T25(x2)
- ⊖ T30(x2)-T40(x2)
- 4-5-6 mm

### 866LP

pontas para parafusos de fendas



ISO 2351-1  
ISO 1173 C 8

SxA mm	L mm	€	📦	🖨️
1x5,5	41	4,00	10	008660005
1,2x6,5	41	4,00	10	008660010
1,6x8	41	4,00	10	008660015
1,6x10	41	5,50	10	008660020
2x12	41	6,80	10	008660025

### 866PH

pontas para parafusos de perfil Phillips®



ISO 2351-2  
ISO 1173 C 8

PH	L mm	€	📦	🖨️
1	32	3,25	10	008660200
2	32	3,25	10	008660205
3	32	3,25	10	008660210
4	38	4,85	10	008660215

### 866PZ

pontas para parafusos de perfil Pozidriv® - Supadriv®



ISO 2351-2  
ISO 1173 C 8

PZ	L mm	€	📦	🖨️
1	32	3,40	10	008660300
2	32	3,40	10	008660305
3	32	3,40	10	008660310
4	38	5,10	10	008660315

### 866PE

pontas macho hexagonal



ISO 2351-3  
ISO 1173 C 8

mm	L mm	€	📦	🖨️
3	30	2,79	10	008660100
4	30	2,79	10	008660105
5	30	2,79	10	008660110
6	30	2,79	10	008660115
7	30	2,79	10	008660117
8	30	2,79	10	008660120
10	30	3,90	10	008660125
12	30	5,50	10	008660132
14	30	7,00	10	008660134

### 866TX

pontas para parafusos de perfil Torx®



ISO 1173 C 8

T	L mm	€	📦	🖨️
T20	30	3,50	10	008660400
T25	30	3,50	10	008660405
T27	30	3,50	10	008660410
T30	30	3,50	10	008660415
T40	30	3,50	10	008660420
T45	30	3,50	10	008660425
T50	30	3,50	10	008660430
T55	30	5,10	10	008660435
T60	30	6,80	10	008660440
T70	30	7,50	10	008660445

### 867PE

pontas macho hexagonal



mm	L mm	€	📦	🖨️
4	30	1,83	5	008670104
5	30	1,83	5	008670105
6	30	1,83	5	008670106
7	30	1,83	5	008670107
8	30	1,83	5	008670108
10	30	1,83	5	008670110
12	30	2,72	5	008670112

### 867PE/L

pontas hexagonais



mm	L mm	€	📦	🖨️
4	75	3,40	5	008670154
5	75	3,40	5	008670155
6	75	3,40	5	008670156
7	75	3,40	5	008670157
8	75	3,40	5	008670158
10	75	3,40	5	008670160
12	75	4,75	5	008670162

### 867XZN

pontas para parafusos de perfil XZN(R)



M	L mm	€	📦	🖨️
M4	30	2,29	5	008670204
M5	30	2,29	5	008670205
M6	30	2,29	5	008670206
M8	30	2,29	5	008670208
M10	30	2,29	5	008670210
M12	30	3,40	5	008670212



## 867XZN/L

pontas com perfil XZN(R)



Ø	L mm	€	5	10
M5	75	3,70	5	008670255
M6	75	3,70	5	008670256
M8	75	3,70	5	008670258
M10	75	3,70	5	008670260
M12	75	5,10	5	008670262

## 867TX

pontas para parafusos de perfil Torx(R)



Ø	L mm	€	5	10
T20	30	1,83	5	008670400
T25	30	1,83	5	008670405
T30	30	1,83	5	008670410
T40	30	1,83	5	008670415
T45	30	1,83	5	008670420
T50	30	1,83	5	008670425
T55	30	1,83	5	008670430

## 867TX/L

pontas para parafusos de perfil Torx(R)



Ø	L mm	€	5	10
T20	75	2,99	5	008670450
T25	75	2,99	5	008670455
T30	75	2,99	5	008670460
T40	75	2,99	5	008670465
T45	75	2,99	5	008670470
T50	75	2,99	5	008670475
T55	75	2,99	5	008670480

## 867RTX

pontas para parafusos de perfil Tamper Resistant Torx(R)



Ø	L mm	€	5	10
T20	30	2,04	5	008670500
T25	30	2,04	5	008670505
T30	30	2,04	5	008670510
T40	30	2,04	5	008670515
T45	30	2,04	5	008670520
T50	30	2,04	5	008670525
T55	30	2,04	5	008670530

## 867RTX/L

pontas para parafusos de perfil Tamper Resistant Torx®



Ø	L mm	€	5	10
T20	75	3,40	5	008670550
T25	75	3,40	5	008670555
T30	75	3,40	5	008670560
T40	75	3,40	5	008670565
T45	75	3,40	5	008670570
T50	75	3,40	5	008670575
T55	75	3,40	5	008670580

## 867RIBE

pontas para parafusos RIBE®



Ø	L mm	€	5	10
M5	30	2,09	5	008670705
M6	30	2,09	5	008670706
M7	30	2,09	5	008670707
M8	30	2,09	5	008670708
M9	30	2,09	5	008670709
M10	30	2,09	5	008670710
M11	30	3,05	5	008670711
M12	30	3,05	5	008670712
M13	30	3,05	5	008670713

## 867RIBE/L

pontas para parafusos de perfil RIBE®



Ø	L mm	€	5	10
M5	75	3,40	5	008670755
M6	75	3,40	5	008670756
M7	75	3,40	5	008670757
M8	75	3,40	5	008670758
M9	75	3,40	5	008670759
M10	75	3,40	5	008670760
M11	75	4,60	5	008670761
M12	75	4,60	5	008670762
M13	75	4,60	5	008670763

## 867/...

chaves de caixa porta-pontas para artigos 867



Ø	L mm	Ø	€	5	10		
867/1	10	3/8"	38	17	6,60	5	008670600
867/2	10	1/2"	38	22	7,40	5	008670601

## 867/C20

jogo 18 bits para parafusos RIBE®, com encabadouro sextavado 10 mm e 2 acessórios



867/C20	€	5	10
	130,00	1	008670920

867RIBE	5-6-7-8-9-10-11-12-13 mm
867RIBE/L	5-6-7-8-9-10-11-12-13 mm
867/1	
867/2	
335x145x60 mm - 1,7 kg	

## 867/C38

Porta Bits com punho em T articulado, 38 sextavados 10 mm



867/C38	€	5	10
	239,00	1	008670938

852	10 mm
867PE	4-5-6-7-8-10-12mm
867PE/L	4-5-6-7-8-10-12mm
867XZN	M5-M6-M8-M10-M12
867XZN/L	M5-M6-M8-M10-M12
867TX	T20-T25-T30-T40-T45-T50-T55
867TX/L	T20-T25-T30-T40-T45-T50-T55
882	
420x185x60 mm - 3 kg	



# Beta

## 867/C52

jogo com 52 pontas,  
com porta-pontas hexagonal de 10 mm  
e 2 acessórios



867/C52 € 148,00 1 008670901

	○ 867PE	4-5-6-7-8-10-12 mm
	○ 867PE/L	4-5-6-7-8-10-12 mm
	○ 867XZN	M5-M6-M8-M10-M12
	○ 867XZN/L	M5-M6-M8-M10-M12
	⊕ 867TX	T20-T25-T30-T40-T45-T50-T55
	⊕ 867TX/L	T20-T25-T30-T40-T45-T50-T55
	⊕ 867RTX	T20-T25-T30-T40-T45-T50-T55
	⊕ 867RTX/L	T20-T25-T30-T40-T45-T50-T55
	867/1	○ 10 mm - □ 3/8"
	867/2	○ 10 mm - □ 1/2"

250x170x70 mm - 2,1 kg

## 852



852 1/4 79,117

## 882

porta-pontas com anel de retenção  
para aparafusadoras



ISO 1173 E 6,3

L mm 57 1/4 1/4 11 € 18,30 5 008820001

## 882AN

caixa de velocidades, encabadouro sextavado  
1/4"

- Para berbequins com veio 10 mm e 13 mm e chaves de impacto 1/4"
- Velocidade máx.: 3600 rpm
- Binário máx.: 30 Nm
- Porta-pontas com substituição rápida
- Relação: 1:1
- Ligação à ferramenta através de encabadouro sextavado 1/4" D6.3



ISO 1173 E 6,3  
ISO 1173 C 6,3

L mm 137 1/4 1/4 11 € 79,00 1 008820090

## 882M1

porta-pontas magnético



ISO 1173 E 6,3

L mm 50 1/4 1/4 11 € 19,30 5 008820006

## 882M

porta-pontas magnético



ISO 1173 E 6,3

L mm 75 1/4 1/4 11 € 23,30 5 008820005

## 882MSR

porta-pontas magnético com desengate rápido  
para aparafusadoras



ISO 1173 E 6,3

L mm 50 1/4 1/4 11 € 20,80 5 008820205  
75 1/4 1/4 11 € 24,30 5 008820207

## 882P

extensão para porta-bits magnético



L mm 80 1/4 1/4 10 € 17,00 5 008820080

## 892

adaptadores para aparafusadoras



892/0  
892/1  
892/2  
892/3  
892/4  
892/5  
892/6  
892/7

	□	●	L mm	€		
892/0	1/4	1/4	25	6,00	5	008920000
* 892/1	1/4	5,5	50	11,40	5	008920001
* 892/2	3/8	5,5	50	16,90	5	008920002
* 892/3	1/4	1/4	50	11,40	5	008920003
* 892/4	3/8	1/4	50	16,90	5	008920004
892/5	1/4	5/16	75	15,70	5	008920005
892/6	3/8	5/16	75	23,00	5	008920006
892/7	1/2	1/4	75	23,80	5	008920007

\* ISO 1173 A 5,5  
° ISO 1173 C 6,3

## 895

chaves de caixa porta-pontas  
refª s. 861 - 862 - 866



DIN 7427

	○	□	L mm	Ø mm	€		
895/1	1/4	1/4	25,4	12	13,70	5	008950000
895/3	1/4	3/8	29	16,8	16,30	5	008950001
895/4	5/16	3/8	29	16,8	16,30	5	008950002
895/5	1/4	1/2	38	22	16,30	5	008950005
895/6	5/16	1/2	38	22	16,30	5	008950003

## 897

porta-pontas flexível com punho



L mm 280 L1 mm 154 € 31,00 2 008970010

## 897L

porta-pontas flexível com punho,  
modelo longo



L mm 500 L1 mm 380 € 35,50 2 008970015



## NOVO DESIGN: A LINHA DE ROQUETES DA BETA, CONCEBIDOS E PRODUZIDOS NAS FÁBRICAS EM ITÁLIA, FOI REDESENHADA.

- Materiais inovadores para um desempenho superior
- A pressão manual na cabeça não provoca qualquer reversão e permite o livre retorno da alavanca
- Reversão com uma mão

Quadra fosfatada

Tamanho da cabeça reduzido

Punho ergonómico bimatéria

Orifício no punho para pendurar



Roquete com 72 dentes: ângulo de elevação de 5° para trabalhos em áreas reduzidas. Não escorrega ou des aperta sob tensão.

### 900

chaves de caixa, boca sextavadas



UNI/ISO 2725 DIN 3124

mm	Ø mm	L mm	Ø1 mm	€	10	009000032
3,2	6,6	25	11,8	4,45	10	009000040
4	6,8	25	11,8	4,45	10	009000045
4,5	7,4	25	11,8	4,45	10	009000050
5	8,0	25	11,8	4,45	10	009000055
5,5	8,7	25	11,8	4,45	10	009000060
6	9,3	25	11,8	4,45	10	009000070
7	10,4	25	11,8	4,45	10	009000080
8	11,8	25	12,7	4,45	10	009000090
9	12,7	25	11,8	4,45	10	009000100
10	14,2	25	12,0	4,45	10	009000110
11	15,8	25	12,5	4,45	10	009000120
12	17,2	25	13,5	4,45	10	009000130
13	18,0	25	13,5	4,50	10	009000140
14	20,0	25	15,0	4,60	10	009000150



900/SB13	79,50	1	009000150
4-4,5-5-5,5-6-7-8-9			
10-11-12-13-14 mm			

### 900MB

chaves de caixa boca de 12 faces



UNI/ISO 2725 DIN 3124

mm	Ø mm	L mm	Ø1 mm	€	5	009000160
4	6,7	22	11,2	8,70	5	009000161
5	7,7	25	11,2	8,70	5	009000162
5,5	8,3	25	11,2	8,70	5	009000163
6	9,0	25	11,2	8,70	5	009000164
7	10,2	25	11,2	8,70	5	009000165
8	11,3	25	12,0	8,70	5	009000166
9	13,0	25	12,0	8,70	5	009000167
10	14,3	25	12,9	8,70	5	009000168
11	16,0	25	14,3	8,70	5	009000169
12	17,4	25	16,0	8,70	5	009000170
13	18,0	25	16,4	9,60	5	009000171
14	19,3	25	17,9	10,20	5	009000171



900MB/SB12	126,00	1	009000179
4-5-5,5-6-7-8-9-10			
11-12-13-14 mm			



## 900L

chaves de caixa série longa,  
boca sextavadas



UNI/ISO 2725 DIN 3124

Ø mm	Ø mm	L mm	Ø1 mm	€	U	IC
4	6,5	50	12,0	10,50	5	009000181
4,5	7,0	50	12,0	10,50	5	009000182
5	7,5	50	12,0	10,50	5	009000183
5,5	8,5	50	12,0	10,50	5	009000184
6	9,5	50	12,0	10,50	5	009000185
7	10,5	50	12,0	10,50	5	009000186
8	12,0	50	12,0	10,50	5	009000187
9	13,0	50	13,0	10,50	5	009000188
10	14,0	50	14,0	10,90	5	009000189
11	16,0	50	16,0	10,90	5	009000190
12	17,5	50	17,5	10,90	5	009000191
13	17,5	50	17,5	10,90	5	009000192
14	20,0	50	20,0	10,90	5	009000193



900L/SB13 € 159,00 1 009000203  
4-4,5-5-5,5-6-7-8-9-10-11-12-13-14 mm

## 900MB/L

chaves de caixa série longa,  
boca de 12 faces



UNI/ISO 2725 DIN 3124

Ø mm	Ø mm	L mm	Ø1 mm	€	U	IC
5	8,0	50	12,0	16,10	3	009000211
6	9,3	50	12,0	16,10	3	009000212
7	10,9	50	12,0	16,10	3	009000213
8	11,6	50	12,0	16,10	3	009000214
9	13,0	50	12,0	16,10	3	009000215
10	14,3	50	12,8	17,10	3	009000216
11	16,0	50	14,2	17,10	3	009000217
12	17,4	50	15,5	17,10	3	009000218
13	18,0	50	16,2	17,30	3	009000219
14	19,0	50	17,1	17,60	3	009000220



## 900AS

chaves de caixa boca hexagonal



Ø mm	Ø mm	L mm	Ø1 mm	€	U	IC
5/32	8,8	25	11,9	4,90	5	009000349
3/16	7,7	25	11,9	4,90	5	009000340
7/32	8,8	25	11,9	4,90	5	009000345
1/4	9,6	25	11,9	4,90	5	009000350
9/32	10,2	25	11,9	4,90	5	009000355
5/16	11,3	25	11,9	4,90	5	009000360
11/32	12,7	25	11,6	4,90	5	009000365
3/8	14,0	25	12,9	4,90	5	009000370
7/16	15,3	25	14,5	4,90	5	009000375
1/2	17,5	25	16,4	4,95	5	009000380
9/16	19,0	25	17,9	5,10	5	009000385



900AS/SB11 € 72,50 1 009000389  
3/16-7/32-5/32-1/4-9/32-5/16  
11/32-3/8-7/16-1/2-9/16

## 900AS/MB

chaves de caixa, boca de 12 faces



SAE AS 954E

Ø mm	Ø mm	L mm	Ø1 mm	€	U	IC
3/16	7,7	22	10,9	8,90	2	009000390
7/32	8,5	22	10,9	8,90	2	009000391
1/4	9,4	22	10,9	8,90	2	009000392
9/32	10,2	22	10,9	8,90	2	009000393
5/16	11,3	22	11,7	8,90	2	009000394
11/32	12,5	22	12,0	8,90	2	009000395
3/8	13,7	22	12,9	9,50	2	009000396
7/16	15,6	22	14,3	9,50	2	009000397
1/2	17,2	22	16,4	10,50	2	009000398
9/16	18,8	24	17,9	10,60	2	009000399

## 900AS/L

chaves de caixa série longa,  
boca hexagonal



SAE AS 954E

Ø mm	Ø mm	L mm	Ø1 mm	€	U	IC
3/16	7,0	50	12,0	10,90	2	009000301
7/32	8,5	50	12,0	10,90	2	009000303
1/4	9,8	50	12,0	10,90	2	009000305
9/32	10,5	50	12,0	10,90	2	009000307
5/16	12,0	50	12,0	10,90	2	009000309
11/32	13,0	50	13,0	10,90	2	009000311

Ø mm	L mm	Ø1 mm	€	U	IC	
3/8	14,0	50	14,0	10,90	2	009000313
7/16	16,0	50	16,0	10,90	2	009000315
1/2	17,5	50	17,5	10,90	2	009000317
9/16	20,0	50	20,0	11,70	2	009000319

## 900AS/MBL

chaves de caixa série longa,  
boca de 12 faces



Ø mm	Ø mm	L mm	Ø1 mm	€	U	IC
5/32	6,8	50	12,0	16,90	2	009000325
3/16	8,0	50	12,0	16,90	2	009000326
7/32	8,5	50	12,0	16,90	2	009000327
1/4	9,8	50	12,0	16,90	2	009000328
9/32	10,9	50	12,0	16,90	2	009000329
5/16	11,6	50	12,0	16,90	2	009000330
11/32	13,0	50	12,0	16,90	2	009000331
3/8	14,3	50	12,8	18,10	2	009000332
7/16	16,0	50	14,2	18,10	2	009000333
1/2	18,0	50	16,2	18,10	2	009000334
9/16	19,0	50	17,1	18,10	2	009000335

## 900U

chaves de caixa para bloqueio/desbloqueio de  
caixa de velocidades



Ø mm	"	Ø	Ø	€	U	IC
4	5/32	E5	M5	4,70	5	009001702
4,5	3/16	E6		4,70	5	009001703
5	13/64		M6	4,70	5	009001704
5,5	7/32	E7		4,70	5	009001705
6	1/4	E8	M8	4,70	5	009001706
7	9/32			4,70	5	009001707
8	5/16	E10	M10	4,70	5	009001708
9	11/32			4,70	5	009001709
10	3/8	E12	M12	4,70	5	009001710
11	7/16	E14	M14	4,70	5	009001711
12	15/32	E16		4,70	5	009001712
13	1/2		M16	4,75	5	009001713
14	9/16	E18	M18	4,80	5	009001714



900U/SB13 € 82,00 1 009001750  
4-4,5-5-5,5-6-7-8-9  
10-11-12-13-14 mm

## 900FTX

chaves de caixa para parafusos com cabeça Torx®

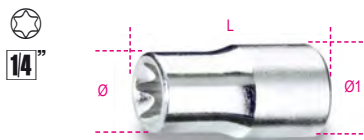

Ø	L	Ø1	€	5	10
mm	mm	mm			
E4	5,4	22	11,2	8,30	5 009000404
E5	6,7	22	11,2	8,30	5 009000405
E6	7,7	22	11,2	8,30	5 009000406
E7	8,3	22	11,2	8,30	5 009000407
E8	9,6	22	11,2	8,30	5 009000408
E10	11,3	22	12,0	8,30	5 009000410
E11	12,1	22	12,5	11,40	5 009000411
E12	12,9	23	12,9	11,40	5 009000412
E14	14,0	25	14,0	11,40	5 009000414



**900FTX/SB9** € 99,50 1 009000419  
E4-E5-E6-E7-E8  
E10-E11-E12-E14

## 900LP

chaves de caixa com ponta de perfil de fenda

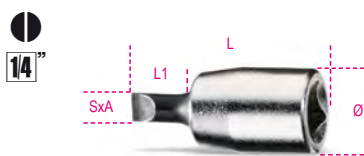

SxA	Ø	L	L1	€	5	10
mm	mm	mm	mm			
0,8x4	12	28	9	10,10	5 009000605	
1x5,5	12	28	9	10,10	5 009000610	
1,2x6,5	12	28	9	10,10	5 009000615	
1,2x8	13	28	8	10,10	5 009000620	
1,6x10	14	28	8	10,10	5 009000625	

## 900MC/LP

chaves de caixa com ponta de perfil de fenda, coloridas

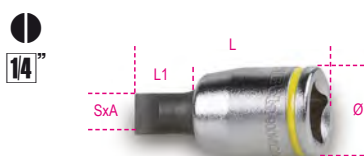

SxA	Ø	L	L1	€	5	10
mm	mm	mm	mm			
0,8x4	12	28	9	15,70	3 009002605	
1,2x6,5	12	28	9	15,70	3 009002615	
1,2x8	13	28	8	15,70	3 009002620	

## 900PH

chaves de caixa com ponta de perfil Phillips(R)



PH	Ø	L	L1	€	5	10
	mm	mm	mm			
1	12	28	12	10,90	5 009000701	
2	12	28	12	10,90	5 009000702	
3	12	28	12	10,90	5 009000703	
4	13	28	11	10,90	5 009000704	



**900PH/SB4** € 53,00 1 009000708  
PH1-PH2-PH3-PH4

## 900MC/PH

chave de caixa com ponta para parafusos Phillips®, coloridas

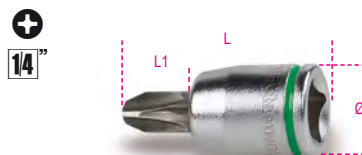

PH	Ø	L	L1	€	5	10
	mm	mm	mm			
1	12	28	12	16,40	3 009002701	
2	12	28	12	16,40	3 009002702	
3	12	28	12	16,40	3 009002703	

## 900PZ

chaves de caixa com ponta para parafusos Pozidriv®-Supadriv®



PZ	Ø	L	€	5	10
	mm	mm			
1	12	28	11,50	3 009000711	
2	12	28	11,50	3 009000712	
3	12	28	11,50	3 009000713	

## 900ME

chaves de caixa com ponta macho sextavadas



mm	Ø	L	L1	€	5	10
	mm	mm	mm			
2,5	12	25	4,5	9,50	5 009000502	
3	12	25	5,0	9,50	5 009000503	
4	12	25	5,6	9,50	5 009000504	
5	12	25	6,3	9,50	5 009000505	
6	12	25	7,6	9,50	5 009000506	
7	13	25	7,2	9,50	5 009000507	
8	13	25	8,0	9,50	5 009000508	
10	13	25	8,7	11,70	5 009000510	



**900ME/SB8** € 92,50 1 009000518  
2,5-3-4-5-6-7-8-10 mm

## 900PE/AS

chaves de caixa com ponta macho sextavada



"	Ø	L	€	5	10
	mm	mm			
1/8	11,9	25	21,50	5 009000521	
5/32	11,9	25	21,50	5 009000522	
3/16	11,9	25	21,50	5 009000523	
7/32	11,9	25	21,50	5 009000524	
1/4	11,9	25	21,50	5 009000525	
9/32	13,1	25	21,50	5 009000526	
5/16	13,1	25	21,50	5 009000527	

## 900PT

chaves de caixa com pontas de 5 nervuras e furo central



PT	Ø	L	L1	€	5	10
	mm	mm	mm			
PT10	12	28	12	20,10	5 009000750	
PT15	12	28	12	20,10	5 009000755	
PT20	12	28	12	20,10	5 009000760	
PT25	12	28	12	20,10	5 009000765	
PT27	12	28	12	20,10	5 009000767	
PT30	12	28	12	20,10	5 009000770	

## 900TX

chaves de caixa com ponta macho de perfil Torx®



Ø	L	L1	€	5	10
mm	mm	mm			
T6	12	28	14,70	5	009000717
T7	12	28	14,70	5	009000718
T8	12	28	14,80	5	009000719
T9	12	28	14,80	5	009000720
T10	12	28	14,80	5	009000721
T15	12	28	14,80	5	009000722
T20	12	28	14,80	5	009000723
T25	12	28	14,80	5	009000724
T27	12	28	14,80	5	009000725
T30	12	28	14,80	5	009000726
T40	12	28	14,80	5	009000727



900TX/SB8	€	1	10
T9-T10-T15-T20 T25-T27-T30-T40	132,00	1	009000730

## 900MC/TX

chaves de caixa com ponta de perfil Torx®, coloridas



Ø	L	L1	€	3	10
mm	mm	mm			
T10	12	28	16,90	3	009002721
T15	12	28	16,90	3	009002722
T20	12	28	16,90	3	009002723
T25	12	28	16,90	3	009002724
T27	12	28	16,90	3	009002725
T30	12	28	16,90	3	009002726
T40	12	28	16,90	3	009002727

## 900/16

adaptador quadra fêmea de 1/4" para quadra macho de 3/8"



UNI/ISO 3316 DIN 3123

L	Ø	€	5	10
mm	mm			
28	13,0	7,70	5	009000814

## 900/...

extensões com quadras macho e fêmea de 1/4"

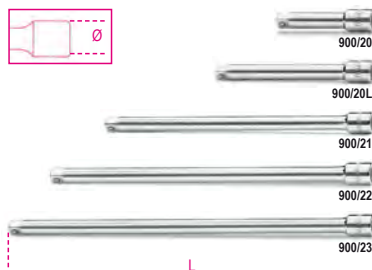
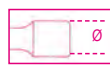

UNI/ISO 3316 DIN 3123

L	Ø	€	5	10
mm	mm			
900/20	50	9,80	5	009000818
900/20L	100	10,10	5	009000819
900/21	150	10,50	5	009000822
900/22	250	15,40	5	009000823
900/23	350	18,50	5	009000824

## 900AN

extensões com quadras macho angulares e fêmea de 1/4"

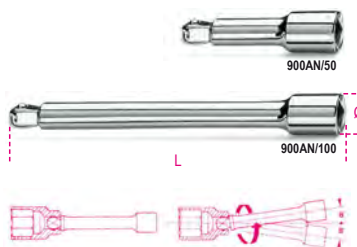

L	Ø	€	3	10
mm	mm			
900AN/50	50	10,60	3	009000825
900AN/100	100	11,70	3	009000826

## 900FL

extensão flexível com quadras macho e fêmea de 1/4"

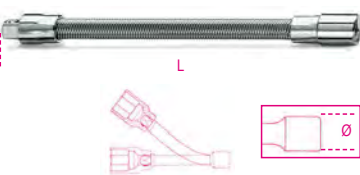

L	Ø	€	3	10
mm	mm			
150	12	15,60	3	009000828

## 900/25

cardan com quadras macho e fêmea de 1/4"



UNI/ISO 3316 DIN 3123

L	Ø	€	5	10
mm	mm			
41	12,5	19,00	5	009000830

## 900BG/30C

extensão 1/4" com punho, série curta



UNI/ISO 3315 DIN 3122

L	L1	€	5	10
mm	mm			
128	20	9,40	5	009000833

## 900BG/30

extensão 1/4" com punho



UNI/ISO 3315 DIN 3122

L	L1	€	5	10
mm	mm			
176	68	9,80	5	009000834

## 900/32

extensão flexível com punho quadra macho de 1/4"



L	L1	€	2	10
mm	mm			
280	154	22,50	2	009000839

## 900/35A

cabo articulado com punho quadra de 1/4"



UNI/ISO 3315 DIN 3122

L	L1	€	5	10
mm	mm			
148	84	32,00	5	009000840

## 900M/35

cabo articulado com punho metálico quadra de 1/4"



UNI/ISO 3315  
DIN 3122

L	€	3	10
mm			
130	41,00	3	009000845



## 900/40

punho com cardan macho de 1/4"

1/4"



L	L1	€	3	009000843
mm	mm			
390	145	43,00		

## 900/42

cabo T corredeço, quadra de 1/4"

1/4"



UNI/ISO 3315 DIN 3122

L	A	€	5	009000854
mm	mm			
115	22	10,70		

## 900T/44

chave macho quadrada 1/4" com punho

1/4"



L	L1	€	2	009000860
mm	mm			
238	105	16,20		

## 900/55

roquete reversível quadra macho 1/4", mecanismo 48 dentes

48

1/4"



UNI/ISO 3315 DIN 3122

L	Ø	A	€	5	009001155
mm	mm	mm			
127	25	29	52,50		

## 900/55Z

Roquete reversível com quadra de 1/4", 72 dentes

72

1/4"



L	Ø	A	€	3	009000882
mm	mm	mm			
126	25	23	51,50		

## 900M/55

roquete reversível com punho metálico quadra de 1/4"

1/4"



UNI/ISO 3315  
DIN 3122

L	Ø	A	€	3	009000905
mm	mm	mm			
110	22	18	66,00		

Mecanismos rotativos de substituição para roquetes

111

## 900/58

roquete reversível quadra de 1/4" com punho rotativo, 52 dentes

- Funcionamento através de punho rotativo
- Botão de desbloqueio da chave de caixa
- Sistema de inversão através de porca na cabeça do roquete
- Punho bi-material

1/4"

52



L	Ø	A	€	2	009000884
mm	mm	mm			
126	28	28,5	78,00		

## 900/C39N

11 chaves de caixa sextavadas, 21 bits e 7 acessórios

1/4"

1/4"



900/C39N	€	1	009000947
	231,00		

861LP	0,6x4,5 - 1,2x6,5 - 1,2x8 mm
861PH	PH1-PH2-PH3
861PZ	PZ1-PZ2-PZ3
861PE	2,5-3-4-5-6 mm
861RTX	T10-T15-T20-T25-T27-T30-T40
900	5-5,5-6-7-8-9-10-11-12-13-14 mm
900/20	50 mm
900/20L	100 mm
900/25	
900BG/30C	128 mm
892/0	
895/1	
900/55Z	126 mm

## 900/C39U

11 chaves de caixa, 21 bits e 7 acessórios

1/4"

1/4"



900/C39U	€	1	009001947
	233,00		

861LP	0,6x4,5 - 1,2x6,5 - 1,2x8 mm
861PH	PH1-PH2-PH3
861PZ	PZ1-PZ2-PZ3
861PE	2,5-3-4-5-6 mm
861RTX	T10-T15-T20-T25-T27-T30-T40
900U	5-5,5-6-7-8-9-10-11-12-13-14 mm * 13/64-7/32-1/4-9/32-5/16 11/32-3/8-7/16-15/32-1/2-9/16 E7-E8-E10-E12-E14-E16-E18 M6-M8-M10-M12-M14-M16-M18
900/20	50 mm
900/20L	100 mm
900/25	
900BG/30C	128 mm
892/0	
895/1	
900/55Z	126 mm



## 900/C11

jogo com 11 chaves de caixa sextavadas, 20 pontas e 8 acessórios

1/4"  
1/4"



900/C11 € 252,00 1 009000971

	861LP	0,5x3 - 0,8x5,5 1x5,5 - 1,2x6,5 mm
	861PE	3 - 4 - 5 - 6 - 8 mm
	861PH	0 - 1 - 2 - 3
	861TX	T8 - T10 - T15 - T20 T25 - T30 - T40
	895/1	
	900	5 - 5,5 - 6 - 7 - 8 - 9 - 10 11 - 12 - 13 - 14 mm
	900/16	□ 1/4 - ■ 3/8
	900/20	50 mm
	900/21	150 mm
	900/25	
	900BG/30	176 mm
	900/42	
	900/55	

≡ 270x120x45 mm - 1,2 kg

9899 900C11 € 15,20 1 098990132  
Tabuleiro maleável, vazio

## 900/C11Z

conjunto de 11 chaves sextavadas, 20 bits e 8 acessórios

1/4"  
1/4"



900/C11Z € 251,00 1 009000984

	861LP	0,5x3 - 0,8x5,5 - 1x5,5 - 1,2x6,5 mm
	861PE	3 - 4 - 5 - 6 - 8 mm
	861PH	0 - 1 - 2 - 3
	861TX	T8 - T10 - T15 - T20 T25 - T30 - T40
	895/1	
	900	5 - 5,5 - 6 - 7 - 8 - 9 - 10 11 - 12 - 13 - 14 mm
	900/16	□ 1/4 - ■ 3/8
	900/20	50 mm
	900/21	150 mm
	900/25	
	900BG/30	176 mm
	900/42	
	900/55Z	

≡ 350x150x50 mm - 1,2 kg

9899 900C11 € 15,20 1 098990132  
Tabuleiro maleável, vazio

## 900/C12MR

Jogo de 12 chaves de caixa sextavadas, 20 pontas e 7 acessórios em módulo soft e caixa metálica

1/4"  
1/4"



900/C12MR € 281,00 1 009000962

	900	4-5-5,5-6-7-8-9-10-11-12-13-14 mm
	900/20	50 mm
	900/21	150 mm
	900/25	
	900/42	115 mm
	900BG/30	128 mm
	900/58	
	895/1	
	861TX	T8-T10-T15-T20-T25-T30-T40
	861PH	PH0-PH1-PH2-PH3
	861LP	0,5-0,8-1-1,2 mm
	861PE	3-4-5-6-8 mm

≡ 350x150x50 mm 1,3 kg

## 900/C12MZ

Jogo de 12 chaves de caixa sextavadas, 20 bits e 7 acessórios, em estojo metálico com módulo soft

1/4"  
1/4"



900/C12MZ € 254,00 1 009000983

	900	4-5-5,5-6-7-8-9-10-11-12-13-14 mm
	900/20	50 mm
	900/21	150 mm
	900/25	
	900/42	115 mm
	900BG/30	176 mm
	900/55Z	
	895/1	
	861TX	T8-T10-T15-T20-T25-T30-T40
	861PH	PH0-PH1-PH2-PH3
	861LP	0,5x3 - 0,8x5,5 - 1x5,5 - 1,2x6,5 mm
	861PE	3-4-5-6-8 mm

≡ 350x150x50 mm - 1,2 kg

## 900/C13-5

jogo com 13 chaves hexagonais e 5 acessórios

1/4"



900/C13-5 € 205,00 1 009000953

	900	4 - 4,5 - 5 - 5,5 - 6 - 7 - 8 - 9 10 - 11 - 12 - 13 - 14 mm
	900/21	150 mm
	900/25	
	900BG/30	
	900/42	
	900/55	

≡ 270x120x45 mm - 1 kg

9899 900/C13-5 € 15,20 1 098990131  
Tabuleiro maleável, vazio

## 900/C13-8

jogo com 13 chaves hexagonais e 8 acessórios

1/4"



900/C13-8 € 248,00 1 009000954

	900	4 - 4,5 - 5 - 5,5 - 6 - 7 - 8 - 9 10 - 11 - 12 - 13 - 14 mm
	900/16	□ 1/4 - ■ 3/8
	900/20	50 mm
	900/21	150 mm
	900/25	
	900BG/30	
	900/35A	
	900/42	
	900/55	

≡ 270x120x45 mm - 1,1 kg



## 900MB/C19

jogo com 11 chaves de caixa de 12 faces e 8 acessórios

1/4"



900MB/C19 € 287,00 1 009000977

	900MB	5 - 5,5 - 6 - 7 - 8 - 9 - 10 - 11 12 - 13 - 14 mm
	900/16	□ 1/4 - ■ 3/8
	900/20	50 mm
	900/21	150 mm
	900/25	
	900BG/30	
	900/35A	
	900/42	
	900/55	
≡ 270x120x45 mm - 1,1 kg		

## 900MB/C28

jogo com 11 chaves de caixa de 12 faces, 11 pontas e 6 acessórios

1/4"



900MB/C28 € 358,00 1 009000979

	900MB	5 - 5,5 - 6 - 7 - 8 - 9 - 10 - 11 12 - 13 - 14 mm
	900LP	0,8x4 - 1,2x6,5 - 1,2x8 mm
	900PH	PH1 - PH2 - PH3
	900ME	3 - 4 - 5 - 6 - 8 mm
	900/20	50 mm
	900/21	150 mm
	900/25	
	900BG/30	
	900/42	
	900/55	
≡ 270x120x45 mm - 1,1 kg		

## 900MC/C32

11 chaves de caixa sextavadas, 20 pontas coloridas e 7 acessórios

1/4"



900MC/C32 € 264,00 1 009002963

	900MC	4 - 5 - 6 - 7 - 8 - 9 - 10 - 11 - 12 - 13 - 14 mm
	860LP	0,5x3 - 0,8x5,5 - 1,0x5,5 - 1,2x6,5 mm
	860PH	0 - 1 - 2 - 3
	860PE	3 - 4 - 5 - 6 - 8 mm
	860TX	T8 - T10 - T15 - T20 - T25 - T30 - T40
	895/1	
	900/20	
	900/21	
	900/25	
	900BG/30	
	900/42	
	900/55	
≡ 270x120x45 mm - 1,2 kg		

## 900/C24

jogo com 13 chaves de caixa hexagonais, 11 pontas e 6 acessórios

1/4"



900/C24 € 318,00 1 009000956

	900	4 - 4,5 - 5 - 5,5 - 6 - 7 - 8 - 9 10 - 11 - 12 - 13 - 14 mm
	900LP	0,8x4 - 1,2x6,5 - 1,2x8 mm
	900PH	PH1 - PH2 - PH3
	900ME	3 - 4 - 5 - 6 - 8 mm
	900/20	50 mm
	900/21	150 mm
	900/25	
	900BG/30	
	900/42	
	900/55	
≡ 270x120x45 mm - 1,1 kg		

## 900MC/C24

11 chaves de caixa sextavadas, 13 pontas coloridas e 6 acessórios

1/4"



900MC/C24 € 418,00 1 009002960

	900MC	4 - 5 - 6 - 7 - 8 - 9 10 - 11 - 12 - 13 - 14 mm
	900MC/PH	PH1 - PH2 - PH3
	900MC/TX	T10 - T15 - T20 - T25 - T27 - T30 - T40
	900MC/LP	0,8x4 - 1,2x6,5 - 1,2x8 mm
	900/20	50 mm
	900/21	150 mm
	900/25	
	900BG/30	
	900/42	
	900/55	
≡ 270x120x45 mm - 1,1 kg		

## 900U/C12M

jogo 12 chaves de caixa para bloqueio/ desbloqueio de caixa de velocidades, 20 bits e 7 acessórios, em módulo soft

1/4"



900U/C12M € 258,00 1 009001792

	900U	○ 4-5-5,5-6-7-8-9-10-11-12-13-14 mm * 5/32-3/16-13/64-7/32-1/4-9/32-5/16 11/32-3/8-7/16-15/32-1/2-9/16 ◎ E5-E6-E7-E8-E10-E12-E14-E16-E18 ○ M5-M6-M8-M10-M12-M14-M16-M18 50 mm
	900/20	50 mm
	900/21	150 mm
	900/25	
	900/42	115 mm
	900BG/30	176 mm
	900/55	
	895/1	○ 1/4 - □ 1/4
	861LP	0,5x3 - 0,8x5,5 - 1,0x5,5 - 1,2x6,5 mm
	861PE	3-4-5-6-8 mm
	861PH	PH0-PH1-PH2-PH3
	861TX	T8-T10-T15-T20-T25-T30-T40
≡ 350x150x50 mm - 1,2 kg		



## 900AS/C10 - /MB-C17

jogo com 10 chaves de caixa e 7 acessórios

14"



900AS/C10 € 232,00 1 009000961

	900AS	3/16 - 7/32 - 1/4 - 9/32 - 5/16 11/32 - 3/8 - 7/16 - 1/2 - 9/16
	900/20	50 mm
	900/21	150 mm
	900/25	
	900BG/30	
	900/35A	
	900/42	
	900/55	

270x120x45 mm - 1,1 kg

900AS/MB-C17 € 275,00 1 009000981

	900AS/MB	3/16 - 7/32 - 1/4 - 9/32 - 5/16 11/32 - 3/8 - 7/16 - 1/2 - 9/16
	900/20	50 mm
	900/21	150 mm
	900/25	
	900BG/30	
	900/35A	
	900/42	
	900/55	

270x120x45 mm - 1,1 kg

## 900AS/C17-MBM

jogo com 10 chaves de caixa com 12 faces e 7 acessórios

14"



900AS/C17-MBM € 297,00 1 009000982

	900AS/MB	3/16 - 7/32 - 1/4 - 9/32 - 5/16 11/32 - 3/8 - 7/16 - 1/2 - 9/16
	900/20	50 mm
	900/21	150 mm
	900/25	
	900BG/30	
	900M/35	
	900/42	
	900M/55	

270x120x45 mm - 1,2 kg

## 900/C11HR

11 chaves de caixa sextavadas, 20 bits e 7 acessórios, em estojo metálico com tabuleiro rígido

• roquete com punho rotativo

14"

14"



900/C11HR € 278,00 1 009000980

	861LP	0,5x3-0,8x5,5-1x5,5-1,2x6,5 mm
	861PH	PH0-PH1-PH2-PH3
	861PE	3-4-5-6-8 mm
	861TX	T8-T10-T15-T20-T25-T30-T40
	895/1	
	900	5-5,5-6-7-8-9-10-11-12-13-14 mm
	900/16	□ 1/4 - ■ 3/8
	900/20	50 mm
	900/21	150 mm
	900/25	
	900/42	
	900BG/30	
	900/58	

350x150x50 mm - 1,3 kg

## 902R/C6

jogo de 6 conversores de quadra para chaves de caixa



902R/C6 € 123,00 1 009020814

	900/16	□ 1/4 - ■ 3/8
	910/15	□ 3/8 - ■ 1/4
	910/16	□ 3/8 - ■ 1/2
	920/15	□ 1/2 - ■ 3/8
	920/16	□ 1/2 - ■ 3/4
	928/15	□ 3/4 - ■ 1/2

170x100x35 mm - 600 g

## 902A/C22

Jogo de 22 chaves de caixa hexagonal e 6 acessórios em caixa metálica

14"

12"



902A/C22 € 405,00 1 009020807

	900	5-5,5-6-7-8-9-10-11-12-13 mm
	900/20	50 mm
	900/25	
	900/55	
	920A	10-13-14-15-17-18-19 22-24-27-30-32 mm
	920/21	125 mm
	920/25	
	920/55	

420x185x60 mm - 3,5 kg

9899 902A/C22 € 15,20 1 098990133

Tabuleiro maleável, vazio

## 910A

chaves de caixa, boca sextavadas



UNI/ISO 2725 DIN 3124

mm	Ø	L	Ø1	€		
6	9,5	28	16,7	7,20	5	009100006
7	10,7	28	16,7	7,20	5	009100007
8	12,1	28	16,7	7,20	5	009100008
9	13,2	28	16,7	7,20	5	009100009
10	14,6	29	16,7	7,20	5	009100010
11	15,8	29	16,7	7,20	5	009100011
12	17,2	30	17,7	7,50	5	009100012
13	18,4	31	17,0	7,50	5	009100013
14	19,7	32	17,5	7,50	5	009100014
15	20,9	32	18,0	7,50	5	009100015
16	22,2	33	18,5	8,40	5	009100016
17	23,2	33	19,0	8,40	5	009100017
18	24,7	34	20,0	8,40	5	009100018
19	25,8	35	21,0	8,40	5	009100019
20	27,2	35	22,0	9,00	5	009100020
21	28,2	36	23,0	9,00	5	009100021
22	29,7	37	24,0	9,10	5	009100022



910A/SB17 € 160,00 1 009100030

6-7-8-9-10-11-12  
13-14-15-16-17  
18-19-20-21-22 mm

## 910B

chaves de caixa, boca de 12 faces



UNI/ISO 2725 DIN 3124

mm	Ø mm	L mm	Ø1 mm	€	🔧	📦
6	9,5	28	16,7	7,20	5	009100106
7	10,7	28	16,7	7,20	5	009100107
8	12,1	28	16,7	7,20	5	009100108
9	13,2	28	16,7	7,20	5	009100109
10	14,6	29	16,7	7,20	5	009100110
11	15,8	29	16,7	7,20	5	009100111
12	17,2	30	17,7	7,50	5	009100112
13	18,4	31	17,0	7,50	5	009100113
14	19,7	32	17,5	7,50	5	009100114
15	20,9	32	18,0	7,50	5	009100115
16	22,2	33	18,5	8,40	5	009100116
17	23,2	33	19,0	8,40	5	009100117
18	24,7	34	20,0	8,40	5	009100118
19	25,8	35	21,0	8,40	5	009100119
20	27,2	35	22,0	9,00	5	009100120
21	28,2	36	23,0	9,00	5	009100121
22	29,7	37	24,0	9,10	5	009100122



910B/SB17	160,00	🔧	📦
6-7-8-9-10-11-12			1 009100130
13-14-15-16-17			
18-19-20-21-22 mm			

## 910AL

chaves de caixa série longa, boca hexagonal



UNI/ISO 2725 DIN 3124

mm	Ø mm	L mm	Ø1 mm	€	🔧	📦
8	12,0	55	17	15,00	3	009100158
9	13,0	55	17	15,00	3	009100159
10	14,5	55	17	15,00	3	009100160
11	16,0	55	17	15,00	3	009100161
12	17,0	55	17	15,00	3	009100162
13	18,0	55	17	16,40	3	009100163
14	20,0	55	18	16,40	3	009100164
15	21,0	55	20	16,40	3	009100165
16	22,0	55	20	16,40	3	009100166
17	23,5	55	22	16,40	3	009100167
18	24,5	55	23	17,90	2	009100168
19	25,0	55	24	17,90	2	009100169
21	27,0	65	26	19,20	2	009100171
22	29,0	65	28	19,20	2	009100172



910AL/SB14	253,00	🔧	📦
8-9-10-11-12-13-14			1 009100174
15-16-17-18-19-21-22 mm			

## 910BL

chaves de caixa série longa, boca de 12 faces



UNI/ISO 2725 DIN 3124

mm	Ø mm	L mm	Ø1 mm	€	🔧	📦
8	12,0	55	17	15,00	3	009100308
9	13,0	55	17	15,00	3	009100309
10	14,5	55	17	15,00	3	009100310
11	16,0	55	17	15,00	3	009100311
12	17,0	55	17	15,00	3	009100312
13	18,0	55	17	16,40	3	009100313
14	20,0	55	18	16,40	3	009100314
15	21,0	55	20	16,40	3	009100315
16	22,0	55	20	16,40	3	009100316
17	23,5	55	22	16,40	3	009100317
18	24,5	55	23	17,90	2	009100318
19	25,0	55	24	17,90	2	009100319
21	27,0	65	26	19,20	2	009100321
22	29,0	65	28	19,20	2	009100322



910BL/SB14	253,00	🔧	📦
8-9-10-11-12-13			1 009100340
14-15-16-17-18			
19-21-22 mm			

## 910B/SN

chaves de caixa articuladas com boca de 12 faces



mm	Ø mm	L mm	Ø1 mm	€	🔧	📦
10	14,5	48,5	19	38,50	2	009100230
11	15,8	49,5	19	38,50	2	009100231
12	17,0	50,0	19	38,50	2	009100232
13	18,3	51,0	19	38,50	2	009100233
14	19,5	51,0	19	43,00	2	009100234
15	20,8	53,5	19	43,00	2	009100235
16	22,0	53,5	19	43,00	2	009100236
17	23,3	54,5	19	43,00	2	009100237
18	24,5	54,5	19	43,00	2	009100238
19	25,8	56,5	19	43,00	2	009100239

## 910A/AS

chaves de caixa, boca hexagonal



"	Ø mm	L mm	Ø1 mm	€	🔧	📦
1/4	10,3	26	17,3	8,50	5	009100276
5/16	11,9	26	17,3	8,50	5	009100278
11/32	13,3	26	17,3	8,50	5	009100279
3/8	13,9	26	17,3	8,50	5	009100280
7/16	15,8	26	17,3	8,50	5	009100281
1/2	17,9	26	17,3	8,70	5	009100283
9/16	19,5	27	18,5	8,70	5	009100284
19/32	20,6	27	19,5	8,70	5	009100285
5/8	21,9	28	20,0	9,40	5	009100286
11/16	24,6	30	22,5	9,40	5	009100287
3/4	25,9	30	23,5	9,40	5	009100289
13/16	27,9	32	26,0	10,50	5	009100291
7/8	29,6	32	26,5	10,80	5	009100292



910A-AS/SB13	139,00	🔧	📦
1/4-5/16-11/32-3/8-7/16			1 009100295
1/2-9/16-19/32-5/8-11/16			
3/4-13/16-7/8			

## 910AS

chaves de caixa, boca de 12 faces



"	Ø mm	L mm	Ø1 mm	€	🔧	📦
1/4	9,5	28	16,7	8,50	5	009100201
5/16	12,1	28	16,7	8,50	5	009100202
11/32	13,2	28	16,7	8,50	5	009100203
3/8	14,6	29	16,7	8,50	5	009100204
7/16	15,8	29	16,7	8,50	5	009100205
1/2	18,4	31	17,0	8,70	5	009100206
9/16	19,7	32	17,5	8,70	5	009100207
19/32	20,9	32	18,0	8,70	5	009100208
5/8	22,2	33	18,5	9,40	5	009100209
11/16	24,7	34	20,0	9,40	5	009100210
3/4	25,8	35	21,0	9,40	5	009100211
13/16	28,2	36	23,0	10,50	5	009100212
7/8	29,7	37	24,0	10,80	5	009100213



910AS/SB13	139,00	🔧	📦
1/4-5/16-11/32-3/8-7/16			1 009100215
1/2-9/16-19/32-5/8-11/16			
3/4-13/16-7/8			

## 910AS/L

chaves de caixa série longa,  
boca de 12 faces

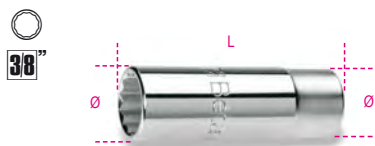

Ø	L	Ø1	€	Unidade	Art. Beta
mm	mm	mm			
1/4	10	55	18,90	3	009100350
5/16	12	55	18,90	3	009100351
3/8	14	55	18,90	3	009100352
7/16	16	55	18,90	3	009100353
1/2	18	55	21,00	3	009100354
9/16	20	55	21,00	3	009100355
19/32	21	55	21,50	3	009100356
5/8	22	55	21,50	3	009100357
11/16	23	55	21,50	3	009100359
3/4	25	55	22,90	3	009100360
13/16	27	65	26,50	3	009100362
7/8	29	65	26,50	3	009100363



**910ASL/SB12** 278,00 1 009100365  
1/4-5/16-3/8-7/16  
1/2-9/16-19/32-5/8-11/16  
3/4-13/16-7/8

## 910AS/SN

chaves de caixa articuladas  
com boca de 12 faces



\* SAE AS 954E

Ø	L	Ø1	€	Unidade	Art. Beta
mm	mm	mm			
* 3/8	14,0	48,0	42,50	2	009100260
* 7/16	15,8	51,0	42,50	2	009100261
* 1/2	18,3	51,0	42,50	2	009100262
* 9/16	19,5	51,0	43,00	2	009100263
* 5/8	22,0	53,5	43,00	2	009100264
11/16	24,5	54,5	46,00	2	009100265
3/4	25,8	56,5	46,00	2	009100266

## 910FTX

chaves de caixa para parafusos  
de perfil Torx®



Ø	L	Ø1	€	Unidade	Art. Beta
mm	mm	mm			
E4	6,2	26	10,10	5	009100404
E5	7,0	26	10,10	5	009100405
E6	8,3	26	10,10	5	009100406
E7	8,9	26	10,10	5	009100407
E8	9,9	26	10,10	5	009100408
E10	12,0	26	10,10	5	009100410
E11	13,3	26	10,10	5	009100411

Ø	L	Ø1	€	Unidade	Art. Beta
mm	mm	mm			
E12	14,5	26	10,10	5	009100412
E14	15,8	26	10,10	5	009100414
E16	18,0	26	10,10	5	009100416
E18	19,5	26	11,10	3	009100418
E20	21,9	26	11,10	3	009100420



**910FTX/SB9** 106,00 1 009100430  
E4-E5-E6-E7-E8  
E10-E12-14-E16

## 910FTX/L

chaves de caixa série longa  
para parafusos de perfil Torx®



Ø	L	Ø1	€	Unidade	Art. Beta
mm	mm	mm			
E4	6,2	55	22,60	3	009100440
E5	7,0	55	22,60	3	009100441
E6	8,3	55	22,60	3	009100442
E7	8,9	55	22,60	3	009100443
E8	9,9	55	22,60	3	009100444
E10	12,0	55	22,60	3	009100445



**910FTX-L/SB6** 148,00 1 009100449  
E4-E5-E6  
E7-E8-E10

## 910FTX/XL

chaves de caixa para parafusos de perfil  
Torx®, série extra-longa



Ø	L	Ø1	€	Unidade	Art. Beta
mm	mm	mm			
E6	8,0	200	20,30	2	009100766
E7	8,0	200	20,30	2	009100767
E8	10,0	200	20,30	2	009100768
E10	14,0	200	20,30	2	009100770
E11	14,0	200	20,30	2	009100771
E12	14,0	200	20,30	2	009100772
E14	17,0	200	22,20	2	009100774
E16	18,6	200	22,20	2	009100776
E18	21,5	200	23,50	2	009100778
E20	21,5	200	23,50	2	009100780

## 910FTX-XL/C10

Conjunto de 10 chaves de caixa para  
parafusos com perfil Torx®, série longa, em  
caixa de plástico



**910FTX/XL-C10** 213,00 1 009100976  
E6-E7-E8-E10-E11-  
E12-E14-E16-E18-E20

255x195x62 mm - 2,3 kg

## 910LP

chaves de caixa com ponta  
de perfil de fenda



SxA	Ø	L	L1	€	Unidade	Art. Beta
mm	mm	mm	mm			
1x5,5	18,5	54	24	17,70	2	009100452
1,2x6,5	18,5	54	24	17,70	2	009100453
1,2x8	18,5	54	24	17,70	2	009100454
1,6x9	18,5	54	24	17,70	2	009100456

## 910PH

chaves de caixa com ponta  
de perfil Phillips®

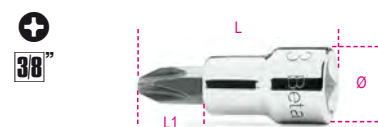

PH	Ø	L	L1	€	Unidade	Art. Beta
	mm	mm	mm			
1	18,5	48	18	16,50	2	009100471
2	18,5	48	18	16,50	2	009100472
3	18,5	48	18	16,50	2	009100473
4	18,5	48	18	16,50	2	009100474



**910PH/SB4** 75,50 1 009100478  
PH1-PH2-PH3-PH4





## 910PE

chaves de caixa com ponta macho hexagonal

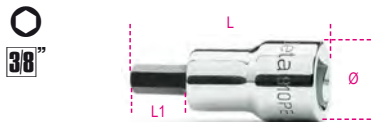

DIN 7422

mm	Ø mm	L mm	L1 mm	€	🔧	📦
3	18,5	50	20	14,40	5	009100490
4	18,5	50	20	14,40	5	009100492
5	18,5	50	20	14,40	5	009100494
6	18,5	50	20	14,40	5	009100496
7	18,5	50	20	14,40	5	009100497
8	18,5	50	20	14,40	5	009100498
9	18,5	50	20	14,40	5	009100499
10	18,5	50	20	14,40	5	009100500



910PE/SB7 114,00 1 009100503  
3-4-5-6-7-8-10 mm

## 910BP

Chaves de caixa com ponta macho sextavada



mm	L mm	H mm	€	🔧	📦
4L	92	62	17,20	3	009100584
5L	92	62	17,20	3	009100585
6L	92	62	17,20	3	009100586
7L	92	62	17,20	3	009100587
8L	92	62	17,20	3	009100588
10L	132	102	18,60	3	009100590



910BP/SB6L 117,00 1 009100596  
4L-5L-6L-7L-8L-10L mm

## 910ME

chaves de caixa com ponta macho hexagonal



mm	Ø mm	L mm	L1 mm	€	🔧	📦
4	18	62	15	17,30	5	009100504
5	18	62	15	17,30	5	009100505
6	18	62	15	17,30	5	009100506
7	18	62	15	17,60	5	009100507
8	19	62	15	17,60	5	009100508
10	20	62	15	17,60	5	009100510
12	20	62	15	17,60	5	009100512

3/8"



910ME/SB5 98,00 1 009100515  
4-5-6-8-10 mm

## 910PE/AS

chaves de caixa para parafusos sextavados

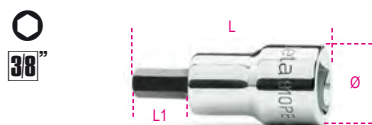

"	Ø mm	L mm	L1 mm	€	🔧	📦
1/8	18,5	50	20	24,70	2	009100531
5/32	18,5	50	20	24,70	2	009100532
3/16	18,5	50	20	24,70	2	009100533
7/32	18,5	50	20	24,70	2	009100534
1/4	18,5	50	20	24,70	2	009100535
5/16	18,5	50	20	24,70	2	009100536
3/8	18,5	50	20	27,50	2	009100537

## 910PT

chaves de caixa com pontas de 5 nervuras e furo central

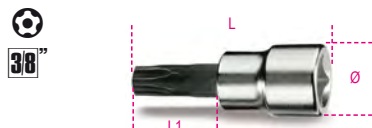

"	Ø mm	L mm	L1 mm	€	🔧	📦
PT40	20	50	20	22,90	3	009100540
PT45	20	50	20	23,50	3	009100545
PT50	20	50	20	28,00	3	009100550

1/4"



910PT/SB8 189,00 1 009100558  
PT10-PT15-PT20-PT25  
PT30-PT40-PT45-PT50

## 910TX

chaves de caixa com ponta macho de perfil Torx®

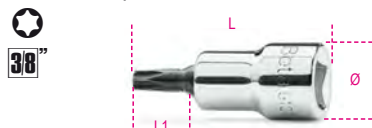

"	Ø mm	L mm	L1 mm	€	🔧	📦
T15	18,5	50	20	18,90	5	009100519
T20	18,5	50	20	18,90	5	009100520
T25	18,5	50	20	18,90	5	009100521
T27	18,5	50	20	18,90	5	009100522
T30	18,5	50	20	18,90	5	009100523
T40	18,5	50	20	18,90	5	009100524
T45	18,5	50	20	18,90	3	009100525
T50	18,5	50	20	18,90	3	009100526

3/8"



910TX/SB6 125,00 1 009100530  
T15-T20-T25  
T27-T30-T40

## 910XZN

chaves de caixa perfil XZN®



"	L mm	€	🔧	📦
M4	50	20,30	3	009100559
M5	50	20,30	3	009100560
M6	50	20,30	3	009100561
M8	50	20,30	3	009100563
M10	50	21,50	3	009100565

## 910CF

chaves pé de galo quadra fêmea de 3/8"



"	A mm	L mm	€	🔧	📦
10	21,3	32,3	12,30	2	009100135
11	23,1	34,3	12,30	2	009100136
12	25,5	36,2	13,80	2	009100137
13	26,9	37,4	13,80	2	009100138
14	30,2	40,0	14,70	2	009100139
15	33,3	41,3	15,30	2	009100140
16	33,3	41,3	16,60	2	009100141
17	38,1	46,5	19,20	2	009100142
18	38,1	46,5	19,20	2	009100143
19	39,6	48,0	21,00	2	009100144

3/8"



910CF/SB10 175,00 1 009100147  
10-11-12-13-14-15  
16-17-18-19 mm

## 910/15

redução quadra fêmea de 3/8" para quadra macho de 1/4"



UNI/ISO 3316 DIN 3123

L mm	Ø mm	€	🔧	📦
30	17,0	10,60	5	009100810



Aplice sempre uma força de aperto regular e progressiva, a fim de evitar a ruptura do material e de se proteger de um possível acidente

## 910/16

adaptador quadra fêmea de 3/8" para quadra macho de 1/2"

3/8"



UNI/ISO 3316 DIN 3123

L mm	Ø mm	3/8"	1/2"	€	3	009100814
32	18,0			11,10	5	009100814

## 910/20 - 910/21 - 910/22

extensões com quadras macho e fêmea de 3/8"

3/8"

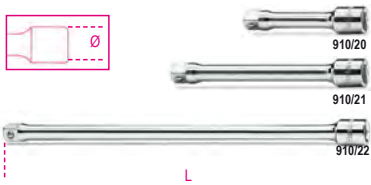

UNI/ISO 3316 DIN 3123

	L mm	Ø mm	€	3	009100820
910/20	75	17	9,10	5	009100820
910/21	125	17	13,10	5	009100822
910/22	250	17	17,30	5	009100826

## 910AN

extensões com quadras macho angulares e fêmea de 3/8"

3/8"

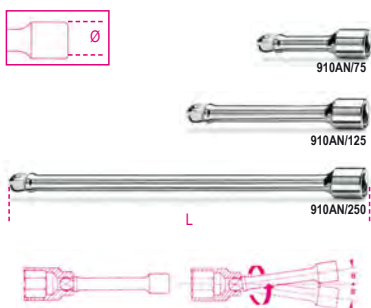

	L mm	Ø mm	€	3	009100827
910AN/75	75	17	12,90	3	009100827
910AN/125	125	17	16,10	3	009100828
910AN/250	250	17	24,00	3	009100829

## 910/25

cardan com quadras macho e fêmea de 3/8"

3/8"



UNI/ISO 3316 DIN 3123

L mm	Ø mm	€	3	009100830
54,6	19	23,70	5	009100830

## 910M/35

cabo articulado com punho metálico, quadra de 3/8"

3/8"



UNI/ISO 3315 DIN 3122

L mm	€	3	009100839
250	65,50	3	009100839

## 910/36A

cabo articulado com punho quadra de 3/8"

3/8"



UNI/ISO 3315 DIN 3122

L mm	L1 mm	€	3	009100845
255	154	46,00	3	009100845

## 910/40

extensão articulada com punho em T quadra de 3/8"

3/8"



L mm	L1 mm	€	3	009100850
420	175	49,00	3	009100850

## 910/42

cabo T corrediço, quadra de 3/8"

3/8"

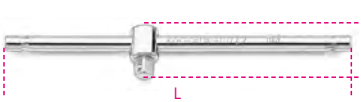

UNI/ISO 3315 DIN 3122

L mm	A mm	€	5	009100854
210	30,5	15,60	5	009100854

## 910/46

manivela quadra macho de 3/8"

3/8"

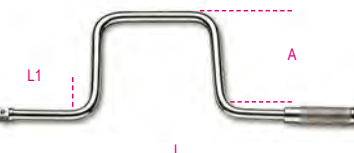

UNI/ISO 3315 DIN 3122

L mm	L1 mm	A mm	€	1	009100862
315	80	115	30,50	1	009100862

## 910/55

roquete reversível quadra macho 3/8", mecanismo 72 dentes

72

3/8"



UNI/ISO 3315 DIN 3122

L mm	Ø mm	A mm	€	3	009101155
207	31	33	57,00	3	009101155

Mecanismos rotativos de substituição para roquetes

111

## 910M/55

roquete reversível com punho metálico quadra de 3/8"

3/8"



DIN 3122 - UNI ISO 3315

L mm	Ø mm	A mm	€	2	009100875
178	30	26	76,50	2	009100875

## 910M/56

roquete reversível articulado com punho metálico, quadra de 3/8"

3/8"



L mm	Ø mm	A mm	€	2	009100887
265	31	29	105,00	2	009100887



## 910/58

roquete reversível quadra 3/8"  
com punho rotativo,  
52 dentes

- Funcionamento através de punho rotativo
- Botão de desbloqueio da chave de caixa
- Sistema de inversão através de porca na cabeça do roquete
- Punho bi-material



L mm	Ø mm	A mm	€	1	009100884
222	37	38,5	86,00		

## 910.../C10

jogo com 10 chaves de caixa  
e 2 acessórios



910A/C10	€	1	009100909
	183,00		

910A	6 - 7 - 8 - 10 - 11 - 12 13 - 14 - 17 - 19 mm
910/21	125 mm
910/55	

270x120x45 mm - 1,3 kg

910B/C10	€	1	009100910
	183,00		

910B	6 - 7 - 8 - 10 - 11 - 12 13 - 14 - 17 - 19 mm
910/21	125 mm
910/55	

270x120x45 mm - 1,3 kg



## 910A/C16...

jogo com 16 chaves de caixa de 12 faces  
e 5 acessórios



910A/C16	€	1	009100936
	295,00		

910A	6 - 7 - 8 - 9 - 10 - 11 - 12 - 13 14 - 15 - 16 - 17 - 18 - 19 21 - 22 mm
910/21	125 mm
910/22	250 mm
910/25	
910/42	
910/55	

335x145x60 mm - 2,3 kg

9899 910C16	€	1	098990134
	15,20		

Tabuleiro maleável, vazio

## 910B/C16...

jogo com 16 chaves de caixa de 12 faces  
e 5 acessórios



910B/C16	€	1	009100937
	295,00		

910B	6 - 7 - 8 - 9 - 10 - 11 - 12 - 13 14 - 15 - 16 - 17 - 18 - 19 21 - 22 mm
910/21	125 mm
910/22	250 mm
910/25	
910/42	
910/55	

335x145x60 mm - 2,3 kg

9899 910C16	€	1	098990134
	15,20		

Tabuleiro maleável, vazio

## 910A/C17

jogo com 17 chaves de caixa hexagonais  
e 9 acessórios



910A/C17	€	1	009100938
	439,00		

910A	6 - 7 - 8 - 9 - 10 - 11 - 12 - 13 14 - 15 - 16 - 17 - 18 - 19 - 20 21 - 22 mm
910/15	□ 3/8 - ■ 1/4
910/16	□ 3/8 - ■ 1/2
910/21	125 mm
910/22	250 mm
910/25	
910/36A	
910/42	
910/46	
910/55	

420x280x60 mm - 4,0 kg

## 910.../C29

jogo com 17 chaves de caixa,  
12 pontas e 5 acessórios



910A/C29	€	1	009100944
	505,00		

910A	6 - 7 - 8 - 9 - 10 - 11 - 12 - 13 14 - 15 - 16 - 17 - 18 - 19 - 20 21 - 22 mm
910LP	1x5,5 - 1,2x6,5 - 1,2x8 mm
910PH	PH1 - PH2 - PH3
910PE	3 - 4 - 5 - 6 - 8 - 10 mm
910/21	125 mm
910/22	250 mm
910/25	
910/42	
910/55	

420x185x60 mm - 3,5 kg

910B/C29	€	1	009100945
	505,00		

910B	6 - 7 - 8 - 9 - 10 - 11 - 12 - 13 14 - 15 - 16 - 17 - 18 - 19 - 20 21 - 22 mm
910LP	1x5,5 - 1,2x6,5 - 1,2x8 mm
910PH	PH1 - PH2 - PH3
910PE	3 - 4 - 5 - 6 - 8 - 10 mm
910/21	125 mm
910/22	250 mm
910/25	
910/42	
910/55	

420x185x60 mm - 3,5 kg





## 910AS/C13...

jogo com 13 chaves de caixa de 12 faces e 5 acessórios

38"



**910AS/C13** € 296,00 1 009100925

910AS	1/4 - 5/16 - 11/32 - 3/8 - 7/16 1/2 - 9/16 - 19/32 - 5/8 - 11/16 3/4 - 13/16 - 7/8
910/21	125 mm
910/22	250 mm
910/42	
910/25	
910/55	
335x145x60 mm - 2,3 kg	

## 910AS/MBM-C18

jogo com 13 chaves de caixa de 12 faces e 5 acessórios

38"



**910AS/MBM-C18** € 308,00 1 009100926

910AS	1/4 - 5/16 - 11/32 - 3/8 - 7/16 1/2 - 9/16 - 19/32 - 5/8 - 11/16 3/4 - 13/16 - 7/8
910/21	125 mm
910/22	250 mm
910/25	
910/42	
910M/55	
335x145x60 mm - 2,5 kg	



## 910A/C16HR

Jogo de 16 chaves de caixa sextavadas e 5 acessórios em módulo soft e caixa metálica

38"



**910A/C16HR** € 323,00 1 009100935

• roquete com punho rotativo

910A	6 - 7 - 8 - 9 - 10 - 11 - 12 - 13 14 - 15 - 16 - 17 - 18 - 19 21 - 22 mm
910/21	125 mm
910/22	250 mm
910/25	
910/42	210 mm
910/58	
335x145x60 mm - 2,4 kg	

## 920A

chaves de caixa boca sextavadas

12"



UNI/ISO 2725 DIN 3124

Ø	Ø	L	Ø1	€		
mm	mm	mm	mm			
8	12,4	38	21,7	6,00	10	009200008
9	13,5	38	21,7	6,00	10	009200009
10	14,9	38	21,7	6,00	10	009200010
11	16,1	38	21,7	6,00	10	009200011
12	17,5	38	21,7	6,00	10	009200012
13	18,7	38	21,7	6,30	10	009200013
14	20,1	38	21,7	6,30	10	009200014
15	21,5	38	22,5	6,30	10	009200015
16	22,7	38	23,7	7,00	10	009200016
17	24,1	38	23,1	7,00	10	009200017
18	25,3	39	24,0	7,00	10	009200018
19	26,6	39	24,0	7,00	10	009200019
20	27,8	40	25,0	7,70	5	009200020
21	28,8	40	25,0	7,70	5	009200021
22	29,9	41	26,0	7,70	5	009200022
23	30,8	42	26,0	9,00	5	009200023
24	32,2	43	27,0	9,00	5	009200024
25	33,2	44	27,0	9,00	5	009200025
26	34,7	45	28,0	9,20	5	009200026
27	36,2	46	29,0	9,20	5	009200027
28	37,2	47	30,0	9,20	5	009200028
29	38,6	48	31,0	9,70	5	009200029
30	40,2	48	32,0	9,70	5	009200030
32	42,3	49	34,0	10,10	5	009200032

12"



**920A/SB13** € 105,00 1 009200040  
10-11-12-13-14-15-16  
17-18-19-20-21-22 mm

12"



**920A/SB8** € 86,00 1 009200042  
23-24-25-26-27-28-30-32 mm

## 920MC

chaves de caixa sextavadas, coloridas

12"

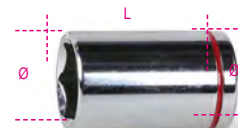

Ø	Ø	L	Ø1	€		
mm	mm	mm	mm			
8	13,2	38	22	6,60	5	009202008
10	15,3	38	22	6,60	5	009202010
11	16,5	38	22	6,60	5	009202011
12	17,8	38	22	6,60	5	009202012
13	19,0	38	22	6,80	5	009202013
14	20,3	38	22	6,80	5	009202014
15	21,6	38	22	6,80	5	009202015
16	23,0	38	23	7,70	5	009202016
17	23,9	38	24	7,70	5	009202017
18	25,0	38	25	7,70	5	009202018
19	26,5	38	24	7,70	5	009202019
21	28,8	38	27	8,40	3	009202021
22	29,9	40	28	8,40	3	009202022
24	32,8	40	30	9,80	3	009202024

## 920B

chaves de caixa, boca de 12 faces

12"



UNI/ISO 2725 DIN 3124

Ø	Ø	L	Ø1	€		
mm	mm	mm	mm			
8	12,4	38	21,7	6,00	10	009200108
9	13,5	38	21,7	6,00	10	009200109
10	14,9	38	21,7	6,00	10	009200110
11	16,1	38	21,7	6,00	10	009200111
12	17,5	38	21,7	6,00	10	009200112
13	18,7	38	21,7	6,30	10	009200113
14	20,1	38	21,7	6,30	10	009200114
15	21,5	38	22,5	6,30	10	009200115
16	22,7	38	23,7	7,00	10	009200116
17	24,1	38	23,1	7,00	10	009200117
18	25,3	39	24,0	7,00	10	009200118
19	26,6	39	24,0	7,00	10	009200119
20	27,8	40	25,0	7,70	5	009200120
21	28,8	40	25,0	7,70	5	009200121
22	29,9	41	26,0	7,70	5	009200122
23	30,8	42	26,0	9,00	5	009200123
24	32,2	43	27,0	9,00	5	009200124
25	33,2	44	27,0	9,00	5	009200125
26	34,7	45	28,0	9,20	5	009200126
27	36,2	46	29,0	9,20	5	009200127
28	37,2	47	30,0	9,20	5	009200128
29	38,6	48	31,0	9,70	5	009200129
30	40,2	48	32,0	9,70	5	009200130
32	42,3	49	33,9	10,10	5	009200132

12"



**920B/SB13** € 105,00 1 009200140  
10-11-12-13-14-15-16  
17-18-19-20-21-22 mm



12"

**920B/SB8** € 86,00 1 009200142  
23-24-25-26-27  
28-30-32 mm

## 920AL

chaves de caixa série longa,  
boca hexagonal



12"

UNI/ISO 2725 DIN 3124

Ø mm	Ø mm	L mm	Ø1 mm	€	1	009200626
10	14,7	77	21	16,00	5	009200626
12	17,8	77	21	16,00	5	009200627
13	19,0	77	22	16,00	5	009200628
14	20,3	77	22	16,00	5	009200629
15	21,5	77	22	16,00	5	009200630
16	22,8	77	22	17,10	5	009200631
17	24,0	77	23	17,10	5	009200632
18	25,0	77	24	18,00	5	009200633
19	26,5	77	25	18,00	5	009200634
21	29,0	77	27	20,00	5	009200635
22	30,0	77	28	20,00	5	009200636
23	31,5	77	29	20,00	5	009200637
24	32,8	77	30	23,00	5	009200638
27	36,5	77	33	23,90	3	009200639
30	40,0	77	36	29,00	3	009200640
32	42,8	77	38	29,50	3	009200641
36	48,0	77	41	47,50	3	009200642



12"

**920AL/SB11** € 206,00 1 009200644  
10-12-13-14-15-16  
17-18-19-21-22 mm

## 920BL

chaves de caixa série longa,  
boca de 12 faces



12"

UNI/ISO 2725 DIN 3124

Ø mm	Ø mm	L mm	Ø1 mm	€	1	009200310
10	14,7	77	21	16,00	5	009200310
12	17,8	77	21	16,00	5	009200312
13	19,0	77	22	16,00	5	009200313
14	20,3	77	22	16,00	5	009200314
15	21,5	77	22	16,00	5	009200315
16	22,8	77	22	17,10	5	009200316
17	24,0	77	23	17,10	5	009200317
18	25,0	77	24	18,00	5	009200318
19	26,5	77	25	18,00	5	009200319
21	29,0	77	27	20,00	5	009200321
22	30,0	77	28	20,00	5	009200322
23	31,5	77	29	20,00	5	009200323
24	32,8	77	30	23,00	5	009200324
27	36,5	77	33	23,90	3	009200327
30	40,0	77	36	29,00	3	009200330
32	42,8	77	38	29,50	3	009200332
36	48,0	77	41	47,50	3	009200336



12"

**920BL/SB11** € 206,00 1 009200338  
10-12-13-14-15-16-17-18  
19-21-22 mm

## 920A/AS

chaves de caixa boca hexagonal



12"

Ø mm	Ø mm	L mm	Ø1 mm	€	1	009200270
3/8	14,6	37	21	7,10	2	009200270
7/16	16,5	37	21	7,10	3	009200272
1/2	19,0	37	22	7,30	3	009200273
9/16	20,3	37	22	7,30	3	009200274
19/32	21,0	37	22	7,80	3	009200275
5/8	22,8	37	22	7,80	3	009200276
11/16	25,0	37	24	8,10	3	009200277
3/4	26,5	38	25	8,10	3	009200279
25/32	28,0	38	26	9,10	3	009200280
13/16	29,0	38	27	9,10	3	009200281
7/8	30,0	40	28	9,10	3	009200282
15/16	32,8	42	30	9,70	3	009200284
1	35,0	42	32	9,70	3	009200285
1.1/16	36,5	43	33	10,70	2	009200287
1.1/8	39,0	43	35	10,90	2	009200289
1.3/16	41,0	46	36	11,70	2	009200290
1.1/4	42,8	46	38	11,90	2	009200292



12"

**920A-AS/SB11** € 106,00 1 009200295  
3/8-7/16-1/2-9/16-5/8  
11/16-3/4-13/16-7/8  
15/16-1

## 920AS

chaves de caixa, boca de 12 faces



12"

Ø mm	Ø mm	L mm	Ø1 mm	€	1	009200201
3/8	14,9	38	21,7	7,10	3	009200201
7/16	16,1	38	21,7	7,10	3	009200202
1/2	18,7	38	21,7	7,30	3	009200203
9/16	20,1	38	21,7	7,30	3	009200204
5/8	22,7	38	22,5	7,80	3	009200206
19/32	21,5	38	23,7	7,80	3	009200207
11/16	25,3	39	24,0	8,10	3	009200208
3/4	26,6	39	24,0	8,10	3	009200209
25/32	27,8	40	25,0	9,10	3	009200210
13/16	28,8	40	25,0	9,10	3	009200211
7/8	29,9	41	26,0	9,10	3	009200212
15/16	32,2	43	27,0	9,70	3	009200214
1	34,2	45	28,0	9,70	3	009200216
1.1/16	36,2	46	29,0	10,70	2	009200217
1.1/8	38,6	48	31,0	10,90	2	009200218
1.3/16	40,2	48	32,0	11,70	2	009200219
1.1/4	42,3	49	33,5	11,90	2	009200220



12"

**920AS/SB11** € 106,00 1 009200225  
3/8-7/16-1/2-9/16-5/8  
11/16-3/4-13/16-7/8  
15/16-1

## 920AS/L

chaves de caixa série longa  
boca hexagonal



12"

Ø mm	Ø mm	L mm	Ø1 mm	€	1	009200352
1/2	19,0	77	22	22,00	2	009200352
9/16	20,3	77	22	22,00	2	009200353
5/8	22,8	77	22	22,00	2	009200355
11/16	25,0	77	24	23,40	2	009200357
3/4	26,5	77	25	23,90	2	009200358
13/16	29,0	77	27	28,50	2	009200360
7/8	30,0	77	28	28,50	2	009200361
15/16	32,8	77	30	29,50	2	009200362
1	35,0	77	32	30,00	2	009200363
1.1/16	36,5	77	33,0	33,00	2	009200364
1.1/8	37,8	77	34	34,00	2	009200365



12"

**920ASL/SB11** € 312,00 1 009200369  
1/2-9/16-5/8-11/16  
3/4-13/16-7/8-15/16  
1-1.1/8-1.1/16

## 920U

chaves de caixa para bloqueio de embraiagem



12"

Ø mm	"	E	M	L mm	€	1	009201710
10	3/8	E12	M12	38	6,30	5	009201710
11	7/16	E14	M14	38	6,30	5	009201711
12	15/32	E16		38	6,30	5	009201712
13	1/2		M16	38	6,60	5	009201713
14	9/16	E18	M18	38	6,60	5	009201714
15	19/32			38	6,60	5	009201715
16	5/8	E20		38	7,40	5	009201716
17				38	7,40	5	009201717
18		E22		38	7,40	5	009201718
19	3/4	E24		38	7,40	5	009201719
20	25/32			38	8,10	3	009201720
21				38	8,10	3	009201721
22	7/8			38	8,10	3	009201722
24	15/16			38	9,40	3	009201724
27	1.1/16			42	9,70	3	009201727
30	1.1/8			44	10,30	3	009201730
32	1.1/4			44	10,80	3	009201732



12"

**920U/SB13** € 110,00 1 009201740  
10-11-12-13-14-15-16  
17-18-19-20-21-22 mm

12"



920U/SB4  
24-27-30-32 mm

€ 47,50

1 009201744



12"



920FTX-LSB6  
E10-E12-E14  
E16-E18-E20

€ 132,00

1 009200409

## 920FTX

chaves de caixa para parafusos de perfil Torx®



12"



	Ø mm	L mm	Ø1 mm	€		
E10	13,2	36	21	9,70	5	009200380
E12	15,0	37	21	9,70	5	009200381
E14	16,3	37	21	9,70	5	009200382
E16	18,8	37	22	9,70	5	009200383
E18	20,4	37	22	9,70	5	009200384
E20	22,9	37	22	10,60	5	009200385
E22	25,0	37	24	12,20	3	009200387
E24	26,5	40	25	13,80	3	009200388



12"



920FTX/SB6  
E10-E12-E14  
E16-E18-E20

€ 68,50

1 009200390



12"



920FTX/C8  
E10-E12-E14-E16  
E18-E20-E22-E24

€ 141,00

1 009200391

270X120X45 mm - 1 kg

## 920FTX/L

chaves de caixa série longa para parafusos de perfil Torx®



12"



	Ø mm	L mm	Ø1 mm	€		
E10	13,2	77	21,0	20,30	5	009200400
E12	15,0	77	21,0	20,30	5	009200401
E14	16,3	77	21,0	20,30	5	009200402
E16	18,8	77	21,8	20,30	3	009200403
E18	20,4	77	21,8	20,30	3	009200404
E20	22,9	77	22,0	20,30	3	009200405

## 920PH

chaves de caixa com ponta de perfil Phillips®



12"



PH	Ø mm	L mm	L1 mm	€		
1	22,5	56	18	13,90	3	009200471
2	22,5	56	18	13,90	3	009200472
3	22,5	56	18	13,90	3	009200473
4	22,5	56	18	13,90	3	009200474



12"



920PH/SB4  
PH1-PH2-PH3-PH4

€ 63,00

1 009200479

## 920LH/SB7

chaves de caixa com ponta de perfil Phillips®



12"



920LH/SB7

€ 116,00

1 009200478

920LP 1,2x6,5 - 1,2x8  
1,6x9 - 2x12 mm  
920PH PH2 - PH3 - PH4

## 920PE

chaves de caixa com ponta macho hexagonal



12"

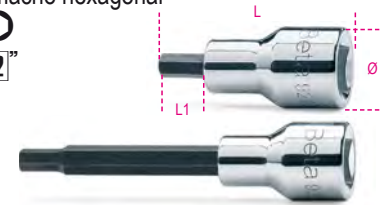

DIN 7422

mm	Ø mm	L mm	L1 mm	€		
3	22,5	58	20	12,60	5	009200410
4	22,5	58	20	12,60	5	009200412
5	22,5	58	20	12,60	5	009200414
5L	22,5	100	62	13,80	5	009200415
6	22,5	58	20	12,60	5	009200417
6L	22,5	100	62	13,80	5	009200418
7	22,5	58	20	12,60	5	009200420
7L	22,5	100	62	13,80	5	009200421
8	22,5	58	20	12,60	5	009200423
8L	22,5	100	62	13,80	5	009200424
9	22,5	58	20	12,60	5	009200425
9L	22,5	140	102	14,50	5	009200426
10	22,5	58	20	12,60	5	009200428
10L	22,5	140	102	14,50	5	009200429
12	23,0	58	20	14,70	5	009200432
12L	22,5	140	102	16,80	5	009200433
14	23,0	58	20	14,70	5	009200434
14L	22,5	140	102	16,80	5	009200435
17	29,5	60	22	18,00	5	009200437
19	29,5	60	22	18,00	5	009200439



12"



920PE/SB9  
4-5-6-8-10 mm  
5L-6L-8L-10L mm

€ 132,00

1 009200441



12"



920PE/C10  
4-5-6-7-8-10  
12-14-17-19 mm

€ 209,00

1 009200443

270X120X45 mm - 1,5 kg

9899 920PE/C10

€ 15,20

1 098990135

Tabuleiro maleável, vazio





## 920PE/AS

chaves de caixa com ponta macho hexagonal



"	Ø mm	L mm	L1 mm	€	📦	📄
1/8	22,5	58	20	14,80	2	009200460
3/16	22,5	58	20	14,80	2	009200461
1/4	22,5	58	20	14,80	2	009200463
3/8	22,5	58	20	14,80	2	009200464
1/2	22,5	60	20	16,20	2	009200465
3/4	22,5	60	20	17,30	1	009200468



920PE-AS/SB6 103,00 1 009200469  
1/8-3/16-1/4-3/8-1/2-3/4

## 920BP

chaves de caixa com ponta macho hexagonal esférico

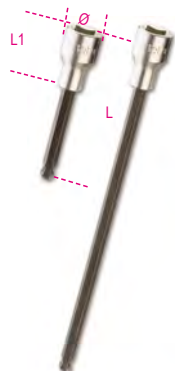

mm	Ø mm	L mm	L1 mm	€	📦	📄
5L	22,5	100	62	15,90	5	009200490
5XL	22,5	240	202	20,40	1	009200495
6L	22,5	100	62	15,90	5	009200491
6XL	22,5	240	202	20,40	1	009200496
7L	22,5	100	62	15,90	5	009200492
8L	22,5	100	62	15,90	5	009200493
8XL	22,5	240	202	20,40	1	009200497
10L	22,5	140	102	17,30	5	009200494



920BP/SB8 154,00 1 009200500  
5L-6L-7L-8L-10L mm  
5XL-6XL-8XL mm

## 920ME

chaves de caixa com ponta macho hexagonal



mm	Ø mm	L mm	L1 mm	€	📦	📄
5	21	75	15,5	14,80	5	009200505
6	21	75	15,5	14,80	5	009200506
7	21	75	15,5	14,80	5	009200507
8	21	75	15,5	14,80	5	009200508
10	23	75	15,5	15,40	5	009200510
12	24	75	15,5	17,80	5	009200512
14	24	75	15,5	18,30	5	009200514
17	24	75	15,5	18,30	5	009200517



920ME/SB7 125,00 1 009200519  
5-6-8-10-12-14-17 mm



920ME/C7 171,00 1 009200518  
5-6-8-10-12-14-17 mm  
250X100X35 mm - 1,4 kg

## 920TX

chaves de caixa com ponta macho de perfil Torx®



mm	Ø mm	L mm	L1 mm	€	📦	📄
T20	22,5	58	20	15,40	5	009200520
T20L	22,5	120	82	19,80	3	009200530
T25	22,5	58	20	15,40	5	009200521
T25L	22,5	120	82	19,80	3	009200531
T27	22,5	58	20	15,40	5	009200522
T27L	22,5	120	82	19,80	3	009200533
T30	22,5	58	20	15,40	5	009200523
T30L	22,5	120	82	19,80	3	009200534
T40	22,5	58	20	15,40	5	009200524
T40L	22,5	120	82	19,80	3	009200535
T45	22,5	58	20	15,40	5	009200525
T45L	22,5	120	82	19,80	3	009200537
T50	22,5	58	20	15,40	5	009200526
T50L	23,0	140	102	19,80	3	009200538
T55	23,0	58	20	20,70	3	009200527
T55L	23,0	140	102	28,00	3	009200539
T60	23,0	58	20	20,70	3	009200528
T60L	23,0	140	102	28,00	3	009200540
T70L	23,0	120	82	28,00	3	009200541



920TX/SB9 162,00 1 009200532  
T20-T25-T27-T30-  
T40-T45-T50-T55-T60



920TX-L/SB10 236,00 1 009200545  
T20L-T25L-T27L-T30L-T40L-  
T45L-T50L-T55L-T60L-T70L



920TX/C9 218,00 1 009200546  
T20-T25-T27-T30-T40  
T45-T50-T55-T60

270X120X45 mm - 1,2 kg



9899 920TX/C9 15,20 1 098990136  
Tabuleiro maleável, vazio

## 920RTX

chaves de caixa com ponta macho de perfil Tamper Resistant Torx®



mm	Ø mm	L mm	L1 mm	€	📦	📄
T20	22,5	58	20	16,50	5	009200370
T25	22,5	58	20	16,50	5	009200371
T27	22,5	58	20	16,50	5	009200372
T30	22,5	58	20	16,50	5	009200373
T40	22,5	58	20	16,50	5	009200374



920RTX/SB5 91,00 1 009200378  
T20-T25-T27-T30-T40



## 920XZN

chaves de caixa com ponta macho de perfil XZN(R)

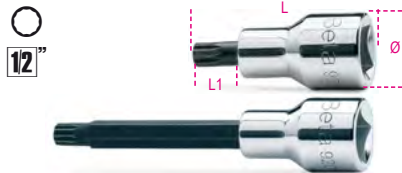

DIN 2324

Ø	mm	L	L1	mm	mm	€			
M4	22,5	58	20	16,60	3	009200559			
M5	22,5	58	20	16,60	3	009200560			
M6	22,5	58	20	16,60	3	009200561			
M6L	22,5	100	62	18,90	3	009200562			
M8	22,5	58	20	16,60	3	009200563			
M8L	22,5	100	62	18,90	3	009200564			
M9	22,5	58	20	16,60	3	009200582			
M9L	22,5	100	62	18,90	3	009200583			
M10	22,5	58	20	16,80	3	009200565			
M10L	22,5	100	62	18,90	3	009200566			
M12	22,5	58	20	17,30	3	009200568			
M12L	22,5	100	62	19,40	3	009200569			
M14	23,0	58	20	17,30	3	009200571			
M14L	23,0	100	62	19,40	3	009200572			
M16	23,0	58	20	21,60	3	009200573			
M18	23,0	58	20	22,00	3	009200574			



920XZN/SB7  
M4-M5-M6-M8  
M10-M12-M14

€ 129,00 1 009200579



920XZN/SB12  
M5-M6-M8-M10-M12  
M14-M16-M6L-M8L  
M10L-M12L-M14L

€ 235,00 1 009200577



920XZN-L/S5  
M6L-M8L-M10L  
M12L-M14L

€ 95,50 1 009200578

## 920ES

chaves de caixa com pontas de 6 caneluras



UNI 9326

Ø	mm	Ø	L	L1	mm	mm	€		
7	(6R)	58	20	23,00	5	009200587			
7XL	(6R)	240	202	32,50	1	009200607			
9	(8R)	58	20	23,00	5	009200589			
9XL	(8R)	240	202	32,50	1	009200609			
10	(8S)	58	20	23,00	5	009200590			
10XL	(8S)	240	202	32,50	1	009200610			
11	(10R)	58	20	23,00	5	009200591			
11XL	(10R)	240	202	32,50	1	009200611			
12L	(10S)	100	62	26,00	3	009200592			

Ø	mm	Ø	L	L1	mm	mm	€		
12XL	(10S)	240	202	35,50	1	009200612			
14L	(12S)	100	62	26,00	3	009200594			
14XL	(12S)	240	202	35,50	1	009200614			
16L	(14R)	100	62	26,00	3	009200596			
16XL	(14R)	240	202	35,50	1	009200616			



920ES/SB7  
7-9-10-11-12L-14L-16L

€ 181,00 1 009200598



920ES-XL/SB7  
7XL-9XL-10XL-11XL  
12XL-14XL-16XL

€ 248,00 1 009200618

## PM 1/2-Q5



PM 1/2-Q5 72,570

## 920/15

redução quadra fêmea de 1/2" para quadra macho de 3/8"



UNI/ISO 3316 DIN 3123

L	mm	□	■	Ø	mm	€		
42	1/2	3/8	22,0	9,90	5	009200810		



Aplique sempre uma força de aperto regular e progressiva, a fim de evitar a ruptura do material e de se proteger de um possível acidente

## 920/16

adaptador quadra fêmea de 1/2" para quadra macho de 3/4"



UNI/ISO 3316 DIN 3123

L	mm	□	■	Ø	mm	€		
46	1/2	3/4	26	13,00	5	009200814		

## 920/20=920/23

extensões com quadras macho e fêmea de 1/2"



UNI/ISO 3316 DIN 3123

	L	Ø	mm	mm	€		
920/20	75	22	12,10	5	009200818		
920/21	125	22	14,80	5	009200822		
920/22	255	22	16,80	5	009200826		
920/23	375	22	22,50	2	009200827		

## 920AN

extensões com quadras macho angulares e fêmea de 1/2"

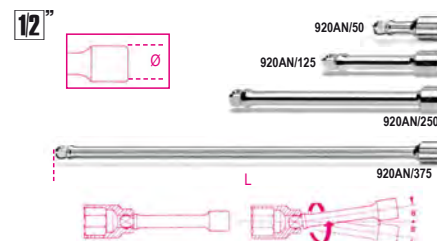

	L	Ø	mm	mm	€		
920AN/50	50	22	13,00	5	009200833		
920AN/125	125	22	17,90	5	009200834		
920AN/250	250	22	25,00	3	009200835		
920AN/375	375	22	33,50	3	009200836		

## 920/25

cardan com quadras macho e fêmea de 1/2"



UNI/ISO 3316 DIN 3123

L	mm	Ø	mm	€		
75	27	23,40	5	009200830		

## 920/35A

cabos articulados com punho quadra de 1/2"



UNI/ISO 3315 DIN 3122

L	L1	mm	mm	€		
285	160	47,00	3	009200846		

## 920M/35

cabo articulado com punho metálico  
quadra de 1/2"



UNI/ISO 3315 DIN 3122

L	€	Q	Art
mm 380	67,50	2	009200845

## 920M/35L

punho articulado quadra macho 1/2"  
com cabo metálico, série longa



L	€	Q	Art
mm 600	102,00	1	009200843



Aplique sempre uma força de aperto regular e progressiva, a fim de evitar a ruptura do material e de se proteger de um possível acidente

## 920/36A

cabo articulado com punho  
quadra de 1/2"



UNI/ISO 3315 DIN 3122

L	L1	€	Q	Art
mm 408	mm 283	53,00	2	009200847

## 920/38

cabo articulado extensível com punho, quadra 1/2"



L	L max	€	Q	Art
mm 262	mm 402	80,00	1	009200839



# Beta



## 920/40

extensão articulada com punho em T  
quadra de 1/2"



L	L1	€	Q	Art
mm 490	mm 230	55,00	2	009200850

## 920/42

cabo T corredeço, quadra de 1/2"

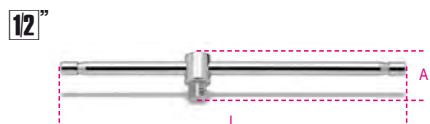

L	A	€	Q	Art
mm 305	mm 42	16,60	5	009200854

## 920/44

cabo angular quadra de 1/2"



L	L1	€	Q	Art
mm 230	mm 60	24,30	3	009200858

## 920/46

manivela quadra macho de 1/2"

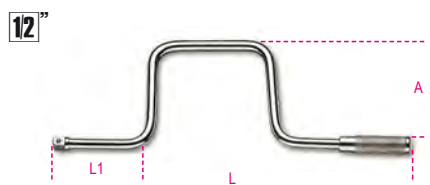

L	L1	A	€	Q	Art
mm 385	mm 110	mm 160	30,00	1	009200862

## 920/50

roquete simples quadra 1/2",  
mecanismo 72 dentes



L	Ø	A	€	Q	Art
mm 271	mm 40	mm 40	53,50	3	009201150

## 920/50F

roquete simples quadra fêmea de 1/2",  
mecanismo de 72 dentes



UNI/ISO 3315 DIN 3122

L	Ø	A	€	Q	Art
mm 271	mm 40	mm 24	49,00	2	009201151

## 920/55

roquete reversível quadra macho de 1/2",  
mecanismo de 72 dentes



UNI/ISO 3315 DIN 3122

L	Ø	A	€	Q	Art
mm 271	mm 40	mm 41	57,00	3	009201155

## 920/55Q

roquete reversível quadra macho de 1/2",  
mecanismo de 48 dentes



UNI/ISO 3315 DIN 3122

L	Ø	A	€	Q	Art
mm 271	mm 40	mm 41	57,00	3	009201156

## 920/55X

roquete reversível quadra macho 1/2",  
mecanismo 72 dentes



UNI/ISO 3315 DIN 3122

L	Ø	A	€	Q	Art
mm 207	mm 31	mm 33	48,50	3	009201158



## 920/55LC

roquete reversível quadra macho de 1/2",  
"Locking System",  
mecanismo de 72 dentes

72



UNI/ISO 3315 DIN 3122

L mm	Ø mm	A mm	€		
271	40	41	66,50	2	009201159

## 920M/55

roquete reversível com punho metálico  
quadra de 1/2"

12"



72



L mm	Ø mm	A mm	€		
253	38	35	72,00	1	009200893

## 920/56A

roquete reversível articulado  
quadra de 1/2" de 72 dentes

72



L mm	Ø mm	A mm	€		
315	40	43	92,00	1	009200911

## 920M/56

roquete reversível articulado  
com punho metálico, quadra de 1/2"

12"



72

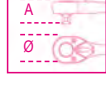

L mm	Ø mm	A mm	€		
330	38	35,7	96,00	2	009200894



## 920/58

roquete reversível quadra 1/2"  
com punho rotativo,  
52 dentes

- Funcionamento através de punho rotativo
- Botão de desbloqueio da chave de caixa
- Sistema de inversão através de porca na cabeça do roquete
- Punho bi-material

12"



L mm	Ø mm	A mm	€		
281	42,5	45	84,50	1	009200926

### Mecanismos rotativos de substituição para roquetes

111

## 920.../C11

jogo com 11 chaves de caixa  
e 2 acessórios

12"



920A/C11	€		
	218,00	1	009200921

920A	10 - 12 - 13 - 14 - 15 - 16 17 - 18 - 19 - 21 - 22 mm
920/22	255 mm
920/50	

420x185x60 mm - 2,5 kg

920B/C11	€		
	218,00	1	009200922

920B	10 - 12 - 13 - 14 - 15 - 16 17 - 18 - 19 - 21 - 22 mm
920/22	255 mm
920/50	

420x185x60 mm - 2,5 kg

## 920.../C12...

jogo com 12 chaves de caixa  
e 5 acessórios

12"



920A/C12X	€		
	318,00	1	009200933

920A	10 - 11 - 12 - 13 - 14 - 17 - 19 22 - 24 - 27 - 30 - 32 mm
920/21	125 mm
920/22	255 mm
920/25	
920/42	
920/55	

420x185x60 mm - 4,2 kg

9899 920C12	€		
Tabuleiro maleável, vazio	15,20	1	098990116

920A/C12	€		
	313,00	1	009200931

920A	10 - 11 - 12 - 13 - 14 - 17 - 19 22 - 24 - 27 - 30 - 32 mm
920/21	125 mm
920/22	255 mm
920/25	
920/42	
920/50	

420x185x60 mm - 4,2 kg

9899 920C12	€		
Tabuleiro maleável, vazio	15,20	1	098990116

920B/C12X	€		
	318,00	1	009200934

920B	10 - 11 - 12 - 13 - 14 - 17 - 19 22 - 24 - 27 - 30 - 32 mm
920/21	125 mm
920/22	255 mm
920/25	
920/42	
920/55	

420x185x60 mm - 4,0 kg

9899 920C12	€		
Tabuleiro maleável, vazio	15,20	1	098990116

920B/C12	€		
	313,00	1	009200932

920B	10 - 11 - 12 - 13 - 14 - 17 - 19 22 - 24 - 27 - 30 - 32 mm
920/21	125 mm
920/22	255 mm
920/25	
920/42	
920/50	

420x185x60 mm - 4,0 kg

9899 920C12	€		
Tabuleiro maleável, vazio	15,20	1	098990116

## 920MC/C14

14 chaves de caixa sextavadas coloridas e 5 acessórios

12"



920MC/C14 € 301,00 1 009202964

- 920MC
  - 920/21
  - 920/22
  - 920/25
  - 920/42
  - 920/55
- 420x185x60 mm - 4,2 kg

## 920.../C20...

jogo com 20 chaves de caixa e 5 acessórios

12"



920A/C20X € 394,00 1 009200950

- 920A
  - 920/21
  - 920/22
  - 920/25
  - 920/42
  - 920/55
- 420x185x60 mm - 5,1 kg

9899 920C20 € 15,20 1 098990121  
Tabuleiro maleável, vazio

920A/C20 € 390,00 1 009200948

- 920A
  - 920/21
  - 920/22
  - 920/25
  - 920/42
  - 920/50
- 420x185x60 mm - 5,1 kg

9899 920C20 € 15,20 1 098990121  
Tabuleiro maleável, vazio

920A/C20Q € 394,00 1 009200955

- 920A
  - 920/21
  - 920/22
  - 920/25
  - 920/42
  - 920/55Q
- 420x185x60 mm - 5,1 kg

9899 920C20 € 15,20 1 098990121  
Tabuleiro maleável, vazio

920B/C20 € 390,00 1 009200949

- 920B
  - 920/21
  - 920/22
  - 920/25
  - 920/42
  - 920/50
- 420x185x60 mm - 5,0 kg

9899 920C20 € 15,20 1 098990121  
Tabuleiro maleável, vazio

920B/C20X € 394,00 1 009200951

- 920B
  - 920/21
  - 920/22
  - 920/25
  - 920/42
  - 920/55
- 420x185x60 mm - 5,0 kg

9899 920C20 € 15,20 1 098990121  
Tabuleiro maleável, vazio

## 920.../C21...

jogo com 21 chaves de caixa e 6 acessórios

12"



920A/C21 € 453,00 1 009200952

- 920A
  - 920/21
  - 920/22
  - 920/25
  - 920/42
  - 920/46
  - 920/50
- 420x280x60 mm - 6,5 kg

920B/C21 € 453,00 1 009200953

- 920B
  - 920/21
  - 920/22
  - 920/25
  - 920/42
  - 920/46
  - 920/50
- 420x280x60 mm - 6,4 kg

920B/C21X € 457,00 1 009200984

- 920B
  - 920/21
  - 920/22
  - 920/25
  - 920/42
  - 920/46
  - 920/55
- 420x280x60 mm - 6,4 kg

## 920B/C30Q

jogo com 30 chaves de caixa de 12 faces e 5 acessórios

12"



920B/C30Q € 645,00 1 009200975

- 920B
  - 920BL
  - 920/21
  - 920/22
  - 920/25
  - 920/42
  - 920/55Q
- 420x280x60 mm - 7,6 kg



# Beta

## 920.../C33

jogo com 20 chaves de caixa, 13 pontas e 5 acessórios

12"



920A/C33 € 630,00 1 009200985

	920A	10 - 11 - 12 - 13 - 14 - 15 - 16 17 - 18 - 19 - 20 - 21 - 22 - 23 24 - 26 - 27 - 28 - 30 - 32 mm
	920LP	1,2x8 - 1,6x9 - 2x12 mm
	920PH	PH2 - PH3 - PH4
	920PE	4 - 5 - 6 - 8 - 10 - 12 - 14 mm
	920/21	125 mm
	920/22	255 mm
	920/25	
	920/42	
	920/55	

420x280x60 mm - 6,7 kg

920B/C33 € 630,00 1 009200986

	920B	10 - 11 - 12 - 13 - 14 - 15 - 16 17 - 18 - 19 - 20 - 21 - 22 - 23 24 - 26 - 27 - 28 - 30 - 32 mm
	920LP	1,2x8 - 1,6x9 - 2x12 mm
	920PH	PH2 - PH3 - PH4
	920PE	4 - 5 - 6 - 8 - 10 - 12 - 14 mm
	920/21	125 mm
	920/22	255 mm
	920/25	
	920/42	
	920/55	

420x280x60 mm - 6,7 kg

## 920A/C17M

Jogo de 17 chaves de caixa hexagonal e 5 acessórios em modulo flexível em caixa metálica

12"



920A/C17M € 360,00 1 009200924

	920A	10-11-12-13-14-15-16-17-18 19-20-21-22-24-27-30-32 mm
	920/21	125 mm
	920/22	255 mm
	920/25	
	920/42	305 mm
	920/55	

420x185x60 mm - 5 kg

9899 920C17 € 28,00 1 098990147

920A/C17MR € 394,00 1 009200937

	920/21	125 mm
	920/22	255 mm
	920/25	
	920/42	305 mm
	920/58	

420x185x60 mm 5,1 kg

## 920/C37

jogo com 37 chaves de caixa de 12 faces e 2 acessórios

12"



920/C37 € 595,00 1 009200988

	920B	10 - 11 - 12 - 13 - 14 - 15 - 16 17 - 18 - 19 - 20 - 21 - 22 - 23 24 - 26 - 27 - 28 - 30 - 32 mm
	920AS	3/8 - 7/16 - 1/2 - 9/16 - 19/32 5/8 - 11/16 - 3/4 - 25/32 - 13/16 7/8 - 15/16 - 1 - 1.1/16 - 1.1/8 1.3/16 - 1.1/4
	920/21	125 mm
	920/22	255 mm
	920/25	
	920/42	
	920/55	

420x280x60 mm - 7,5 kg

## 920AS/C10

jogo com 10 chaves de caixa de 12 faces e 2 acessórios

12"



920AS/C10 € 226,00 1 009200919

	920AS	3/8 - 7/16 - 1/2 - 9/16 - 5/8 11/16 - 3/4 - 13/16 - 7/8 - 15/16
	920/22	255 mm
	920/50	

335x145x60 mm - 2,6 kg

## 920AS/C15

jogo com 15 chaves de caixa de 12 faces e 6 acessórios

12"



920AS/C15 € 420,00 1 009200947

	920AS	3/8 - 7/16 - 1/2 - 9/16 - 5/8 - 11/16 3/4 - 13/16 - 7/8 - 15/16 - 1 1.1/16 - 1.1/8 - 1.3/16 - 1.1/4
	920/21	125 mm
	920/22	255 mm
	920/25	
	920/42	
	920/46	
	920/50	

420x280x60 mm - 5,9 kg



## 920AS/C17X

jogo com 17 chaves de caixa de 12 faces e 5 acessórios

12"



920AS/C17X € 393,00 1 009200942

	920AS	3/8 - 7/16 - 1/2 - 9/16 - 19/32 - 5/8 11/16 - 3/4 - 25/32 - 13/16 - 7/8 15/16 - 1 - 1.1/16 - 1.1/8 - 1.3/16 - 1.1/4
	920/21	125 mm
	920/22	255 mm
	920/25	
	920/42	
	920/55	
		420x185x60 mm - 4,8 kg

## 920TX/C17

jogo com 6 pontas, 6 chaves de caixa, 5 chaves de caixa com ponta e 4 acessórios, para parafusos de perfil Torx®



12"



920TX/C17 € 365,00 1 009200989

	861TX	T8 - T10 - T15 - T20 - T25 - T27
	897	
	920TX	T27 - T30 - T40 - T45 - T50
	920FTX	E10 - E12 - E14 - E16 - E18 - E20
	920/20	75 mm
	920/22	255 mm
	920/55	
		420x185x60 mm - 2,9 kg

## 928A

chaves de caixa com boca hexagonal

3/4"



UNI/ISO 2725  
DIN 3124

mm	Ø mm	L mm	Ø1 mm	€	5	10
19	29,2	50	34	18,60	5	009280019
21	30,0	51	34	18,90	5	009280021
22	31,3	53	34	18,90	5	009280022
23	33,3	53	34	19,20	5	009280023
24	34,5	53	34	19,60	5	009280024
26	36,8	55	35	21,00	5	009280026
27	38,0	56	35	21,00	5	009280027
28	39,0	57	35	22,20	3	009280028
29	40,2	58	35	22,60	3	009280029
30	41,5	58	37	23,30	3	009280030
32	44,3	60	37	24,50	3	009280032
33	45,8	60	37	26,00	3	009280033
34	46,8	60	37	26,00	3	009280034
35	48,1	62	38	26,50	3	009280035
36	49,5	64	38	26,50	3	009280036
38	52,0	68	40	29,00	3	009280038
41	56,0	71	40	32,00	3	009280041
46	62,3	75	43	40,00	3	009280046
50	67,4	80	43	47,50	3	009280050
55	73,7	84	48	58,50	1	009280055
60	80,0	87	48	68,00	1	009280060

## 920AS/MBM-C21

jogo com 16 chaves de caixa de 12 faces e 5 acessórios

12"



920AS/MBM-C21 € 398,00 1 009200944

	920AS	3/8 - 7/16 - 1/2 - 9/16 19/32 - 5/8 - 11/16 - 3/4 25/32 - 13/16 - 7/8 - 15/16 1 - 1.1/16 - 1.3/16 - 1.1/4
	920M/55	
	920/21	125 mm
	920/22	255 mm
	920/25	
	920/42	
		420x185x60 mm - 5,0 kg

## 920A/C17HR

17 chaves de caixa sextavadas e 5 acessórios em estojo metálico com tabuleiro rígido

• roquete com punho rotativo

12"



920A/C17HR € 404,00 1 009200939

	920A	10-11-12-13-14-15-16-17-18 19-20-21-22-24-27-30-32 mm
	920/21	125 mm
	920/22	255 mm
	920/25	
	920/42	
	920/58	
		420x185x60 mm - 5,1 kg

## 928B

chaves de caixa boca de 12 faces

3/4"



UNI/ISO 2725  
DIN 3124

mm	Ø mm	L mm	Ø1 mm	€	5	10
19	29,2	50	34	18,60	5	009280119
21	30,0	51	34	18,90	5	009280121
22	31,3	53	34	18,90	5	009280122
23	33,3	53	34	19,20	5	009280123
24	34,5	53	34	19,60	5	009280124
26	36,8	55	35	21,00	5	009280126
27	38,0	56	35	21,00	5	009280127
28	39,0	57	35	22,20	3	009280128
29	40,2	58	35	22,60	3	009280129
30	41,5	58	37	23,30	3	009280130
32	44,3	60	37	24,50	3	009280132
33	45,8	60	37	26,00	3	009280133
34	46,8	60	37	26,00	3	009280134
35	48,1	62	38	26,50	3	009280135
36	49,5	64	38	26,50	3	009280136
38	52,0	68	40	29,00	3	009280138
41	56,0	71	40	32,00	3	009280141
46	62,3	75	43	40,00	3	009280146
50	67,4	80	43	47,50	3	009280150
55	73,7	84	48	58,50	1	009280155
60	80,0	87	48	68,00	1	009280160

## 928AS

chaves de caixa boca hexagonal



"	Ø mm	L mm	Ø1 mm	€		
7/8	32,0	53	34	21,00	1	009280202
15/16	34,5	53	34	21,00	1	009280203
1	36,2	55	35	22,20	1	009280204
1.1/16	38,0	56	35	22,90	1	009280205
1.1/8	40,2	58	35	23,50	1	009280206
1.1/4	44,2	60	37	25,50	1	009280208
1.5/16	45,8	60	37	26,50	1	009280209
1.3/8	48,1	62	38	28,00	1	009280210
1.7/16	49,5	64	38	29,00	1	009280211
1.1/2	52,0	68	40	31,50	1	009280212
1.5/8	56,0	71	40	34,50	1	009280214
1.11/16	58,8	74	40	39,50	1	009280215
1.13/16	62,3	75	43	44,00	1	009280217
1.7/8	65,0	78	43	47,50	1	009280218
2	68,3	80	43	54,50	1	009280219
2.1/16	71,5	83	48	63,50	1	009280220

## 928ME

chave de caixa com ponta macho hexagonal

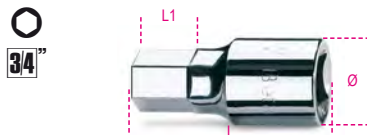

mm	Ø mm	L mm	L1 mm	€		
14	35	75	15,5	42,50	2	009280514
17	35	75	15,5	42,50	2	009280517
19	35	75	15,5	42,50	2	009280519
22	35	75	22,5	42,50	2	009280522

## 928/15

redução quadra fêmea de 3/4"  
para quadra macho de 1/2"



UNI/ISO 3316  
DIN 3123

L mm	Ø mm	□ 3/4	■ 1/2	€		
51,5	34	3/4	1/2	22,20	5	009280801



Aplique sempre uma força de aperto regular e progressiva, a fim de evitar a ruptura do material e de se proteger de um possível acidente



## 928/16

adaptador quadra fêmea de 3/4"  
para quadra macho de 1"



UNI/ISO 3316  
DIN 3123

L mm	Ø mm	□ 3/4	■ 1"	€		
65	34	3/4	1"	26,50	5	009280807

## 928/20 - 928/21 - 928/22

extensões com quadras macho  
e fêmea de 3/4"



UNI/ISO 3316  
DIN 3123

	L mm	Ø mm	€		
928/20	100	34	26,00	3	009280810
928/21	200	34	35,00	3	009280815
928/22	380	34	51,50	3	009280825

## 928/25

cardan com quadras macho e fêmea 3/4"



UNI/ISO 3316 DIN 3123

L mm	Ø mm	€		
108	40	88,00	1	009280830

## 928/36A

cabo articulado, quadra de 3/4"  
com punho



DIN 3122 - UNI ISO 3315

L mm	€		
545	106,00	1	009280844

## 928/42

cabo T correção, quadra de 3/4"

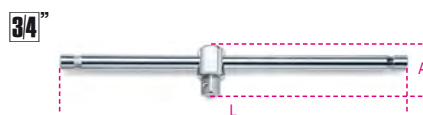

UNI/ISO 3315 DIN 3122

L mm	A mm	€		
450	62,5	56,00	3	009280850

## 928/55

roquete reversível quadra macho de 3/4",  
mecanismo de 72 dentes



DIN 3122 - UNI ISO 3315

L mm	Ø mm	A mm	€		
504	58	59	181,00	2	009281155

Mecanismos rotativos de substituição para  
roquetes

111



Beta



## 928.../C12

jogo de 12 chaves de caixa hexagonal e 5 acessórios em caixa metálica



928A/C12 € 955,00 1 009280955

	928A	22 - 24 - 27 - 30 - 32 - 34 - 36 38 - 41 - 46 - 50 - 55 mm
	928/21	200 mm
	928/22	380 mm
	928/25	
	928/42	
	928/55	

530x220x80 mm - 13,5 kg

928B/C12 € 955,00 1 009280957

	928B	22 - 24 - 27 - 30 - 32 - 34 - 36 38 - 41 - 46 - 50 - 55 mm
	928/21	200 mm
	928/22	380 mm
	928/25	
	928/42	
	928/55	

530x220x80 mm - 13,5 kg

## 928AS/C12

jogo de 12 chaves de caixa hexagonal e 6 acessórios em caixa metálica



928AS/C12 € 985,00 1 009280968

	928AS	7/8-15/16-1.1/16-1.1/8-1.1/4 1.5/16-1.7/16-1.1/2-1.11/16 1.13/16-1.7/8-2.1/16
	928/21	200 mm
	928/22	380 mm
	928/25	
	928/42	
	928/55	

530x220x80 mm - 13,5 kg

## 929

chaves de caixa com boca hexagonal



UNI/ISO 2725 DIN 3124

mm	Ø mm	L mm	Ø1 mm	€		
36	51	65	48	38,50	1	009290036
41	57	70	48	41,00	1	009290041
46	65	75	48	46,00	1	009290046
50	70	80	48	53,00	1	009290050
55	76	85	54	62,50	1	009290055
60	82	90	54	66,50	1	009290060
65	88	95	54	86,00	1	009290065
70	92	100	60	103,00	1	009290070
75	99	110	60	112,00	1	009290075
80	106	120	60	128,00	1	009290080

## 929/15

redução quadra fêmea de 1" para quadra macho de 3/4"

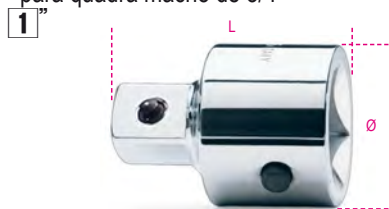

UNI/ISO 3316 DIN 3123

L mm	Ø mm	□	■	€		
65	47	1"	3/4"	46,00	2	009290801



Aplique sempre uma força de aperto regular e progressiva, a fim de evitar a ruptura do material e de se proteger de um possível acidente

## 929/21 - 929/22

extensões com quadras macho e fêmea de 1"



UNI/ISO 3316 DIN 3123

	L mm	Ø mm	€		
929/21	200	47	59,00	1	009290815
929/22	400	47	86,00	1	009290825

## 929/42

cabo T corrediço, quadra de 1"



UNI/ISO 3315 DIN 3122

L mm	€		
535	111,00	1	009290850

## 929/55

roquete reversível, quadra de 1" 72 dentes



UNI/ISO 3315 DIN 3122

L mm	Ø mm	A mm	€		
770	62	63	238,00	1	009290860

## 929/55PR

extensão para roquete 929/55



L mm	Ø mm	Ø1 mm	€		
540	32	26	51,00	1	009290868

## 929/C8

jogo com 8 chaves de caixa e 5 acessórios



929/C8 € 1.390,00 1 009290925

	929	46 - 50 - 55 - 60 - 65 70 - 75 - 80 mm
	929/15	□ 1" - ■ 3/4"
	929/21	200 mm
	929/22	400 mm
	929/42	
	929/55	

560x290x120 mm - 29 kg





### 9899 CV/A

estojo, vazio



**9899 CV/A** € 37,50 1 098990001

583/C31-671B/C5-671B/C10-720ME/C8  
860/C38P-861/C61P-900/C11-900AS/C10-/MB-C17  
900/C24-900/C13-8-900/C13-5-900MB/C19-900MB/C28  
900/C11HR-900AS/C10-/MB-C17-900AS/C17-MBM  
900/C11Z-900MC/C24-900MC/C32-910.../C10  
971/C8-920TX/C-920PE/C-920FTX/C-910.../C10

≡ 270x120x45 mm

### 9899 CV/B

estojo, vazio



**9899 CV/B** € 43,50 1 098990002

352C/U-720MC/C13-727/C16-867/C20-900/C12MR  
900/C12MZ-900U/C12M-910AS/C13...-910AS/MBM-C18  
910A/C16...-910B/C16...-910A/C16HR  
910A/C16...-910B/C16...-920AS/C10-920.../C11-1433/C11  
1494/C14A-1529-1545/C5M

≡ 335x145x60 mm

### 9899 CV/C

estojo, vazio



**9899 CV/C** € 53,50 1 098990003

920A/C17HR-920A/C17MR-920.../C12...  
920A/C17M-910.../C29-902A/C22-867/C38  
720/C24-450/C15-353N/C6-960KPC-920MC/C14  
920U/C17M-920TX/C17-920.../C20...  
920AS/MBM-C21-920AS/C17X-1547/C6-1495/C6  
1489/C14-1461/C11A-1608/C9-1606A/C9-1602/C9

≡ 420x185x60 mm

### 900/R55



**900/R55** € 38,50 1 009000871

666N/2-666/2-666LBF.FT/2

### 900/RN55



**900/RN55** € 38,50 1 009001115

900/55

### 900/R55-Z



**900/R55-Z** € 38,50 1 009000872

### 900M/R55



**900M/R55** € 20,30 1 009000888

900M/55

### 910/R55



**910/R55** € 37,50 1 009100879

599DGT/6-606/6-606/10-612-665/6-665/10-665LB/6  
665LB/10-666N/5-666N/10-666N LBF.IN/5-666NLBF.IN/10  
666/6-666/10-668RGC/6-668RGC/10-666/5  
666HS/5-666HS/10-666 LBF.FT/5-666 LBF.FT/10

### 910/RN55



**910/RN55** € 37,50 1 009101115

910/55

### 910M/R55



**910M/R55** € 21,00 1 009100888

910M/55-910M/56

### 910/R55X



**910/R55X** € 37,50 1 009100897

666N/2X-666/2X-666 LBF.FT/2X

### 920/R50



**920/R50** € 30,50 1 009200866

614/50-667/20-667/30  
667N/20-667N/30

### 920/RN50



**920/RN50** € 30,50 1 009201130

920/50

### 920/RN50F



**920/RN50F** € 30,50 1 009201131

920/50F

### 920/R55



**920/R55** € 37,50 1 009200879

606/20-606/30-666/20-666/30-920/56A- 599DGT/20-  
599DGT/30  
599DGT-AN/20-665/20-665/30-665LB/20  
665LB/30-666N/20-666N/30  
666N LBF.IN/20-666N LBF.IN/30-668RGC/20  
666 LBF.FT/20-666 LBF.FT/30

## 920/RN55



920/RN55 37,50 € 1 009201125  
920/55

## 920M/R55



920M/R55 19,40 € 1 009200888  
920M/55-920M/56

## 920/RN55Q



920/RN55Q 37,50 € 1 009201126  
920/55Q

## 920/R55X



920/R55X 30,50 € 1 009200878  
606/10X-612X  
666/10X-599DGT/10X-599DGT-AN/10  
665/10X-665LB/10X-666N 10X-666N LBF.IN/10X  
668RGC/10X-666 LBF.FT/10X  
666HS/20LC-666HS/30LC

## 920/RN55X



920/RN55X 30,50 € 1 009201128  
920/55X

## 920/R55LC



920/R55LC 39,00 € 1 009200887  
666HS/20LC-666HS/30LC

## 920/RN55LC



920/RN55LC 39,00 € 1 009201129  
920/55LC "Locking System"

## 928/RN55



928/RN55 75,50 € 1 009281115  
928/55

## 928/R55X



928/R55X 48,00 € 1 009280858  
614X

## 929/R55



929/R55 87,00 € 1 009290859  
929/55

## 930

chaves tubulares de 12 faces,  
serviço pesado



UNI 6745

Ø mm	L mm	Ø mm	Ø1 mm	€	1	009300006
6x7	100	9,5	11,0	15,20	3	009300006
8x9	108	12,5	14,0	19,10	3	009300010
10x11	116	15,0	16,5	20,00	3	009300014
12x13	124	17,5	19,0	23,50	3	009300018
14x15	132	20,0	21,5	25,50	3	009300023
16x17	140	23,0	24,0	29,50	3	009300027
18x19	148	25,0	26,5	32,50	3	009300032
20x22	156	28,0	30,0	36,00	2	009300036
21x23	163	29,0	31,5	38,00	2	009300040
24x26	173	33,0	35,5	48,50	2	009300044
25x28	182	34,5	38,0	52,50	2	009300048
27x29	191	37,0	39,5	60,00	2	009300052
30x32	200	40,5	43,0	72,50	2	009300056



930/S8 217,00 € 1 009300081  
6x7-8x9-10x11-12x13-14x15  
16x17-18x19-20x22 mm

940/1 - /2 505,00 1 009300083  
930/S13  
6x7-8x9-10x11-12x13-14x15-16x17  
18x19-20x22-21x23-24x26  
25x28-27x29-30x32 mm

940/1 - /2 - /3



930/C13 580,00 € 1 009300098  
6x7-8x9-10x11-12x13  
14x15-16x17-18x19  
20x22-21x23-24x26  
25x28-27x29-30x32 mm

940/1 - /2 - /3

## 932

chaves de cachimbo 6 faces/12 faces  
em cromado brilhante

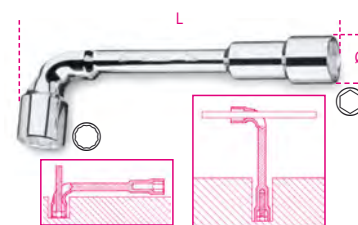

NF E 74.303

Ø mm	Ø mm	L mm	€	5	009320006
6x6	11,5	110	17,10	5	009320006
7x7	12,5	116	17,30	5	009320007
8x8	13,0	120	17,90	5	009320008
9x9	14,0	125	18,60	5	009320009
10x10	16,5	133	19,30	5	009320010
11x11	17,5	143	21,10	5	009320011
12x12	19,0	148	22,40	5	009320012
13x13	19,5	154	23,40	5	009320013
14x14	21,5	167	24,70	5	009320014
15x15	22,5	182	26,00	5	009320015
16x16	24,5	193	27,00	5	009320016
17x17	26,0	198	27,50	5	009320017
18x18	26,5	215	30,00	5	009320018
19x19	29,0	220	32,50	5	009320019
20x20	30,5	222	35,00	3	009320020
21x21	30,5	236	40,00	3	009320021
22x22	32,5	250	43,50	2	009320022
23x23	33,5	256	48,50	2	009320023
24x24	35,0	272	52,00	2	009320024
25x25	36,5	282	55,50	2	009320025
26x26	37,5	296	60,50	2	009320026
27x27	39,0	296	63,50	2	009320027
28x28	39,0	314	72,00	2	009320028
30x30	42,5	348	86,50	2	009320030
32x32	45,5	364	95,50	2	009320032



<b>932/S11</b>	€ 267,00	1	009320080
6-7-8-10-11-12 13-14-17-19-22 mm			
<b>932/S17</b>	€ 443,00	1	009320081
6-7-8-9-10-11-12 13-14-15 16-17-18-19-20-21-22 mm			
<b>932/S25</b>	€ 975,00	1	009320082
6-7-8-9-10-11-12-13 -14-15-16-17-18-19 20-21-22-23-24-25 -26-27-28-30-32 mm			

### 933

chaves de cachimbo hexagonal em cromado brilhante

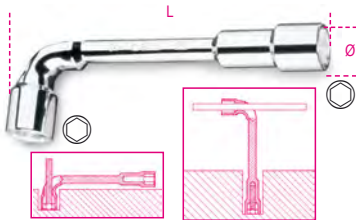

NF E 74.303

mm	Ø mm	L mm	€		
6x6	11,5	110	17,10	5	009330006
7x7	12,5	116	17,30	5	009330007
8x8	13,0	120	17,90	5	009330008
9x9	14,0	125	18,60	5	009330009
10x10	16,5	133	19,30	5	009330010
11x11	17,5	143	21,10	5	009330011
12x12	19,0	148	22,40	5	009330012
13x13	19,5	154	23,40	5	009330013
14x14	21,5	167	24,70	5	009330014
15x15	22,5	182	26,00	5	009330015
16x16	24,5	193	27,00	5	009330016
17x17	26,0	198	27,50	5	009330017
18x18	26,5	215	30,00	5	009330018
19x19	29,0	220	32,50	5	009330019
20x20	30,5	222	35,00	3	009330020
21x21	30,5	236	40,00	3	009330021
22x22	32,5	250	43,50	2	009330022
23x23	33,5	256	48,50	2	009330023
24x24	35,0	272	52,00	2	009330024
25x25	36,5	282	55,50	2	009330025
26x26	37,5	296	60,50	2	009330026
27x27	39,0	296	63,50	2	009330027
28x28	39,0	314	72,00	2	009330028
30x30	42,5	348	86,50	2	009330030
32x32	45,5	364	95,50	2	009330032



<b>933/S11</b>	€ 267,00	1	009330080
6-7-8-10-11-12-13-14-17-19-22 mm			
<b>933/S17</b>	€ 443,00	1	009330081
6-7-8-9-10-11-12-13-14-15-16-17 18-19-20-21-22 mm			
<b>933/S25</b>	€ 975,00	1	009330082
6-7-8-9-10-11-12-13-14-15-16-17-18-19 20-21-22-23-24-25-26-27-28-30-32 mm			

### 935

chaves tubulares hexagonais, série ligeira



UNI 6746 DIN 896

mm	L mm	€		
6x7	100	8,80	5	009350105
8x9	110	9,50	5	009350111
10x11	120	10,60	5	009350115
12x13	130	11,90	5	009350117
14x15	140	13,90	5	009350126
16x17	150	15,20	5	009350128
18x19	160	17,90	5	009350131
20x22	170	21,70	3	009350138
21x23	180	24,10	3	009350141
24x26	190	27,50	3	009350144
25x28	200	30,00	2	009350150
27x29	210	35,50	2	009350153
30x32	220	38,00	2	009350156



<b>935/S8</b>	€ 125,00	1	009350181
6x7-8x9-10x11-12x13-14x15-16x17 18x19-20x22 mm			
<b>940/1 - /2</b>			
<b>935/S13</b>	€ 295,00	1	009350183
6x7-8x9-10x11-12x13-14x15-16x17 18x19-20x22-21x23-24x26-25x28 27x29-30x32 mm			
<b>940/1 - /2 - /3</b>			

### 937

chaves de cachimbo 6 faces/12 faces cromadas

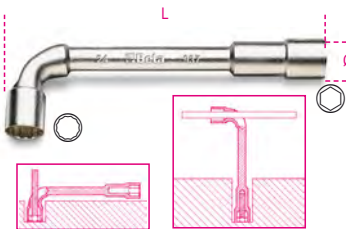

mm	Ø mm	L mm	€		
6x6	11,5	110	9,50	5	009370006
7x7	12,5	116	9,90	5	009370007
8x8	13,0	120	10,20	5	009370008
9x9	14,0	125	10,90	5	009370009
10x10	16,5	133	11,40	5	009370010
11x11	17,5	143	11,90	5	009370011
12x12	19,0	148	13,30	5	009370012
13x13	19,5	154	13,70	5	009370013
14x14	21,5	167	15,00	5	009370014
15x15	22,5	182	16,50	5	009370015
16x16	24,5	193	17,80	5	009370016
17x17	26,0	198	18,50	5	009370017
18x18	26,5	215	18,90	5	009370018
19x19	29,0	220	19,70	5	009370019
20x20	30,5	222	22,30	3	009370020
21x21	30,5	236	24,40	3	009370021
22x22	32,5	250	25,50	2	009370022
23x23	33,5	256	28,50	2	009370023
24x24	35,0	272	29,50	2	009370024
25x25	36,5	282	37,50	2	009370025
26x26	37,5	296	38,50	2	009370026
27x27	39,0	296	39,50	2	009370027
28x28	39,0	314	47,50	2	009370028
30x30	42,5	348	51,00	2	009370030
32x32	45,5	364	57,50	2	009370032



<b>937/S11</b>	€ 159,00	1	009370080
6-7-8-10-11-12 -13-14-17-19-22 mm			
<b>937/S17</b>	€ 269,00	1	009370081
6-7-8-9-10-11-12 -13-14-15-16-17 18-19-20-21-22 mm			

### 940

passadores para chaves tubulares ref. 930 e 935



	mm	L mm	€		
<b>940/1</b>	6÷13	100	6,60	5	009400001
<b>940/2</b>	14÷22	170	8,60	5	009400002
<b>940/3</b>	21÷32	290	15,50	5	009400003

### 941

chave de caixa sextavada/bisextavada, com punho de binário elevado

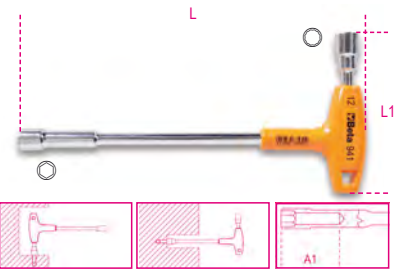

mm	L mm	L1 mm	A1 mm	€		
7x7	200	91	35	31,50	2	009410107
8x8	220	107	50	35,00	2	009410108
9x9	220	109	50	35,00	2	009410109
10x10	236	111	50	35,50	2	009410110
11x11	236	114	50	37,00	2	009410111
12x12	255	122	50	41,00	2	009410112
13x13	255	124	55	41,50	2	009410113



<b>941/S7</b>	€ 257,00	1	009410170
7-8-9-10-11-12-13 mm			





# CHAVES DE CAIXA com punho

Adequadas para operações de aperto rápidas e repetitivas. A sua espessura reduzida permite aceder a espaços reduzidos.

O furo de exaustão interior facilita o trabalho em porcas com roscas projetadas. É o caso das chaves de caixa profundas 944BX.

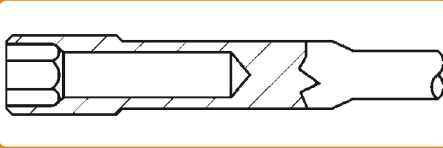

A marcação tripla na cabeça facilita a identificação do tamanho pretendido.

O veio flexível do modelo 943FL, com núcleo em aço e revestimento de proteção, permite a transmissão da força em caso de desalinhamento com o parafuso.

## 942BX

chave de caixa com punho sextavada de binário elevado modelo curto



UNI 6750

Ø mm	L mm	L1 mm	A1 mm	€	📦	📄
4	190	70	13,0	15,90	5	009420003
5	190	70	14,0	15,90	5	009420004
5,5	190	70	12,5	17,90	5	009420005
6	190	70	14,5	17,90	5	009420006
7	190	70	15,5	18,80	5	009420007
8	202	70	18,5	18,80	5	009420008
9	202	70	19,5	18,80	5	009420009
10	202	70	20,5	20,00	3	009420010
11	202	70	21,5	20,00	3	009420011
12	202	70	22,5	20,00	3	009420012
13	202	70	23,5	22,60	3	009420013
14	202	70	24,5	22,60	3	009420014



**942BX/S12** € 229,00 📦 1 📄 009420030  
4-5-5,5-6-7-8-9  
10-11-12-13-14 mm

## 943BX

chave de caixa com punho sextavada de binário elevado modelo longo



ISO 2236 UNI 6750

Ø mm	L mm	L1 mm	A1 mm	€	📦	📄
4	270	150	13,0	17,60	5	009430003
5	270	150	14,0	17,60	5	009430004
5,5	270	150	12,5	18,90	5	009430005
6	270	150	14,5	18,90	5	009430006
7	270	150	15,5	20,20	5	009430007
8	282	150	18,5	20,20	5	009430008
9	282	150	19,5	20,20	5	009430009
10	282	150	20,5	22,10	3	009430010
11	282	150	21,5	22,10	3	009430011
12	282	150	22,5	22,10	3	009430012
13	282	150	23,5	23,50	3	009430013
14	282	150	24,5	23,50	3	009430014



**943BX/S12** € 247,00 📦 1 📄 009430030  
4-5-5,5-6-7-8-9  
10-11-12-13-14 mm



**943BX/D6** € 123,00 📦 1 📄 009430026  
5-6-7-8-10-13 mm

## 943FL

chaves de caixa hexagonal flexível com punho



Ø mm	L mm	L1 mm	Ø mm	€	📦	📄
5	265	150	8	24,80	2	009430304
5,5	265	150	8	24,80	2	009430305
6	265	150	9	24,80	2	009430306
7	265	150	11	24,80	2	009430307
8	265	150	12	25,50	2	009430308
10	290	175	14	28,00	2	009430310



**943FL/S6** € 153,00 📦 1 📄 009430320  
5-5,5-6-7-8-10 mm

## 944BX

chave de caixa com punho sextavada profunda de binário elevado modelo longo



ISO 2236 UNI 6750

Ø mm	L mm	L1 mm	A1 mm	€	📦	📄
4	245	125	20	18,30	3	009440003
5	245	125	25	18,30	3	009440004
5,5	245	125	30	22,30	3	009440005
6	245	125	35	22,30	3	009440006
7	245	125	35	22,30	3	009440007
8	257	125	50	24,00	3	009440008
9	257	125	50	24,00	3	009440009
10	257	125	50	25,00	3	009440010
11	257	125	50	25,00	3	009440011
12	257	125	50	27,50	3	009440012
13	257	125	55	27,50	3	009440013
14	257	125	55	27,50	3	009440014



**944BX/S12** € 283,00 📦 1 📄 009440062  
4-5-5,5-6-7-8-9  
10-11-12-13-14 mm



**944BX/D6** € 139,00 📦 1 📄 009440056  
5-6-7-8-10-13 mm

## 949

chaves de caixa com punho em T

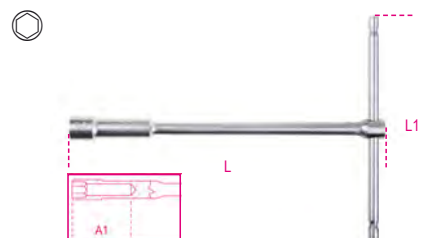

Ø mm	L mm	L1 mm	€	📦	📄
8	220	160	33,50	2	009490008
10	230	160	35,00	2	009490010
12	240	175	36,00	2	009490012
13	244	175	37,00	2	009490013
14	250	190	39,50	2	009490014
17	264	200	45,50	2	009490017



<b>949/S6</b>	€ 226,00	1	009490076
8-10-12-13-14-17mm			

## 950

chaves de caixa simples hexagonal com punho em T

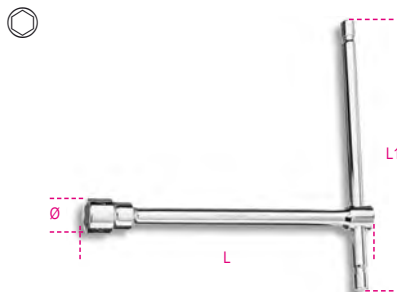

UNI 6742 DIN 3112

mm	L mm	Ø mm	L1 mm	€		
6	210	10,1	145	23,00	3	009500006
7	212	11,2	145	23,00	3	009500007
8	220	12,4	160	24,80	3	009500008
9	223	13,5	160	24,80	3	009500009
10	230	14,9	160	27,00	3	009500010
11	233	16,1	160	27,00	3	009500011
12	240	17,5	175	29,50	3	009500012
13	244	19,7	175	29,50	3	009500013
14	250	20,1	190	33,50	3	009500014
15	254	21,5	190	35,00	3	009500015
16	260	22,7	200	38,00	3	009500016
17	264	24,1	200	39,50	3	009500017
19	274	26,6	230	48,50	3	009500019
22	290	29,9	290	58,50	2	009500022
24	300	32,2	320	66,00	2	009500024
27	315	36,2	370	78,00	2	009500027



<b>950/S9</b>	€ 282,00	1	009500079
7-8-10-11-12 13-14-17-19 mm			
<b>950/S14</b>	€ 460,00	1	009500082
6-7-8-9-10-11-12-13 14-15-16-17-19-22 mm			

# 951 CHAVES COM PUNHO EM T E TRÊS MACHOS SEXTAVADOS



Quando a Beta lançou esta chave, em 1980, foi uma revolução. Concebida para parafusos de alta resistência, é sinónimo de manuseamento rápido, encaixe preciso e utilização versátil. Regulação livre do punho sextavado em T. Extremidades sextavadas desenhadas para transmissão da máxima força possível ao parafuso.

A sua extensão permite a aplicação de apertos extraordinários aos parafusos. Constantes melhorias na produção traduziram-se, por exemplo, em acabamentos com jato de areia e extremidades sextavadas de arestas afiadas que garantem um melhor encaixe em quaisquer parafusos, mesmo nos danificados. A marcação a laser resulta num punho mais resistente. A marcação a laser torna a haste mais resistente.

O novo modelo, 951GP, foi desenvolvido em conjunto com técnicos e mecânicos de MotoGP e Superbike, com o objetivo de aumentar a velocidade de aparafusar/desaparafusar.

## 951

chaves em T com macho hexagonal articulado



mm	L mm	L1 mm	Ø mm	€		
2	125	63	4,0	21,10	5	009510521
2,5	150	63	4,0	21,10	5	009510525
3	150	63	4,0	21,10	5	009510530
3,5	175	76	5,5	21,70	5	009510535
4	175	76	5,5	21,70	5	009510540
4,5	195	87	6,5	23,80	5	009510545
5	195	87	6,5	23,80	5	009510550
6	215	99	8,0	27,50	5	009510560
7	230	109	9,0	29,50	5	009510570
8	250	122	10,0	29,50	5	009510580
9	265	132	11,0	37,00	5	009510590
10	280	142	12,0	37,00	5	009510610
12	305	160	15,0	50,50	3	009510620
14	330	178	17,0	60,00	3	009510640

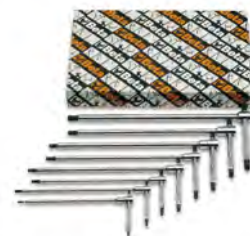

<b>951/S6</b>	€ 145,00	1	009510687
2,5-3-4-5-6-8 mm			
<b>951/S8</b>	€ 182,00	1	009510693
2-2,5-3-3,5-4-4,5-5-6 mm			
<b>951/S14</b>	€ 425,00	1	009510695
2-2,5-3-3,5-4-4,5 5-6-7-8-9-10-12-14 mm			



<b>951/SP6</b>	€ 185,00	1	009510696
3-4-5-6-8-10 mm			
<b>951/SPV</b>	€ 34,00	1	009510697



## 951AS

chaves em T com macho hexagonal, articulado

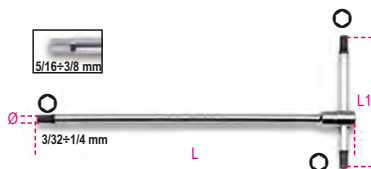

"	L mm	L1 mm	Ø mm	€	🔧	📦
3/32	125	63	4,0	28,50	2	009510750
7/64	150	63	4,0	28,50	2	009510751
1/8	150	63	4,0	28,50	2	009510752
9/64	175	76	5,5	29,50	2	009510753
5/32	175	76	5,5	29,50	2	009510754
3/16	195	86	6,5	32,00	2	009510755
7/32	215	99	8,0	32,00	2	009510757
1/4	230	109	9,0	36,50	2	009510758
5/16	250	122	10,0	37,00	2	009510759
3/8	280	142	12,0	45,50	2	009510760

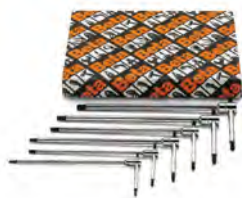

951AS/S6X 212,00 € 1 009510771  
1/8-3/16-7/32-1/4-5/16-3/8

## 951GP

chave em T com macho sextavado

A chave Beta 951GP é sinónimo de um ajuste rápido e preciso.

Concebida para satisfazer alguns requisitos importantes do mundo das corridas: desenvolver valores de binário elevados e garantir um aperto rápido.

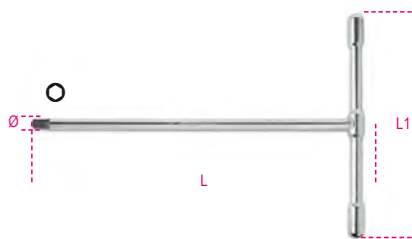

mm	L mm	L1 mm	Ø mm	€	🔧	📦
3	185	130	5	20,80	3	009511530
4	214	150	5	21,80	3	009511540
5	240	165	6	25,00	3	009511550
6	271	180	7	29,00	3	009511560
8	300	200	10	37,00	3	009511580
10	310	200	12	46,00	3	009511610



951GP/S6 180,00 € 1 009511687  
3-4-5-6-8-10 mm

## 951TX

chaves em T com pontas para parafusos de perfil Torx®, articulado

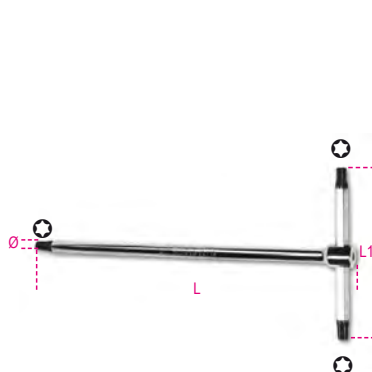

🔧	L mm	L1 mm	Ø mm	€	🔧	📦
T6	125	63	4	26,00	3	009510806
T7	125	63	4	26,00	3	009510807
T8	125	63	4	27,00	3	009510808
T9	125	63	4	27,00	3	009510809
T10	150	63	4	27,50	3	009510810
T15	150	63	4	27,50	3	009510815
T20	175	76	5	29,00	3	009510820
T25	175	76	5	29,00	3	009510825
T27	195	87	6	30,50	3	009510827
T30	195	87	6	30,50	3	009510830
T40	215	99	7	35,50	3	009510840
T45	230	109	8	37,50	3	009510845
T50	250	122	9	40,50	3	009510850

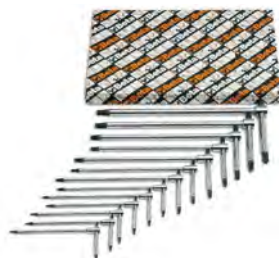

951TX/S6 170,00 € 1 009510866  
T8-T10-T15-T20-T25-T30  
951TX/S13 393,00 € 1 009510863  
T6-T7-T8-T9-T10-T15-T20-T25  
T27-T30-T40-T45-T50



## 952 CHAVES DE CAIXA COM CARDAN E CABO EM T EM T

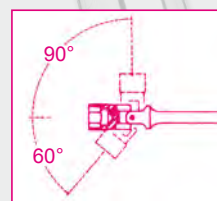

O segredo do sucesso desta chave é o pré-posicionamento preciso e fiável.

A junta articulada mantém a sua função ao longo dos anos, sem necessidade de ajustes. Ângulo de rotação: 60°.

Possibilidade de utilização a 90° em posição fixa. Cabo em T deslizante, com possibilidade de bloqueio em qualquer posição ao longo de toda a extensão.

Marcação de três tamanhos na cabeça.



## 952

chaves de caixa hexagonais com cardam e cabo em T

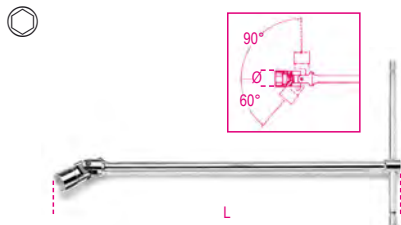

UNI 6743

mm	Ø mm	L mm	€		
6	9,5	395	35,50	5	009520006
7	10,7	395	35,50	5	009520007
8	12,1	395	35,50	5	009520008
9	13,2	395	35,50	5	009520009
10	14,6	400	38,00	5	009520010
11	15,8	400	38,00	5	009520011
12	17,0	400	38,00	5	009520012
13	18,7	432	41,00	5	009520013
14	19,7	432	41,00	5	009520014
15	20,9	450	50,50	3	009520015
16	22,0	450	50,50	3	009520016
17	23,4	450	50,50	3	009520017
18	24,7	450	50,50	3	009520018
19	26,0	500	61,50	3	009520019
20	27,4	500	61,50	3	009520020
21	28,5	500	61,50	3	009520021
22	29,7	500	61,50	3	009520022
24	32,4	500	61,50	3	009520024



<b>952/S7</b> 8-10-11-13-14-17-19 mm	<b>305,00</b>	1	009520074
<b>952/S10</b> 7-8-10-11-12-13-14-15-17-19 mm	<b>429,00</b>	1	009520080
<b>952/S18</b> 6-7-8-9-10-11-12-13-14-15-16-17-18-19-20-21-22-24 mm	<b>845,00</b>	1	009520083



<b>952/D7</b> 7-8-10-12-13-14-17 mm	<b>280,00</b>	1	009520079
--	---------------	---	-----------

## 852



852 1/4

79,85

## 952AS

chaves de caixa hexagonais com cardan e cabo em T

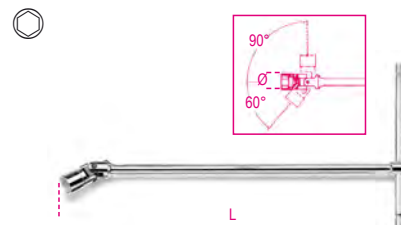

"	Ø mm	L mm	€		
1/4	9,5	395	38,50	2	009520256
5/16	12,1	395	38,50	2	009520258
3/8	14,6	400	41,50	2	009520260
7/16	15,8	400	41,50	2	009520261
1/2	18,7	432	47,00	2	009520263
9/16	19,7	432	50,50	2	009520264
5/8	22,0	450	53,50	2	009520266
11/16	23,4	450	53,50	2	009520267
3/4	26,0	500	66,50	2	009520269

## 952L

chaves de caixa hexagonais com cardan e cabo em T série longa

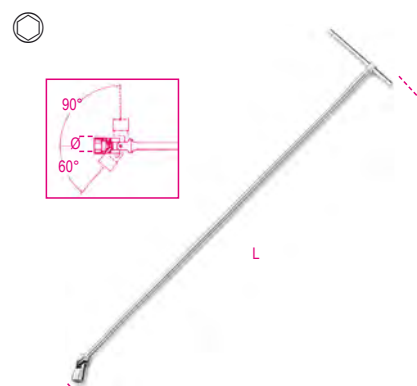

mm	Ø mm	L mm	€		
10	14,6	930	97,50	1	009520410
12	17,0	1063	97,50	1	009520412
13	18,7	1100	97,50	1	009520413
14	19,7	1100	97,50	1	009520414
15	20,9	1100	109,00	1	009520415
16	22,0	1100	109,00	1	009520416
17	23,4	1100	109,00	1	009520417
18	24,7	1100	109,00	1	009520418
19	26,0	1100	127,00	1	009520419

## 952FTX

chaves de caixa com cardan e cabo em T, para parafusos com perfil Torx®

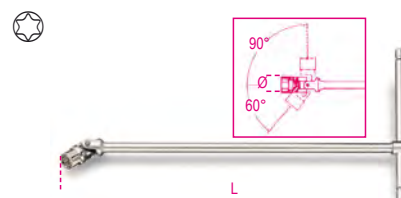

Ø mm	L mm	€		
E6	8	392	41,50	2 009520106
E7	9	392	41,50	2 009520107
E8	10	395	48,00	2 009520108
E10	13	400	49,00	2 009520110
E12	15	440	59,00	2 009520112
E14	17	490	72,00	2 009520114
E16	19	490	72,00	2 009520116
E18	21	490	72,00	2 009520118
E20	23	490	72,00	2 009520120



<b>952FTX/S9</b> E6-E7-E8-E10-E12 E14-E16-E18-E20	<b>530,00</b>	1	009520141
---	---------------	---	-----------

## 953

chaves em T com macho hexagonal articulado

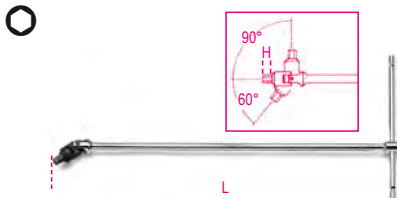

UNI 6754

mm	H mm	L mm	€		
3	5	395	36,50	5	009530130
3,5	6	395	36,50	3	009530135
4	6	395	36,50	5	009530140
4,5	7	395	36,50	3	009530145
5	7	395	36,50	5	009530150
6	9	400	39,50	5	009530160
7	10	425	43,50	3	009530170
8	11	425	43,50	5	009530180
10	13	440	52,00	5	009530200



<b>953/S5</b> 3-4-5-6-8 mm	<b>193,00</b>	1	009530305
<b>953/S9</b> 3-3,5-4-4,5 5-6-7-8-10 mm	<b>361,00</b>	1	009530301

## 953TX

chaves em T com macho de perfil Torx® articulado

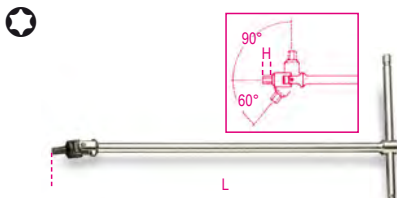

Ø mm	H mm	L mm	€		
T20	11	396	44,50	2	009530020
T25	11	396	44,50	2	009530025
T27	11	396	44,50	2	009530027
T30	13	400	49,00	2	009530030
T40	13	400	49,00	2	009530040
T45	13	426	50,50	2	009530045
T50	14	442	59,00	2	009530050
T55	14	442	59,50	2	009530055



<b>953TX/S8</b> T20-T25-T27-T30 T40-T45-T50-T55	<b>401,00</b>	1	009530060
---	---------------	---	-----------



# REPARAÇÃO DE VEÍCULOS

As nossas ferramentas para reparação de veículos, usadas pelos profissionais mais exigentes, são desenvolvidas e fabricadas para cumprir as normas mais rígidas a nível mundial, e são testadas com regularidade sob as mais difíceis condições de trabalho.

Há mais de 50 anos que temos o orgulho de trabalhar de mãos dadas com os melhores, que nos ajudam a melhorar continuamente os nossos produtos e são testemunhas dos mais elevados padrões de qualidade.

## As ferramentas de reparação de veículos encontram-se nas seguintes secções:

### Diagnóstico

itens 1464T/N a 1465  
itens 1498SM a 1499  
itens 1758VT a 1760/IR 1600

### Motor

itens 955 a 960SN  
itens 1440 a 1462/KEP  
itens 1472 a 1485TC  
itens 1737 a 1759TT

### Óleo e filtros

itens 1488/1 a 1496/C  
itens 1877 a 1889N

### Sistema elétrico

itens 1489/33 a 1489Y  
itens 1497D a 1497RC

### Arrancadores

itens 1498BC/12 a 1498DG1100E

### Transmissão

itens 1884 a 1885/X C60  
itens 1438 a 1438DSG  
itens 1566N a 1569/F

### Suspensão

itens 1550U a 1567

### Travões

itens 1466/C5 a 1471T/C5

### Rodas

itens 720MRC a 729T  
itens 962 a 989B  
itens 1530/C5 a 1531/C7

### Carroçaria

itens 1065F5 a 1068  
itens 1302 a 1369/C11  
itens 1478 a 1479U/32  
itens 1505V a 1539  
itens 1763 a 1768

### Outros equipamentos

itens 1875LT a 3067

### Elevação

itens 3006 a 3069

## 955

chave tubular para velas



mm - "	D mm	L mm	€	3	009550016
16	21	86	18,10		
5/8					

## 956C

chaves de caixa para velas quadra fêmea de 1/2"



ISO 11168

mm - "	D mm	L mm	€	3	009560008
14	18,8	70	34,00		
9/16					
16	21,4	70	34,00		3 009560010
5/8					
17,8	23,6	70	34,00		3 009560011
11/16					
20,8	27,0	70	34,00		3 009560012
13/16					

## 956E

chaves de caixa para velas quadra fêmea de 3/8"



ISO 11168

mm - "	D mm	L mm	€	3	009560018
14	18,8	70	37,00		3 009560018
9/16					
16	21,4	70	37,00		3 009560020
5/8					
17,8	23,6	70	37,00		3 009560021
11/16					
20,8	27,0	70	37,00		3 009560022
13/16					

## 956F

chaves de caixa para velas quadra 3/8"



mm - "	Ø mm	L mm	€	1	009560114
14	18,8	70	41,50		
9/16					
16	20,5	70	51,50		1 009560116
5/8					

## 956L

chaves de caixa para velas quadra de 1/2", extremidades hexagonal, série longa



mm - "	Ø mm	L mm	€	2	009560214
14	19,0	250	69,50		2 009560214
9/16					
16	21,0	250	71,50		2 009560216
5/8					

## 957

chaves em T para velas com cardan

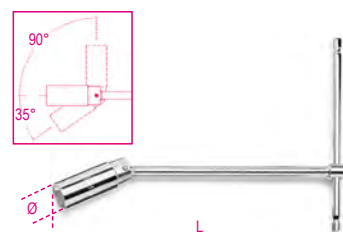

ISO 11168

mm - "	D mm	L mm	€	3	009570000
16	21,4	275	52,00		3 009570000
5/8					
20,8	27,0	275	61,50		3 009570001
13/16					



## 959

chaves em T para velas com cardan série normal

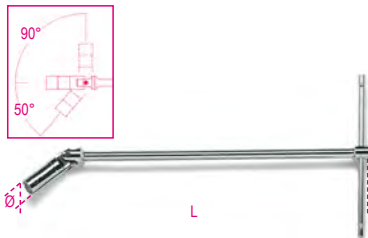

ISO 11168

mm -"	D mm	L mm	€		
14 9/16	18,8	483	60,50	3	009590009
16 5/8	21,4	483	67,50	3	009590010
20,8 13/16	27,0	527	89,50	3	009590011

## 959R

aplicações em borracha e molas de substituição para artigos 956C - 956E - 957 - 959

	€		
959R/14 956C/14-956E/14	6,30	3	009590223
959R/16 956C/16-956E/16 957/16-959/16	6,30	3	009590224
959R/17,8 956C/17,8-956E/17,8	6,30	3	009590225
959R/20,8 956C/20,8-956E/20,8 957/20,8-959/20,8-959L	6,30	3	009590226

## 960A

chave de caixa para injectores de motores Diesel, quadra fêmea de 1/2"

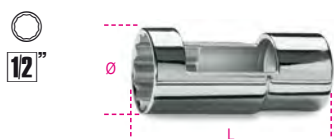

mm	D mm	L mm	€		
27	36,5	77	57,50	2	009600017

## 960ER

saca-anilhas de injectores

Extremidade roscada



L mm	€		
350	70,50	1	009600726

## 960SL

chaves de caixa para sonda Lambda com quadra fêmea de 1/2"



	Ø mm	€		
960SL 85 ○ 22xL= 85 mm	33	68,50	2	009600085
960SL 110 ○ 22xL= 110 mm	33	77,50	2	009600110

## 960SN

chaves para velas de incandescência de motores Diesel



mm	D mm	□	L mm	€		
8	12,0	1/4	60	58,00	2	009600834
9	13,3	1/4	60	58,00	2	009600835
10	14,5	3/8	70	69,00	2	009600836

## 960T/C11

Conjunto de chaves de caixa para remoção/ instalação de sensores

Inclui:

- 1 chave de caixa de sextavada de dupla entrada, tamanho 1" - 11/16" (para sensores da pressão do óleo)
- 1 chave de caixa sextavada aberta, 29 mm, para sensores de oxigénio
- 1 chave de caixa bi-sextavada aberta, 27 mm, para injectores
- 1 chave de caixa sextavada aberta, 22 mm, para vacuostatos
- 1 chave de caixa sextavada aberta, 22 mm, 80 mm de comprimento, para sensores de oxigénio
- 1 chave de caixa sextavada aberta, 22 mm, 90 mm de comprimento, para sensores de oxigénio
- 1 chave de caixa sextavada aberta, 22 mm, compacta, 30 mm de comprimento, para sensores de oxigénio
- 1 chave de caixa sextavada aberta, 22 mm, compacta, 50 mm de comprimento, para sensores de oxigénio
- 1 chave de caixa sextavada e bi-sextavada aberta, 22 mm, compacta, 34 mm de comprimento, para sensores de oxigénio
- 1 chave de caixa sextavada aberta, 22 mm, forma tubular
- 1 macho M18x1.5



○ 22 - 29 mm

	€		
960T/C11 ≡ 330x270x25 mm	226,00	1	009600031

## 960/C6

Chave de caixa sextavada fêmea 3/8" para instalar sensores de temperatura de gases de escape

O kit inclui:

- 3 packs de versão curta, 13, 14 e 17mm
- 3 packs de versão longa, 13,14 e 17mm



960/C6	€		
≡ 170x120x50 mm	95,50	1	009600055

## 960AVE

dispositivo de teste de injectores eléctricos diesel common rail



960AVE	€		
≡ 430x310x50 mm - 2,0 kg	305,00	1	009600245

## 960EPC/L

Conjunto de ferramentas de extração do eletrodo de velas incandescentes

M8x1 - M9x1 - M10x1 - M10x1.25



960EPC/L	€		
≡ 270x230x80 mm - 2 kg	1.000,00	1	009600890



## 960E-PI/P

extractor de anilhas de injetor

- Rosca macho M10 para utilização com o extractor de percussão (Beta 1540)



960E-PI/P € 78,50 1 009600706  
300x90x60 mm

## 960KC-M8/M9/M10

Jogo de ferramentas para remoção de velas de incandescência danificadas ou partidas

- Para velas de incandescência com rosca M8-M9-M10



960KC-M8/9/10 € 510,00 1 009600801  
380x290x50 mm - 2,3 kg

## 960KPC

Extractor por impulso reversível com binário ajustável para velas de incandescência

1/4"  
CE



960KPC € 365,00 1 009600780  
8-9-10-11-12 mm  
420x185x60 mm - 2,8 kg

## 960UC

Jogo de ferramentas para extração de velas de incandescência M8-M9-M10 com pontas danificadas



960UC € 580,00 1 009600900  
270x230x80 mm - 2,6 kg

## 960P

aparelho de teste de compressão/descompressão com acessórios e adaptadores



960P € 300,00 1 009600777  
350x320x95 mm - 1,9 kg

## 960PI

jogo de escareadores para limpeza do alojamento dos injectores em estojo de plástico

Para remover resíduos do alojamento do injetor

- Escareador plano, Ø 19 - 15 mm, para injectores universais
- Escareador plano, Ø 17 - 17 mm, para injectores Delphi/Bosch (BMW/PSA/Renault/Ford)
- Escareador plano, Ø 19 - 17 mm, para injectores Bosch (Mercedes CDI).
- Escareador angular, Ø 21 - 17 mm, para injectores Fiat/Iveco
- Punho



960PI € 140,00 1 009600215  
250x130x50 mm - 600 g

## 960PI/C19

jogo de 19 ferramentas para limpeza de base de injectores

Inclui:

- 11 mandris planos, Ø: 14/14 mm - 15.5/15.5 mm - 15/19 mm - 17/19 mm - 17/17.5 mm - 17/19 mm - 17/19.5 mm - 17/20 mm - 18/21 mm - 19 mm - 20/21 mm
- 4 mandris angulares, Ø: 15.5/15.5 mm - 17/17 mm - 17.5/20.5 mm - 17/21 mm
- Acessórios para mandris e punhos



960PI/C19 € 350,00 1 009600217  
360x230x60 mm

## 960PI/K36

kit de escovas para limpeza do alojamento dos injectores

1/4"



DIN 3126 E6,3

960PI/K36 € 221,00 1 009600218  
L 100 mm  
350x255x74 mm - 1253 g

## 960PI/S

kit limpeza do alojamento dos injectores

Inclui:

- 3 escovas de aço, Ø 18, 22, 25 mm, para limpeza de suportes de injectores
- 2 escovas, Ø 14 e 16 mm para limpeza do fundo dos suportes
- 6 tampas para o acesso à câmara de combustão
- 1 escova para limpeza do acesso à câmara de combustão
- 1 porta-bits flexível com punho



960PI/S € 185,00 1 009600214  
360x140x50 mm - 700 g

## 960VTC

dispositivo para teste de fugas para cilindros de motores a gasolina após a introdução de ar comprimido no cilindro, o dispositivo permite testar se existem fugas de compressão



960VTC	€ 322,00	1	009600261
373x295x70,6 mm - 2,3 kg			

## 960RPI

Soprador do alojamento dos injetores

Para velas de incandescência M8x1 - M9x1 - M10x1 - M10x1.25



960RPI	€ 223,00	1	009600940
--------	----------	---	-----------

## 960PMC

bomba manual para regulação e controlo de injetores Diesel



Bar max. 600	€ 880,00	1	009600200
--------------	----------	---	-----------

## 961N

videoscópio eletrónico com sonda flexível e rotativa

- Ecrã TFT LCD 5"
- Suporta cartões SD
- Gravação de vídeo e imagem
- 4 LEDs
- Alimentação através de porta USB (bateria incorporada)
- Sonda rotativa
- Alta resolução



- CARACTERÍSTICAS TÉCNICAS:
- Resolução máxima: 1920X1080
  - Comprimento da sonda: 1500 mm
  - Diâmetro da câmara: 6 mm
  - Formatos de vídeo: AVI
  - Formatos de fotografia: JPEG
  - Ângulo de disparo: 0÷180°
  - Ajuste da sonda: 0÷360°
  - Grau de deteção da sonda: IP67
  - Saída de dados: Cabo USB-C e cartão SD
  - Fonte de alimentação: Bateria 3,7V 2000 mAh

961N	€ 525,00	1	009610030
------	----------	---	-----------

## 961P6/S

sondas flexíveis, 6 mm para videoscópio 961P6



	L mm	€	1	009610006
961P6/S 1	1000	375,00	1	009610006
961P6/S 2	2000	420,00	1	009610262
961P6/S 3	3000	475,00	1	009610263

## 962

ferros de desmonta



L mm	A mm	€	5	009620003
300	21	28,00	5	009620003
400	25	33,50	5	009620004
500	27	43,00	3	009620005
600	27	56,50	3	009620006

## 962C



962C	270
------	-----

## 962P

alavanca de pneus com proteção anti-riscos



L mm	A mm	€	1 <th>009620049</th>	009620049
490	25	105,00	1	009620049

## 962M

ferramenta para desmontagem/ montagem de pneus

Instalação de pneus runflat e baixo perfil em todos os equipamentos.

- mordentes anti-riscos
- base de alavanca para remoção do pneu



962M	€ 375,00	1	009620501
------	----------	---	-----------

## 963

alavanca com extremidades chata e pontiaguda



L mm	A mm	€	5 <th>009630001</th>	009630001
400	23	42,50	5	009630001

## 964

alavanca com extremidades pontiaguda e em cunha



L mm	A mm	€	5 <th>009640001</th>	009640001
400	46	38,50	5	009640001

## 965

jogo de alavancas com pontas curvadas



L mm	A mm	L1 mm	€	2	009650013
300	16	185	19,80	2	009650013
450	20	312	28,00	2	009650014
600	20	462	32,50	2	009650016





965/S3 € 80,50 1 009650019

### 966/C3

Jogo 3 alavancas com cabeça articulada curvada

- Rotação da cabeça a 200°
- Bloqueio automático na posição pretendida



966/C3 € 148,00 1 009660103  
L=200-250-300 mm  
355x140x65 mm - 1,8 kg

### 720LS

chaves de impacto, série longa



720LS 36 € 69,00 2 007200386  
D L Ø1  
mm mm mm mm  
36 48,0 78 29

### 969B

chave de caixa para aperto da porca do cubo

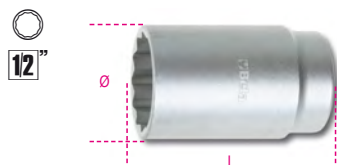

Ø	Ø	L	€		
mm	mm	mm			
24	36,0	76	25,00	1	009690124
27	36,0	76	25,50	1	009690127
30	40,0	76	26,50	1	009690130
31	42,0	76	27,00	1	009690131
32	42,5	76	29,00	1	009690132
34	45,0	76	32,00	1	009690134
35	46,0	76	32,50	1	009690135
36	49,0	76	37,50	1	009690136



### 969/C5

jogo de 5 chaves de caixa para cubos de roda em estojo de plástico



969/C5 € 158,00 1 009690201

969B 30-32-34-35-36

### 970B

chave de caixa para aperto da porca do cubo Fiat Daily

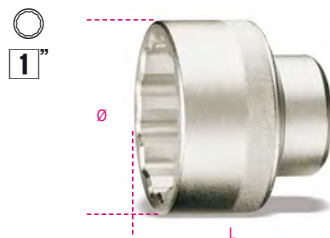

970B € 123,00 1 009700010  
Ø L  
mm mm mm  
65 88 75

### 970IVECO

chave de caixa para cubos de roda Iveco Daily para versões a partir de 2014

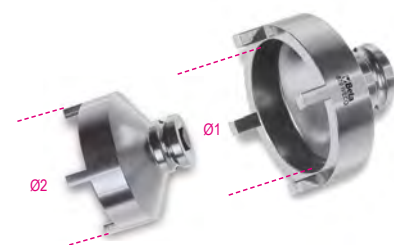

970IVECO € 74,00 1 009700011  
Ø1 Ø2  
mm mm  
61,5 74,8

### 971/C8

chave de aperto para válvulas de pneus, com acessórios e sistema de controlo de pressão para um aperto controlado



971/C8 € 465,00 1 009710108

583/6 1,2+6 Nm  
892/0  
862TX T10-T15-T20  
900L 11-12 mm  
986 78

### 972/C4BMW

kit para remoção de porcas anti-rubro, para BMW e Mini



972/C4 BMW € 269,00 1 009720004

516x145x66 mm - 3,8 kg

### 972/C10

kit extratores para cubos de roda danificados

para utilização em cubos anti-rubro e convencionais



972/C10 € 339,00 1 009720010

290x250x60 mm - 2,4 kg





## 973

Conjunto de 4 capas para rodas em nylon

Adequadas para as seguintes jantes:

14" ÷ 18" item número 009730014

19" ÷ 22" item número 009730019



- preserva e protege de riscos e poeiras
- previne deterioração precoce da borracha dos pneus de verão/ inverno armazenados
- icon identificador da roda (direita/esquerda frente ou direita/ esquerda traseira)
- com pegas para fácil transporte
- em nylon, lavável

	€		
973 14-18	119,00	1	009730014
973 19-22	132,00	1	009730019

## 978 - 979

chaves de cruz para porcas de rodas

12"

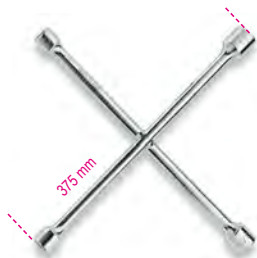

UNI/ISO 6788 DIN 3119

	€		
978	75,50	2	009780001
17x19x21x22 mm			
979	75,50	2	009790001
17x19x22x 1/2 mm			

## 982

chaves de cruz para porcas de rodas

3/4"



UNI/ISO 6788 DIN 3119

	€		
24x27x32x 3/4 mm	183,00	1	009820001

## 983PM

escova abrasiva para limpeza de cubos de roda

14"

12"



Ø1 mm	Ø2 mm	€		
90	150	88,00	1	009830010

## 983 PM/R-DA

discos abrasivos, par, para item 983PM



Ø mm	€		
150	81,50	1	009830050

## 984

Alicate para tampa de plástico da porca da roda



L mm	H mm	€		
195	4	30,00	1	009840005

## 985/B7

jogo 7 pinos-guia para rodas

Tamanhos:

- M12x1.25 macho
- M12x1.25 fêmea
- M12x1.5 macho
- M12x1.5 fêmea
- M14x1.25 macho
- M14x1.5 macho
- M16x1.5 macho



C985/B7	€		
	117,00	1	009850007

## 985M

pinos-guia macho para rodas



	L mm	€		
985M M12X1,25	150	15,20	1	009850101
985M M12X1,50	150	15,20	1	009850102
985M M14X1,25	150	15,70	1	009850103
985M M14X1,50	150	15,70	1	009850104
985M M16X1,50	150	17,30	1	009850105

## 985F

pinos-guia fêmea para rodas



	L mm	€		
985F M12X1,25	150	20,30	1	009850106
985F M12X1,50	150	21,50	1	009850107

## 986 48

Chave de fendas para válvulas de pneus, modelo curto

Válvula de retenção automática



L mm	L1 mm	€		
18	48	17,30	1	009860048

## 986 78

Chave de fendas para válvulas de pneu

Válvula de retenção automática



L mm	L1 mm	€		
18	78	17,30	1	009860078



## 986PT

chave para válvulas de pneus, pré-calibrada, 0.4 Nm, retenção automática da válvula

Mecanismo de proteção da calafetagem da válvula



L mm	L1 mm	€	🔧	📦
19	120	60,50	1	009860140

## 987

Alavanca para válvulas de pneus com protecção em borracha



L mm	€	🔧	📦
310	35,50	1	009870001

## 987AR

alavanca para válvulas de pneus com apoio anti-riscos

- apoio em borracha e nylon para jantes de liga e de ferro
- encaixe rápido da válvula, sem necessidade de apertar



L mm	€	🔧	📦
305	117,00	1	009870021

## 987P

alavanca para válvulas de pneus em plástico

Punho permite trabalhar com a chave no mecanismo interno da válvula



L mm	€	🔧	📦
335	29,50	1	009870011

## 988/K4

Jogo de 4 escopros planos anti-riscos em plástico

- Particularmente adequados para remoção de vedantes adesivos em jantes de liga leve
- Arestas de corte em 3 lados para utilização mais versátil



988/K4	€	🔧	📦
A= 19-21-25-38 mm	31,00	1	009880104

## 989

alicate para pesos



L mm	€	🔧	📦
250	56,50	2	009890001

## 989A

Alicate de remoção de pesos de equilíbrio das rodas



Perfil com design específico para não marcar as jantes

989A	L mm	€	🔧	📦
	220	38,00	1	009890011

## 989B

alicate para remoção de pesos de equilíbrio das rodas

Funções:

- remoção de pesos adesivos para jantes de liga
- remoção de pesos para jantes de ferro
- martelo com cobertura PE-HD amovível para pesos adesivos e jantes de ferro
- mordentes de peso para jantes de ferro



L mm	€	🔧	📦
230	72,50	1	009890015

## 990

pinça de pontas finas, direitas e estriadas em aço inoxidável



L mm	€	🔧	📦
130	13,20	5	009900001

## 991

pinça de pontas finas, curvas e estriadas em aço inoxidável



L mm	€	🔧	📦
130	15,90	5	009910001

## 992

pinça com guia, pontas finas direitas e estriadas em aço inoxidável



L mm	€	🔧	📦
150	16,70	5	009920001

## 993

pinça com guia, pontas finas curvas e estriadas em aço inoxidável



L mm	€	🔧	📦
145	17,90	5	009930001

## 993PL

pinça com guia, pontas finas curvas e estriadas em aço inoxidável cobertura em PVC



L mm	€	🔧	📦
150	17,90	3	009930010



### 993G

pinça com guia, pontas finas, encurvadas e estriadas em aço inoxidável



L mm 160 € 16,40 3 009930030

### 994

pinça com pontas largas, direitas e estriadas em aço inoxidável



L mm 150 € 13,70 5 009940001

### 994PL

pinça com pontas largas, direitas e estriadas em aço inoxidável cobertura em PVC



L mm 150 € 16,40 3 009940010

### 994TF

pinça com pontas largas, direitas e estriadas em aço inoxidável anti-magnético e resistente a ácidos



L mm 150 € 21,90 3 009940020

### 996

pinça com pontas direitas espatuladas em aço inoxidável



L mm 150 € 14,50 5 009960001

### 998

pinça cruzada de pontas largas, direitas e estriadas em aço inoxidável



L mm 155 € 25,00 5 009980001

### 999

pinça com pontas chatas e arredondadas em aço inoxidável anti-magnético e resistente a ácidos



L mm 115 € 19,90 3 009990011

### 999A

pinça com pontas curtas e extra-finas em aço inoxidável anti-magnético e resistente a ácidos



L mm 120 € 17,20 3 009990015

### 999B

pinça com pontas direitas de grande resistência em aço inoxidável anti-magnético e resistente a ácidos



L mm 120 € 17,60 3 009990017

### 999C

pinça com pontas direitas e extra-finas em aço inoxidável anti-magnético e resistente a ácidos



L mm 110 € 19,30 3 009990019

### 999D

pinça com pontas extra-finas angulares em aço inoxidável anti-magnético e resistente a ácidos



L mm 115 € 21,30 3 009990021

### 999E

pinça com pontas curvas extra-finas em aço inoxidável anti-magnético e resistente a ácidos



L mm 120 € 19,30 3 009990023

### 999G

pinça de pontas direitas extra-finas com dispositivo de bloqueio em aço inoxidável anti-magnético e resistente a ácidos



L mm 140 € 19,30 3 009990027

### 999/B6N

jogo de 6 pinças, antimagnéticas e resistentes a ácidos



999/B6N € 124,00 1 009990060  
999-999A-999B  
999C-999D-999E

### 1002

pinça de pontas redondas estriadas com bloqueio, em aço inoxidável



L mm 160 € 31,00 2 010020001



## 1008

alicate de pontas chatas longas, com estrias, e punhos de dupla camada de PVC

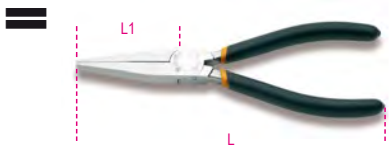

ISO 5745

L mm	L1 mm	€	🔧	📦
160	51,5	28,50	5	010080006

## 1008BM

alicate de pontas chatas longas, com estrias, e punhos bi-material



ISO 5745

L mm	L1 mm	€	🔧	📦
160	51,5	34,50	3	010080036

## 1009

alicates de pontas estriadas extra-longas, punhos com dupla camada de PVC anti-deslizamento



ISO 5745

L mm	L1 mm	€	🔧	📦
160	56,5	28,50	2	010090006

## 1009L/A

alicate para trabalhos especiais de pontas semi-redondas extra-longas, com estrias, e punhos de dupla camada de PVC



L mm	L1 mm	€	🔧	📦
283	80	34,50	2	010090008

## 1009L/B

alicate para trabalhos especiais de pontas semi-redondas extra-longas, curvas a 45°, com estrias, e punhos de dupla camada de PVC



L mm	L1 mm	€	🔧	📦
273	73	35,00	2	010090009

## 1009L/C

alicate para trabalhos especiais de pontas semi-redondas extra-longas, curvas a 90°, com estrias, e punhos de dupla camada de PVC



L mm	L1 mm	€	🔧	📦
253	45	37,50	2	010090010

## 1009L/D

alicate extralongo, nariz dentado duplo giratório, pegas com revestimento duplo em PVC antiderrapante



L mm	L1 mm	€	🔧	📦
342	71	41,50	1	010090058

## 1009L/DP

alicate curvo extralongo nariz dentado duplo giratório, 45°, pegas com revestimento duplo em PVP antiderrapante



L mm	L1 mm	€	🔧	📦
336	66	41,50	1	010090059

## 1009L/DP-S2

Jogo de 2 alicates para trabalhos especiais de pontas semi-redondas extra-longas



1009L/DP-S2	€	🔧	📦
	83,00	1	010090060

## 1010

alicate de pontas redondas extra-longas e punhos de dupla camada de PVC



ISO 5745

L mm	L1 mm	€	🔧	📦
160	51,5	28,50	2	010100006

## 1010BM

alicate de pontas redondas, com estrias, e punhos bi-material



ISO 5745

L mm	L1 mm	€	🔧	📦
160	51,5	34,50	2	010100036



# ALICATES DE FREIOS (TIPO SEEGER)

## ALINHAMENTO PERFEITO

Os testes mostraram que os alicates de freios da Beta proporcionam um excelente alinhamento seeger (anel retentor), com base na geometria especial de cone reverso das pontas, obtida através da tecnologia exclusiva de prensagem a frio.



## QUEBRA DE PONTAS REDUZIDA

Os alicates Beta estão equipados com pontas prensadas a frio embutidas, que proporcionam maior durabilidade em comparação com os concorrentes, tanto em termos de utilização como em caso de quedas acidentais.



## 1034L

alicate de freios interiores com pontas curvas a 90° e punhos em PVC



L mm	∅ mm	€	🛒	📄
190	40÷100	78,50	2	010340320

## 1036

alicates de freios exteriores com pontas direitas e punhos de PVC



UNI 7915 DIN 5254

L mm	∅ mm	€	🛒	📄
140x0,9	3÷10	29,00	5	010360013
140x1,3	10÷25	28,50	5	010360014
175	19÷60	29,50	5	010360017
225	40÷100	37,50	3	010360021
300	85÷200	58,50	2	010360028

## 1031/S4

Jogo de 4 alicates de freios



1031/S4	€	🛒	📄
1032 180 ∅ 19 ÷ 60 mm	122,00	1	010310000
1034 170 ∅ 19 ÷ 60 mm			
1036 175 ∅ 19 ÷ 60 mm			
1038 175 ∅ 19 ÷ 60 mm			

## 1032

alicates de freios interiores com pontas direitas e punhos em PVC



UNI 7914 DIN 5256

L mm	∅ mm	€	🛒	📄
140x0,9	8÷12	27,00	5	010320013
140x1,3	12÷25	26,50	5	010320014
180	19÷60	28,50	5	010320017
225	40÷100	35,00	3	010320021
300	85÷200	49,00	2	010320028

## 1033

alicates de freios interiores com pontas curvas a 45° e punhos em PVC



UNI 7914 DIN 5256

L mm	∅ mm	€	🛒	📄
140x0,9	8÷12	30,50	5	010330013
140x1,3	12÷25	29,50	5	010330014
180	19÷60	31,00	5	010330017
225	40÷100	38,50	3	010330021

## 1034

alicates de freios interiores com pontas curvas a 90° e punhos em PVC



UNI 7914 DIN 5256

L mm	∅ mm	€	🛒	📄
130x0,9	8÷12	30,50	5	010340013
130x1,3	12÷25	29,50	5	010340014
170	19÷60	31,00	5	010340017
210	40÷100	38,50	3	010340021
290	85÷200	54,50	2	010340028

## 1037

alicates de freios exteriores com pontas curvas a 45° e punhos em PVC



UNI 7915 DIN 5254

L mm	∅ mm	€	🛒	📄
140x0,9	3÷10	32,50	5	010370013
140x1,3	10÷25	31,00	5	010370014
175	19÷60	32,50	5	010370017
225	40÷100	40,00	3	010370021

## 1038

alicates de freios exteriores com pontas curvas a 90° e punhos em PVC



UNI 7915 DIN 5254

L mm	∅ mm	€	🛒	📄
135x0,9	3÷10	32,50	5	010380013
135x1,3	10÷25	31,00	5	010380014
175	19÷60	32,50	5	010380017
220	40÷100	40,00	3	010380021
300	85÷200	63,50	2	010380028

## 1039

alicate reversível com pontas direitas para freios interiores e exteriores com punhos em PVC



L mm	∅ mm	∅ mm	€	🔧	📦
150	10÷15	6÷25	68,50	2	010390015

## 1558/C4

ferramenta para anel retentor interno e externo, operada por parafuso

Encabadouro quadrado permite a aplicação de uma força elevada em ambas as condições de operação  
Pontas fornecidas:  
∅ 2.5-3-3.5 mm



1558/C4	∅ mm	∅ mm	€	🔧	📦
5,5 ÷ 77	5,5 ÷ 77	5,5 ÷ 77	195,00	1	015580100

330x220x50 mm - 900 g

## 1044N

alicate ajustável, fosfatado, charneira sobreposta, punhos com revestimento em PVC antiderrapante  
· modelo com 8 posições



L mm	A max mm	L1 mm	€	🔧	📦
250	46	48	31,50	5	010440025

## 1047

alicate ajustável de charneira fechada, com botão de bloqueio punhos com revestimento duplo em PVC antiderrapante



L mm	A max mm	L1 mm	€	🔧	📦
180	30	29	46,00	2	010470180
240	36	35	49,00	2	010470240
300	50	48	71,00	1	010470300



# 1048N - ALICATES DE CHARNEIRA FECHADA

PEGA EXCELENTE E MANUSEAMENTO PERFEITO



- Nova geometria do dente para uma fixação eficaz e segura em perfis hexagonais e cilíndricos
- Dentes reforçados por indução para maior durabilidade
- Maior ângulo da cabeça/punho para manuseamento ergonómico melhorado
- Retentor de contraste que evita o esmagamento accidental das mãos
- Punhos antiderrapantes com revestimento em PVC
- Manuseamento e conforto extraordinários graças à grande superfície de contacto do punho



## 1048N

alicate de charneira fechada, punhos anti-derrapantes com revestimento em PVC



ISO 8976

L mm	A max mm	L1 mm	S mm	€	🔧	📦
175	36	31	11	33,50	3	010480910
250	46	38	13	36,00	5	010480915
300	60	44	14.8	54,00	2	010480920
400	96	81	19	84,00	1	010480940

## 1048N/D3

jogo de alicates de charneira

cabeças fosfatadas



1048N/D3	€	🔧	📦
175-250-300 mm	124,00	1	010480923

## 1048BM

alicate ajustável, charneira fechada, punhos de 2 componentes  
· novo modelo com 9 posições



ISO 8976

L mm	A max mm	L1 mm	€	🔧	📦
250	48	39	48,50	3	010480215

## 1048VN

alicate ajustável de charneira fechada, lacado cor de laranja

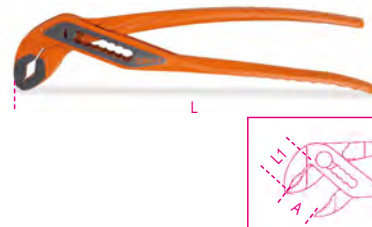

ISO 8976

L mm	A max mm	L1 mm	€	🔧	📦
175	36	31	28,50	3	010480111
250	46	38	32,50	5	010480116
300	60	44	47,50	2	010480121



### 1050

alicate de pressão com dupla regulação

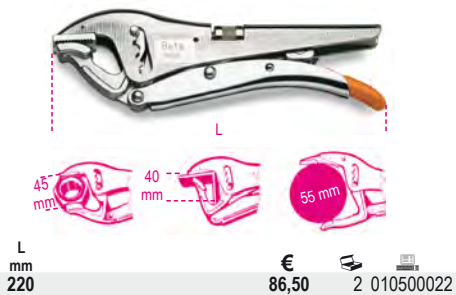

L mm 220 € 86,50 2 010500022

### 1051

alicate de pressão com dupla regulação maxilas longas

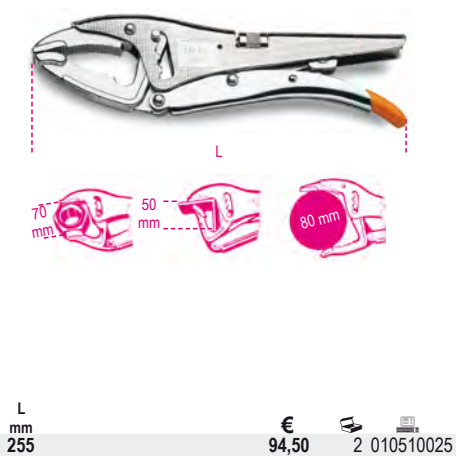

L mm 255 € 94,50 2 010510025

### 10516M

alicate de pressão com dupla regulação, maxila oscilante

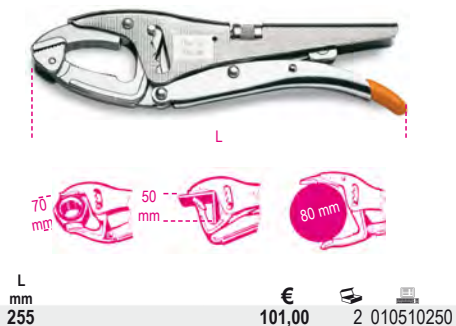

L mm 255 € 101,00 2 010510250

### 1051L

alicate de pressão de grande capacidade com dupla regulação

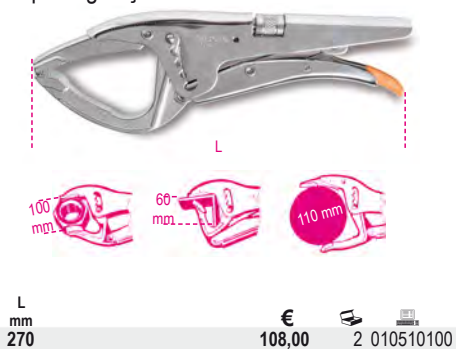

L mm 270 € 108,00 2 010510100

### 1051XL

alicate de pressão de grande capacidade com dupla regulação, mordentes extra-longos

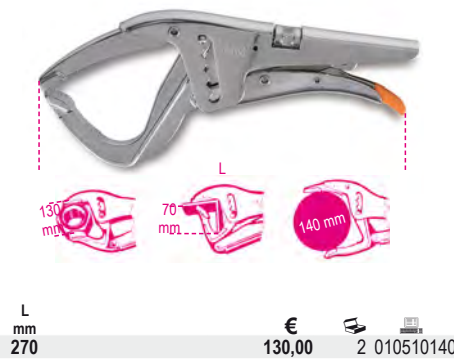

L mm 270 € 130,00 2 010510140

### 1052

alicates de pressão, maxilas côncavas

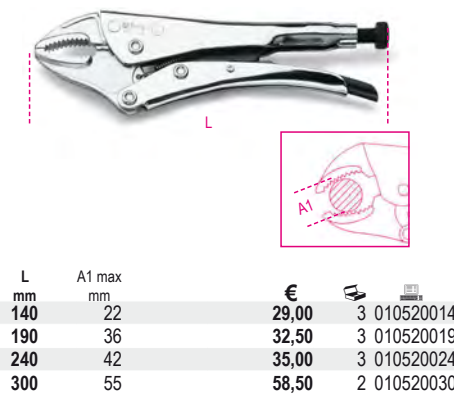

L mm	A1 max mm	€	Q	Artigo
140	22	29,00	3	010520014
190	36	32,50	3	010520019
240	42	35,00	3	010520024
300	55	58,50	2	010520030

### 1053

alicates de pressão, maxila oscilante

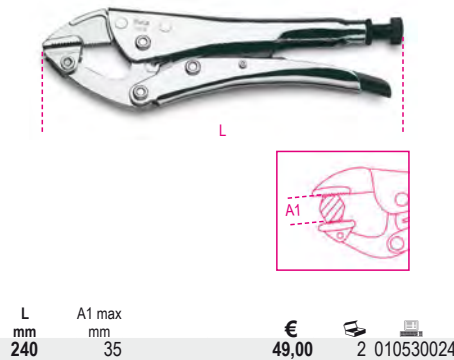

L mm	A1 max mm	€	Q	Artigo
240	35	49,00	2	010530024

### 1054

alicate de pressão, maxilas direitas

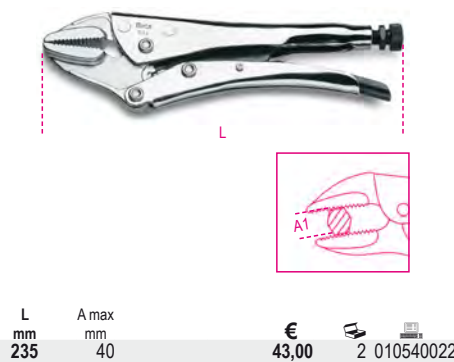

L mm	A max mm	€	Q	Artigo
235	40	43,00	2	010540022

### 1055

alicate de pressão, maxilas recurvadas

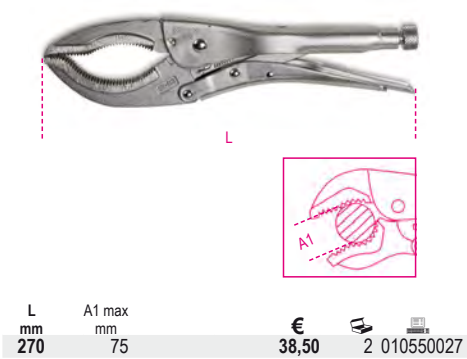

L mm	A1 max mm	€	Q	Artigo
270	75	38,50	2	010550027

### 1055D

alicate de pressão, para porcas e perfis cilíndricos

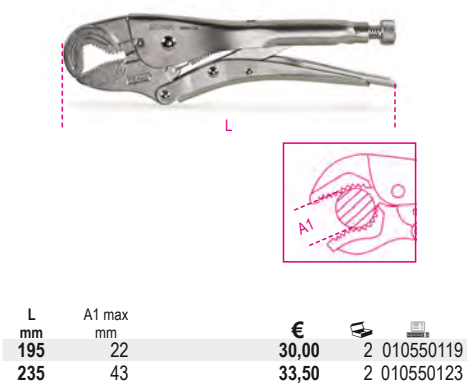

L mm	A1 max mm	€	Q	Artigo
195	22	30,00	2	010550119
235	43	33,50	2	010550123

### 1056

alicate de pressão pescoço de cisne para técnicos de refrigeração

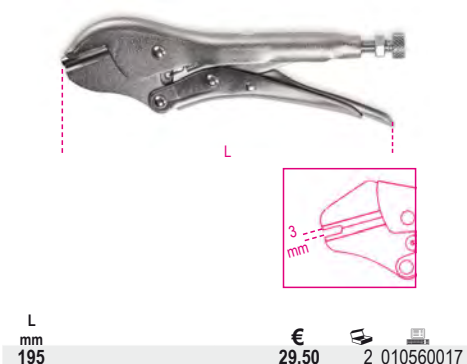

L mm	€	Q	Artigo
195	29,50	2	010560017

### 1057A

alicate ajustável com sistema autoblocante

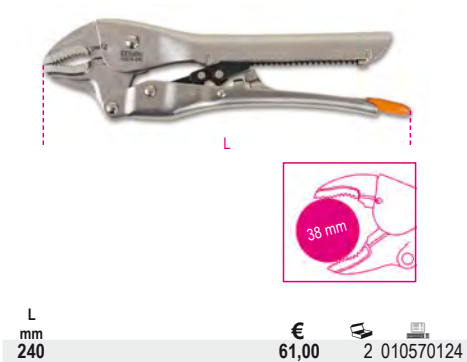

L mm	€	Q	Artigo
240	61,00	2	010570124

### 1058

alicates de pressão, bicos longos

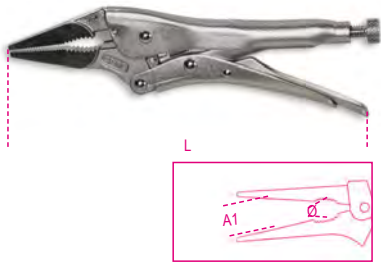

L mm	A1 max mm	Ø max mm	€	🔧	📦
175	34	26	37,00	2	010580017
225	46	31	44,00	2	010580025

### 1059

alicates de pressão com maxila deslizante

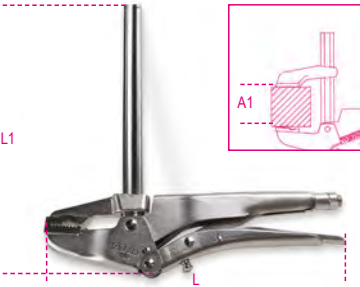

L1 mm	L mm	A1 mm	€	🔧	📦
160	255	120	66,00	1	010590016
270	255	220	69,00	1	010590027

### 1060

alicate de pressão para soldadura

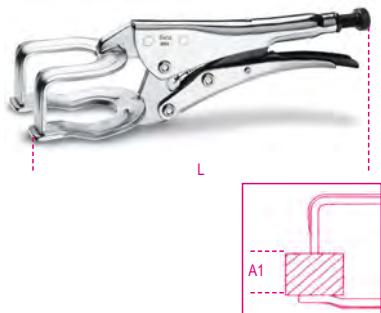

L mm	A1 max mm	€	🔧	📦
200	50	46,50	2	010600020
280	80	59,00	2	010600028

### 1061

alicate de pressão para soldadura

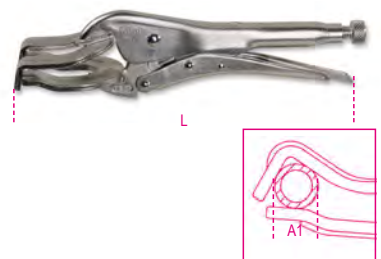

L mm	A1 max mm	€	🔧	📦
275	80	51,00	2	010610027

### 1062

alicates de pressão pescoço de cisne

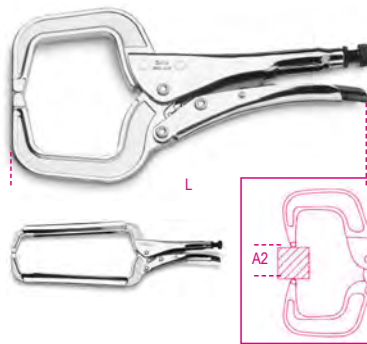

L mm	A1 max mm	€	🔧	📦
170	50	36,00	2	010620017
290	120	48,00	2	010620029
460	255	68,50	1	010620045

### 1062AL

alicate de pressão pescoço de cisne, maxilas em alumínio

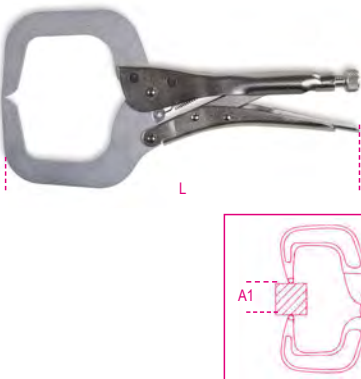

L mm	A1 max mm	€	🔧	📦
275	88	64,00	2	010620327

### 1062GM

alicate de pressão pescoço de cisne, maxilas oscilantes

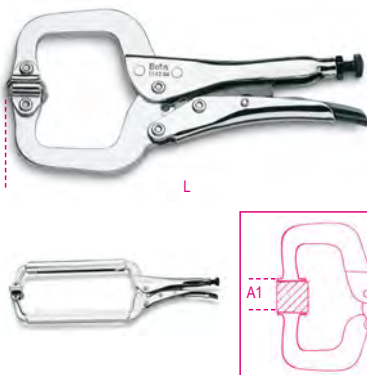

L mm	A1 max mm	€	🔧	📦
170	45	39,50	2	010620217
290	88	56,00	2	010620229
460	255	79,00	1	010620245

### 1063

alicate de pressão para latoeiros

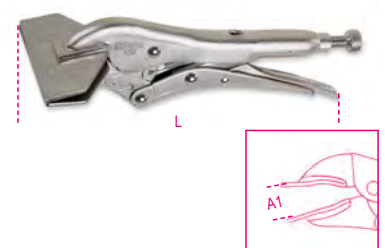

L mm	A1 max mm	€	🔧	📦
200	31	47,00	2	010630021

### 1064

alicate de pressão com corrente



L mm	Ø mm	€	🔧	📦
230	150	67,50	2	010640023

### 1065F

alicate de furar chapa



σ mm	L mm	€	🔧	📦
5	228	136,00	1	010650010
6	228	137,00	1	010650015

### 1065P

alicate de dobrar chapa



L mm	€	🔧	📦
228	140,00	1	010650020

## 1066

alicate de pressão,  
ângulo bloqueável a 90°

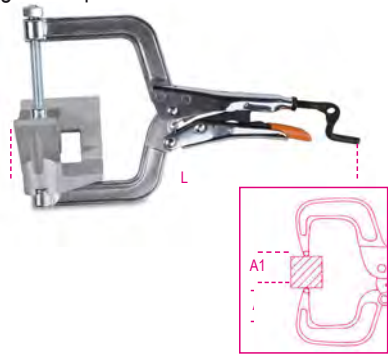

L	A1 max	g	€	🔧	📄
mm	mm				
210	55	500	89,00	1	010660021

## 1067

alicate de pressão ajustável para tubos, com  
maxila articulada

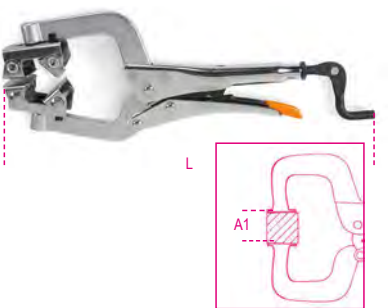

L	A1 max	€	🔧	📄
mm	mm			
285	76	56,50	1	010670285
380	89	58,00	1	010670380

## 1068



1068 161

## 1077

alicate de latoeiro com pontas largas  
e direitas, punhos com cobertura em PVC



L	A	L1	€	🔧	📄
~	mm	mm			
280	60	53	58,00	1	010770026

## 1078

alicate de latoeiro com pontas largas  
e curvas a 45°, punhos com cobertura  
em PVC



L	A	L1	€	🔧	📄
~	mm	mm			
280	60	77	59,00	1	010780026

## 1080D

alicate de corte diagonal raso com punhos  
com revestimento duplo em PVC

Para corte de plástico

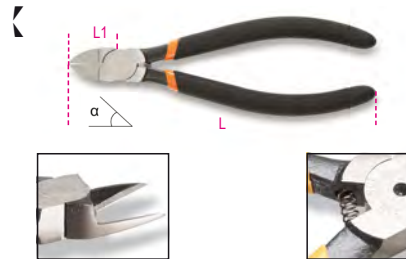

°	L	L1	€	🔧	📄
	mm	mm			
15°	160	22	31,00	3	010800015
45°	160	22	37,50	3	010800045

## 1081

Alicate de corte, punho anti-derrapante com  
revestimento duplo em PVC

• Para eletrônica e trabalhos pesados em micromecânica



L	L1	€	🔧	📄
mm	mm			
125	16	32,00	3	010810130

## 1082

alicates de corte diagonal  
com punhos de dupla camada em PVC



UNI/ISO 5749					
L	L1	mm	€	🔧	📄
mm	mm	mm			
140	20	1,6	28,00	5	010820004
160	22	1,6	29,00	5	010820006

## 1082G

alicate de corte diagonal,  
punhos com duplo revestimento PVC,  
acabamento industrial



UNI/ISO 5749					
L	L1	mm	€	🔧	📄
mm	mm	mm			
140	20	1,6	23,90	5	010820064
160	22	1,6	25,00	5	010820066

## 1082BM

alicates de corte diagonal,  
punhos bi-material



UNI/ISO 5749					
L	L1	mm	€	🔧	📄
mm	mm	mm			
140	20	1,6	34,50	3	010820034
160	22	1,6	38,00	3	010820036

## 1082GBM

alicate de corte diagonal,  
punhos bi-material,  
acabamento industrial



UNI/ISO 5749					
L	L1	mm	€	🔧	📄
mm	mm	mm			
140	20	1,6	30,50	3	010820264
160	22	1,6	34,00	3	010820266

## 1084

alicates de corte diagonal  
para serviços pesados com punhos  
de dupla camada em PVC



UNI/ISO 5749					
L	L1	mm	€	🔧	📄
mm	mm	mm			
160	22	1,6	32,50	5	010840006
200	28	2,0	40,50	3	010840010

## 1084G

alicates de corte diagonal para serviços  
pesados, punhos anti-deslizantes com dupla  
camada em PVC, acabamento industrial



UNI/ISO 5749					
L	L1	mm	€	🔧	📄
mm	mm	mm			
160	22	1,6	28,50	5	010840066
200	28	2,0	35,00	3	010840070



## 1084BM

alicates de corte diagonal para serviços pesados  
para serviços pesados  
punhos bi-material



UNI/ISO 5749

L mm	L1 mm	≠ mm	€	🔧	📄
160	22	1,6	39,50	3	010840036
200	28	2,0	51,00	3	010840040

## 1084GBM

alicates de corte diagonal para serviços pesados, punhos em bi-matéria, acabamento industrial



UNI/ISO 5749

L mm	L1 mm	≠ mm	€	🔧	📄
160	22	1,6	43,50	3	010840266
200	28	2,0	56,00	3	010840270

## 1088

alicates de corte frontal para serviços pesados com punhos de dupla camada em PVC



UNI/ISO 5748

L mm	L1 mm	≠ mm	€	🔧	📄
160	9	1,6	40,00	2	010880006
200	11	2,0	52,50	2	010880010

## 1088BM

alicates de corte frontal para serviços pesados, punhos bi-material



UNI/ISO 5748

L mm	L1 mm	≠ mm	€	🔧	📄
160	9	1,6	48,50	2	010880036
200	11	2,0	67,00	2	010880040

## 1092V

alicates de corte frontal articulados, serviço pesado



UNI/ISO 5748

L mm	L1 mm	≠ mm	€	🔧	📄
180	8	2,0	160,00	2	010920280
200	9	2,5	169,00	2	010920310

## 1094V

alicate de corte diagonal articulados, serviço pesado



UNI/ISO 5749

L mm	L1 mm	≠ mm	€	🔧	📄
200	23	2,5	160,00	2	010940200

## 1095N

alicate de corte diagonal



L mm	L1 mm	≠ mm	€	🔧	📄
195	26	1,6	56,50	2	010950010

## 1096

tenazes de carpinteiro



ISO 9243

L mm	L1 mm	€	🔧	📄
160	21	21,50	5	010960016
200	23	25,00	5	010960020
250	30	33,50	5	010960025

## 1098

turquês para cofragens



ISO 9242 DIN 5242

L mm	L1 mm	€	🔧	📄
190	12	21,50	5	010980190
220	13	24,30	5	010980220
250	15	29,00	5	010980250
280	18	32,00	5	010980280

## 1098PL

turquês para cofragens punhos revestidos a PVC



ISO 9242 DIN 5242

L mm	L1 mm	€	🔧	📄
220	13	27,00	5	010980320
250	15	31,00	5	010980350
280	18	34,00	5	010980380

## 1101

corta-parafusos



L mm	L mm	€	🔧	📄
300	12	64,00	2	011010030
350	14	78,00	2	011010035
450	18	95,50	1	011010045
600	24	131,00	1	011010060
750	30	169,00	1	011010075
900	36	225,00	1	011010090

L mm	R = 80 Kg/mm² Ø mm	R = 140 Kg/mm² Ø mm	g	🔧
300	5	4	745	🔧
350	6	5	1043	🔧
450	7	6	1537	🔧
600	9	7	2540	🔧
750	11	8	3870	🔧
900	12	9	6170	🔧

## 1101R

lâminas de substituição para o modelo 1101



mm	1101	€	🔧	📄
300	300	38,00	1	011010130
350	350	44,00	1	011010135
450	450	56,50	1	011010145
600	600	76,50	1	011010160
750	750	94,50	1	011010175
900	900	125,00	1	011010190

## 1102

corta-parafusos

R= 80 Kgf/mm<sup>2</sup>



L	mm	€		
230	4	47,00	3	011020020

## 1103

corta-ferros para hastes, parafusos e redes eletrosoldadas de reforço de betão

Ø máx. = 12 mm  
Ø máx. (HRC 48) = 6 mm



L	mm	€		
950		170,00	1	011030090

## 1103R

cabeça de substituição para item 1103



1103R 950	€		
	101,00	1	011030190

## 1104

corta cabos de aço para serviços pesados, com punhos em material termoplástico



R=80 Kgf/mm<sup>2</sup>

L	mm	mm	€		
420	12		164,00	1	011040004
600	16		239,00	1	011040006

## 1104R

lâminas de substituição para artigo 1104



mm	€		
420	102,00	1	011040014
600	142,00	1	011040016

## 1105

vazador de juntas



D	L	€		
2	27	17,30	1	011050002
3	27	17,30	1	011050003
4	27	17,30	1	011050004
5	27	17,30	1	011050005
6	27	17,30	1	011050006
7	27	17,30	1	011050007
8	27	17,30	1	011050008
9	27	17,30	1	011050009
10	27	17,30	1	011050010
12	27	21,20	1	011050012
14	27	21,20	1	011050014
16	27	21,20	1	011050016
18	27	21,20	1	011050018
20	27	21,20	1	011050020
22	32	26,50	1	011050022
24	32	26,50	1	011050024
26	32	26,50	1	011050026
28	32	26,50	1	011050028
30	32	26,50	1	011050030
32	37	34,50	1	011050032
34	37	34,50	1	011050034
36	37	34,50	1	011050036
38	37	34,50	1	011050038
40	37	34,50	1	011050040
42	42	40,50	1	011050042
44	42	40,50	1	011050044
46	42	40,50	1	011050046
48	42	40,50	1	011050048
50	42	40,50	1	011050050

## 1105T20

adaptador para punções 1105, 2 a 20 mm



L	mm	€		
110		86,00	1	011050200

## 1105T30

adaptador para punções 1105, 3 a 30 mm



L	mm	€		
175		185,00	1	011050205

## 1105T50

adaptador para punções 1105 2 a 50 mm



L	mm	€		
175		183,00	1	011050207

## 1105AD-50

adaptador para ref. 1105T50



Ø	mm	€		
57		115,00	1	011050210

## 1105/C10T

sortido de 10 punções, 3 a 20 mm, e 1 acessório



1105C/10T	€		
	192,00	1	011050250

1105 3 - 4 - 6 - 8 - 10 - 12 - 14 - 16 - 18 - 20 mm  
1105T20  
135x92x32 mm

## 1105/C16T

sortido de 15 punções, 3 a 30 mm, e 1 acessório



1105C/16T	€		
	346,00	1	011050255

1105 3 - 4 - 6 - 8 - 10 - 12 - 14 - 16 - 18 - 20 - 22 - 24 - 26 - 28 - 30 mm  
1105T30  
240x210x60 mm

## 1105/C32T

sortido de 29 punções,  
2 a 50 mm, e 3 acessórios



1105C/32T € 675,00 1 011050257

1105 2-3-4-5-6-7-8-9-10-12-14-16-18-20-22-24-26-28-30-32-34-36-38-40-42-44-46-48-50 mm

1105T50  
1105AD-50  
455x380x115 mm

## 1112

tesoura modelo americano  
lâminas largas e direitas

R =  $\frac{2}{3}$  60 Kgf/mm<sup>2</sup>



L	L1	S	A	€	Q	Art
mm	mm	mm	mm			
200	50	0,5	26	28,50	2	011120020
250	62	0,8	33	34,00	2	011120025
300	76	1,0	37	44,00	2	011120030
375	76	1,2	44	65,00	1	011120037

## 1114

tesoura de lâminas estreitas e direitas para  
metal mole

R = 60 Kgf/mm<sup>2</sup>

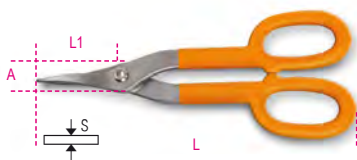

L	L1	S	A	€	Q	Art
mm	mm	mm	mm			
250	58	0,5	15	30,50	1	011140265
350	76	1	22	40,00	1	011140340

## 1118

tesoura para cintas de embalagem

Fe = aço normal  
Inox = aço inoxidável



L	L1	Fe	Inox	€	Q	Art
mm	mm	S mm	S mm			
310	42	1	0,8	49,50	2	011180001

## 1120A

tesoura para cortar metal

Fe = aço macio



L	Fe	€	Q	Art
mm	S mm			
280	1,2	80,00	1	011200101

## 1120ARL - ARG

peças de substituição para artigo 1120A



Art	€	Q	Art
1120ARL	19,90	1	011200110
1120ARG	25,00	1	011200120

## 1122

tesoura articulada lâminas direitas

Inox = aço inoxidável



L	L1	Inox	A	€	Q	Art
mm	mm	S mm	mm			
250	40	1	24	38,50	2	011220020

## 1122L

tesouras de lâminas longas para cortes retos

Inox = aço inox



L	L1	Inox	€	Q	Art
mm	mm	S mm			
288	98	1	39,50	2	011220035

## 1123

tesoura articulada de lâminas curvas  
para contornos a direita

Inox = aço inoxidável

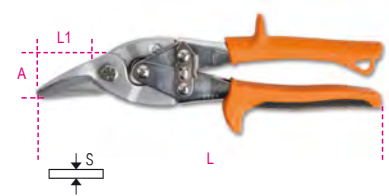

L	L1	Inox	A	€	Q	Art
mm	mm	S mm	mm			
250	40	1	24	38,50	2	011230020

## 1124

tesoura articulada de lâminas curvas  
para contornos a esquerda

Inox = aço inoxidável



L	L1	Inox	A	€	Q	Art
mm	mm	S mm	mm			
250	40	1	24	38,50	2	011240020

## 1125

tesoura articulada para cortes rectilíneos  
e contornos a direita

Inox = aço inoxidável

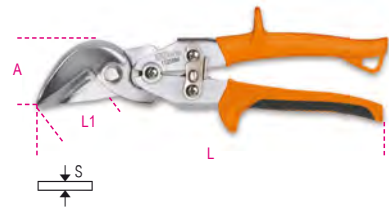

L	L1	Inox	A	€	Q	Art
mm	mm	S mm	mm			
250	35	1	46	60,00	2	011250020

## 1126

tesoura articulada para cortes rectilíneos  
e contornos a esquerda

Inox = aço inoxidável

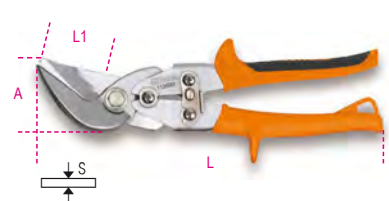

L	L1	Inox	A	€	Q	Art
mm	mm	S mm	mm			
250	35	1	46	60,00	2	011260020

## 1122 - 1125MOL

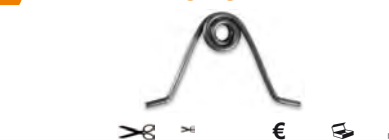

Art	Art	€	Q	Art
1122 MOL	1122 - 1124	1,72	1	011220010
1123 MOL	1123	1,46	1	011230010
1125 MOL	1125 - 1126	1,46	1	011250040



# 1128FXS TESOURA DE ELETRICISTA COM PERFIS DE ESCAREAÇÃO GRADUADOS

Para reformular a nossa tesoura de electricista observámos o trabalho diário dos utilizadores. Transformámo-la numa ferramenta universal, incorporando as 4 principais características num único utensílio.

**CORTAR** Rapidez e afiação, para cabos até 50 mm<sup>2</sup>, com uma ranhura para corte de cabos e lâmina micro dentada, para uma retenção melhorada.

**DESCARNAR** O pino anti-folga permite descarnar de forma precisa até os cabos mais finos.

**CRAVAR** Com segurança e resistência, para terminais de tubos

**ESCAREAR** O perfil de escareação exclusivo permite alargar furos em plástico de forma precisa e limpa.



# 1128BAX TESOURA DE ELETRICISTA

com perfis de escareação graduados lâminas em aço inox com revestimento DLC

As tesouras 1128BAX destacam-se pelas suas lâminas com revestimento DLC

(diamond-like carbon Trata-se de um inovador revestimento à base de carbono: a elevada dureza e baixo atrito resultam da combinação de diamante e carbono, sob a forma de grafite.

- Elevada dureza da superfície da lâmina - resistência à abrasão e desgaste
- Baixa fricção - suavidade e anti-aderência

Perfil de corte: concebida para alargar furos em plástico, de 13 mm a 25 mm.



**+ DUREZA**  
**- COEFICIENTE DE FRICÇÃO**



## 1127

tesouras para técnico de telefones lâminas direitas



L mm	L1 mm	€	5	011270001
150	35	16,70		

## 1128BAX

Tesoura de electricista com perfis de escareação graduados, lâminas em aço inox com revestimento DLC

Gumes de corte duplo: pino excêntrico especial permite que as lâminas se movimentem a todo o comprimento, aumentando a eficiência de corte.

Concebida para alargar furos em plástico, de 13 mm a 25 mm.

Revestimento DLC (diamond-like carbon) é um revestimento inovador à base de carbono: a elevada dureza e baixo atrito resultam da combinação de carbono, sob a forma de grafite, e diamante.

- Elevada dureza da superfície da lâmina (resistência à abrasão e desgaste)
- Baixa fricção (suavidade e antiaderência)
- Pino excêntrico especial
- Punhos de grandes dimensões com ranhura para corte de cabos e cravagem de terminais
- Com caixa em plástico articulada



L mm	L1 mm	mm <sup>2</sup>	€	5	011280088
150	50	50	37,00		

## 1128BMX

tesoura para electricistas, lâminas direitas em aço inoxidável, com micro-dentes



L mm	L1 mm	€	5	011280051
147	58,2	19,60		

## 1128BMX/F

estojo em plástico articulado para item 1128BMX



1128BMX/F	€	1	011280059
	1,98		

## 1128BSX

tesoura de electricista com perfis de escareação graduados, em caixa



L mm	L1 mm	€	5	011280061
148	58,2	33,50		

## 1128FX

tesoura de electricista, lâminas direitas em aço inox, com micro-dentado, ranhura para corte de cabos e alicate para cravagem de terminais

- Bolsa para cinto
- Punhos bi-material
- Pino de regulação de folga



L mm	L1 mm	mm <sup>2</sup>	€	5	011280090
145	52	50	35,50		



## 1128FXS

tesoura de electricista com perfis de escareação graduados, lâminas direitas em aço inox, com micro-dentado, ranhura para corte de cabos e alicate para cravagem de terminais

- Bolsa para cinto
- Punhos bi-material
- Pino de regulação de folga

• Concebida para alargar furos em plástico de 13 a 21 mm.



L	L1	mm <sup>2</sup>	€	Unid.	Art.
145	52	50	42,50	5	011280095

## 1128BM

tesouras de lâminas direitas para electricistas



L	L1	€	Unid.	Art.
145	50	17,00	5	011280000

## 1130BMX

tesoura multiusos, lâminas direitas em aço inox, com micro-dentado



L	L1	€	Unid.	Art.
185	60	22,00	1	011300002

## 1131CK

tesoura para Kevlar® e fibra óptica



L	L1	€	Unid.	Art.
203	75	88,00	1	011310001

## 1132

corta-cabos para cabos isolados de cobre e alumínio com punhos de dupla camada em PVC



UNI 8791

L	mm	mm <sup>2</sup>	€	Unid.	Art.
170	14	50	54,50	2	011320107
230	18	95	67,00	2	011320113

## 1132BM

corta-cabos para cabos isolados de cobre e alumínio com punhos bi-material



UNI 8791

L	mm	mm <sup>2</sup>	€	Unid.	Art.
170	14	50	67,00	2	011320137
230	18	95	82,00	2	011320143

## 1133

corta-cabos para cabos em cobre, flexível

até 325 mm<sup>2</sup>



L	mm	mm <sup>2</sup>	€	Unid.	Art.
600	30	325	186,00	1	011330001

## 1133RL

lâminas de substituição para artigo 1133



Art.	€	Unid.	Art.
1133RL	140,00	1	011330011

## 1135

corta-cabos para cabos de aço



L	€	Unid.	Art.
190	44,50	2	011350001

## 1142BM

alicate para descarnar fio punhos bi-material



UNI 7923

L	mm <sup>2</sup>	mm	€	Unid.	Art.
160	0,5÷6	0-2,8	44,00	3	011420036

## 1143

alicates para descarnar fio com dispositivo de corte



L	mm <sup>2</sup>	mm	€	Unid.	Art.
165	0,5÷6	1-3,2	86,50	1	011430011

## 1143R

lâminas de substituição para artigo 1143

Art.	€	Unid.	Art.
1143R	21,90	1	011430011

## 1144D

alicate para descarnar cabo



L	mm <sup>2</sup>	mm	€	Unid.	Art.
170	4,5÷240	2,5-18	104,00	1	011440010

## 1144D/RG

gancho de substituição para artigo 1144D



Art.	€	Unid.	Art.
1144D/RG	34,50	1	011440012

## 1144D/RL

laminas de substituição para artigo 1144D

Art.	€	Unid.	Art.
1144D/RL	53,50	1	011440011



## 1144G

alicate para descarnar cabo

com lâmina ajustável para cortes longitudinais e transversais



L			€		
140	6÷75	2.8-12 mm	58,00	1	011440004

## 1144G/RL

lâmina sobresselente para artigo 1144G



1144G/RL	€		
	12,90	1	011440005

## 1144L

Ferramenta para descarnar, com profundidade de lâmina ajustável, para cortes longitudinais e transversais

com lâmina retrátil, suave e em forma de gancho



L			€		
145	6-150	4-28 mm	33,50	1	011440050

## 1144T

ferramenta de descarnar, tamanho de bolso, com cortante



L			€		
112	3,5 ÷ 9	40 g	23,30	1	011440060

## 1148A

alicates para descarnar fio, com ajuste e dispositivo de corte

10 mm<sup>2</sup> (8 AWG) fios flexíveis  
1,5 mm<sup>2</sup> (16 AWG) fios rígidos



L			€		
190	0,02÷10	0-4 mm	178,00	1	011480100

## 1148A/R

lâminas para artigo 1148A



1148A/R	€		
	76,50	1	011480102

## 1148B

alicates para descarnar fio, com ajuste e dispositivo de corte



L			€		
190	4÷16	2-5 mm	209,00	1	011480200

## 1148B/R

lâminas de substituição para artigo 1148B



1148B/R	€		
	95,50	1	011480202

## 1148P

Alicate de descarnar cabo, auto-ajustável, com cortante



L			€		
165	0.2-6	0-3.5 mm	49,50	1	011480300



## 1149F

alicate frontal de descarnar fio com lâmina de corte, com fecho automático



L		€		
175	0,2 ÷ 6	19,30	1	011490010

## 1150

alicates universais em cromado brilhante com punhos de dupla camada de PVC

• O encaixe descentrado aumenta a alavancagem, reduzindo o esforço, para uma poderosa capacidade de corte.



ISO 5746

L	L1		€		
mm	mm	mm			
160	42	1,6	24,70	5	011500046
180	46	1,8	27,00	5	011500048
200	50	2,0	29,00	5	011500050
220	50	2,0	32,00	2	011500052

## 1150G

alicate combinado para trabalhos pesados, punhos com duplo revestimento PVC, acabamento industrial

• Excelente relação qualidade/preço  
• O encaixe descentrado aumenta a alavancagem, reduzindo o esforço, para uma capacidade de corte poderosa.



ISO 5746

L	L1		€		
mm	mm	mm			
160	42	1,6	23,00	5	011500066
180	46	1,8	25,00	5	011500068
200	50	2,0	28,00	5	011500070
220	50	2,0	29,00	2	011500072



INDUSTRIAL FINISHING



# 1150HPC Alicate Universal HyperCut

com arestas em aço sinterizado M2

- O pino descentralizado permite que o ponto de apoio fique mais próximo do ponto de corte, resultando num efeito de alavanca melhorado.
- As pontas perfeitamente alinhadas e o perfil fino garantem um aperto firme em qualquer espaço, inclusive em áreas extremamente reduzidas.
- Corpo do alicate em aço de molibdénio fiável, com tratamento térmico para garantir flexibilidade e resistência, bem como um aperto firme em qualquer condição.

Tensão de corte - teste estático =

**-73%**

Vida média das arestas de corte =  
(teste ISO 5744)

**+127%**

Dureza das arestas de corte em aço M2 =

**65HRC**

- **ABSOLUTAMENTE INOVADOR**
- **ACABAMENTO CROMADO PÉROLA**
- **NOTÁVEL CAPACIDADE DE CORTE**



## 1150HPC

alicate universal para serviços pesados com insert de corte e veio descentralizado punho bimaterial

insert de corte  
aço: M2  
espessura: 0.20 mm  
ângulo: 62°  
dureza: 63+65 HRC



ISO 5746

L mm	L1 mm	mm	€	🔧	📦
180	42	1,8	71,50	2	011500618

## 1150BM

alicates universais em cromado brilhante com punhos bi-material

- O encaixe descentrado aumenta a alavancagem, reduzindo o esforço, para uma poderosa capacidade de corte.



ISO 5746

L mm	L1 mm	mm	€	🔧	📦
160	42	1,6	30,50	3	011500146
180	46	1,8	33,50	3	011500148
200	50	2,0	37,00	3	011500150
220	50	2,0	39,50	2	011500152

## 1150GBM

alicate combinado para trabalhos pesados, punhos bi-material, acabamento industrial

- O encaixe descentrado aumenta a alavancagem, reduzindo o esforço, para uma poderosa capacidade de corte.
- Excelente relação qualidade/preço



ISO 5746

L mm	L1 mm	mm	€	🔧	📦
160	42	1,6	28,50	3	011500266
180	39	1,8	30,50	3	011500268
200	50	2,0	34,50	3	011500270
220	50	2,0	37,00	2	011500272

## 1153

alicates reguláveis com duas posições e punhos em PVC



UNI ISO 9343

L mm	L1 mm	€	🔧	📦
200	34	28,00	2	011530120

## 1162

alicates de pontas chatas extra-longas com estrias e punhos de dupla camada em PVC



ISO 5745

L mm	L1 mm	mm	€	🔧	📦
160	58	1,6	29,00	5	011620006
200	86	1,6	33,50	5	011620010



## 1162G

alicate de pontas chatas extra longas, com estrias, punhos anti-deslizantes com dupla camada de PVC, acabamento industrial

• Excelente relação qualidade/preço



ISO 5745

L mm	L1 mm	mm	€		
160	58	1,6	24,70	5	011620066
200	86	1,6	28,50	5	011620070

## 1162BM

alicates de pontas chatas extra-longas com estrias punhos bi-material



ISO 5745

L mm	L1 mm	mm	€		
160	58	1,6	35,00	3	011620036
200	86	1,6	39,50	3	011620040

## 1162GBM

alicate de pontas chatas extra longas, com estrias, punhos em bi-matéria, acabamento industrial

• Excelente relação qualidade/preço



ISO 5745

L mm	L1 mm	mm	€		
160	58	1,6	30,50	3	011620266
200	86	1,6	35,50	3	011620270

## 1164

alicates de pontas curvas chatas com estrias, extra-longas, e punhos de dupla camada de PVC



ISO 5745

L mm	L1 mm	mm	€		
160	54	1,6	31,50	5	011640006
200	76	1,6	35,00	5	011640010

## 1164BM

alicates de pontas curvas chatas com estrias, extra-longas, e punhos de dupla camada de PVC



ISO 5745

L mm	L1 mm	mm	€		
160	54	1,6	38,50	3	011640036
200	76	1,6	43,50	3	011640040

## 1166

alicates de pontas semi-redondas com estrias, extra-longas, e punhos de dupla camada de PVC



ISO 5745

L mm	L1 mm	mm	€		
160	56	1,6	29,00	5	011660006
200	76	1,6	33,50	5	011660010

## 1166G

alicate de ponta semi-redondas com estrias, extra-longas, punhos com duplo revestimento PVC, acabamento industrial

• Excelente relação qualidade/preço



ISO 5745

L mm	L1 mm	mm	€		
160	56	1,6	24,70	5	011660066
200	76	1,6	28,50	5	011660070

## 1166BM

alicates de pontas semi-redondas com estrias, extra-longas, e punhos bi-material



ISO 5745

L mm	L1 mm	mm	€		
160	56	1,6	35,00	3	011660036
200	76	1,6	39,50	3	011660040

## 1166GBM

alicate de pontas semi-redondas com estrias, extra-longas, punhos bi-material, acabamento industrial

• Excelente relação qualidade/preço



ISO 5745

L mm	L1 mm	mm	€		
160	56	1,6	30,50	3	011660266
200	76	1,6	35,50	3	011660270

## 1168

alicates de pontas curvas semi-redondas com estrias, extra-longas, e punhos de dupla camada de PVC



ISO 5745

L mm	L1 mm	mm	€		
160	54	1,6	31,50	5	011680006
200	76	1,6	35,00	5	011680010

## 1168G

alicates de pontas curvas extra longas, com estrias, punhos anti-deslizantes com dupla camada de PVC, acabamento industrial

• Excelente relação qualidade/preço



ISO 5745

L mm	L1 mm	mm	€		
160	54	1,6	27,00	5	011680066
200	76	1,6	30,50	5	011680070

## 1168BM

alicates de pontas curvas semi-redondas com estrias, extra-longas, e punhos bi-material



ISO 5745

L	L1	≠	€	🔧	📦
mm	mm	mm			
160	54	1,6	38,50	3	011680036
200	70	1,6	43,50	3	011680040

## 1168GBM

alicates de pontas curvas extra longas, punhos em bi-matéria, acabamento industrial

• Excelente relação qualidade/preço



ISO 5745

L	L1	≠	€	🔧	📦
mm	mm	mm			
160	54	1,6	34,00	3	011680266
200	70	1,6	38,50	3	011680270

## 1169/D3

jogo de 1 alicate universal, 1 alicate de pontas longas e 1 alicate de corte diagonal



1169/D3	€	🔧	📦
1082 160mm	85,00	1	011690053
1150 180mm			
1166 160mm			

## 1169G/D3

Conjunto de 1 alicate universal, 1 alicate de pontas semi-redondas longas e 1 alicate de corte, punhos em dupla camada de PVC anti-derrapante, acabamento industrial.

• Excelente relação qualidade/preço



INDUSTRIAL FINISHING

1169G/D3	€	🔧	📦
1082G 160mm	75,00	1	011690073
1150G 180mm			
1166G 160mm			

## 1169BM/D3

jogo de 1 alicate universal, 1 alicate de pontas redondas longas e 1 alicate de corte diagonal Punhos bi-material



1169BM/D3	€	🔧	📦
1082BM 160mm	107,00	1	011690133
1150BM 180mm			
1166BM 160mm			

## 1169GBM/D3

Conjunto de 1 alicate universal, 1 alicate de pontas semi-redondas longas e 1 alicate de corte, punhos bi-material, acabamento industrial.

• Excelente relação qualidade/preço



INDUSTRIAL FINISHING

1169GBM/D3	€	🔧	📦
1082GBM 160mm	95,50	1	011690273
1150GBM 180mm			
1166GBM 160mm			

## 1169N/D4

jogo de 1 alicate combinado para trabalhos pesados, 1 alicate de pontas longas, 1 alicate de corte cromado e 1 and 1 alicate ajustável de charneira fechada, fosfatado



1169N/D4	€	🔧	📦
1082 160 mm	122,00	1	011690024
1150 180 mm			
1166 160 mm			
1048N 250 mm			

## 1171BM

alicate de pontas chatas curtas, brunido punhos bi-material



ISO 9655

L	L1	A	B	€	🔧	📦
mm	mm	mm	mm			
130	18	12	8	48,00	2	011710101

## 1172BM

alicate de pontas chatas longas, brunido punhos bi-material

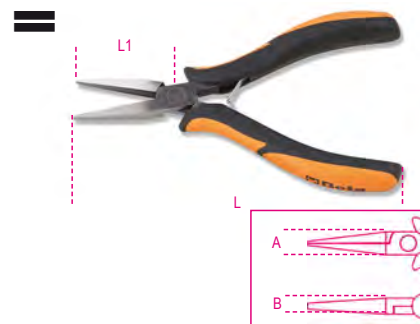

ISO 9655

L	L1	A	B	€	🔧	📦
mm	mm	mm	mm			
140	40	12	8	48,00	2	011720101



### 1172BM/P

alicate de pontas chatas curvas, brunido  
punhos bi-material



L	L1	A	B	€	Icon	Icon
~ 140	mm 38	mm 12	mm 13	55,50	2	011720102

### 1173BM

alicate de pontas redondas curtas, punhos bi-material



ISO 9655

L	L1	A	B	€	Icon	Icon
~ 125	mm 22	mm 12	mm 8	48,00	2	011730101

### 1175BM

alicate de pontas semi-redondas curtas, brunido  
punhos bi-material



ISO 9655

L	L1	A	B	€	Icon	Icon
~ 140	mm 29	mm 12	mm 8	48,00	2	011750101

### 1177BM

alicate de pontas semi-redondas longas, brunido  
punhos bi-material



ISO 9655

L	L1	A	B	€	Icon	Icon
~ 140	mm 38	mm 12	mm 8	48,00	2	011770101

### 1177BM/Z

alicate de pontas semi-redondas longas com estrias  
punhos bi-material



ISO 9655

L	L1	A	B	€	Icon	Icon
~ 140	mm 39	mm 12	mm 8	55,50	2	011770113

### 1178BM

alicate de pontas semi redondas longas, brunido  
punhos bi-material

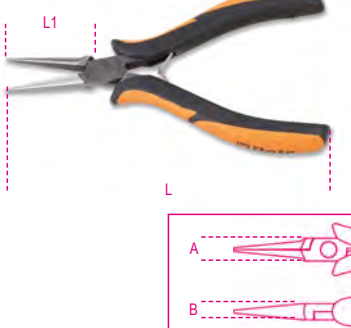

ISO 9655

L	L1	A	B	€	Icon	Icon
~ 140	mm 37	mm 12	mm 8	55,50	2	011780101

### 1178BM/P

alicate de pontas semi-redondas longas curvas, brunido  
punhos bi-material



L	L1	A	B	€	Icon	Icon
~ 140	mm 36,5	mm 12	mm 12	55,50	2	011780102

Alicate de corte diagonal, semi-raso pontas finas, punhos bi-material  
Para trabalhos mais fortes, ver item 1081

### 1182BM

alicate de corte diagonal, semi-raso pontas finas  
punhos bi-material



ISO 9654

L	L1	A	Cu	€	Icon	Icon
mm 120	mm 11	mm 10	mm 1	55,50	2	011820101



### 1183BM

alicate de corte diagonal, semi-raso  
pontas redondas  
punhos bi-material



ISO 9654

L mm	L1 mm	A mm	Cu mm	€	🔧	📦
120	11	10	1	55,50	2	011830101

### 1184BM

alicate de corte diagonal, raso  
pontas redondas  
punhos bi-material



ISO 9654

L mm	L1 mm	A mm	Cu mm	€	🔧	📦
120	11	10	1	55,50	2	011840101
130	13	12,5	1,25	55,50	2	011840102

### 1185BM

alicate de corte diagonal, raso  
pontas finas  
punhos bi-material



ISO 9654

L mm	L1 mm	A mm	Cu mm	€	🔧	📦
120	11	10	1	55,50	2	011850101
130	13	12,5	1,25	55,50	2	011850102

### 1186BM

alicate de corte diagonal, raso,  
pontas finas e estritas  
punhos bi-material



ISO 9654

L mm	L1 mm	A mm	Cu mm	€	🔧	📦
120	11	10	1	55,50	2	011860101
130	13	12,5	1,25	55,50	2	011860102

### 1188BM

alicate de corte diagonal normal  
punhos bi-material



ISO 9654

L mm	L1 mm	A mm	Cu mm	€	🔧	📦
125	12	12	1,25	55,50	2	011880101
130	17	15	2	55,50	2	011880102

### 1190BM

alicate de corte frontal, semi raso  
punhos bi-material



ISO 9654

L mm	L1 mm	A mm	Cu mm	€	🔧	📦
120	12	12	1,25	55,50	2	011900113

### 1191BM

alicate de corte frontal oblíquo, raso  
punhos bi-material



ISO 9654

L mm	L1 mm	A mm	Cu mm	€	🔧	📦
130	8	12	0,8	55,50	2	011910101

### 1191BM/L

alicate de corte frontal oblíquo longo, raso  
punhos bi-material



ISO 9654

L mm	L1 mm	A mm	Cu mm	€	🔧	📦
130	18	12	1	55,50	2	011910110

### 1191R/5-M

kit de molas de substituição para alicates e  
pinças  
para componentes eletrônicos, 5 pares  
(artigos: 1171...1191)

Artigo	€	🔧	📦
1191R/5-M	10,90	1	011910995

### 1200MS

magnetizador/desmagnetizador

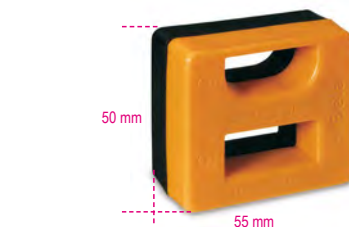

Artigo	€	🔧	📦
1200MS	17,30	5	012000000

# Beta **evox**

## A EVOLUÇÃO DA CHAVE DE FENDAS!

O desenho ergonómico adapta-se perfeitamente à palma da mão. A grande superfície de contacto permite transmitir a máxima força com esforço mínimo.

As hastes testadas da Beta garantem uma elasticidade, dureza e resistência ao desgaste únicas, para ferramentas profissionais topo de gama.

A secção octogonal impede que a chave role na bancada de trabalho.

A área de precisão permite que a chave de fendas seja rapidamente rodada entre os dedos.

O furo no cabo permite que a chave de fendas seja pendurada para fácil armazenamento. A nova borracha termoplástica torna cada utilização - mesmo em trabalhos pesados - ainda mais confortável.

A forma e o tamanho da ponta são impressos no cabo para uma identificação rápida.

As hastes testadas da Beta garantem uma elasticidade, dureza e resistência ao desgaste únicas, para ferramentas profissionais topo de gama.

O **desenho ergonómico** adapta-se perfeitamente à palma da mão. A grande superfície de contacto permite transmitir a máxima força com esforço mínimo.

A **secção octogonal** impede que a chave role na bancada de trabalho.

A área de precisão permite que a chave de fendas seja rapidamente rodada entre os dedos.

A nova borracha termoplástica torna cada utilização - mesmo em trabalhos pesados - ainda mais confortável.



A forma e o tamanho da ponta são impressos no cabo para uma identificação rápida.

O **BBO** furo no cabo permite que a chave de fendas seja pendurada para fácil armazenamento.

### 1201E

chaves para parafusos de perfil de fenda



ISO 2380

SxAxL mm	L1 mm	Ø mm	€	🔧	📦
0,4x2,5x50	146	2,5	4,30	5	012011003
0,4x2,5x75	166	2,5	4,45	5	012011006
0,5x3x75	171	3,0	4,50	5	012011009
0,5x3x100	196	3,0	4,85	5	012011012
0,6x3,5x75	171	3,5	4,85	5	012011018
0,6x3,5x100	196	3,5	4,95	5	012011021
0,8x4x100	196	4,0	5,10	5	012011030
0,8x4x125	221	4,0	5,40	5	012011033
0,8x4x150	246	4,0	5,80	5	012011036
1,0x5,5x100	209	5,0	6,40	5	012011039
1,0x5,5x125	234	5,0	6,70	5	012011040
1,0x5,5x150	259	5,0	6,80	5	012011042
1,2x6,5x100	220	6,0	7,50	5	012011048
1,2x6,5x125	234	6,0	7,80	5	012011050
1,2x6,5x150	270	6,0	8,00	5	012011051
1,2x8x150	282	8,0	10,20	3	012011057
1,2x8x200	332	8,0	11,00	3	012011060
1,6x10x200	332	9,5	12,80	3	012011066



1201E/S6	€	🔧	📦
0,5x3x75-0,6x3,5x100 0,8x4x100-1,0x5,5x100 1,2x8x150-1,6x10x200 mm	43,50	1	012011206

### 1201EN

chave para parafusos de perfil de fenda, série extra curta



ISO 2380

SxAxL mm	L1 mm	Ø mm	€	🔧	📦
0,8x4x30	86,5	4	6,20	3	012011103
1,2x6,5x30	86,5	6	6,60	3	012011106

### 1201E/DZ

chave para parafusos de perfil Dzus®



L mm	L1 mm	€	🔧	📦
53	173	16,10	2	012011501



## 1202E

chave para parafusos de perfil Phillips®



UNI-HISO 8764

PHxDxL mm	L1 mm	€	🔧	📦
0x3x60	156	4,45	5	012021003
0x3x100	200	4,95	5	012021006
1x4,5x80	189	5,70	5	012021009
1x4,5x120	229	6,50	5	012021012
2x6x100	220	7,80	5	012021018
2x6x150	270	8,40	5	012021021
3x8x150	282	10,70	3	012021024
4x9,5x200	332	14,00	3	012021027



1202E/S4	€	🔧	📦
PH0x3x60-PH1x4,5x120 PH2x6x150-PH3x8x150 mm	30,00	1	012021204

## 1202EN

chave para parafusos de perfil Phillips®, série extra curta



UNI-HISO 8764

PHxDxL mm	L1 mm	€	🔧	📦
1x4,5x30	86,5	6,20	3	012021103
2x6x30	86,5	6,60	3	012021106

## 1202EL

chave para parafusos de perfil Phillips®, série longa



UNI-HISO 8764-1

PHxDxL mm	L1 mm	€	🔧	📦
0x3x300	400	8,00	3	012021303
1x4,5x300	400	8,70	3	012021305
1x4,5x400	508	10,60	3	012021306
2x6x400	519	12,20	3	012021309

## 1203E/D

conjunto de chaves de parafuso



1203E/D5	€	🔧	📦
1201E 0,6x3,5x100-1,0x5,5x150 1,2x6,5x150 mm	33,00	1	012031001

1203E/D5PZ	€	🔧	📦
1201E 0,5x3x75-0,8x4x125 1,0x5,5x150 mm	32,00	1	012031003

1209E/PZ	€	🔧	📦
PZ1x4,5x80-PZ2x6x100 mm			

1203E/D6	€	🔧	📦
1202E PH1x4,5x80-PH2x6x100 mm	34,00	1	012031006

1204E	€	🔧	📦
0,4x2,5x60-0,5x3x100 0,8x4x100-1,0x5x125 mm			

1203E/D7	€	🔧	📦
1201E 0,5x3x75-0,8x4x100 1,0x5,5x100-1,2x6,5x150 mm	41,50	1	012031007

1202E	€	🔧	📦
PH0x3x60-PH1x4,5x80 PH2x6x100 mm			

1203E/D8	€	🔧	📦
1201E 0,5x3x75-0,8x4x125 1,0x5,5x150-1,2x6,5x150 mm	53,00	1	012031008

1202E	€	🔧	📦
PH0x3x60-PH1x4,5x80 PH2x6x100-PH3x8x150 mm			

1203E/D8P	€	🔧	📦
1201E 2,5x50-3x75-4x100 5,5x100-6,5x150 mm	46,00	1	012031018

1202E	€	🔧	📦
PH0x60-PH1x80-PH2x100 mm			

1203E/D10	€	🔧	📦
1201E 0,4x2,5x50-0,5x3x75 0,8x4x100-1,0x5,5x100	67,00	1	012031010

1202E	€	🔧	📦
1,2x6,5x150-1,2x8x150 mm PH0x3x60-PH1x4,5x80 PH2x6x100-PH3x8x150 mm			

1203E/D10N	€	🔧	📦
1201E 0,4x2,5x50-0,5x3x75-0,8x4x100- 1,0x5,5x150-1,2x6,5x150 mm	58,50	1	012031019

1201EN	€	🔧	📦
0,8x4x30 mm			
1202E	€	🔧	📦
PH0x3x60 - PH1x4,5x80 - PH2x6x100 mm			
1202EN	€	🔧	📦
PH1x4,5x30 mm			



## 1203E/S

Beta EVOLX



1203E/S8	€	🔧	📦
1201E 2,5x50-3x75-4x100 5,5x125-6,5x150 mm	46,00	1	012031009

1202E	€	🔧	📦
PH0x3x60-PH1x4,5x80 PH2x6x100 mm			

1203E/S10	€	🔧	📦
1201E 0,4x2,5x50-0,5x3x75 0,8x4x125-1,0x5,5x150	67,50	1	012031021

1202E	€	🔧	📦
1,2x6,5x150-1,2x8x150 mm PH0x3x60-PH1x4,5x80 PH2x6x100-PH3x8x150 mm			

## 1204E

chave para parafusos de perfil de fenda sem cabeça



ISO 2380

SxDxL mm	L1 mm	€	🔧	📦
0,4x2,5x60	156	4,40	5	012041003
0,6x3x75	175	4,50	5	012041006
0,5x3x100	196	4,60	5	012041009
0,8x4x100	196	5,20	5	012041012
0,8x4x125	233	5,50	5	012041015
1x5x125	234	6,40	5	012041018
1x5x150	258	6,90	5	012041021
1,2x6,5x150	270	7,50	5	012041024

Beta EVOLX



1204E/S5	€	🔧	📦
0,4x2,5x60-0,5x3x100 0,8x4x100-1x5x125 1,2x6,5x150 mm	28,00	1	012041205

## 1204EL

chave para parafusos de perfil de fenda sem cabeça, série longa



ISO 2380

SxDxL mm	L1 mm	€	🛒	📦
0,5x2,5x200	300	6,60	3	012041303
0,5x3x300	400	7,80	3	012041306
0,8x4x400	508	9,60	3	012041309
1x5x400	508	10,20	3	012041315
1,2x6,5x400	519	13,10	3	012041318

## 1205E/ES

chaves sextavadas com punho



mm	L mm	L1 mm	€	🛒	📦
1,5	100	200	5,60	3	012051315
2	100	200	5,70	3	012051320
2,5	100	200	5,80	3	012051325
3	100	200	6,00	3	012051330
4	100	208	6,90	3	012051340
5	100	219	8,20	3	012051350
6	125	244	8,40	3	012051360
8	150	277	11,20	2	012051380



1205E/ES-S8 € 57,50 1 012051408  
1,5-2-2,5-3-4-5-6-8 mm

## 1206E/BP

chaves sextavadas macho com extremidade esférica e punho



mm	L mm	L1 mm	Ø mm	€	🛒	📦
2	100	198	2,5	6,30	3	012061320
2,5	100	198	3,0	6,40	3	012061325
3	100	198	3,5	6,50	3	012061330
4	100	209	5,0	7,20	3	012061340
5	100	220	6,0	8,70	3	012061350
6	125	245	7,0	8,90	3	012061360
8	150	287	9,5	11,90	2	012061380



1206E/BP-S7 € 55,50 1 012061407  
2-2,5-3-4-5-6-8 mm

## 1207E/TX

chaves para parafusos de perfil Torx®, com punho



	L mm	L1 mm	Ø mm	€	🛒	📦
T5	50	150	3	6,70	5	012071005
T6	60	156	4	7,10	5	012071006
T7	60	156	4	7,20	5	012071007
T8	60	156	4	7,30	5	012071008
T9	60	156	4	7,70	5	012071009
T10	80	189	5	8,70	5	012071010
T15	80	189	5	8,80	5	012071015
T20	100	209	5	8,90	5	012071020
T25	100	209	5	9,20	5	012071025
T27	100	220	6	9,80	5	012071027
T30	100	220	6	9,90	5	012071030
T40	130	262	7	11,70	2	012071040
T45	130	262	8	12,90	2	012071045



1207E/TX-D7 € 59,50 1 012071207  
T6-T8-T10-T15

1207E/TX-S13 € 116,00 1 012071213  
T5-T6-T7-T8-T9-T10-T15  
T20-T25-T27-T30-T40-T45

## 1208E/RTX

chaves para parafusos de perfil Tamper Resistant Torx®, com punho



⊕	L mm	L1 mm	Ø mm	€	🛒	📦
T9	60	156	4	7,80	5	012081009
T10	80	189	5	8,70	5	012081010
T15	80	189	5	9,20	5	012081015
T20	100	209	5	9,40	5	012081020
T25	100	209	5	9,60	5	012081025
T27	100	220	6	10,40	5	012081027
T30	100	220	6	10,90	5	012081030
T40	130	262	7	13,00	2	012081040



1208E/RTX-D7 € 66,00 1 012081207  
T9-T10-T15-T20  
T25-T27-T30

## 1209E/PZ

chave para parafusos de perfil Pozidriv®-Supadriv®



UNI-ISO 8764

PZ	L mm	L1 mm	€	🛒	📦
0	60	156	5,20	5	012091000
1	80	189	6,80	5	012091003
2	100	220	8,70	5	012091006
3	150	282	13,30	3	012091009
4	200	327	14,50	3	012091012



1209E/PZ-S4 € 33,50 1 012091204  
PZ0-PZ1-PZ2-PZ3

## 1209EN/PZ

chave para parafusos de perfil Pozidriv®-Supadriv®, série extra curta



ISO 8764

PZ	L mm	L1 mm	€	🛒	📦
1	30	87	6,20	3	012091103
2	30	87	6,60	3	012091106



## CHAVE DE FENDAS ELÉTRICA BETA EVOX-E

A chave de fendas elétrica Beta Evox-E é ideal para realizar trabalhos de alta precisão com o mínimo esforço e máxima rapidez.



### CONFORTÁVEL

Dimensões reduzidas para utilização em espaços pequenos e LEDs frontais para excelente visibilidade do ponto de trabalho.

### DESIGN ERGONÓMICO

O punho adapta-se perfeitamente à palma da mão, para um trabalho firme e confortável.

1/4



USB-C

#### Vida útil da bateria

Bateria de lítio de longa duração de 3,7V 2300mAh, permitindo apertar até 1.000 parafusos com um ciclo de carga.

Está disponível em duas variantes:

- chave de fendas elétrica 1210E/GE com pontas



- chave de fendas elétrica 1211E/GE com pontas isoladas de 1000V



⚡ 1000 V



### 1210E/GE

chave de fendas Evox-E elétrica

- 4-5 mm
- ⊕ PH2
- ⊕ PZ2
- ⊛ T25 - T30



L mm 150 € 183,00 1 0121100701

### 1211E/GE

chave de fendas Evox-E elétrica

- 3,5x0,6 - 5,5x1 mm
- ⊕ PH2
- ⊕ PZ2
- ⊕ PH2/SL
- ⊕ PZ2/SL



L mm 150 € 194,00 1 012110701

### 1229LP/S



1229LP/A6 € 28,00 1 012290300  
1,2-1,4-1,8-2-2,4-3 mm

### 1229LPH/A6

jogo de 6 chaves de relojheiro 1229LP-1229PH



1229LPH/A6 € 28,00 1 012290310  
1229LP 1,4-2,0-2,4-3 mm  
1229PH PH0-PH1



## 1236B

chave de parafusos angular para parafusos de perfil de fenda

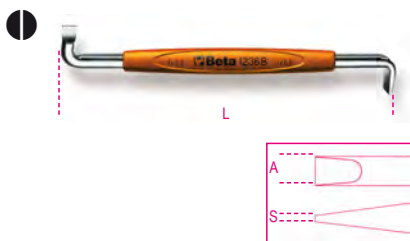

UNI 7079 DIN 5200

SxA mm	L mm	€		
0,8x4	100	8,00	5	012360201
1x5,5	125	9,30	5	012360202
1,2x8	150	11,50	5	012360204

## 1238B

chave de parafusos angular para parafusos de perfil Phillips®



UNI 7083 DIN 5208

PH	L mm	€		
1-2	125	9,50	5	012380201
3-4	200	15,40	5	012380203

## 1241

chave de parafusos com ponta de aço para parafusos de perfil de fenda

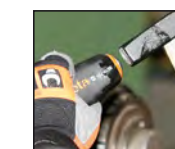

ISO 2380

SxAxL mm	L1 mm	€		
1x5,5x100	202	12,50	5	012410039
1,2x6,5x125	240	13,80	5	012410050
1,2x8x150	268	16,80	3	012410057
1,6x10x175	300	21,00	2	012410065
1,6x10x200	325	21,50	2	012410066
2,0x12x200	325	22,60	2	012410067
2,5x14x250	375	24,80	2	012410076

## 1242

chave de parafusos com ponta de aço para parafusos com perfil Phillips®



UNI/ISO 8764

PHxDxL mm	L1 mm	€		
1x4,5x100	202	12,30	5	012420209
2x6x100	215	14,50	5	012420218
3x8x150	268	18,60	3	012420221
4x11x200	325	24,10	2	012420224

## 1243LP/D6

jogo 6 chaves de fendas com cabeça em aço, para parafusos de cabeça ranhurada



	€		
1243LP/D6	112,00	1	012430016
1241			

## 1243/D7

Jogo de 7 chaves de parafusos com ponta de aço



	€		
1243/D7	110,00	1	012430017
1241			

## 1243/S11

jogo 11 chaves de fendas com cabeça em aço



	€		
1243/S11	202,00	1	012430021
1241			

## 1250

chaves de fenda com guia prensili

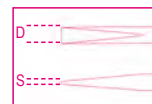

SxDxL mm	L1 mm	€		
0,5x3x125	190	17,70	5	012500030
0,6x4x125	225	19,10	5	012500040
0,7x5x150	255	22,50	5	012500050

## 1251

chaves para parafusos de perfil Phillips® com guia prensili



PHxDxL mm	L1 mm	€		
0x4x125	225	19,90	5	012510000
1x5x125	225	23,00	5	012510010
2x6x175	280	26,50	5	012510020

## 1252/S5



	€		
1252/S5	109,00	1	012520001
1250			



## 1253

busca-pólos 150/250V

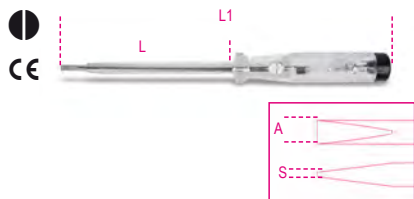

SxAxL mm	L1 mm	€	5	012530001
0,5x3,5x100	190	11,30		

## 1253A

busca-pólos 125/250V,  
duplo isolamento



SxAxL mm	L1 mm	€	5	012530010
0,5x3x15	150	8,00		

## 1254

busca-pólos 6/24V

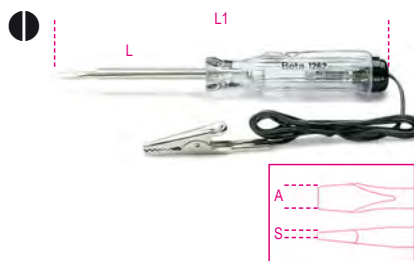

SxAxL mm	L1 mm	€	5	012540001
0,5x3x44	123	12,40		

## 1256/C36-2

punho para micro-chaves com 36 pontas  
intermutáveis de 4 mm e extensão magnética



1256/C36-2	€	5	012560100
	75,00		

	1256TX	T3 - T4 - T5 - T6 - T7 T8 - T9 - T10 - T15
	1256RTX	T6 - T7 - T8 - T9 - T10
	1256LP	0,8 - 1,2 - 1,5 - 1,8 - 2 - 2,5 3 - 3,5 - 4 mm
	1256PE	0,7 - 0,9 - 1,3 - 1,5 - 2 mm
	1256PH	PH000 - PH00 - PH0 - PH1
	1256PZ	PZ000 - PZ00 - PZ0 - PZ1
	1256/20	
	1256/30	
130x60x35 mm - 200 g		



## 1256LP

bits 4 mm  
para parafusos ranhurados

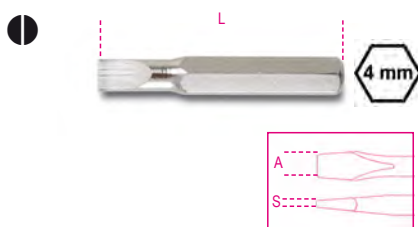

SxA	L	€	5	012560001
0,25x0,8	27	1,46		
0,25x1,2	27	1,46		
0,3x1,5	27	1,46		
0,35x1,8	27	1,46		
0,4x2,0	27	1,46		
0,4x2,5	27	1,46		
0,5x3,0	27	1,46		
0,6x3,5	27	1,46		
0,8x4,0	27	1,46		

## 1256PH

bits 4 mm  
para parafusos Phillips®



PH	L	€	5	012560011
000	27	1,46		
00	27	1,46		
0	27	1,46		
1	27	1,46		

## 1256PZ

bits 4 mm  
para parafusos de cabeça ranhurada Pozidriv®  
- Supradriv®



PZ	L	€	5	012560061
000	27	1,46		
00	27	1,46		
0	27	1,46		
1	27	1,46		

## 1256PE

bits 4 mm  
para parafusos sextavados



mm	L	€	5	012560021
0,7	27	1,46		
0,9	27	1,46		
1,3	27	1,46		
1,5	27	1,46		
2,0	27	1,46		

## 1256TX

bits 4 mm  
para parafusos Torx®



T	L	€	5	012560041
T3	27	1,52		
T4	27	1,52		
T5	27	1,52		
T6	27	1,52		
T7	27	1,52		
T8	27	1,52		
T9	27	1,52		
T10	27	1,52		
T15	27	1,52		

## 1256RTX

bits 4 mm  
para parafusos invioláveis "Tamper Resistant  
Torx®"



T	L	€	5	012560051
T6	27	1,82		
T7	27	1,82		
T8	27	1,82		
T9	27	1,82		
T10	27	1,82		

## 1256/20

extensão sextavada, 4 mm



1256/20	€	5	012560092
	9,20		

## 1256/30

porta-bits 4 mm com punho



L	€	5	012560097
110	10,90		

## 1257LP

micro-chaves para parafusos de perfil de fenda



SxD mm	L mm	€	U	IT
0,25x1,2	60	5,80	5	012570012
0,23x1,5	60	5,80	5	012570015
0,3x1,8	60	5,80	5	012570018
0,4x2	60	5,80	5	012570020
0,4x2,5	60	5,80	5	012570024
0,5x3	60	5,80	5	012570030
0,6x3,5	60	5,80	5	012570035
0,8x4	60	5,80	5	012570040



1257LP/S8	€	U	IT
0,2x1,2-0,25x1,5 0,3x1,8-0,4x2-0,4x2,5 0,5x3-0,6x3,5-0,8x4 mm	73,00	1	012570200

## 1257PH

micro-chaves para parafusos de perfil Philips®



PH	L mm	€	U	IT
00	60	5,80	5	012570060
0	60	5,80	5	012570063
1	60	5,80	5	012570066



## 1257LPH/S8

Jogo de 8 micro-chaves (refa. 1257LP, 1257PH) em caixa



1257LPH/S8	€	U	IT
1257PH PH00-PH0-PH1 1257LP 0,4x2-0,4x2,5-0,5x3 0,6x3,5-0,8x4 mm	73,00	1	012570210

## 1257ES

micro-chaves com ponta macho hexagonal



mm	L mm	€	U	IT
0,9	60	6,60	5	012570045
1,3	60	6,60	5	012570046
1,5	60	6,60	5	012570047
2	60	6,60	5	012570048
2,5	60	6,60	5	012570049
3	60	6,60	5	012570050

## 1257ESB/S8



1257ESB/S8	€	U	IT
1257ES 0,9-1,3-1,5-2-2,5-3 mm 1257BE 4-5 mm	83,00	1	012570230

## 1257TX

micro-chaves para parafusos de perfil Torx®



mm	L mm	€	U	IT
T5	60	6,90	5	012570075
T6	60	6,90	5	012570076
T7	60	6,90	5	012570077
T8	60	6,90	5	012570078
T9	60	6,90	5	012570079
T10	60	6,90	5	012570080
T15	60	6,90	5	012570081
T20	60	6,90	5	012570082



1257TX/S8	€	U	IT
T5-T6-T7-T8 T9-T10-T15-T20	81,50	1	012570220

## 1257BE

micro-chave de fenda para parafusos macho sextavados



mm	L mm	€	U	IT
3,2	60	8,60	5	012570085
4	60	8,60	5	012570086
5	60	8,60	5	012570087
5,5	60	8,60	5	012570088







As chaves BetaGrip são fruto da longa experiência da Beta no design de chaves de fendas e da estreita colaboração com mecânicos de equipas de automobilismo.

Novas e exclusivas soluções técnicas, capazes de satisfazer os requisitos dos profissionais mais exigentes, foram utilizadas com o objetivo de alcançar os mais altos padrões de ergonomia, robustez e qualidade dos materiais.

- A haste é fabricada em aço especial com elevado teor de silicone, cromo e vanádio, para garantir uma excelente performance em termos de força de torção e flexibilidade. O acabamento escolhido foi um revestimento cromado mate.
- A geometria da ponta foi concebida para assegurar um encaixe perfeito entre a haste e a cabeça do parafuso. O acabamento com revestimento de fosfato previne a oxidação da ponta, mantendo simultaneamente perfis perfeitos.
- A textura foi buscar inspiração aos rastros dos pneus de Corrida, desenvolvidos para maximizar a aderência em diferentes pavimentos. Garante assim uma retenção eficiente da chave de fendas em quaisquer condições de trabalho, para maior precisão e controlo ao encaixar a ponta no parafuso.



## 1260

chaves para parafusos de perfil de fenda



ISO 2380

SxAxL mm	L1 mm	Ø mm	€	🔧	📦
0,4x2,5x50	150	2,5	6,00	5	012600003
0,4x2,5x75	175	2,5	6,30	5	012600006
0,5x3x75	175	3,0	6,40	5	012600009
0,5x3x100	200	3,0	6,60	5	012600012
0,6x3,5x75	175	3,5	6,80	5	012600018
0,6x3,5x100	200	3,5	6,90	5	012600021
0,8x4x100	208	4,0	7,50	5	012600030
0,8x4x125	233	4,0	7,90	5	012600033
0,8x4x150	258	4,0	8,20	5	012600036
1x5,5x100	208	5,0	8,60	5	012600039
1x5,5x125	233	5,0	8,80	5	012600040
1x5,5x150	258	5,0	9,60	5	012600042
1,2x6,5x100	219	6,0	10,40	5	012600048
1,2x6,5x125	244	6,0	10,80	5	012600050
1,2x6,5x150	269	6,0	11,20	5	012600051
1,2x8x150	277	8,0	13,70	3	012600057
1,2x8x200	327	8,0	14,10	3	012600060
1,6x10x200	327	9,5	17,10	3	012600066
2x12x250	377	10	20,30	3	012600069
2x14x250	377	10	21,50	2	012600073



1260/S6	€	🔧	📦
0,4x2,5x75-0,5x3x75-0,8x4x125 1x5,5x150-1,2x6,5x150-1,2x8x200 mm	55,50	1	012600306

## 1260N

chaves para parafusos de perfil de fenda, série extra curta



ISO 2380

SxAxL mm	L1 mm	Ø mm	€	🔧	📦
0,8x4x30	87	4	8,00	5	012600103
1,2x6,5x30	87	6	8,80	5	012600106



## 1260E

chaves para parafusos de perfil de fenda com sextavado auxiliar



ISO 2380

SxAxL mm	L1 mm	Ø mm	€		
1,2x6,5x150	269	6,0	14,50	3	012600156
1,2x8x175	301	8,0	17,80	3	012600157
1,6x10x200	327	9,5	20,60	2	012600159
2x12x250	377	9,5	23,90	2	012600162

## 1260MC

chaves para parafusos de perfil de fenda, coloridas



SxAxL mm	L1 mm	Ø mm	€		
0,4x2,5x50	150	2,5	6,50	3	012602003
0,6x3,5x75	175	3,5	6,70	3	012602018
0,8x4x100	208	4,0	8,00	3	012602030
1x5,5x150	233	5,0	10,20	5	012602040
1,2x6,5x150	269	6,0	11,70	5	012602051

## 1262

chaves para parafusos de perfil Phillips(R)



UNI/ISO 8764

PHxDxL mm	L1 mm	€		
0x3x60	160	6,40	5	012620003
0x3x100	200	6,80	5	012620006
1x4,5x80	188	8,40	5	012620009
1x4,5x120	228	9,10	5	012620012
2x6x100	219	10,30	5	012620018
2x6x150	269	11,30	5	012620021
3x8x150	277	15,20	3	012620024
4x10x200	327	19,30	3	012620027



1262/S4	€		
PH0x3x60-PH1x4,5x80 PH2x6x100-PH3x8x150 mm	40,00	1	012620304

## 1262N

chaves para parafusos de perfil Phillips®, série extra curta



UNI/ISO 8764

PHxDxL mm	L1 mm	€		
1x4,5x30	87	8,00	5	012620103
2x6x30	87	8,80	5	012620106

## 1262E

chaves para parafusos de perfil Phillips® com sextavado auxiliar



UNI/ISO 8764

PHxDxL mm	L1 mm	€		
2x6x150	269	14,50	3	012620153
3x8x175	302	17,60	3	012620156
4x10x200	327	22,20	2	012620159

## 1262L

chaves para parafusos de perfil Phillips®, série longa



UNI/ISO 8764-1

PHxDxL mm	L1 mm	€		
0x3x300	400	11,00	3	012620203
1x4,5x300	400	13,20	3	012620205
1x4,5x400	508	15,30	3	012620206
2x6x400	519	19,90	3	012620209

## 1262MC

chaves para parafusos de perfil Phillips®, coloridas



PHxDxL mm	L1 mm	€		
0x3x60	160	6,70	3	012622003
1x4,5x80	188	8,70	3	012622009
2x6x100	219	10,80	3	012622018

## 1263/D...

jogo de chaves de parafusos



1263/D6	€		
1260 0,5x3x75-0,8x4x100 1x5,5x125-1,2x6,5x150 mm	52,50	1	012630006
1262 PH1x4,5x80-PH2x6x100 mm			

1263/D7	€		
1262 PH0x3x60 PH1x4,5x80 PH2x6x100 mm	54,00	1	012630017
1264 0,5x2,5x60-0,6x3x100 0,8x4x125-1x5x125 mm			

1263/D7PZ	€		
1260 0,5x3x75-0,8x4x100 1x5,5x150-1,2x6,5x150 mm	63,00	1	012630007
1269PZ PZ0 - PZ1 - PZ2			

1263/D8	€		
1260 0,4x2,5x50-0,5x3x75 0,8x4x100-1x5,5x125 1,2x6,5x150 mm	65,00	1	012630008
1262 PH0x3x60-PH1x4,5x80 PH2x6x100 mm			

1263/D10	€		
1260 0,5x3x75-0,6x3,5x100 0,8x4x125-1x5,5x150 1,2x6,5x150 mm	83,00	1	012630010
1260N 0,8x4x30			
1262 PH0x3x60-PH1x4,5x80 PH2x6x100 mm			
1262N PH1x4,5x30			



## 1263/S12

jogo de 12 chaves de parafusos



1263/S12 € 118,00 1 012630112

1260	0,4x2,5x50-0,5x3x75 0,6x3,5x100-0,8x4x125 1x5,5x125-1,2x6,5x150 1,2x8x200-1,6x10x200 mm
1262	PH0x3x60-PH1x4,5x80 PH2x6x100-PH3x8x150 mm

## 1263MC/D8

jogo de 8 chaves de parafusos coloridas



1263MC/D8 € 69,00 1 012632008

1260MC	0,4x2,5x50-0,5x3x75 0,8x4x100-1x5,5x125 1,2x6,5x150 mm
1262MC	PH0x3x60-PH1x4,5x80 PH2x6x100 mm

## 1264

jogo de chaves para parafusos de perfil de fenda sem cabeça



SxAxL mm	L1 mm	€	U	U
0,5x2,5x60	160	6,00	5	012640003
0,6x3x75	175	6,40	5	012640006
0,6x3x100	200	6,60	5	012640009
0,8x4x100	208	7,50	5	012640012
0,8x4x125	233	7,90	5	012640015
1x5x125	233	8,80	5	012640018
1x5x150	258	9,30	5	012640021
1,2x6,5x150	269	11,20	5	012640024



1264/S5 € 40,00 1 012640305

0,5x2,5x60-0,6x3x75 0,8x4x100-1x5x125-1,2x6,5x150 mm
---

## 1264L

jogo de chaves para parafusos de perfil de fenda sem cabeça, série longa



SxAxL mm	L1 mm	€	U	U
0,5x2,5x200	300	8,90	3	012640203
0,6x3x300	400	10,50	3	012640206
0,8x4x400	508	13,70	3	012640209
1x5x400	508	15,30	3	012640215
1,2x6,5x400	519	18,60	3	012640218

## 1265ES

chaves hexagonais com punhos



mm	L mm	L1 mm	€	U	U
1,5	100	200	7,30	3	012650015
2	100	200	7,50	3	012650020
2,5	100	200	7,80	3	012650025
3	100	200	8,20	3	012650030
4	100	208	9,00	3	012650040
5	100	219	10,40	3	012650050
6	125	244	11,70	3	012650060
8	150	277	15,60	2	012650080



1265ES/S8 € 77,50 1 012650308

1,5-2-2,5-3-4-5-6-8 mm
------------------------

## 1266BP

chaves hexagonais de extremidade esférica com punhos



mm	L mm	L1 mm	€	U	U
2	100	200	8,00	3	012660020
2,5	100	200	8,30	3	012660025
3	125	225	8,60	3	012660030
4	125	233	9,60	3	012660040
5	120	239	11,20	3	012660050
6	140	259	13,00	3	012660060
8	160	287	16,30	2	012660080
10	160	287	19,60	2	012660100



1266BP/S8 € 94,50 1 012660308

2-2,5-3-4-5-6-8-10 mm
-----------------------

## 1267TX

chaves para parafusos de perfil Torx®, com punhos



mm	L mm	L1 mm	Ø mm	€	U	U
T5	50	150	3	8,90	5	012670005
T6	50	150	3	9,30	5	012670006
T7	50	150	3	9,60	5	012670007
T8	60	160	3	10,10	5	012670008
T9	60	167	4	10,50	5	012670009
T10	80	188	4	10,90	5	012670010
T15	80	188	4	11,50	5	012670015
T20	100	208	4,5	12,20	5	012670020
T25	100	208	5	13,20	5	012670025
T27	115	234	6	13,70	5	012670027
T30	115	234	6	14,40	5	012670030
T40	130	257	7	16,70	2	012670040
T45	130	257	8	18,40	2	012670045







**1267TX/D7**  
T6-T8-T10-T15  
T20-T25-T30

€ 81,50 1 012670307



**1267TX/S13**  
T5-T6-T7-T8-T9  
T10-T15-T20-T25  
T27-T30-T40-T45

€ 159,00 1 012670312

### 1267MC/TX

chaves para parafusos de perfil Torx®, com punhos, coloridas



Ø	L mm	L1 mm	Ø mm	€	Unid.	Art.
T6	50	150	3	9,80	5	012672006
T8	60	160	3	10,40	5	012672008
T10	80	188	4	11,40	5	012672010
T15	80	188	4	12,20	5	012672015
T20	100	208	4,5	13,00	5	012672020
T25	100	208	5	13,60	3	012672025
T30	115	234	6	14,90	3	012672030



**1267MC/TX-D7**  
T6-T8-T10-T15  
T20-T25-T30

€ 85,00 1 012672307

### 1268RTX

chaves para parafusos de perfil Tamper Resistant Torx®, com punhos



Ø	L mm	L1 mm	Ø mm	€	Unid.	Art.
T9	60	167	4,0	11,40	3	012680009
T10	80	188	4,0	11,80	3	012680010
T15	80	188	4,0	12,20	3	012680015
T20	100	208	4,5	13,20	3	012680020
T25	100	208	5,0	13,50	3	012680025
T27	115	234	6,0	14,40	3	012680027
T30	115	234	6,0	14,60	3	012680030
T40	130	257	7,0	16,90	2	012680040



**1268RTX/S8**  
T9-T10-T15-T20  
T25-T27-T30-T40

€ 108,00 1 012680307

### 1269PZ

chaves para parafusos de perfil Pozidriv®-Supadriv®



UNI/ISO 8764

PZ	L mm	L1 mm	€	Unid.	Art.
0	60	160	7,30	5	012690000
1	80	188	9,50	5	012690001
2	100	219	11,40	5	012690002
3	150	277	16,30	3	012690003
4	200	327	20,80	3	012690004



**1269PZ/S4**  
PZ0-PZ1-PZ2-PZ3

€ 44,50 1 012690304

### 1269N/PZ

chaves para parafusos de perfil Pozidriv®-Supadriv®, série extra curta



UNI/ISO 8764

PZ	L mm	L1 mm	€	Unid.	Art.
1	30	87	8,00	5	012690011
2	30	87	8,80	5	012690012

### 1281BG

punho para chave de parafusos de lâmina intermutável



L mm	Ø mm	€	Unid.	Art.
118	10	13,40	5	012810280

### 1281PM

porta-pontas magnético de fixação rápida



L mm	€	Unid.	Art.
165	22,80	5	012810292

### 1281PB

porta-chaves de caixa com quadra macho 1/4"



L mm	€	Unid.	Art.
175	18,30	5	012810293

### 1281LP

lâmina reversível intermutável para parafusos de perfil de fenda



Art.	€	Unid.	Art.
1281LP/1	11,70	5	012810302
0,8x4-1,2x6,5 mm			
1281LP/2	11,70	5	012810304
1x5,5-1,2x6,5 mm			

## 1281PH

lâmina reversível intermutável  
para parafusos de perfil Phillips®



PH	€	5	012810310
1-2	11,70		
2-3	11,70		012810312

## 1281LPH

lâmina reversível intermutável  
para parafusos de perfil Phillips® e fenda



	€	5	012810321
1281LPH/1 PH0-0,8x4 mm	11,70		
1281LPH/2 PH1-1x5,5 mm	11,70		012810322
1281LPH/3 PH2-1,2x6,5 mm	11,70		012810323

## 1281PZ

lâmina reversível intermutável  
para parafusos de perfil Pozidriv®-Supadriv®



PZ	€	5	012810330
1-2	11,70		
2-3	11,70		012810332

## 1281PE

lâmina reversível intermutável  
hexagonal macho, esférica



mm	€	5	012810342
2,5	11,50		
3	11,50		012810343
4	11,50		012810344
5	11,50		012810345
6	11,50		012810346

## 1281TX

lâmina reversível intermutável  
para parafusos de perfil Torx®

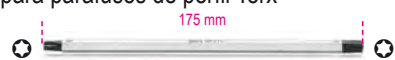

	€	5	012810349
1281TX/1 T6-T8	12,90		
1281TX/2 T7-T9	12,90		012810350
1281TX/3 T10-T15	12,90		012810351
1281TX/4 T20-T25	12,90		012810352
1281TX/5 T30-T40	12,90		012810353

## 1281RTX

lâmina reversível intermutável  
para parafusos de perfil Tamper Resistant  
Torx®



	€	5	012810361
1281RTX/3 T10-T15	13,10		
1281RTX/4 T20-T25	13,10		012810362
1281RTX/5 T30-T40	13,10		012810363

## 1281BG/A9

jogo 9 chaves reversíveis  
e 1 acessório em bolsa



1281BG/A9	€	1	012810520
-----------	---	---	-----------

1281BG	
1281LPH/1	PH0-0,8x4 mm
1281LPH/2	PH1-1x5,5 mm
1281LPH/3	PH2-1,2x6,5 mm
1281PZ/1	PZ1-PZ2
1281PE	2,5 mm
1281PE	3 mm
1281PE	4 mm
1281PE	5 mm
1281PE	6 mm

## 1281BG-TX/A8

jogo 8 chaves reversíveis  
e 1 acessório em bolsa



1281BG-TX/A8	€	1	012810530
--------------	---	---	-----------

1281BG	
1281LPH/1	PH0-0,8x4 mm
1281LPH/2	PH1-1x5,5 mm
1281LPH/3	PH2-1,2x6,5 mm
1281TX/1	T6-T8
1281TX/2	T7-T9
1281TX/3	T10-T15
1281TX/4	T20-T25
1281TX/5	T30-T40

## 1281BG/B28NA

sortido de 16 chaves para parafusos  
reversíveis, 9 chaves de caixa 1/4", 2  
acessórios e 1 punho, em bolsa de poliéster



1281BG/B28NA	€	1	012810511
--------------	---	---	-----------

900	
1281BG	4 - 4,5 - 5 - 5,5 6 - 7 - 8 - 9 - 10 mm
1281PB	1/4"
900/25	
1281LP/1	0,8x4 - 1,2x6,5 mm
1281LP/2	1,0x5,5 - 1,2x6,5 mm
1281PH/1	PH1 - PH2
1281PH/2	PH2 - PH3
1281PZ/1	PZ1 - PZ2
1281PZ/2	PZ2 - PZ3
1281PE	2,5 - 3 - 4 - 5 - 6 mm
1281TX/1	T6 - T8
1281TX/2	T7 - T9
1281RTX/3	T10 - T15
1281RTX/4	T20 - T25
1281RTX/5	T30 - T40

2002/BV7-ZIP	€	1	020020060
--------------	---	---	-----------



As **chaves de fendas BetaMax** possuem várias características técnicas que proporcionam ainda maior facilidade de trabalho.

- O punho, inspirado na secção triangular, assegura um trabalho excelente, com um alcance de 120°, em linha com a rotação máxima do pulso.
- O design confere extraordinárias propriedades em termos de ergonomia durante as operações de aparafusar com rapidez e de apertar.
- A ponta sem cromado e com revestimento de fosfato anti-oxidação, garante o encaixe perfeito com o parafuso.



## 1290

chaves para parafusos de perfil de fenda



ISO 2380

SxAxL mm	L1 mm	Ø mm	€		
0,4x2,5x50	146	2,5	7,70	5	012900003
0,4x2,5x75	171	2,5	8,00	5	012900006
0,5x3x75	171	3,0	8,10	10	012900009
0,5x3x100	196	3,0	8,50	10	012900012
0,6x3,5x75	171	3,5	9,20	10	012900018
0,6x3,5x100	196	3,5	9,40	10	012900021
0,8x4x100	196	4,0	9,50	10	012900030
0,8x4x125	221	4,0	9,70	10	012900033
0,8x4x150	246	4,0	10,40	10	012900036
1x5,5x100	209	5,0	10,60	10	012900039
1x5,5x150	259	5,0	11,70	10	012900042
1,2x6,5x100	220	6,0	13,20	10	012900048
1,2x6,5x150	270	6,0	13,90	10	012900051
1,2x8x150	282	7,0	17,40	3	012900057
1,2x8x200	332	7,0	18,50	3	012900060
1,6x10x200	332	8,0	21,70	3	012900066
2x12x250	382	10	29,00	2	012900069

## 1290/S

jogo de chaves de parafusos



1290/S5	€		
1290	61,00	1	012900305
1290 0,5x3x75-0,8x4x100 -1x5,5x150 1,2x6,5x150 -1,2x8x150 mm			
1290/S9X	€		
1290	114,00	1	012900319
1290 0,4x2,5x75 - 0,5x3,5x100 0,8x4x125 - 1x5,5x150 1,2x6,5x150 - 1,2x8x200 1,6x10x200 mm			
1290N			0,8x4x30 -1,2x6,5x30 mm

## 1290N

chaves série curta para parafusos de perfil de fenda



ISO 2380

SxAxL mm	L1 mm	Ø mm	€		
0,8x4x30	86	4	10,00	5	012900103
1,2x6,5x30	86	6	11,10	5	012900106

## 1292

chaves para parafusos de perfil Phillips®



UNI/ISO 8764

PHxDxL mm	L1 mm	€		
0x3x60	156	7,30	10	012920003
0x3x100	196	8,40	5	012920006
1x4,5x80	189	10,10	10	012920009
1x4,5x120	229	11,20	10	012920012
2x6x100	220	13,40	10	012920018
2x6x150	270	14,30	10	012920021
3x8x150	282	18,30	3	012920024
4x10x200	332	25,00	3	012920027



1292/S4	€		
PH0x3x60-PH1x4,5x80 PH2x6x100-PH3x8x150 mm	48,50	1	012920304

## 1292N

chaves série curta para parafusos de perfil Phillips®



UNI/ISO 8764

PHxDxL mm	L1 mm	€		
1x4,5x30	86	9,60	5	012920103
2x6x30	86	10,50	5	012920106

## 1292L

chaves série longa para parafusos de perfil Phillips®

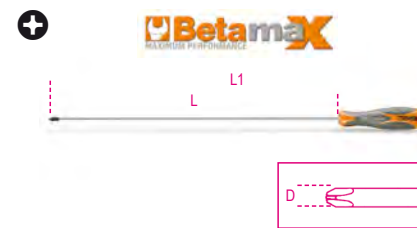

UNI/ISO 8764-1

PHxDxL mm	L1 mm	€		
0x3x300	396	16,30	3	012920203
1x4,5x400	509	20,10	3	012920206
2x6x400	520	24,70	3	012920209



## 1293/D...

jogo de chaves de parafusos

**Betamax**  
MAXIMUM PERFORMANCE



1293/D6 € 65,50 1 012930401

1290 0,6x3,5x75-1x5,5x150  
1,2x6,5x150 mm  
1292 PH0x3x60 -PH1x4,5x80  
PH2x6x100 mm

1293/D8 € 91,50 1 012930403

1290 0,5x3x75-0,8x4x100  
1x5,5x150-1,2x6,5x150  
1,2x8x150 mm  
1292 PH0x3x60 -PH1x4,5x80  
PH2x6x100 mm

## 1293/S...

jogo de chaves de parafusos

**Betamax**  
MAXIMUM PERFORMANCE



1293/S8 € 81,50 1 012930208

1290 2,5x50-3x75-4x100-5,5x150  
6,5x150 mm  
1292 PH0x3x60 -PH1x4,5x80  
PH2x6x100 mm

1293/S10 € 130,00 1 012930201

1290 0,4x2,5x50 -0,6x3,5x100  
1x5,5x100-1,2x6,5x150  
1,2x8x150-1,6x10x200 mm  
1292 PH0x3x60 -PH1x4,5x80  
PH2x6x100-PH3x8x150 mm

1293/S12 € 141,00 1 012930203

1290 0,5x3x75-0,8x4x125  
1x5,5x150-1,2x6,5x150  
1,2x8x200 mm  
1290N 0,8x4x30 mm  
1292 PH0x3x60 -PH1x4,5x80  
PH2x6x100-PH3x8x150 mm  
1292N PH1x4,5x30-PH2x6x30 mm

1293/S7 € 67,00 1 012930207

1292 PH0x3x60 -PH1x4,5x80  
PH2x6x100 mm  
1294 0,5x2,5x60-0,6x3x75  
0,8x4x100-1x5x125 mm

## 1293ES

chaves hexagonal macho com punho

**Betamax**  
MAXIMUM PERFORMANCE



mm	L mm	L1 mm	Ø mm	€	U	U
2	100	196	3	10,40	5	012930001
2,5	100	196	4	10,40	5	012930002
3	100	196	4	10,70	5	012930003
4	100	196	5	12,00	5	012930004
5	100	209	6	13,40	5	012930005
6	125	245	7	15,20	5	012930006
8	150	282	10	20,10	2	012930008



1293ES/S7 € 92,50 1 012930057

## 1293BP

chaves hexagonal macho com extremidade esférica e punho

**Betamax**  
MAXIMUM PERFORMANCE



mm	L mm	L1 mm	€	U	U
2	100	196	10,50	5	012930501
2,5	100	196	10,50	5	012930502
3	100	196	10,80	5	012930503
4	100	196	12,00	5	012930506
5	100	209	13,40	5	012930509
6	125	245	15,50	5	012930512
8	150	282	21,00	2	012930515



1293BP/S7 € 94,00 1 012930558

## 1294

chaves para parafusos de perfil de fenda sem cabeça

**Betamax**  
MAXIMUM PERFORMANCE

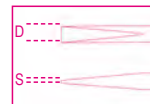

SxDxL mm	L1 mm	€	U	U
0,5x2,5x60	156	7,20	5	012940003
0,6x3x75	171	7,60	5	012940006
0,6x3x100	196	7,80	5	012940009
0,8x4x100	196	9,50	5	012940012
0,8x4x150	246	12,40	5	012940015
1x5x125	234	11,80	5	012940018
1,2x6,5x150	282	14,00	5	012940027



1294/S5 € 50,50 1 012940305

0,5x2,5x60-0,6x3x100  
0,8x4x100-1x5x125  
1,2x6,5x150 mm

## 1294L

chaves série longa para parafusos de perfil de fenda sem cabeça

**Betamax**  
MAXIMUM PERFORMANCE

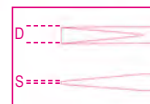

SxDxL mm	L1 mm	€	U	U
0,6x3x300	396	15,70	3	012940206
0,8x4x400	496	18,50	3	012940209
1x5x400	509	22,60	3	012940215
1,2x6,5x400	532	25,50	3	012940218

## 1295

desandador de percussão

12"

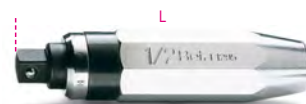

L mm 130 € 67,00 1 012950001



## 1295/C14

desandador de percussão com 14 pontas e 1 porta pontas



1295/C14 € 176,00 1 012950108

	866LP	1,2x6,5 - 1,6x10 mm
	866PH	PH2 - PH3
	866PZ	PZ2 - PZ3
	866PE	5 - 6 mm
	866TX	T27 - T30 - T40 - T45 - T50 - T55
	895/6	□ 1/2 - ○ 5/16
	1295	■ 1/2

170x100x35 mm - 1,3 kg

## 1297TX

chaves com punho para parafusos de perfil Torx®



Ø	L mm	L1 mm	Ø mm	€	U	1297TX
T6	50	146	3,0	13,60	5	012970006
T7	50	146	3,0	13,80	5	012970007
T8	60	156	3,0	13,90	5	012970008
T9	60	169	4,0	14,40	5	012970009
T10	80	189	4,0	15,40	5	012970010
T15	80	189	4,0	15,50	5	012970015
T20	100	209	4,5	15,90	5	012970020
T25	100	209	5,0	16,40	5	012970025
T27	115	235	6,0	16,90	5	012970027
T30	115	235	6,0	17,80	5	012970030
T40	130	262	7,0	19,80	2	012970040
T45	130	262	8,0	22,50	2	012970045



1297TX/S12 € 196,00 1 012970312  
T6-T7-T8-T9-T10  
T15-T20-T25-T27  
T30-T40-T45



## Betamax



1297TX/D6 € 98,00 1 012970409  
T10-T15-T20  
T25-T27-T30

## 1297TX/L

chaves com punho para parafusos de perfil Torx®, série longa



Ø	L mm	L1 mm	Ø mm	€	U	1297TX/L
T15	210	319	4,0	17,20	2	012970115
T20	210	319	4,5	17,70	2	012970120
T25	210	319	5,0	18,30	2	012970125
T30	210	330	6,0	19,60	2	012970130
T45	210	342	8,0	21,30	2	012970145



## Betamax



1297TX/L-S5 € 94,00 1 012970325  
TX/L15-TX/L20-TX/L25-  
TX/L30-TX/L45

## 1298RTX

chaves com punho para parafusos de perfil Tamper Resistant Torx®



Ø	L mm	L1 mm	Ø mm	€	U	1298RTX
T9	60	169	4,0	15,90	5	012980009
T10	80	189	4,0	16,20	5	012980010
T15	80	189	4,0	17,20	5	012980015
T20	100	209	4,0	17,30	5	012980020
T25	100	209	4,5	17,70	5	012980025
T27	115	235	5,5	19,10	5	012980027
T30	115	235	6,0	19,80	5	012980030
T40	130	262	7,0	21,30	2	012980040



## Betamax



1298RTX/S8 € 145,00 1 012980308  
T9-T10-T15-T20  
T25-T27-T30-T40

## 1299PZ

chaves para parafusos de perfil Pozidriv® - Supadriv®



UNI/ISO 8764

PZ	L mm	L1 mm	€	U	1299PZ
0	60	156	10,60	5	012990000
1	80	189	12,50	5	012990003
2	100	220	16,90	5	012990006
3	150	282	24,50	2	012990009
4	200	332	34,50	2	012990012



## Betamax



1299PZ/S6 € 89,50 1 012990306  
1299PZ PZ0-PZ1-PZ2-PZ3  
1299N/PZ PZ1-PZ2

## 1299N/PZ

chaves série curta para parafusos de perfil Pozidriv® - Supadriv®



UNI/ISO 8764

PZ	L mm	L1 mm	€	U	1299N/PZ
1	30	86	12,00	5	012990021
2	30	86	13,40	5	012990024





# REPARAÇÃO DE VEÍCULOS

As nossas ferramentas para reparação de veículos, usadas pelos profissionais mais exigentes, são desenvolvidas e fabricadas para cumprir as normas mais rígidas a nível mundial, e são testadas com regularidade sob as mais difíceis condições de trabalho.

Há mais de 50 anos que temos o orgulho de trabalhar de mãos dadas com os melhores, que nos ajudam a melhorar continuamente os nossos produtos e são testemunhas dos mais elevados padrões de qualidade.

**As ferramentas de reparação de veículos encontram-se nas seguintes secções:**

<b>Diagnóstico</b>	itens 1464T/N a 1465 itens 1498SM a 1499 itens 1758VT a 1760/IR 1600
<b>Motor</b>	itens 955 a 960SN itens 1440 a 1462/KEP itens 1472 a 1485TC itens 1737 a 1759TT
<b>Óleo e filtros</b>	itens 1488/1 a 1496/C itens 1877 a 1889N
<b>Sistema elétrico</b>	itens 1489/33 a 1489Y itens 1497D a 1497RC
<b>Arrancadores</b>	itens 1498BC/12 a 1498DG1100E
<b>Transmissão</b>	itens 1884 a 1885/X C60 itens 1438 a 1438DSG itens 1566N a 1569/F
<b>Suspensão</b>	itens 1550U a 1567
<b>Travões</b>	itens 1466/C5 a 1471T/C5
<b>Rodas</b>	itens 720MRC a 729T itens 962 a 989B itens 1530/C5 a 1531/C7
<b>Carroçaria</b>	itens 1065F5 a 1068 itens 1302 a 1369/C11 itens 1478 a 1479U/32 itens 1505V a 1539 itens 1763 a 1768
<b>Outros equipamentos</b>	itens 1875LT a 3067
<b>Elevação</b>	itens 3006 a 3069

## 1302

encontrador duplo com punho com almofada convexa e pena



g 770 € 109,00 1 013020001

## 1303

encontrador tipo virgula



g 1350 € 82,50 1 013030001

## 1304

encontrador tipo palmilha com entalhe



g 875 € 104,00 1 013040001

## 1305

encontrador curvo



g 1190 € 66,00 1 013050001

## 1305Z

encontrador curvo serrilhado

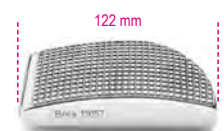

g 1065 € 78,00 1 013050002

## 1306

encontrador tipo tacão

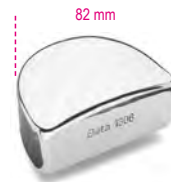

g 1040 € 62,00 1 013060001

## 1307

encontrador rectangular

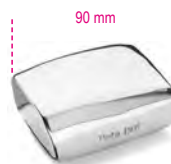

g 1100 € 121,00 1 013070001

## 1308

encontrador oval



g 1100 € 113,00 1 013080001

## 1310

encontrador tipo trilho



g 1225 € 70,00 1 013100001

## 1312

encontrador tipo bigorna



g 1220 € 150,00 1 013120001



### 1314

encontrador redondo duplo com almofadas convexa e plana



760 g € 66,50 1 013140001

### 1326

colher estreita simples



560 g € 59,50 1 013260001

### 1327

colher larga simples



1075 g € 83,00 1 013270001

### 1328

colher côncava simples



935 g € 75,50 1 013280001

### 1329

colher dupla com mesas largas



1800 g € 230,00 1 013290001

### 1330

colher dupla pescoço de cisne com mesas largas



2125 g € 245,00 1 013300001

### 1331

colher curva com face em coiro



1100 g € 136,00 1 013310001

### 1335BM

lima de bancada com punho plástico



500 g € 40,00 2 013350010

### 1337/S5

jogo de 5 espátulas para reparação auto, em aço inoxidável

Tipo Japonês (25-50-75-100-125 mm)



L mm € 15,30 1 013370015

### 1338A - 1338B

armações flexíveis com lima de chapeiro



1338A 9 360 mm € 113,00 2 013380001  
1338B 12 360 mm € 119,00 2 013380002

### 1338

armação para limas para refª. 1338R



1338 € 61,50 2 013380003

### 1338R9 - 1338R12

limas de substituição para refªs. 1338A-B



1338R9 9 51,50 2 013380004  
1338R12 12 57,50 2 013380005

### 1342

talheadeira extra-chata com lâmina direita



L mm € 35,50 5 013420001

### 1342PM

talheadeira chata com cortante direito com punho de protecção



L mm L1 mm € 50,50 2 013420002

### 1342PMR

punho de protecção para refª. 1342



1342PMR € 14,70 1 013420003

### 1343

talheadeira chata com lâmina oblíqua



L mm € 37,00 5 013430001

## 1344A/VW

ferramenta de remoção do gancho de fixação para puxadores Volkswagen



L mm 260 € 19,60 1 013440100

## 1345

martelo com cabeça convexa redonda e pena, larga cabo em madeira



1345 € 52,50 2 013450010

## 1351

martelo com cabeça plana redonda e pena pontiaguda, cabo em madeira



1351 € 52,50 2 013510010

## 1353

martelo com cabeças redondas plana e convexa, cabo em madeira



1353 € 52,50 2 013530010

## 1357Z/45

martelo com cabeça redonda serrilhada e quadrada plana, cabo em madeira



1357Z/45 € 86,00 2 013570045

## 1359T

martelo com cabeça plana redonda e pena horizontal, cabo em madeira



1359 T € 52,50 2 013590010

## 1360/K6

Martelo de alumínio com batente plano, com pinos de plástico intermutáveis e punção

Fornecido com :  
- 4 pinos de plástico  
- 1 punção, ajustável  
em dois comprimentos diferentes, aplicável ao martelo



L mm 320 Ø mm 34 € 99,50 1 013600006

## 1360/KP3

Kit de martelos plásticos com ponta redonda e pontiaguda, com punção

Kit contém:  
• 1 martelo de 210 g com cabeça Ø 30 mm  
• 1 martelo de 290 g com cabeça Ø 40 mm  
• 1 punção de 75 g com ponta 5 mm



1360/KP3 € 95,50 1 013600503

## 1361/C12

Conjunto de pontas em Teflon® para reparação de carroçarias



1361/C12 € 150,00 1 013610012  
275x160x57 mm

## 1361/K9

kit de 8 pontas para reparação de carroçarias

kit inclui:

- ponta de cabeça esférica, Ø 31 mm, comp. 110 cm
- ponta em bico, comp. 62 cm
- ponta cauda de baleia, comp. 112 cm
- ponta de gancho, comp. 27 cm
- ponta de cabeça redonda plana, comp. 50 cm
- ponta de cabeça esférica, Ø 19 mm, comp. 52 cm
- ponta cauda de baleia, comp. 27 cm
- ponta redonda cauda de baleia, comp. 28 cm
- saco em tecido com pegas

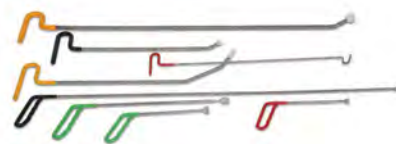

1361/K9 € 353,00 1 013610030

## 1364SE

apoio extensível para oficina

Especificações:

- 4 rodízios giratórios, 2 com travões
- pantógrafo extensível até 1400 mm
- regulação vertical até 1315 mm
- bloqueio de posição
- superfície de contacto com revestimento amovível em borracha

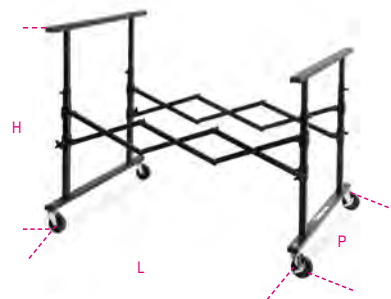

L mm 215÷1400 H mm 780÷1315 P mm 890 € 466,00 1 013640001

## 1364SV

apoio para oficina com tabuleiro central

Especificações:

- superfície de contacto com revestimento em polietileno
- dimensões do tabuleiro: 340x845x40 mm
- dobrável



H mm 1000 € 265,00 1 013640002

## 1364SCP

apoio giratório para oficina

particularmente adequado para capôs, laterais e portas equipado com 4 rodízios - 2 giratórios com travões, podem ser rodados até 180°



H mm	L mm	P mm	€		
1300	1100	680	425,00	1	013640003

## 1364SP

suporte de trabalho com ventosas

particularmente adequado para usar com janelas equipado com 4 ventosas, Ø 95 mm extensão ajustável através de corrente tubos com revestimento em polietileno



H mm	L mm	€		
1250	950	212,00	1	013640004

## 1364SR

trolley para rolos de papel

Especificações:

- com 2 rodas
- 3 barras para rolos de papel com lâmina de corte integrada
- suporte para fita cola integrado
- dimensões máx. do rolo de papel: 350 - 650 - 1050 mm



L mm	P mm	H mm	H1 mm	€	
1530	520	1080	960	271,00	1 013640005

## 1365/K13

kit chapeiro com bomba hidráulica 10 t e acessórios em trolley

O kit inclui:

- bomba hidráulica, 10 t, com tubo 1,5 m comp., união1/2"
- pistão
- pinça; capacidade: 500 kg
- placa base, 150x90 mm
- base em L, 50x50 mm
- punção 4 pontos
- punção redonda, Ø 50 mm
- punção cunha, 43 mm
- extensão 240-mm
- extensão 450-mm
- extensão 475-mm
- cabeça em borracha
- união macho-macho para instalar acessórios



1365/K13	€		
	920,00	1	013650013

900x420x180 mm

## 1365P10

bomba hidráulica

tubo 1,5m comp, união 1/2"



1365P10	€		
	409,00	1	013650110

## 1366A

Tira mossas com kit de 19 pinos plásticos

Ideal para remover:

- mossas causadas por granizo
- mossas no estacionamento
- pequenas mossas em geral



1366A	€		
	104,00	1	013660200

## 1366B

contrapeso para pinos plásticos tira mossas

peso percursor: 500 g



L mm	€		
440	58,00	1	013660250

## 1366KF

Conjunto de 19 pinos plásticos, para artigo 1366A



1366/KF	€		
	37,50	1	013660205

## 1366/K5

tira-mossas pneumático, com percursor de 1.1 kg

O kit inclui:

- 1 ventosa Ø 75 mm
- 1 ventosa Ø 100 mm
- 1 ventosa Ø 125 mm
- 1 gancho



1366/K5	€		
	271,00	1	013660010

610x240x90 mm

## 1068

alicate de pressão ajustável com contrapeso

contrapeso: 1 kg

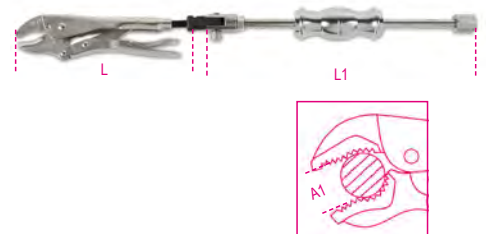

L mm	L1 mm	A1 Max mm	€	
260	365	19	139,00	1 010680000



## 1366SH

aparelho de soldar por pontos multifunções

- microprocessador para gestão dos parâmetros de soldadura
- início automático por contacto ou manual
- função de configuração do tempo de soldadura por pontos
- fornecido com pistola com encaixe rápido e cabo terra de 2.2m comp.

Kit de acessórios inclui:

- martelo extrator
- cabeça cilíndrica para anilhas de três pontas
- 10 anilhas de três pontas
- elétrodo de carvão
- elétrodo de compressão



Características técnicas:

- Alimentação: 230V
- 50% potência: 2.5 KVA
- Pico de potência: 13 KVA
- Amp. De saída: 2850 (2%) A
- Amp. Máx. de saída: 3200 A

1366SH € 2.320,00 1 013660400

## 1366SH/C

trolley para aparelho de soldar por pontos 1366SH



1366SH/C € 452,00 1 013660410

## 1366SL

alavanca tira-mossas para superfícies metálicas

Cabeça articulada com garra para utilização com arame ondulado



L mm € 273,00 1 013660002

## 1366S/R1

Mandril 3 pontas



1366S/R1 € 27,00 1 013660501

## 1366S/R2

Anilhas de 3 pontas para trabalhos em chapa



1366S/R2 € 27,00 1 013660502  
Preço para 20 unid.

## 1366S/R3

electrodo para anilhas Ø 8x16x1.5 mm



1366S/R3 € 32,50 1 013660503

## 1366S/R4

Grampo, Ø 8x16x1.5 mm



1366S/R4 € 28,50 1 013660504

## 1366S/R5

Anilhas Ø 8x16x1.5mm



1366S/R5 € 15,60 1 013660505  
Preço para 100 unid.

## 1366S/R6

Electrodo para parafusos M5-M6



1366S/R6 € 31,00 1 013660506

## 1366S/R7

100 pinos auto-roscantes , 5x18 mm



1366S/R7 € 27,00 1 013660507

## 1366S/R8

100 pinos auto-roscantes, 5x25 mm



1366S/R8 € 37,00 1 013660508

## 1366S/R9

100 pinos roscados, M5 x 18 mm



1366S/R9 € 25,00 1 013660509

## 1366S/R10

10 anilhas com fenda



1366S/R10 € 17,30 1 013660510

## 1366S/R11

Electrodo para anilhas com fenda



1366S/R11 € 88,00 1 013660511

## 1366S/R12

Anilhas com fenda 10 90°



1366S/R12 € 34,50 1 013660512

### 1366S/R13

Eléctrodo de soldadura por pontos



1366S/R13	€ 63,50	1	013660513
-----------	---------	---	-----------

Preço para 5 unid.

### 1366S/R14

Eléctrodo de soldadura por pontos



1366S/R14	€ 30,50	1	013660514
-----------	---------	---	-----------

### 1366S/R21

arame ondulado para utilização com alavanca e barra tira-mossas



1366S/R21	€ 21,40	1	013660551
-----------	---------	---	-----------

Os preços indicados são para 10 unidades.

### 1366S/R22

suporte magnético para arame ondulado



1366S/R22	€ 74,00	1	013660552
-----------	---------	---	-----------

### 1366S/R24

olhal de tração M4



1366S/R24	€ 85,50	1	013660554
-----------	---------	---	-----------

Os preços indicados são para 5 unidades.

### 1366S/R25

olhal de tração M5



1366S/R25	€ 85,50	1	013660555
-----------	---------	---	-----------

Os preços indicados são para 5 unidades.

### 1366S/R26

olhal de tração M6



1366S/R26	€ 85,50	1	013660556
-----------	---------	---	-----------

Os preços indicados são para 5 unidades.

### 1367/K4

kit de 4 grampos para cavas de roda, tipo arco



Abertura máx. mordente: 6.5 mm

	L	H	S	€	1	013670010
1367/K4	mm 62	mm 40÷58	mm 15,7	76,50	1	013670010

### 1367/K10

Jogo de punções para instalação de sensores de estacionamento

Tamanhos incluídos:

• 17 - 18 - 18.2 - 19 - 20 - 22.5 - 24 - 26 - 26.7 - 32 mm



Ø 12 mm

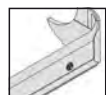

1367/K10	€ 210,00	1	013670200
----------	----------	---	-----------

190x130x58 mm

### 1368

kit de reparação para plásticos

• Permite reparar rapidamente componentes em plástico rachados ou partidos

Potência: 220÷240 V com tomada Schuko  
 Extensão cabo pistola de calor: 3.5 m  
 Comp. cabo eléctrico: 1.35 m  
 2 regulações de potência: 35-75 W  
 Pistola de aquecimento com terminais em latão, 2 ângulos de inserção do grampo: 0°-90°  
 Quebra-circuitos térmico de segurança na entrada  
 Fusível 10 A de segurança na saída  
 Bolsa para pistola

CE



1368	€ 490,00	1	013680001
------	----------	---	-----------

### 1368G/K400

sortido de 400 grampos para artigo 1368



1368G/K400	€ 84,00	1	013680140
------------	---------	---	-----------

### 1368G/OD

grampos roscados, a direito, para artigo 1368



1368G/OD	€ 21,00	1	013680100
----------	---------	---	-----------

Os preços indicados são para 100 unidades

### 1368G/SD

grampos em espiral, a direito, para artigo 1368



1368G/SD	€ 21,00	1	013680110
----------	---------	---	-----------

Os preços indicados são para 100 unidades

### 1368G/CV

grampos ângulo convexo para artigo 1368



1368G/CV	€ 21,00	1	013680120
----------	---------	---	-----------

Os preços indicados são para 100 unidades

### 1368G/C2U

grampos ângulo côncavo para artigo 1368



1368G/C2U	€ 21,00	1	013680130
-----------	---------	---	-----------

Os preços indicados são para 100 unidades





# PUNHOS DE MARTELOS

Punhos em madeira de **nogueira**

A nogueira apresenta excelentes propriedades para os punhos dos martelos. A sua estrutura de fibras longas absorve a vibração e torna-a muito resistente a quebras. No caso improvável dessas fibras quebrarem, o risco de queda da cabeça do martelo também é muito reduzido. Os punhos de madeira podem ser substituídos.

Como a madeira é um material natural, deverá reter a sua própria humidade. Assim, o martelo não deve ser armazenado em locais demasiado secos.

Punhos em **fibra de vidro**

Os punhos em fibra de vidro são duráveis e seguros; o risco de quebra e ferimentos é reduzido ao mínimo.

São à prova de intempéries e resistentes aos químicos mais comuns.



• Núcleo em fibra de vidro indestrutível

• Estrutura ergonómica em polipropileno

• Revestimento confortável em elastómero anti-derrapante

## 1369/C11

jogo de 11 ferramentas



1369/C11 € 980,00 1 013690033



470x340x70 mm - 15,2 kg

## 1370

martelos para mecânico tipo alemão, cabo em madeira



HICKORY

UNI 7778 DIN 1041

g	A mm	L mm	L1 mm	€		
100	15	260	82	13,90	5	013700051
200	19	280	95	15,60	5	013700052
300	23	300	105	17,80	5	013700053
400	25	310	112	20,20	5	013700054
500	27	320	118	21,70	5	013700055
600	30	330	122	25,00	5	013700056
800	33	350	130	28,50	4	013700058
1000	36	360	135	34,00	4	013700060
1500	42	380	145	38,50	2	013700065
2000	47	400	155	46,00	1	013700070

## 1370/MR...

cabos de substituição para referência 1370



	€		
1370MR 100 1370/100	6,30	4	013700081
1370MR 200 1370/200	7,00	4	013700082
1370MR 300 1370/300	7,60	4	013700083
1370MR 400 1370/400	8,10	4	013700084
1370MR 500 1370/500	8,90	4	013700085
1370MR 600 1370/600	9,80	4	013700086
1370MR 800 1370/800	10,20	4	013700088
1370MR 1000 1370/1000	10,90	4	013700090
1370MR 1500 1370/1500	12,40	4	013700095
1370MR 2000 1370/2000	13,90	4	013700100

## 1370T

martelos para mecânico cabo em fibra



g	A mm	L mm	L1 mm	€		
200	19	280	95	24,00	5	013700620
300	23	300	105	26,50	5	013700630
500	27	320	118	29,00	5	013700650
800	33	350	130	30,50	4	013700680
1000	36	360	135	38,50	4	013700700
1500	42	365	145	45,50	2	013700750

## 1370F

martelos para mecânico tipo alemão, cabo em madeira



NF E 71.014

A mm	L mm	L1 mm	€		
24	260	77	280	24,10	2 013700424
26	260	80	310	25,50	2 013700426
28	280	86	400	27,00	2 013700428
30	280	92	450	28,50	2 013700430
32	300	100	550	30,00	2 013700432
36	300	104	720	38,50	2 013700436
40	330	110	1065	42,50	2 013700440
42	330	116	1080	45,50	2 013700442
50	380	138	1760	47,50	2 013700450
60	380	160	2585	59,00	2 013700460



### 1370F/MR...

cabos de substituição para referência 1370F



	€		
1370F/MR 24 1370F/24-26	6,20	2	013700474
1370F/MR 28 1370F/28-30	6,70	2	013700478
1370F/MR 32 1370F/32-36	7,70	2	013700482
1370F/MR 40 1370F/40-42	9,70	2	013700490
1370F/MR 50 1370F/50	10,90	2	013700495
1370F/MR 60 1370F/60	13,20	2	013700496

### 1370FT

martelos para mecânicos, cabos em fibra



A mm	L mm	L1 mm		€		
28	280	86	530	39,50	1	013700528
30	280	92	625	41,00	1	013700530
32	300	100	750	42,50	1	013700532
36	300	104	930	51,00	1	013700536
40	330	110	1150	53,50	1	013700540
42	330	116	1250	55,50	1	013700542
50	380	138	2100	62,50	1	013700550
60	380	160	2750	67,50	1	013700560

### 1374F

martelo para carpinteiro tipo francês, cabo em madeira



A mm	L mm	L1 mm		€		
16	250	80	180	19,30	2	013740416
20	270	86	250	21,50	2	013740420
22	290	92	335	22,20	2	013740422
26	290	103	425	25,00	2	013740426
28	310	108	510	26,50	2	013740428
30	310	117	580	28,00	2	013740430

### 1374F/MR...

cabos de substituição para referência 1374F



	€		
1374F/MR 16 1374F/16	5,70	2	013740456
1374F/MR 20 1374F/20	5,80	2	013740460
1374F/MR 22 1374F/22-26	5,90	2	013740462
1374F/MR 28 1374F/28	6,70	2	013740468
1374F/MR 30 1374F/30	7,20	2	013740470

### 1375

martelo de orelhas, cabo em madeira



g	L1 mm	Ø mm	L mm	€		
300	95	25	300	22,20	3	013750000

### 1375/MR

cabos de substituição para referência 1375



	€		
1375/MR	10,10	2	013750003

### 1375A

martelo de orelhas, cabo em plástico e fibra de vidro



oz	g	L mm	L1 mm	€		
16	450	330	130	32,00	3	013750016
20	570	330	130	34,00	3	013750020

### 1375B

martelo de orelhas, cabo em aço



oz	g	L mm	L1 mm	€		
16	450	330	130	29,50	3	013750026
20	570	330	130	30,00	3	013750030

### 1376X

martelo de carpinteiro com orelhas magnetizadas, cabo de madeira



g	A mm	L1 mm	L mm	€		
250	20	125	450	21,20	3	013760125
300	25	130	450	22,40	3	013760130
400	27	132	450	24,60	3	013760140

### 1376X/MR

cabo de substituição para o artigo 1376X



	€		
1376X/MR	11,90	2	013760161

### 1376XT

martelo de carpinteiro com orelhas magnetizadas, cabo em material plástico



g	A mm	L1 mm	L mm	€		
250	20	125	500	25,50	3	013760525
300	25	130	500	27,00	3	013760530
400	27	132	500	29,00	3	013760540

### 1376XT/MR

cabo de substituição para o artigo 1376XT



	€		
1376MR/XT	13,80	2	013760585

### 1377

martelos com batente redondo e pena esférica, cabo em madeira



g	L mm	L1 mm	€		
340	330	95	32,00	2	013770134
450	350	102	34,00	2	013770145
570	350	110	38,50	2	013770157
680	360	116	40,50	2	013770168
900	380	120	42,00	2	013770190

### 1377/MR...

cabos de substituição para referência 1377



	€		
1377MR 340 1377/340	7,10	2	013770234
1377MR 450 1377/450	8,10	2	013770245
1377MR 570 1377/570	9,00	2	013770257
1377MR 680 1377/680	9,10	2	013770268
1377MR 900 1377/900	11,40	2	013770290

## 1377T

Martelo batente redondo e pena simétrica, cabo redondo em fibra, para trabalhos em latão ou estanho



g	L mm	L1 mm	€	U	IT
340	330	95	30,00	2	013770534
450	350	102	36,00	2	013770545
570	350	110	39,50	2	013770557
680	360	116	42,00	2	013770568
900	380	120	48,00	2	013770590

## 1378

martelos com batente redondo e pena simétrica, cabo em madeira



HICKORY

g	L mm	L1 mm	Ø mm	€	U	IT
340	330	100	27	29,50	2	013780134
570	350	115	32	38,50	2	013780157

## 1378/MR...

cabos de substituição para referência 1378



g	L mm	L1 mm	€	U	IT
1378MR 340			6,70	2	013780234
1378MR 570			9,30	2	013780257

## 1379F

martelo tipo francês para electricista, cabo em madeira

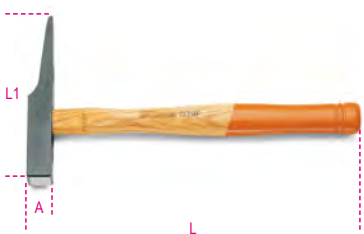

HICKORY

NF E 71.011

A mm	L mm	L1 mm	€	U	IT
16	250	126	19,20	2	013790416
18	250	135	21,00	2	013790418
20	260	142	22,20	2	013790420

## 1379F/MR...

cabos de substituição para referência 1379F



g	L mm	L1 mm	€	U	IT
1379F/MR 16			6,00	2	013790426
1379F/MR 16-18					
1379F/MR 20			6,70	2	013790430
1379F/20					

## 1380

marretas cabo em madeira



HICKORY

UNI 7777 DIN 6475

g	A mm	L mm	L1 mm	€	U	IT
800	38	260	90	24,60	2	013800208
1000	40	260	95	26,50	2	013800210
1250	43	260	100	28,00	2	013800212
1500	45	280	110	32,00	2	013800215
2000	50	300	120	41,50	2	013800220

## 1380/MR...

cabos de substituição para referência 1380



g	L mm	L1 mm	€	U	IT
1380MR 800			7,80	2	013800238
1380/800-1000-1250					
1380MR 1500			8,40	2	013800245
1380/1500					
1380MR 2000			9,60	2	013800250
1380/2000					

## 1380S

marretas com colar salva mãos cabo em madeira



g	A mm	L mm	L1 mm	€	U	IT
800	36	260	90	27,00	2	013800400
1000	39	260	95	30,00	2	013800405
1250	43	260	100	32,00	2	013800410
1500	45	260	110	36,00	2	013800415

## 1380S/MR...

cabos de substituição para referência 1380S



g	L mm	L1 mm	€	U	IT
1380S/MR 800			8,10	2	013800417
1380S/800-1000-1250					
1380S/MR 1500			8,90	2	013800419
1380S/1500					

## 1380T

Marreta, cabo em fibra



g	A mm	L mm	L1 mm	€	U	IT
800	35	260	85	37,50	2	013800308
1000	40	260	100	38,00	2	013800310
1250	42	260	110	40,50	2	013800312
1500	45	260	120	43,00	2	013800315
2000	49	295	120	52,50	1	013800320

## 1381

marretas serviço pesado cabo em madeira de castanheiro americano



HICKORY

g	A mm	L mm	L1 mm	€	U	IT
3000	55	800	142	101,00	1	013810030
4000	60	900	152	112,00	1	013810040
5000	70	900	162	127,00	1	013810050
8000	80	900	185	220,00	1	013810080

\* = cabo em madeira freixo

## 1381/MR...

cabos de substituição para referência 1381



g	L mm	L1 mm	€	U	IT
1381MR 3-4			49,50	2	013810730
1381/3000-4000					
1381MR 5			52,00	2	013810750
1381/5000					
1381MR 8			52,00	2	013810780
1381/8000					

## 1381T

marreta com cabo em fibra



g	A mm	L mm	L1 mm	€	U	IT
3000	55	900	142	109,00	1	013810330
4000	60	900	152	120,00	1	013810340
5000	70	900	162	137,00	1	013810350
8000	82	920	180	252,00	1	013810380

## 1385

marretas com cabeça em cobre  
cabo em madeira



g	A mm	L mm	L1 mm	€		
400	26	260	75	38,00	2	013850404
600	32	270	80	55,50	2	013850406
800	34	280	90	72,50	2	013850408
1000	37	280	100	90,00	2	013850410
1500	43	280	110	133,00	2	013850415
2000	48	300	120	179,00	1	013850420

## 1385/MR

cabo de substituição para o artigo 1385



	€		
1385MR 400 1385 400	10,90	2	013850464
1385MR 600 1385 600	11,30	2	013850466
1385MR 800 1385 800	11,60	2	013850468
1385MR 1000 1385 1000	12,50	2	013850470
1385MR 1500 1385 1500	13,90	1	013850475
1385MR 2000 1385 2000	14,20	1	013850480

## 1390

martelos com batentes plásticos  
intermutáveis, cabo em madeira



UNI 7784

Ø mm	L mm	L1 mm	€		
22	260	70	21,70	5	013900022
28	280	85	27,00	5	013900028
35	310	95	36,50	5	013900035
45	320	107	58,50	4	013900045
60	380	128	99,00	2	013900060

## 1390/MR...

cabos de substituição  
para referência 1390



	€		
1390MR 22 1390/22	5,30	2	013900222
1390MR 28 1390/28	6,20	2	013900228
1390MR 35 1390/35	7,30	2	013900235
1390MR 45 1390/45	8,90	2	013900245
1390MR 60 1390/60	10,90	2	013900260

## 1390R

batente de substituição para refª. 1390



Ø mm	€		
22	3,45	4	013900122
28	5,30	4	013900128
35	7,10	4	013900135
45	11,90	4	013900145
60	20,70	4	013900160

## 1390N

Martelo com batentes em plástico, cabo em  
madeira

Batentes dureza média: 75 Shore  
Resistente a óleo e ao desgaste  
Particularmente adequado para trabalhar metal



UNI 7784

Ø mm	L mm	L1 mm	€		
22	260	70	21,70	3	013900522
28	280	85	27,00	3	013900528
35	310	95	36,50	3	013900535
45	320	107	58,50	2	013900545
60	380	128	99,00	2	013900560

## 1390NR

batentes em nylon de substituição para ref.  
1390N



Ø mm	€		
22	3,45	4	013900622
28	5,30	4	013900628
35	7,10	4	013900635
45	11,90	4	013900645
60	20,70	4	013900660

## 1391

martelos anti-recuo totalmente  
revestidos a borracha



Ø mm	L mm	L1 mm	€		
35	280	90	33,50	2	013910135
50	320	105	43,00	2	013910150
55	355	110	51,50	2	013910155
65	380	130	70,50	2	013910165

## 1391A

maceta para assentar tijoleira  
totalmente revestida a borracha branca



g	Ø mm	L mm	L1 mm	€		
500	45	290	100	31,00	2	013910205
1000	60	300	120	41,50	2	013910210

## 1392

martelos anti-recuo com batentes  
intermutáveis, cabo em aço



Ø mm	L mm	L1 mm	€		
30	300	105	56,50	2	013920030
35	305	115	60,00	2	013920035
40	310	125	69,50	2	013920040
50	325	135	81,50	2	013920050
60	385	155	126,00	2	013920060

## 1392R

batente de substituição para refª. 1392



Ø mm	€		
30	7,60	4	013920230
35	11,10	4	013920235
40	16,70	4	013920240
50	22,30	4	013920250
60	33,50	4	013920260

## 1393

martelo com batente em borracha dura



Ø mm	L mm	L1 mm	€		
50	315	90	14,80	3	013930050
60	340	110	16,70	3	013930060
70	370	130	20,10	2	013930070



# REPARAÇÃO DE VEÍCULOS

As nossas ferramentas para reparação de veículos, usadas pelos profissionais mais exigentes, são desenvolvidas e fabricadas para cumprir as normas mais rígidas a nível mundial, e são testadas com regularidade sob as mais difíceis condições de trabalho.

Há mais de 50 anos que temos o orgulho de trabalhar de mãos dadas com os melhores, que nos ajudam a melhorar continuamente os nossos produtos e são testemunhas dos mais elevados padrões de qualidade.

**As ferramentas de reparação de veículos encontram-se nas seguintes secções:**

## Diagnóstico

itens 1464T/N a 1465  
itens 1498SM a 1499  
itens 1758VT a 1760/IR 1600

## Motor

itens 955 a 960SN  
itens 1440 a 1462/KEP  
itens 1472 a 1485TC  
itens 1737 a 1759TT

## Óleo e filtros

itens 1488/1 a 1496/C  
itens 1877 a 1889N

## Sistema elétrico

itens 1489/33 a 1489Y  
itens 1497D a 1497RC

## Arrancadores

itens 1498BC/12 a 1498DG1100E

## Transmissão

itens 1884 a 1885/X C60  
itens 1438 a 1438DSG  
itens 1566N a 1569/F

## Suspensão

itens 1550U a 1567

## Travões

itens 1466/C5 a 1471T/C5

## Rodas

itens 720MRC a 729T  
itens 962 a 989B  
itens 1530/C5 a 1531/C7

## Carroçaria

itens 1065F5 a 1068  
itens 1302 a 1369/C11  
itens 1478 a 1479U/32  
itens 1505V a 1539  
itens 1763 a 1768

## Outros equipamentos

itens 1875LT a 3067

## Elevação

itens 3006 a 3069

## 1410/M

chave de gancho para molas



Ø mm	€	🔧	📦
3,5	21,30	2	014100051

## 1428

extractor de porcas com quadra macho



Ø mm	□ mm	L mm	Ø mm	€	🔧	📦
8	3/8	36	17	20,10	2	014280008
10	3/8	36	17	20,10	2	014280010
11	3/8	36	17	20,10	2	014280011
12	3/8	36	19	20,10	2	014280012
13	3/8	36	19	20,10	2	014280013
14	3/8	36	19	20,10	2	014280014
15	1/2	38	21	21,30	2	014280015
16	1/2	38	21	21,30	2	014280016
17	1/2	38	21	21,30	2	014280017
18	1/2	38	26	21,30	2	014280018
19	1/2	38	26	21,30	2	014280019
20	1/2	38	26	23,60	2	014280020
21	1/2	38	26	23,60	2	014280021
22	1/2	38	26	25,50	2	014280022
24	1/2	38	26	25,50	2	014280024
27	1/2	38	26	27,00	2	014280027



Item	€	🔧	📦
1428/SB11 8-10-11-12-13-14 15-16-17-18-19 mm	245,00	1	014280111
1428/SB5 20-21-22-24-27 mm	136,00	1	014280115

## 1428L/B3



Item	€	🔧	📦
1428L/B3 17-19-21 mm	160,00	1	014280303

## 1429

extractor de porcas e parafusos com quadra macho



mm	□	L mm	€	🔧	📦
2	3/8	60	13,30	3	014290002
3	3/8	60	13,30	3	014290003
4	3/8	60	13,30	3	014290004
5	3/8	60	14,00	2	014290005
6	3/8	60	14,00	2	014290006
8	1/2	70	15,30	2	014290008
10	1/2	70	15,60	2	014290010



Item	€	🔧	📦
1429/SB7 2-3-4-5-6-8-10 mm	111,00	1	014290107

## 1430/...

extractores cónicos de parafusos em aço ligado

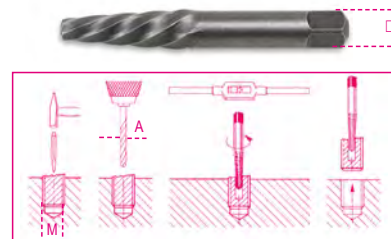

Item	M	A mm	□ mm	€	🔧	📦
1430/1	3÷6	2,5	3,0	3,70	10	014300006
1430/2	6÷8	3,0	4,0	4,15	10	014300008
1430/3	8÷11	4,5	5,0	4,95	10	014300011
1430/4	11÷14	6,0	6,3	6,60	10	014300014
1430/5	14÷18	8,0	8,8	7,40	10	014300018
1430/6	18÷24	11,0	11,7	14,50	5	014300024
1430/7	24÷33	14,0	14,8	21,80	5	014300033
1430/8	33÷50	21,0	20,0	28,00	5	014300050



Item	€	🔧	📦
1430/S5 1430/1-1430/2-1430/3 1430/4-1430/5	28,00	1	014300105
1430/S6 1430/1-1430/2-1430/3 1430/4-1430/5-1430/6	40,00	1	014300106
1430/S8 1430/1-1430/2-1430/3 1430/4-1430/5-1430/6 1430/7-1430/8	89,50	1	014300108

## 1431/...

extratores cônicos para parafusos e pinos

Para remoção de parafusos e pinos difíceis, com mecanismo de percussão

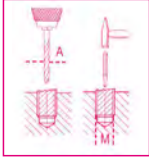

	M	A	L	□	€		
	mm	mm	mm	mm			
1431/3	3÷6	2,5	59	5	6,70	10	014310051
1431/5	6÷8	5,0	68	5	6,70	10	014310052
1431/6	8÷11	6,0	72	6	8,00	10	014310053
1431/8	11÷14	8,0	77	8	8,60	10	014310054
1431/9	14÷18	9,0	82	9	9,30	10	014310055

## 1431/C5

Extratores cônicos de parafusos e pinos

Mecanismo de percussão

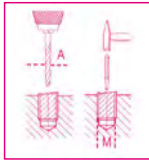

	M	A	€		
	mm	mm			
1431/C5	3÷18	2,5÷9	39,50	1	014310005

## 1433

Saca pernos

38"

12"

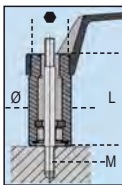

M	∅	L	•	□	€		
mm	mm	mm	mm				
5	21	60	19	3/8	14,80	2	014330005
6	24	60	21	1/2	14,80	2	014330006
7	24	60	21	1/2	14,80	2	014330007
8	24	60	21	1/2	14,80	2	014330008
9	28	70	21	1/2	17,60	2	014330009
10	28	70	21	1/2	17,60	2	014330010
10,5	28	70	21	1/2	17,60	2	014330021
11	28	70	21	1/2	17,60	2	014330011
12	28	70	21	1/2	17,60	2	014330012
14	36	72	24	-	28,00	2	014330014
16	36	72	24	-	28,00	2	014330016

## 1433/C11

saca pernos com roletes com encabadouro quadrado fêmea 1/2"

38"

12"



	€		
1433/C11	287,00	1	014330311
M5 - M6 - M7 - M8 - M9 - M10 - M10,5			
M11 - M12 - M14 - M16			
340x135x56 mm - 3,0 kg			

## 1435

extractor excêntrico de pernos

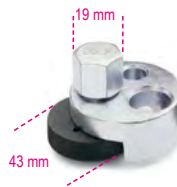

∅	€		
mm			
4÷20	108,00	1	014350001

## 1435R

patela excêntrica de substituição para a ref. 1435



	€		
1435R	33,50	1	014350010

## 1435/1

extractor excêntrico de pernos



∅	€		
mm			
19÷26	134,00	1	014350002

## 1435/1R

patela excêntrica de substituição para a ref. 1435/1

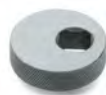

	€		
1435/1R	34,50	1	014350011

## 1438

aparelho para centrar embraiagens com 3 cones expansivos



	€		
1438	61,50	1	014380001

## 1438R

cones expansivos de substituição para a ref. 1438



∅	€		
mm			
14÷18	4,15	5	014380101
18÷21	4,15	5	014380102

## 1438EVO

Kit universal para alinhar embraiagens

Em metal



	€		
1438EVO	272,00	1	014380011
290x200x60 mm - 2 kg			

## 1438DSG

Alavanca para bloquear/desbloquear caixas de velocidades DSG de dupla embraiagem do grupo VAG



	€		
1438DSG	37,00	1	014380200

## 1439/K7

porta-pontas angular (90°), série longa, com pontas, em caixa



Conteúdo da caixa:

- Porta-pontas angular
- 1 cabeça para parafusos de perfil de fenda
- 1 cabeça 1/4" para pontas
- 1 cabeça especial para pontas
- 7 pontas especiais

1439K7 € 227,00 1 014390101

500x120x60 mm 825 g

## 1440/...

cintas para segmentos



	Ø mm	L mm	€		
1440/0	40÷75	50	34,00	1	014400000
1440/1	57÷125	80	44,00	1	014400010
1440/1A	57÷125	100	50,50	1	014400011
1440/2	90÷175	80	53,50	1	014400020
1440/2A	90÷175	100	56,50	1	014400021
1440/3	90÷175	165	82,00	1	014400030

## 1445/1 - 1445/2

grampo para segmentos



	Ø mm	€		
1445/1	50÷100	46,50	1	014450001
1445/2	90÷150	59,50	1	014450002

## 1452K

compressor de molas de válvulas, com três matrizes

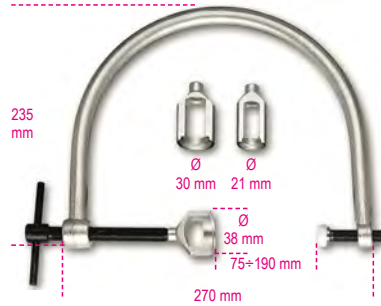

1452K € 177,00 1 014520100

## 1452PN/K

compressor pneumático para molas de válvulas

Pressão de impulso: 1400 N

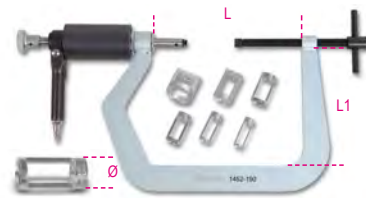

Ø mm	L mm	L1 mm	€		
16-19-23	230	185	375,00	1	014520110
25-30-42					

## 1454P

raspador para remover resíduos de embalagem e selante

Particularmente recomendado para limpeza de cabeças e superfícies planas



L mm	L1 mm	± mm	€		
210	32	3,3	49,00	1	014540010

## 1455SVP

rectificador de válvulas pneumático

• Pressão de alimentação: 6 bar

CE



1455SVP € 429,00 1 014550001

## 1455SVP/R...

ventosas em borracha de substituição para a refª. 1455SVP



	€		
1455SVP/R1	7,70	5	014550501
1455SVP/R2	7,70	5	014550502
1455SVP/R3	7,70	5	014550503

## 1457/B4

jogo de ferramentas para remover uniões de tubos Rilsan

Tamanhos incluídos:

- 6x8
- 10x12
- 15x16
- 18x1/2



1457/B4 € 57,50 1 014570024

## 1458

alicate para anéis de segurança



DIN 5417

Ø mm	€		
30÷100	84,00	2	014580001

## 1460F

alicate para as juntas de afinação das válvulas



1460F € 72,00 1 014600010





## 1462CF/C6

Jogo de 6 chaves de caixa bi-sextavadas para injectores

Tamanhos:  
12-14-16-17-18-19 mm



1462CF/C6 € 112,00 1 014620006  
≡ 260x145x60 mm - 1,2 kg

## 1462CF

Jogo de chaves de caixa bi-sextavadas para injectores



mm	€		
12	17,80	1	014620012
14	18,00	1	014620014
16	18,40	1	014620016
17	18,80	1	014620017
19	19,80	1	014620019
18	19,20	1	014620018

## 1462/KEP

extrator pneumático de injectores diesel

Os conectores fornecidos podem ser utilizados para ligar facilmente o macaco pneumático ao alojamento roscado do injetor.

O controlo remoto permite um funcionamento totalmente seguro; enquanto que o macaco fornece uma potente força de sopro (até 1200 bpm).

Especificações:

- Controlo remoto
- Pega de posicionamento
- União roscada M18X1.5
- Curso do saca-anilhas: 35 mm
- Velocidade do saca-anilhas: 1200 bpm

Conectores incluídos no kit:

- M14X1.5 para Delphi
- M17X1.0 para Bosch
- M20X1.0 para Denso
- M25X1.0 para Siemens
- M27X1.0 para Siemens



1462/KEP € 436,00 1 014620250  
≡ 385x300x110 mm - 4,8 kg

## 1462/KI

Jogo de extractores de injectores common rail diesel

Permite a remoção de injectores DELPHI-BOSCH-SIEMENS-DENSO



1462/KI € 2.900,00 1 014620235  
≡ 530x470x140 mm - 2,0 kg

## 1462/MB

kit para extração de injectores

Inclui:

- 1 4 kg contrapeso com haste 400 mm
- 1 adaptador articulado, macho M10x1.5, fêmea M22x1.5 mm
- 1 adaptador, macho M22x1.5, fêmea M13x1.4 mm
- 1 adaptador, macho M14x1.5, fêmea M27X1 mm
- 1 adaptador, macho M14x1.5, macho M25x1 mm
- 1 adaptador, macho M14x1.5, macho M27x1 mm
- 1 adaptador, macho M14x1.5, fêmea M14x1.5 mm
- 1 adaptador, macho M14x1.5, macho M20x1 mm
- 1 adaptador, macho M14x1.5, macho M17x1 mm



1462/MB € 349,00 1 014620110  
≡ 500x250x80 mm - 7,2 kg

## 1462/EI

Ferramenta de vibração universal para extração de injectores

- Facilita a extração total dos injectores mais apertados, sem danificar as cabeças dos cilindros e sem partir os injectores.
- Pode ser utilizado com qualquer outro conjunto de extração de injectores, com ou sem martelo.
- A ferramenta atua diretamente na rosca do injetor, através de vibrações
- A válvula de controlo permite regular a intensidade da vibração.



1462/EI € 770,00 1 014620240

## 1464T/N

compressómetro digital

- ecrã digital de grandes dimensões, retroiluminado
- bateria de polímero de lítio recarregável
- com sensor de 80 bar (para baixa pressão)
- ligação através de sensor sem fio
- transferência de medições e atualização de software através de Wi-Fi
- corpo anti-impacto
- para utilizar em combinação com kits 1464 para testar a pressão e a compressão do motor



Características técnicas:

- Ecrã: 8"
- Resolução: 800x840 px
- Processador: Dual core 240 MHz
- Memória interna: 32 Mb
- Software: 32-bits

L H P  
mm mm mm  
1464T/N 460 120 360 € 1.120,00 1 014640090

## 1464T/SP80

sensor de pressão, 8 bars, para referências 1464T, 960TP e 1464T/N



1464T/SP80 € 350,00 1 014640053

## 1464CBD

jogo de adaptadores para teste de compressão em motores a gasolina e diesel, com compressómetro 1464T e 1464T/N

Possibilita a ligação ao motor para testar a compressão de gasolina ou diesel com o dispositivo 1464T

Inclui:

- 8 velas de ignição falsas com válvulas de não-retorno
- 44 velas de incandescência falsas com válvulas de não-retorno
- 1 injetor falso universal ajustável para motores de ligeiros, pesados, embarcações e máquinas agrícolas
- 1 adaptador 90° adapter, válvula de pressão e tubo de ligação
- espaço de arrumação para compressómetro 1464T



1464CBD € 835,00 1 014640300  
≡ 510x410x140 mm - 5,5 kg

## 1464APD

kit para teste do sistema de alta pressão em motores common rail diesel (pode ser utilizado com os artigos 1464T e 1464T/N)

Permite a ligação entre a bomba de alta pressão e a régua de injeção, para testar a pressão do sistema common rail. Se não houver pressão disponível, os adaptadores incluídos no kit permitem determinar se o problema está na bomba de pressão ou no regulador.

Kit inclui:

- jogo de mangueiras de alta pressão
- acessórios
- sensor 2000 bar
- jogo de adaptadores
- jogo de tampões para injetores de combustível



Tamanhos de mangueira fornecidos:

- T12X12-M1.5
- T12x14-M1.5
- T12x16-M1.5
- T12-M1.5

Reguladores de pressão Bosch, Delphi, Denso e Siemens

1464APD 1.040,00 € 1 014640100

510x415x130 mm - 4,7 kg

## 1464APB

Kit para teste do sistema de alta pressão em motores gasolina FSI, com artigo 1464T e 1464T/N

Equipado com sensor 200 bar e conectores



1464APB 453,00 € 1 014640500

240x210x50 mm - 0,5 kg

## 1464BP

jogo de conectores para teste de baixa pressão de combustível (pode ser utilizado com os artigos 1464T e 1464T/N)

Conectores rápidos para dispositivo de teste 1464T/N para rápida verificação da baixa pressão do combustível em motores a gasolina e a diesel bem como a pressão do AdAzul® e do TDI.



1464BP 545,00 € 1 014640200

510x415x130 mm - 2,6 kg

## 1464PO

jogo para teste da pressão do óleo (para utilização com os artigos 1464T e 1464T/N)

Utilizado com o compressômetro digital e os conectores fornecidos, permite testar a pressão do óleo do motor.



Jogo inclui:

- 10 acessórios para a pressão do óleo do motor
- 4 acessórios para a pressão do óleo da turbina
- adaptador 90°
- extensão de borracha com engate rápido

1464PO 240,00 € 1 014640270

350x290x90 mm - 1,3 kg

## 1464FAP

kit para teste da pressão do filtro de partículas diesel (DPF)

para item 1464T e 1464T/N

Inclui:

- sensor 500 mbar
- adaptador 8 mm com engate rápido e união em T
- cabo RJ45 com 3m de comprimento



CARACTERÍSTICAS TÉCNICAS

Teste de pressão: 0+500 mbar  
Resolução: 1 mbar

1464FAP 225,00 € 1 014640610

240x210x50 mm - 0,5 kg

## 1464PT

Kit para teste da pressão do turbo, com artigo 1464T

Equipado com sensor e cabo de ligação



1464PT 198,00 € 1 014640550

240x210x50 mm - 380 g

## 1464VD

jogo para teste de vácuo para item 1464T e 1464T/N

Para medir e armazenar o valor máximo de vácuo

Fornecido com:

- sensor de 800 mbar
- adaptadores de 6 e 8 mm
- Cabo RJ45 de 3 m de comprimento

CARACTERÍSTICAS TÉCNICAS

Teste de vácuo: 0+800 mbar  
Resolução: 1 mbar  
Armazenamento do valor máximo



1464VD 225,00 € 1 014640570

240x210x50 mm

Beta

Beta





## 1465

Teste de compressão do motor

Permite testar compressão endotérmica do motor em apenas alguns segundos, sem necessidade de ligação ao motor, o dispositivo é alimentado pela bateria do veículo, através de um software



CE

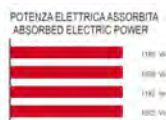
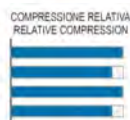

- Passo 1: cálculo da rotação do motor  
 Passo 2: testar a evolução da voltagem da bateria durante cada rotação  
 Passo 3: exibir a potência absorvida e calcular a compressão através do arranque de cada pistão  
 Passo 4: testar a carga e eficiência da bateria

CARACTERÍSTICAS TÉCNICAS  
 Voltagem: 12V (bateria do veículo)  
 Dimensões: 140x75x30 mm  
 Comprimento do cabo: 1300mm

1465 € 1.370,00 1 014650010

## 1466/C5

Kit de 5 chaves para extração de líquido de travões

- Contém:
- 5 chaves tamanhos 7-8-9-10-11 mm
  - 1 tubo de drenagem com válvula de retenção



1466/C5 € 150,00 1 014660100

≡ 260x170x50 mm - 600 g

## 1467

extractor de líquido de travões



Pressão: min 5 bar, max 11.5 bar

1467 1,5 € 398,00 1 014670001

## 1467/RK1

kit de substituição de tubo para artigo 1467



1467/RK1 € 30,00 1 014670501

## 1467LF/2

instrumento elétrico para substituição do líquido dos travões com função "efeito pulsante"



CE

"Efeito pulsante"

- Pára automaticamente quando o depósito está vazio, evitando a entrada de ar
  - Volume máximo do depósito: 20 l
  - Pressão de trabalho: 0.4+3.5 bar
  - Alimentação: 230V
- Fornecido com:
- Depósito de recolha do óleo dos travões
  - 1 adaptador standard E20

1467LF/2 € 2.080,00 1 014670099

## 1467LF/RC

recipiente com tubo de recuperação de líquido de travões para artigo 1467LF



1467LF RC € 126,00 1 014670125

## 1467TU

Conector para tanques de recuperação de líquido dos travões

- adaptável a 90% dos modelos de tanque disponíveis
- para utilização conjunta com item Beta 1467LF



1467TU € 78,00 1 014670090

## 1467T/C6

jogo de conectores para tanques de recuperação de líquido dos travões, para utilização com os itens BETA 1467LF e 1467LF/2

Inclui:

- 1 conector para veículos Toyota
- 1 conector para veículos Ford, Hyundai, Mazda, Mitsubishi, Nissan, Subaru
- 1 conector para veículos Honda
- 1 conector para veículos Mazda e Suzuki
- 1 conector para veículos Nissan
- 1 conector de sangrar travões para veículos europeus



1467T/C6 € 317,00 1 014670080

≡ 350x240x85 mm - 1,8 kg

## 1470

alicate para as molas dos travões de tambor



L mm	€	1	014700001
210	46,50	1	014700001
330	59,50	1	014700002
540	179,00	1	014700010



## 1470FT

Alicate para as molas dos travões de tambor

Pontas em ângulo de 40°  
Acesso fácil a espaços exíguos

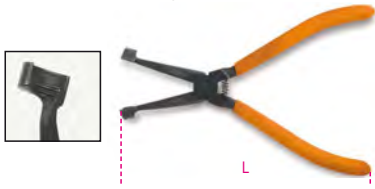

L mm 184 € 49,00 1 014700000

## 1471

alicate para as molas dos travões de tambor



L mm 330 € 90,50 1 014710001

## 1471GF

Par de ganchos moldáveis para suporte de pinças de travão para substituição de pastilhas



1471GF Max kg 5 € 16,70 1 014710310

## 1471M/C22

ferramenta pneumática para rodar e recuar os êmbolos de travões direitos e esquerdos, com acessórios



1471M/C22 € 356,00 1 014710101  
350x310x85 mm - 3,5 kg

## 1471M/50

ferramenta pneumática para rodar e recuar os êmbolos de travões direitos e esquerdos, com acessórios

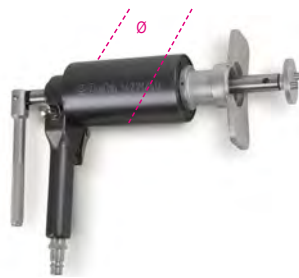

Ø mm 50 Kg 150 Bar 5÷8 € 196,00 1 014710069

## 1471C

ferramenta para recuar êmbolos dos discos de travões, com roquete



L mm 245 A min+Max 40÷65 € 72,00 1 014710330

## 1471CF

chave de caixa pentagonal para aperto de porcas de pinças de travões



mm 14 € 21,00 1 014710314  
19 € 21,00 1 014710319

## 1471CM

chave de caixa pentagonal para aperto de parafusos de pinças de travões



mm 10 € 21,00 1 014710360

## 1471CM/E11

Chave de caixa sextavada, 11 mm, para parafusos das pinças de travão Mercedes ML (série 166)



mm 11 Ø mm 24 L mm 75 L1 mm 15,5 € 22,20 1 014710361

## 1471PT/C5

kit chaves de impacto para porcas de pinças de travão

para automóveis do grupo Volkswagen, Audi & Porsche  
• 3 chaves de 10 dentes: 11.5 mm - 15 mm - 20 mm  
• 2 chave de 7 dentes: Ø 14 mm - 22 mm



1471PT/C5 € 85,50 1 014710367

## 1471D2

ferramenta para recuar êmbolos dos discos de travões, com pinças fechadas

Dois pares de placas para trabalhar com 2 e 4 pinças



mm 10 € 92,00 1 014710301  
250x170x60 mm 1,5 kg

## 1471T/C5

5 chaves de pancada para pinças de travões de pesados

podem ser utilizadas com chaves dinamométricas para operações de aperto

tamanhos incluídos:  
• chaves Torx fêmea E18, E20, E24  
• chaves luneta M24, M26



1471T/C5 € 295,00 1 014710400

275x220x60 mm - 3,1 kg

## 1472

alicate para abraçadeiras



1472 € 52,00 1 014720001

## 1472AU

alicate para abraçadeiras



Ø mm 18+53 € 152,00 1 014720100

## 1472R/AU

pontas de substituição para alicate 1472AU



1472AU/R € 58,50 1 014720101

## 1472AU/P

alicate com extensão para abraçadeiras de fecho automático



Ø mm 18+54 L mm 630 € 134,00 1 014720105

## 1472AU/RP

cabo de substituição para alicate 1472AU/P



1472AUP/R € 32,50 1 014720106

## 1472B/RNLT

chave de caixa dupla, especialmente concebida para abraçadeiras de tubos de sucção instalados em motores do grupo Renault



1472B/RNLT € 21,20 1 014720250

## 1472FC

alicate para abraçadeiras Clic(R) com cabeça rotativa



1472FC € 48,00 1 014720090

## 1472FC/6E

alicate para abraçadeiras clic®

Particularmente adequado para abraçadeiras grandes dimensões



L mm 230 € 84,00 1 014720093

## 1472FC/L

alicate para abraçadeiras Clic® com extensão flexível

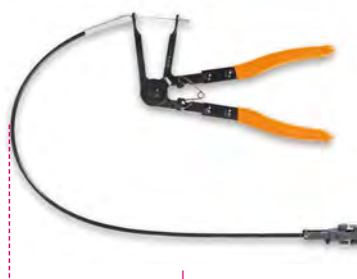

L mm 630 € 129,00 1 014720095

## 1472FCL/RP

cabo de substituição para alicate 1472FC/L



1472FCL/RP € 57,50 1 014720096

## 1472PU

alicate para abraçadeiras

os mordentes de múltiplas cabeças inclinados a 45° permitem a fixação da maioria das abraçadeiras disponíveis no mercado



Ø 0+65 L 228 € 80,00 1 014720120

## 1472PU/P

alicate para abraçadeiras com extensão

os mordentes de múltiplas cabeças permitem a fixação da maioria das abraçadeiras disponíveis no mercado



Ø 3+58 L 228 L1 630 € 118,00 1 014720121

## 1472VW

alicate para abraçadeiras, com cabeça rotativa  
Para viaturas Volkswagen e Mercedes



1472 VW € 54,00 1 014720051

### 1473

alicate para abraçadeiras OETIKER®



1473 275 € 150,00 1 014730001

### 1473A

alicate para abraçadeiras OETIKER®



1473A € 114,00 1 014730010

### 1473P

alicate para abraçadeiras OETIKER® de baixo perfil



1473P A Max mm 53 € 42,00 1 014730020

### 1473FN

alicate para abraçadeiras em aço inox

Para abraçadeiras Panduit(R) e similares



A mm 4,7±9,5 € 78,00 1 014730501

### 1474L

alicate para cachimbos de velas com bicos longos curvos a 15°

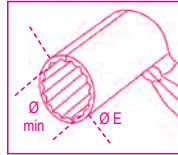

Ø min mm 14 Ø E mm 20 € 95,50 2 014740010

### 1474DL

alicates longos para cachimbos de velas com punhos de dupla camada em PVC



1474DL Ø 12 mm 275 mm € 46,00 1 014740015

### 1474G

Alicate para remover cachimbos de velas de incandescência



1474G € 51,50 1 014740200

### 1476

alicate de pressão com corrente para o corte de tubos de escape



Ø min mm 19 Ø max mm 75 L mm 225 € 92,00 1 014760002

### 1476/RC

corrente de substituição para ref. 1476



1476RC € 45,50 1 014760012

### 1476A

alicate com corrente para o corte de tubos de escape



Ø min mm 30 Ø max mm 95 € 117,00 1 014760005

### 1476A/RC

corrente de substituição para ref. 1476A



1476A/RC € 101,00 1 014760015

### 1476C/1

expansor de tubos de escape



1476C/1 € 44,00 1 014760101  
Ø 30÷42 mm  
L = 131 mm  
L1 = 51 mm

### 1476GT

alicate para remoção dos apoios em borracha dos tubos de escape



L mm 280 A Max mm 58 mm 3 € 40,50 1 014760050

### 1476PSA

alicate para abraçadeiras com pino do circuito de escape, grupo PSA  
A forma da ponta e o bloqueio automático da cremalheira possibilitam trabalhar sem extrair o pino



L mm 309 A Max mm 60 S mm 12,2 € 49,50 1 014760060



## 1477/C10

chave de aperto com 9 bits  
para porcas das polias de correias

1 chave de aperto  
4 bits bisextavados: 12x14 - 13x15 - 16x17 - 18x19 mm  
5 bits para parafusos Torx®: E10 - E12 - E14 - E16 - E18



1477/C10 € 192,00 1 014770310  
530x110x55 mm

## 1477/C38

kit com chave articulada de roquete, com chaves  
de caixa curtas para porcas das polias de correias

Kit inclui:

- chave articulada de roquete 500 mm comp.
- chaves de caixa curtas para parafusos Torx®: E10-E12-E14-E16-E18
- chaves de caixa curtas sextavadas: 8-9-10-11-12-13-14-15-16-17-18-19-24
- bits para parafusos Torx®: T20-T25-T27-T30-T40-T45-T50-T55-T60
- bits para parafusos Phillips® em cruz: PH2
- bits sextavados: 4-5-6-7-8-10 mm
- porta-bits magnético
- voltagem 3/8", 75 mm



1477/C38 € 262,00 1 014770338  
630x130x55 mm - 2 kg

## 1477D/S5

jogo 5 chaves de luneta para porcas de aperto



1477D/S5 € 172,00 1 014770200  
13-15-16-17-19 mm  
600x200x70 mm - 2,2 kg

## 1478

alicate para cavilhas



1478 € 66,50 1 014780001

## 1478NSS

alicate de remoção com pino em plástico com  
três pontos de desengate



L mm 180 € 48,00 1 014780163

## 1478T

alicate remoção de pinos em plástico  
com cabeça rotativa e clips de pressão

Cabeça rotativa a 90°



S mm 4,5 € 52,00 1 014780101

## 1478/K3

kit alicates remoção de pinos com sortido clips  
de plástico

conteúdo do kit:

- alicate de pontas chatas (1 unid.)
- alicate pontas curvas 90° (1 unid.)
- 625 clips de plástico em 16 tamanhos
- clips em 3 caixas PPL empilháveis



L mm 180 L1 mm 170 € 121,00 1 014780160

## 1478SP

sortido de 625 clips de plástico

16 tipos diferentes



1478SP € 29,00 1 014780201

## 1479

extractor de cavilhas

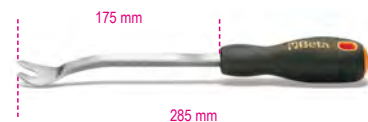

1479 € 29,50 2 014790001

## 1479/B27

kit 27 ferramentas de nylon para remoção de  
pinos  
e trabalhos em plásticos e vedantes,  
com possibilidade de suspensão



1479/B27 € 92,00 1 014790407

## 1479LB/C5

Kit de 5 extractores de cavilhas em metal



1479LB/C5 € 125,00 1 014790150  
215x165x50 mm

## 1479L/S2

Barras de desmontagem, par, Teflon®



1479L/S2 € 42,00 1 014790510

## 1479LV/S3

Kit de 3 alavancas multiusos em metal

Tamanhos:

1479LV/1: 10x12 mm

1479LV/2: 4.8x9.6 mm

1479LV/3: 2.8x6 mm



1479LV/S3 € 35,50 1 014790100

## 1479L/K4

4 alavancas multiusos para trabalhos em painéis e peças delicadas



1479L/K4 € 40,00 1 014790604

## 1479N/S5

kit de 5 extractores de cavilhas de nylon



1479N/S5 € 47,50 1 014790251

## 1479RB/1

raspador direito



1479RB/1 € 32,50 1 014790315

## 1479RB/2

raspador curvo



1479RB/2 € 32,50 1 014790320

## 1479RB/3

raspador espalmado



1479RB/3 € 37,00 1 014790310

## 1479U/13

extractor de cavilhas, lâmina em aço inoxidável



1479U/13 € 30,00 2 014790010

## 1479U/32

extractor de cavilhas, lâmina em aço inoxidável



1479U/32 € 35,50 2 014790015

## 1480

Kit para enchimento de filtros de óleo diesel sem recurso a bombas eléctricas

• Também para utilização com punhos de encher pneus

Conteúdo:

- uniões rápidas GM
- uniões rápidas Renault, GM, Fiat, Ø interno 6 mm
- uniões rápidas Renault, GM, Fiat, Ø interno 7 mm
- uniões rápidas Ford
- uniões rápidas PSA, Ø interno 6 mm
- uniões rápidas PSA, Ø interno 7 mm
- uniões rápidas Ford
- 2 adaptadores cónicos para veiculos sem uniões rápidas



1480 € 445,00 1 014800010

410x320x70 mm



# Beta



## 1481/C12

Kit de 6 pares de grampos para oclusão de tubos

Contém:

- 2 pares de grampos 1/4"
- 2 pares de grampos 3/8"
- 2 pares de grampos 5/16"
- 3 pares de tampas de borracha



1481/C12	€ 141,00	1	014810312
≡ 370x270x59 mm			

## 1481K/S4

Conjunto de 4 terminais de bloqueio por clampagem

tamanhos:

5/16" - 3/8" - 1/2" esférica



1481K/S4	€ 35,50	1	014810400
----------	---------	---	-----------

## 1481PL/A

grampos para oclusão de tubos

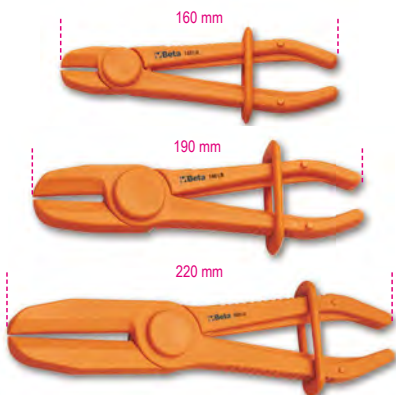

1481PL/A	8÷15	€ 24,10	3	014810110
1481PL/B	15÷25	€ 27,00	3	014810120
1481PL/C	25÷45	€ 36,50	3	014810130

## 1481PL/S3

jogo de 3 grampos para oclusão de tubos



1481PL/S3	€ 88,00	1	014810200
1481PL-A Ø 8÷15 mm			
1481PL-B Ø 15÷25 mm			
1481PL-C Ø 25÷45 mm			

## 1481T/C12

jogo tampões para linha de combustível

3 pares de tampões com uniões rápidas macho/fêmea para fechar linhas de combustível



1481T/C12	€ 146,00	1	014810212
≡ 275x220x45 mm - 540 g			

## 1482

chave para tampas de depósitos de combustível

chave regulável para montagem/desmontagem das tampas dos depósitos de combustível



Ø mm	€	1	014820001
89÷170	131,00		
89÷200	137,00	1	014820002

## 1482A/1B

chave de três pernas para tampas de depósitos de combustível em alumínio

Para porcas de anel em alumínio instaladas em automóveis Fiat, Volkswagen, Opel, Chevrolet, Mercedes e BMW a partir de 2011



Ø mm	€	1	014820004
185	90,50		

## 1482A/3

chave para tampas de depósitos de combustível, grupo PSA

Concebida para possibilitar o trabalho em eixos descentralizados, removendo a tampa sem danificar a linha de combustível



Ø mm	€	1	014820007
157	104,00		

## 1482/8 - 1482/10

alicates para ligações rápidas de tubos de combustível



1482/8	Ø mm 8	€ 45,50	2	014820008
1482/10	10	€ 45,50	2	014820010

## 1482B

alicate para ligações rápidas de tubos de combustível



1482B	€ 54,00	1	014820021
-------	---------	---	-----------

## 1482SN

alicate giratório de ação rápida para tubos de combustível, com mordentes articulados



L mm	€	1	014820110
260	69,50		



## 1482C

adaptadores (2 pares) para remoção de uniões de filtros diesel, para os grupos Fiat, Volkswagen, Jeep, Chrysler e Volvo

Rápida substituição do filtro sem danos irreparáveis nas uniões



1482C	€ 72,00	1	014820022
-------	---------	---	-----------

## 1483KV-PT/S7

jogo de bits cabeça em estrela

Tamanhos incluídos:  
PT10 - PT15 - PT20 - PT25 - PT27 - PT30 - PT40



1483KV PT/S7	€ 13,70	1	014830117
--------------	---------	---	-----------

## 1484

Jogo 2 ferramentas para remoção e instalação de cintas elásticas

Remoção rápida e instalação correcta de cintas elásticas sem danos



1484	€ 145,00	1	014840010
------	----------	---	-----------

## 1485BP

Chave meia-lua para polias dentadas

Pode ser ajustada através do punho (veio roscado), aperta e bloqueia a polia de fora, evitando que os sensores vizinhos fiquem danificados



A Max mm	€	1	014850000
130	258,00		

## 1485FCA/K2

ferramentas para pré-carregamento dos rolamentos da correia de distribuição, grupo FcA (par)

Recomendadas para motores 1.2, 1.4 8/16 V e 1.4 Multiair  
• 1 ferramenta 175 mm comprimento com hastes de 13.5 mm profundidade  
• 1 ferramenta articulada 305 mm comprimento com hastes de 13.5 mm profundidade



1485FCA/K2	€ 118,00	1	014850220
------------	----------	---	-----------

## 1485TC

Alavanca de tensão para correias dos motores Ford, PSA, FCA



L mm	€	1	014850330
475	56,50		

## 1485/KIT

kit para controlar a tensão da correia de distribuição



1485/KIT	€ 209,00	1	014850100
230x140x75 mm - 580 g			

## 1485R

ferramenta universal para rodar polias da árvore de cames em ferro fundido com 2 pares de ponteiras



∅ mm	∅1 mm	L mm	€	1	014850025
30÷120	10 - 17	500	180,00		

## 1485R/P10

par de pernos



1485R/P10	€ 19,30	1	014850035
-----------	---------	---	-----------

## 1485R/P17

par de pernos



1485R/P17	€ 19,30	1	014850038
-----------	---------	---	-----------

## 1488 - 1488L

chave articulada com corrente para filtros de óleo



	∅ mm	€	1	014880001
1488	60÷110	107,00		
1488L	60÷160	118,00		014880050

## 1488/1

chave articulada com corrente para filtros de óleo

12"

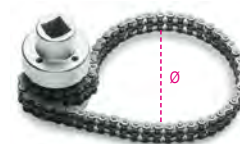

∅ mm	€	1	014880010
60÷110	124,00		

## 1488R...

corrente de substituição



	L mm	€	1	014880101
1488RC	1488 350	44,00		
1488R/L	1488/L 520	71,00		014880150
1488RC/1	1488/1	61,50		014880110

## 1489/33

chave para polias de alternadores Bosh



1489/33	33	€	19,20	1	014890010
---------	----	---	-------	---	-----------

## 1489/Y

chave para polias de alternador, para alternadores Nippondenso



32	€	22,10	1	014890040
----	---	-------	---	-----------

## 1490

chaves de correia para filtros de óleo

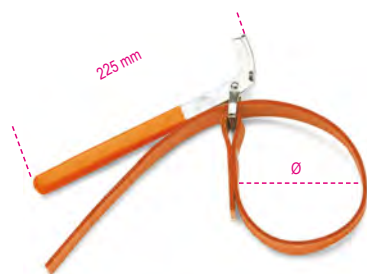

1490/1	160	€	42,50	1	014900001
1490/2	240	€	46,00	1	014900002

## 1490/R1 - 1490/R2

faixas de tecido sobresselentes para artigo 1490



1490R/1	160	€	20,80	1	014900101
1490R/2	240	€	25,50	1	014900102

## 1490F

Chaves de cinta para filtros

38"

12"



Ø Max	H	€	31,00	1	014900201
mm	mm				
200	50				

## 1491

chave para filtros de óleo com cinta metálica regulável



Ø	€	55,50	2	014910001
mm				
65÷110				

## 1491R

cinta metálica de substituição para ref. 1491



1491R	€	10,10	10	014910010
-------	---	-------	----	-----------

## 1491A

Alicate ajustável para filtros de óleo

Precisão ajustável através de dentado



L	Ø min - Max	€	37,50	1	014910040
mm	mm				
345	55 ÷ 140				

## 1491T

Alicate ajustável para filtro de óleo para pesados

Precisão ajustável através de dentado Utilização com filtros secos



L	Ø min - Max	€	88,00	1	014910050
mm	mm				
500	70 ÷ 200				

## 1492/1 - 1492/2

chaves reguláveis para filtros de óleo



1492/1	60÷80	€	52,50	1	014920001
1492/2	80÷110	€	54,50	1	014920002

## 1492T

chave para filtros de óleo



1492T 40	125÷145	40	€	40,50	1	014920540
1492T 75	120÷140	75	€	71,00	1	014920575

## 1493B

kit chaves bi-sextavadas para filtros de óleo



mm	mm	€	22,70	1	014930524
24	8				
27	8	€	23,70	1	014930527
32	8	€	24,20	1	014930532
36	8	€	26,00	1	014930536
38	8	€	26,50	1	014930538

## 1493

chave para filtros de óleo



Ø	N	€	12,90	1	014930200
mm					
65	14				
73	14	€	12,90	1	014930208
74	14	€	12,90	1	014930209
76	14	€	12,90	1	014930218
76-74	15	€	14,00	1	014930220
78	15	€	14,00	1	014930224
80	15	€	14,30	1	014930226
82-80	15	€	14,30	1	014930228
86	16	€	15,20	1	014930230
100	15	€	17,30	1	014930248
106	15	€	17,90	1	014930250
108	15	€	17,90	1	014930252
135	18	€	29,00	1	014930256

## 1493/PF

chaves filtro de óleo Purflux®

12"



Ø mm	N	€	1	014930202
66	6	12,90	1	014930202
76	12	12,90	1	014930216
76	30	14,00	1	014930222
86	18	15,20	1	014930232
93	36	15,20	1	014930240
93	45	15,20	1	014930242
108	18	19,30	1	014930254

## 1493/C30

jogo de 28 chaves para filtros de óleo

12"



Tamanhos incluídos no jogo (Ø mm / n.º. de lados)  
1493:

65/14 - 68/14 - 73/14 - 74/15  
76/15 - 75.77/15 - 76/14 - 76/8 - 78/15 - 80/15  
82/15 - 86/16 - 90/15 - 92/10 - 93/15 - 95/15  
100/15 - 106/15 - 108/15

1493PF (Purflux)

66/6 - 76/12 - 76/30 - 86/18  
93/36 - 93/45 - 96/18 - 108/18

- Inclui 1 chave ajustável de filtros de óleo  
Ø 65+120 mm

1493/C30	312,00	1	014930000
530x400x110 mm - 4 kg			

## 1493AL

chaves de filtro

N= número de lados

38"

12"



Ø mm	N	•	□	€	1	014930310
64	14	27	½"	19,30	1	014930310
66,5	14	27	½"	17,30	1	014930315
74	14	27	½"	21,00	1	014930320
84	14	27	3/8"	21,00	1	014930330
92	15	27	3/8"	21,00	1	014930340
100,5	15	27	3/8"	21,00	1	014930350

## 1493AL 4S

chaves de filtro  
para veículos de origem asiática  
perfil de 4 ganchos

38"

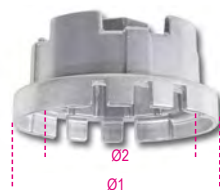

Ø1 mm	Ø2 mm	27	€	1	014930304
70	64,5	27	21,00	1	014930304
80	64,5	27	19,30	1	014930305

## 1493AL CF

chaves de caixa sextavadas  
para cartuchos de filtro

12"



Ø mm	H mm	•	€	1	014930424
24	34	27	12,50	1	014930424
30	34	27	12,50	1	014930430
32,5	34	27	12,90	1	014930432
38	34	27	12,90	1	014930438

## 1493/C19

jogo 18 chaves de filtro de óleo,  
particularmente adequadas para automóveis  
de origem asiática

Ø mm	N.º. de lados
63-64	14
66,5	14
74	14
79	15
84	14
87	16
92	15
94,5	15
100,5	15
64,5	14 chave de gancho para veículos Toyota
64,5	14 chave de gancho para veículos Lexus
6 chaves de caixa sextavadas, tamanhos 24-27-30-32,5-36-38 mm, para cartuchos de filtro	
Kit inclui 1 chave universal ajustável Ø 58+93 mm	

12"

38"



1493/C19	273,00	1	014930019
490x450x60 mm - 4 kg			

## 1493DSG

chave para filtros de óleo DSG

12"

12"



Ø mm	€	1	014930800
24	43,00	1	014930800

## 1493FF/2

chave de filtro de óleo com cabeça de roquete giratória  
permite a remoção/instalação do alojamento em plástico dos filtros de óleo do Grupo PSA e FORD

12"

12"



Ø	L	€	1	014930128
27	245	124,00	1	014930128

## 1493J

chaves para filtros de óleo MultiJet

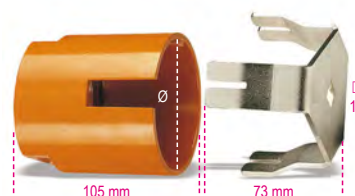

Ø mm	€	1	014930080
90	137,00	1	014930080

## 1493/C7

chave de filtros de regulação automática com três braços cambiáveis, para aperto à esquerda e à direita

Revestimento diamantado anti-derrapante

2 jogos de braços:

- 1 jogo com 20 mm comprimento de trabalho
- 1 jogo com 38 mm comprimento de trabalho

38"



1493/C7	50+100	16	€	1	014930079
210x150x50 mm					



## 1493H

Chave de filtro de óleo autoajustável com 3 braços, para aperto à direita e esquerda  
Mordentes recartilhados

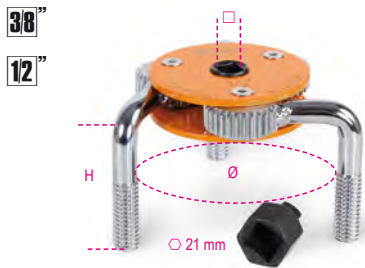

	∅ mm	H mm	€		
1493H	72÷127	62	32,50	1	014930077

## 1493/S-U

chave de ajuste automático para filtros de óleo com 3 braços, para aperto manual direito e esquerdo



	∅ mm	€		
1493/S	3/8-1/2 80-115	99,50	1	014930074
1493/U	1/2 105-165	217,00	1	014930076

## 1493X

chaves de filtro com bloqueio automático, para aperto à esquerda



	∅ mm	± mm	€		
1493X/1	60÷80	2,9	37,50	1	014930105
1493X/2	80÷98	2,9	37,50	1	014930110



## 1493Y

chaves de filtro com bloqueio automático, para aperto à esquerda e à direita, versão para trabalhos pesados

Item 1493Y/2 também pode ser utilizado para filtros de secado



	∅ mm	± mm	€		
1493Y/1	80÷110	7,3	129,00	1	014930120
1493Y/2	104÷145	7,3	196,00	1	014930122

## 1494T/C5

jogo de chaves especiais para bujões de óleo em plástico

Jogo inclui:

- 1 chave para bujões de óleo do grupo VAG
- 1 chave para bujões de óleo BMW
- 1 chave para bujões de óleo grupo PSA e Ford
- 1 chave para bujões de óleo Mercedes
- 1 chave em "T"



	€		
1494T/C5	85,50	1	014940350

173x125x50 mm - 360 g

## 1494BMW

chave especial para bujões do cárter, para motores BMW

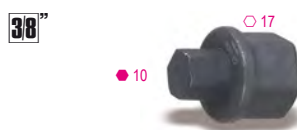

	€		
1494BMW	16,50	1	014940315

## 1494FPC

chave especial para bujões do cárter, para motores Ford, Peugeot e Citroën



	€		
1494FPC	18,70	1	014940320

## 1494VW

chave especial para bujões do cárter, motores Volkswagen

Permite remover e instalar o bujão em plástico do cárter de óleo. Especialmente desenvolvido para veículos Volkswagen com motor TFSI e TDI



	€		
1494VW	26,00	1	014940305

## 1494MRC

chave especial para bujões de óleo em plástico, para motores Mercedes



	€		
1494MRC	18,10	1	014940325

## 1494MAN

chave especial para bujões de óleo em plástico, para motores DAF e MAN



	€		
1494MAN	18,10	1	014940330

## 1494

chave quadra para bujões de óleo



mm	€		
10	10,80	1	014940280

## 1494E

chave macho hexagonal para bujões de óleo



mm	€		
8	10,80	1	014940208
9	10,80	1	014940209
10	10,80	1	014940210
11	10,80	1	014940211
12	10,80	1	014940212
14	10,80	1	014940214
17	10,80	1	014940217

## 1494Q

chave macho quadra para bujões de óleo

12"



mm	€	1	014940258
8	10,80	1	014940258
9,5	10,80	1	014940259
12	10,80	1	014940262
13	10,80	1	014940263

## 1494T

chave macho triangular para bujões

12"



mm	€	1	014940289
9,5	10,80	1	014940289

## 1494XZN

chave macho perfil XZN® para bujões de óleo

12"



M	€	1	014940296
16	12,90	1	014940296

## 1494VW/K

kit para mudança de óleo, para veículos VAG



Contém:  
• 1 chave especial para bujões do cárter  
• 6 chaves para cárter de óleo

1494VW/K	€	1	014940310
	34,00	1	014940310

## 1494VW/KT

kit de 6 tampas de plástico para item 1494VW/K



1494VW/KT	€	1	014940311
	29,50	1	014940311

## 1494/C14A

jogo de 14 ferramentas para muda de óleo

12"



1494/C14A	€	1	014940150
	154,00	1	014940150

- 1494E 8-9-10-11-12-14-17
- 1494Q 8-9,5(3/8")-12-13
- 1494 10
- △ 1494T 9,5(3/8")
- 1494XZN M16

380x305x40 mm - 1,7 kg

## 1494M

chave magnética e flexível para bujões sextavados

Permite remover bujões sem risco de queimaduras para o operador



L mm	F kg	Ø mm	€	1	014940401
293	2,5	19	28,00	1	014940401

## 1495/C6

jogo de ferramentas para reparação de roscas de bujões de óleo



- A rosca danificada é removida por um macho e aumentada uma medida
  - Permite reparar e evitar a substituição do cárter de óleo
- Conteúdo:
- 1 macho M13x1.25 + 6 parafusos + 12 anilhas
  - 1 macho M13x1.5 + 6 parafusos + 12 anilhas
  - 1 macho M15x1.5 + 6 parafusos + 12 anilhas
  - 1 macho M17x1.5 + 6 parafusos + 12 anilhas
  - 1 macho M20x1.5 + 6 parafusos + 12 anilhas
  - 1 macho M22x1.5 + 6 parafusos + 12 anilhas

1495/C6	€	1	014950500
	334,00	1	014950500

420x185x60 mm - 2,1 kg

## 1495M

macho para roscas de bujon



M	€	1	014950553
13x1,25	20,10	1	014950553
13x1,50	16,50	1	014950563
15x1,50	17,90	1	014950565
17x1,50	20,10	1	014950567
20x1,50	22,20	1	014950570
22x1,50	29,00	1	014950572

## 1495T

jogo 6 bujons e anilhas



M	€	1	014950503
13x1,25	23,50	1	014950503
13x1,50	23,50	1	014950513
15x1,50	23,50	1	014950515
17x1,50	26,00	1	014950517
20x1,50	29,50	1	014950520
22x1,50	38,00	1	014950522

## 1496/C

chave para bujões de óleo



8 x 10 mm	€	3	014960010
	25,50	3	014960010

## 1497D

Alicate para remoção de relays, pontas direitas

Permite a remoção fácil de todos os tipos de relays, sem o risco de os partir



A min+Max mm	€	1	014970150
15÷50	38,50	1	014970150

## 1497BS

alicates para remoção de relés e fusíveis, pontas direitas, corpo estreito

as pontas longas e extremamente finas permitem remover o relé e o fusível em pequenas áreas



L	L1	A	€	1	014970190
mm	mm	mm			
230	45	14	27,00	1	014970190

## 1497P

Alicate para remoção de relays, pontas angulares, 60°

Permite a remoção fácil de todos os tipos de relays, sem o risco de os partir



A	€	1	014970160
min+Max			
mm			
15÷50	40,00	1	014970160

## 1497SS

alicates de pressão para soldadura de fios estanhados

Os cliques superiores permitem que os fios a soldar sejam presos e aproximados uns dos outros.

A cremalheira incluída permite colocar os fios em 6 posições diferentes



L	A	€	1	014970195
mm	min+Max			
245	mm			
	14÷70	24,50	1	014970195

## 1497TE

alicate para conectores elétricos

as extremidades muito finas permitem soldar os clips sem danificar os conectores



L	A	Ø	€	1	014970180
mm	mm	mm			
215	63	4	28,00	1	014970180



## 1497/C23

Sortido 23 ferramentas para remoção de terminais eléctricos



1497/C23	€	1	014970200
	261,00	1	014970200
440x250x70 mm - 1,7 kg			

## 1497/C94

sortido de 94 conectores de teste auto para utilização com as principais ferramentas de diagnóstico

- 2 machos em T
- 2 potenciômetros
- 2 luzes de aviso
- 2 conectores SRS
- 2 pinças
- 2 sondas de agulha
- 2 pinças para extracção de terminais
- 2 conectores tipo banana duplos
- 4 conectores tipo banana single
- 24 terminais tipo lingueta macho 0.6÷6 mm
- 12 terminais redondos macho 1.6÷3.9 mm
- 24 terminais tipo lingueta fêmea 0.6÷6 mm
- 12 terminais redondos fêmea 1.6÷3.9 mm



1497/C94	€	1	014970300
	459,00	1	014970300
430x390x100 mm - 3 kg			

## 1497RC

Pinças para cabos rouba corrente, par

- secção do cabo: 1.5÷3.5 mm
- voltagem: 0÷330V
- corrente máx.: 5A



1497RC	€	1	014970351
	87,50	1	014970351

## 1498

verificador de tensão

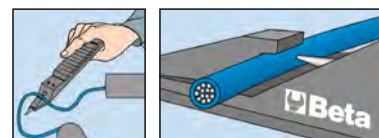

3÷48V	€	2	014980100
	58,00	2	014980100





# REPARAÇÃO DE VEÍCULOS

As nossas ferramentas para reparação de veículos, usadas pelos profissionais mais exigentes, são desenvolvidas e fabricadas para cumprir as normas mais rígidas a nível mundial, e são testadas com regularidade sob as mais difíceis condições de trabalho. Há mais de 50 anos que temos o orgulho de trabalhar de mãos dadas com os melhores, que nos ajudam a melhorar continuamente os nossos produtos e são testemunhas dos mais elevados padrões de qualidade.

**As ferramentas de reparação de veículos encontram-se nas seguintes secções:**

<b>Diagnóstico</b>
itens 1464T/N a 1465 - itens 1498SM a 1499 itens 1758VT a 1760/IR 1600
<b>Motor</b>
itens 955 a 960SN - itens 1440 a 1462/KEP itens 1472 a 1485TC - itens 1737 a 1759TT
<b>Óleo e filtros</b>
itens 1488/1 a 1496/C itens 1877 a 1889N
<b>Sistema elétrico</b>
itens 1489/33 a 1489Y itens 1497D a 1497RC
<b>Arrancadores</b>
itens 1498BC/12 a 1498DG1100E
<b>Transmissão</b>
itens 1884 a 1885/X C60 - itens 1438 a 1438DSG itens 1566N a 1569/F

<b>Suspensão</b>
itens 1550U a 1567
<b>Travões</b>
itens 1466/C5 a 1471T/C5
<b>Rodas</b>
itens 720MRC a 729T - itens 962 a 989B itens 1530/C5 a 1531/C7
<b>Carroçaria</b>
itens 1065F5 a 1068 - itens 1302 a 1369/C11 itens 1478 a 1479U/32- itens 1505V a 1539 itens 1763 a 1768
<b>Outros equipamentos</b>
itens 1875LT a 3067
<b>Elevação</b>
itens 3006 a 3069

## 1498BC/12

arrancador de baterias portátil multiusos, 12V

Características técnicas:

- Corrente de arranque: 600A
- Pico da corrente de arranque: 1500A
- Tipo de bateria: 4 células, LifePo4
- Capacidade da bateria: 25000mAh
- Dispositivo de proteção contra inversão de polaridade, curto-circuito, sobretensão, sobrecarga e sobreaquecimento



CE



Fornecido com:

- Capa de proteção
- Cabos de arranque com grampos
- Portas USB para carregar dispositivos eletrónicos
- LED indicador de carga da bateria
- Cabo USB e USB-C
- Fonte de alimentação principal
- Lanterna LED multifunções

## ARRANCADORES, CARREGADORES DE BATERIA E APARELHOS DE TESTE

**Beta**  
CHARGING

Após a aquisição do fabricante especializado Helvi, a Beta Utensili lançou uma nova linha de arrancadores, carregadores de bateria e aparelhos de teste, sinónimo de excelente desempenho e padrões de qualidade.

A gama inclui arrancadores portáteis para veículos ligeiros e pesados, carregadores de baterias convencionais e eletrónicos - incluindo os de rodas - e aparelhos de teste de baterias.

A Beta conta com as competências de fabrico da Helvi para oferecer uma gama cada vez mais abrangente e especializada, para responder às necessidades dos profissionais mais exigentes.



	L	P	H	€	1	014980040
1498BC/12	225	100	40	382,00		

## 1498MN/12-C

cabos de arranque com grampos para artigo 1498BC/12



	€	1	014980005
1498MN/12-C	68,50		

## 1498MN/12-R

Dispositivo de alimentação para mini arrancadores 1498BC/12



	€	1	014980003
1498MN/12-R	50,50		

## 1498MN/12-P

Dispositivo de alimentação para mini arrancadores 1498BC/12



1498MN/12-P € 30,50 1 014980004

## 1498LT/12

arrancador de baterias portátil de alta performance, ultra leve



CE



Voltagem: 12 V  
Amperagem contínua: 800 A  
Amperagem máx. de arranque: 2000 A  
Pico de amperagem: 4000 A  
Comprimento do cabo: 500 mm  
Tipo de bateria: 4 células LifePo4  
Função de memorização: SIM  
Dimensões: 260 x 135 x 72 mm  
Peso: 2,5 kg  
Com carregador 12 V 1.3A  
Proteção eletrônica: SIM

1498LT/12 € 975,00 1 014980012

## 1498LT/12-SF

suporte de parede para arrancador 1498LT/12



1498LT/12-SF € 162,00 1 014980013

## 1498LT/12-R7

Arrancador portátil alta performance, ultraleve 1498LT/12



1498LT/12-R7 € 70,50 1 014980657

## 1498LT/12-24

arrancador portátil de alta performance, 12-24 V, ultra leve,

adequado para veículos ligeiros, comerciais e pesados



CE



O microprocessador oferece proteção total contra:

- inversão de polaridade
- curto circuitos
- tensão incorreta
- sobrecargas
- descarga insuficiente
- sobreaquecimento

CARACTERÍSTICAS TÉCNICAS

- voltagem de trabalho: 12/24V
- Amperagem contínua: 2000/1000 A
- amperagem máx. de arranque: 5000/2500 A
- pico de amperagem: 10000/5000 A
- amperagem do grampo: 1000 A
- comprimento do cabo: 160 cm
- secção do cabo: 25mm<sup>2</sup>
- fonte de alimentação automática: 4 Amp
- função de memória
- dimensões: 350x240x140 mm
- peso: 5 kg

1498LT/12-24 € 1.930,00 1 014980014



## 1498EL/12

arrancador portátil para automóveis, 12V

- para todos os automóveis GT e económicos, 12V, gasolina ou gasóleo
- carga através de alimentador eletrônico automático
- carga através da tomada de isqueiro
- fusível de proteção interno
- indicador LED do estado de carga da bateria
- alça incluída
- bateria de chumbo-ácido blindada (AGM)



CE



Especificações técnicas:

- Pico de corrente de arranque: 1800A
- Capacidade da bateria: 22 Ah
- Comprimento do cabo: 1 m
- Peso: 9,8 kg

H mm 330 L mm 390 P mm 130 € 565,00 1 014980712

## 1498EL/12-24

arrancador portátil para automóveis e veículos comerciais, 12/24V

- para todos os automóveis e veículos comerciais com baterias 12V
- carga através de alimentador eletrônico automático
- carga através da tomada de isqueiro
- fusível de proteção interno
- indicador LED do estado de carga da bateria
- alça incluída
- bateria de chumbo-ácido blindada (AGM)



CE



Características técnicas:

- Pico de corrente de arranque: 3600A 12V - 1800A 24V
- Capacidade da bateria: 2x 22 Ah
- Comprimento do cabo: 2 m
- Peso: 18,5 kg

H mm 330 L mm 390 P mm 180 € 1.080,00 1 014980724



## 1498EL/12-R01

bateria de substituição, 12V, para arrancadores EL/12V e EL/12-24V

CE



1498EL/12-R01 € 197,00 1 014980713

## 1498/12-24 R20

fonte de alimentação para arrancadores itens 1498/12 e 1498/24



1498/12-24 R20 € 85,50 1 014980520

## 1498PRO/12

arrancador portátil para automóveis, 12V, Pro

- para todos os automóveis GT e económicos, 12V, gasolina ou gasóleo
- ecrã gráfico com amperímetro e indicação do estado de carga
- carga através de alimentador eletrónico automático
- carga através da tomada de isqueiro
- fusível de proteção interno
- alça incluída
- bateria de chumbo-ácido blindada (AGM)

CE

DISPONÍVEL A PARTIR DE JUNHO



Especificações técnicas:

- Pico de corrente de arranque: 3200A
- Capacidade da bateria: 25 Ah
- Comprimento do cabo: 2 m
- Peso: 15.8 kg

L mm 255 P mm 210 H mm 380 € 765,00 1 014980812

## 1498PRO/12-R01

bateria de substituição, 12V, para arrancadores 1498PRO/12V



C58K/4PF-2,1M € 382,00 1 014980813

## 1498PRO/12-24

arrancador portátil para automóveis, 12/24V, Pro

- para todos os tipos de veículos com baterias de 12V ou 24V
- ecrã gráfico com amperímetro e indicação do estado de carga
- carga através de alimentador eletrónico automático
- carga através da tomada de isqueiro
- fusível de proteção interno
- alça incluída
- bateria de chumbo-ácido blindada (AGM)

CE

DISPONÍVEL A PARTIR DE JUNHO



Características técnicas:

- Pico de corrente de arranque: 5000A 12V - 2500A 24V
- Capacidade da bateria: 2 x 18 Ah
- Comprimento do cabo: 2 m
- Peso: 19.8 kg

L mm 255 P mm 210 H mm 380 € 1.530,00 1 014980824

## 1498PRO/12-24 R01

bateria de substituição, 12V, para arrancadores 1498PRO/12-24V



C58K/4PF-2,1M € 169,00 1 014980825

## 1498/2A

Carregador eletrónico de baterias de motos, 12V

Permite o carregamento de todos os tipos de bateria Pb Wet, Agm, Gel, Mf e Vrla e baterias de lítio LiFePo4.

12V  
2Ah - 40Ah



CE



IP65



- Dois tipos de carga diferentes, para lítio e bateria de chumbo ácido, respetivamente
- Ciclo de carga automático multi-estágios
- Proteção contra inversão de polaridade e curtos circuitos
- Grau de proteção IP65
- Fornecido com cabo, grampos e cabo com olhais
- Voltagem: 220-240V

CARACTERÍSTICAS TÉCNICAS:

- Corrente de carga: 1A
- Capacidade de carga: 2Ah-40Ah
- Frequência: 50-60 Hz
- Voltagem: 12V
- Dimensões: 180x80x40 mm
- Peso: 0.5 kg

1498/2A € 151,00 1 014980102

## 1498SA/2A-4A

Cabo com ligação a isqueiro para os artigos 1498 / 2A e 1498 / 4A



1498SA/2A-4A € 38,00 1 014980120

## 1498/4A-8A CO

cabo com olhal para artigos 1498/4A e 8A



1498/4A-8A-CO € 18,50 1 014980114

## 1498/4A-8A CP

cabo com grampos para artigos 1498/4A e 8A



1498/4A-8A-CP € 23,70 1 014980118

## 1498/2A-8A-PR

extensão para item 1498/2A/4A/8A



1498/2A-8A-PR € 44,00 1 014980119





## 1498H/4A

carregador eletrônico multifunções de baterias, 6-12V

Características:

- Ecrã LCD
- Luz LED com 3 intensidades
- Carga e manutenção da carga
- Proteção contra inversão de polaridade, curto-circuitos, sobreaquecimento e sobrecarga
- Proteção contra faíscas
- 9 níveis de carga
- Sistema flutuante
- Funções: recuperação, teste e dessulfatação de baterias
- Suporte para grampo
- Gancho de fixação reclinável
- Acessórios fornecidos: cabo com grampo, cabo com ilhós

6-12V  
5Ah - 120Ah



IP65



Características técnicas:

- Potência: 230V - 50/60Hz
- Corrente de carga: 1-4A
- Tipos de baterias: Pb - GEL - Ca/Ca - AGM - Start/Stop - Lithium (LiFePO4)
- Capacidade de carga: 5-80Ah (LiFePO4 1-80Ah)
- Capacidade de manutenção: 5-120Ah (LiFePO4 1-120Ah)
- Voltagem de saída: 6-12V
- Grau de proteção: IP65

L	P	H	€		
mm	mm	mm			
181	91	58	175,00	1	014980204

## 1498H/16A

carregador eletrônico multifunções de baterias, 12-24V

Características:

- Ecrã LCD
- Luz LED com 3 intensidades
- Carga e manutenção da carga
- Proteção contra inversão de polaridade, curto-circuitos, sobreaquecimento e sobrecarga
- Proteção contra faíscas
- 9 níveis de carga
- Sistema flutuante
- Funções: recuperação, teste e dessulfatação de baterias
- Suporte para grampo
- Gancho de fixação reclinável
- Acessórios fornecidos: cabo com grampo, cabo com ilhós

12-24V  
20Ah - 550Ah



IP20

Características técnicas:

- Potência: 230V - 50/60Hz
- Corrente de carga: 4-16A
- Tipos de baterias: Pb - GEL - Ca/Ca - AGM - Start/Stop - Lithium (LiFePO4)
- Capacidade de carga: 20-360Ah (LiFePO4 4-360Ah)
- Capacidade de manutenção: 20-550Ah (LiFePO4 4-550Ah)
- Alimentação (DC): 13.8V - 12A
- Voltagem de saída: 12-24V
- Grau de proteção: IP20

L	P	H	€		
mm	mm	mm			
298	152	88	317,00	1	014980216

## 1498H/25A

carregador eletrônico multifunções de baterias, 12-24V

Características:

- Ecrã LCD
- Luz LED com 3 intensidades
- Carga e manutenção da carga
- Proteção contra inversão de polaridade, curto-circuitos, sobreaquecimento e sobrecarga
- Proteção contra faíscas
- 9 níveis de carga
- Sistema flutuante
- Funções: recuperação, teste e dessulfatação de baterias
- Suporte para grampo
- Gancho de fixação reclinável
- Acessórios fornecidos: cabo com grampo, cabo com ilhós

12-24V  
30Ah - 800Ah



IP20

Características técnicas:

- Potência: 230V - 50/60Hz
- Corrente de carga: 6-24A
- Tipos de baterias: Pb - GEL - Ca/Ca - AGM - Start/Stop - Lithium (LiFePO4)
- Capacidade de carga: 30-550Ah (LiFePO4 6-550Ah)
- Capacidade de manutenção: 30-800Ah (LiFePO4 6-800Ah)
- Alimentação (DC): 13.8V - 20A
- Voltagem de saída: 12-24V
- Grau de proteção: IP20

L	P	H	€		
mm	mm	mm			
298	152	88	338,00	1	014980225

## 1498H/8A

carregador eletrônico multifunções de baterias, 12-24V

Características:

- Ecrã LCD
- Luz LED com 3 intensidades
- Carga e manutenção da carga
- Proteção contra inversão de polaridade, curto-circuitos, sobreaquecimento e sobrecarga
- Proteção contra faíscas
- 9 níveis de carga
- Sistema flutuante
- Funções: recuperação, teste e dessulfatação de baterias
- Suporte para grampo
- Gancho de fixação reclinável
- Acessórios fornecidos: cabo com grampo, cabo com ilhós

12-24V  
10Ah - 250Ah



IP65

Características técnicas:

- Potência: 230V - 50/60Hz
- Corrente de carga: 2-8A
- Tipos de baterias: Pb - GEL - Ca/Ca - AGM - Start/Stop - Lithium (LiFePO4)
- Capacidade de carga: 10-160Ah (LiFePO4 2-160Ah)
- Capacidade de manutenção: 10-250Ah (LiFePO4 2-250Ah)
- Alimentação (DC): 13.8V - 5A
- Voltagem de saída: 12-24V
- Grau de proteção: IP65

L	P	H	€		
mm	mm	mm			
223	112	68	215,00	1	014980208



## 1498/PR14

carregador de baterias, 6/12V

Características:

- Para baterias de chumbo-ácido
- Seletores de voltagem/corrente
- Amperímetro
- Proteção contra sobrecarga térmica automática
- Proteção contra inversão de polaridade



Características técnicas:

- Fonte de alimentação (1ph): 230 V - 50/60 Hz
- Potência: 140 W
- Voltagem: 6/12 V
- Corrente máxima: 11 A
- Corrente de carga: 7.5 A
- Capacidade de carga: 112 Ah 15h
- Posições de carga: 2

L	P	H	€		
mm	mm	mm			
260	200	175	154,00	1	014980730

## 1498/PR17

carregador de baterias, 12/24V

### Características:

- Para baterias de chumbo-ácido
- Seletores de voltagem/corrente
- Amperímetro
- Proteção contra sobrecarga térmica automática
- Proteção contra inversão de polaridade



CE

### Características técnicas:

- Fonte de alimentação (1ph): 230 V - 50/60 Hz
- Potência: 300 W
- Voltagem: 12/24 V
- Corrente máxima: 12,5 A
- Corrente de carga: 8,5 A
- Capacidade de carga: 128 Ah 15h
- Posições de carga: 2

L	P	H	€	1	014980731
mm	mm	mm			
260	200	175	171,00		

## 1498/PR25

carregador de baterias, 6/12/24 V

### Características:

- Para estações de carga de grandes dimensões
- Para baterias de chumbo-ácido
- Seletores de voltagem/corrente
- Amperímetro
- Proteção térmica automática



CE

### Características técnicas:

- Fonte de alimentação (1ph): 230 V - 50/60 Hz
- Potência: 620 W
- Voltagem: 6/12/24 V
- Corrente máxima: 25 A
- Corrente de carga: 17 A
- Capacidade de carga: 255 Ah 15h
- Posições de carga: 6

L	P	H	€	1	014980733
mm	mm	mm			
250	245	435	457,00		

## 1498/AM30

carregador de baterias automático 12/24 V

### Características:

- Para baterias AGM, GEL, chumbo-ácido e Start/Stop
- Controlo eletrónico da corrente de carga
- Indicadores luminosos do estado de carga
- Regulação da corrente de carga através de potenciômetro
- Função de carga automática
- Função de manutenção



CE

### Características técnicas:

- Fonte de alimentação (1ph): 230 V - 50/60 Hz
- Potência: 720 W
- Voltagem: 12/24 V
- Corrente máxima: 30 A
- Corrente de carga: 20 A
- Capacidade de carga: 300 Ah 15h
- Posições de carga: ∞

L	P	H	€	1	014980740
mm	mm	mm			
220	235	335	650,00		

## 1498/PR20

carregador de baterias, 12/24V

### Características:

- Para baterias de chumbo-ácido
- Seletores de voltagem/corrente
- Amperímetro
- Proteção contra sobrecarga térmica automática
- Proteção contra inversão de polaridade



CE

### Características técnicas:

- Fonte de alimentação (1ph): 230 V - 50/60 Hz
- Potência: 390 W
- Voltagem: 12/24 V
- Corrente máxima: 16 A
- Corrente de carga: 11 A
- Capacidade de carga: 165 Ah 15h
- Posições de carga: 2

L	P	H	€	1	014980732
mm	mm	mm			
260	200	175	229,00		

## 1498/PR35B

carregador de baterias, 6/12/24/36/48 V

### Características:

- Para estações de carga de grandes dimensões
- Para baterias de chumbo-ácido
- Seletores de voltagem/corrente
- Amperímetro
- Proteção térmica automática



CE

### Características técnicas:

- Fonte de alimentação (1ph): 230 V - 50/60 Hz
- Potência: 1830 W
- Voltagem: 6/12/24/36/48 V
- Corrente máxima: 38 A
- Corrente de carga: 25 A
- Capacidade de carga: 375 Ah 15h
- Posições de carga: 12

L	P	H	€	1	014980734
mm	mm	mm			
250	245	435	865,00		

## 1498/SP150

carregador/arrancador de baterias, 12 V

### Características:

- Para baterias de chumbo-ácido
- Seletor de corrente de carga
- Amperímetro
- Protetor termostático de arranque longo
- Fusível de proteção contra curto-circuitos
- Proteção contra inversão de polaridade



CE

### Características técnicas:

- Fonte de alimentação (1ph): 230 V - 50/60 Hz
- Potência: 190 W
- Voltagem: 12 V
- Corrente máxima: 15 A
- Corrente de carga: 11 A
- Corrente de impulso máxima: 120 Acc
- Corrente de arranque: 85 A
- Capacidade de carga: 165 Ah 15h
- Posições de carga: 2 + boost

L	P	H	€	1	014980745
mm	mm	mm			
260	200	175	218,00		

## 1498/SP250

carregador/arrancador de baterias, 12/24 V

### Características:

- Para baterias de chumbo-ácido
- Seletor de corrente de carga
- Amperímetro
- Protetor termostático de arranque longo
- Fusível de proteção contra curto-circuitos
- Proteção contra inversão de polaridade



CE

### Características técnicas:

- Fonte de alimentação (1ph): 230 V - 50/60 Hz
- Potência: 650 W
- Voltagem: 12/24 V
- Corrente máxima: 27 A
- Corrente de carga: 18 A
- Corrente de impulso máxima: 200 Acc
- Corrente de arranque: 135 A
- Capacidade de carga: 270 Ah 15h
- Posições de carga: 2 + boost

L	P	H	€		
mm	mm	mm			
220	235	335	346,00	1	014980746

## 1498/RP480

carregador/arrancador de baterias, 12/24 V

### Especificações:

- Para baterias de chumbo-ácido
- Seletor de corrente de carga
- Amperímetro
- Protetor termostático de arranque longo
- Fusível de proteção contra curto-circuitos
- Proteção contra inversão de polaridade



CE

### Especificações técnicas:

- Fonte de alimentação (1ph): 230 V - 50/60 Hz
- Potência: 1320 W
- Voltagem: 12/24 V
- Corrente máxima: 55 A
- Corrente de carga: 36 A
- Corrente de impulso máxima: 450 Acc
- Corrente de arranque: 315 A
- Capacidade de carga: 450 Ah 15h
- Posições de carga: 6 + boost

L	P	H	€		
mm	mm	mm			
250	245	435	635,00	1	014980751

## 1498/SC441

carregador/arrancador de baterias, 12/24 V, com rodas

### Especificações:

- Para baterias de chumbo-ácido
- Seletor de corrente de carga lenta/rápida
- Amperímetro
- Protetor termostático de arranque longo
- Fusível de proteção contra curto-circuitos
- Proteção contra inversão de polaridade



CE

### Especificações técnicas:

- Fonte de alimentação (1ph): 230 V - 50/60 Hz
- Potência: 1320 W
- Voltagem: 12/24 V
- Corrente máxima: 55 A
- Corrente de carga: 36 A
- Corrente de reforço máxima: 380 Acc
- Corrente de arranque: 260 A
- Capacidade de carga: 450 Ah 15h
- Posições de carga: 3 + boost

L	P	H	€		
mm	mm	mm			
260	395	770	565,00	1	014980756

## 1498/RP380

Carregador/arrancador de baterias, 12/24 V

### Características:

- Para baterias de chumbo-ácido
- Seletor de corrente de carga
- Amperímetro
- Protetor termostático de arranque longo
- Fusível de proteção contra curto-circuitos
- Proteção contra inversão de polaridade



CE

### Características técnicas:

- Fonte de alimentação (1ph): 230 V - 50/60 Hz
- Potência: 900 W
- Voltagem: 12/24 V
- Corrente máxima: 38 A
- Corrente de carga: 25 A
- Corrente de impulso máxima: 280 Acc
- Corrente de arranque: 200 A
- Capacidade de carga: 270 Ah 15h
- Posições de carga: 2 + boost

L	P	H	€		
mm	mm	mm			
220	235	335	457,00	1	014980750

## 1498/SC341

carregador/arrancador de baterias, 12/24 V, com rodas

### Especificações:

- Para baterias de chumbo-ácido
- Seletor de corrente de carga
- Amperímetro
- Protetor termostático de arranque longo
- Fusível de proteção contra curto-circuitos
- Proteção contra inversão de polaridade



CE

### Especificações técnicas:

- Fonte de alimentação (1ph): 230 V - 50/60 Hz
- Potência: 1080 W
- Voltagem: 12/24 V
- Corrente máxima: 45 A
- Corrente de carga: 30 A
- Corrente de impulso máxima: 340 Acc
- Corrente de arranque: 200 A
- Capacidade de carga: 375 Ah 15h
- Posições de carga: 3 + boost

L	P	H	€		
mm	mm	mm			
260	395	770	520,00	1	014980755

## 1498/SC540

carregador/arrancador de baterias, 12/24 V, com rodas

### Especificações:

- Para baterias de chumbo-ácido
- Seletor de corrente de carga lenta/rápida
- Amperímetro
- Protetor termostático de arranque longo
- Fusível de proteção contra curto-circuitos
- Proteção contra inversão de polaridade
- Temporizador de carga



CE

### Especificações técnicas:

- Fonte de alimentação (1ph): 230 V - 50/60 Hz
- Potência: 1440 W
- Voltagem: 12/24 V
- Corrente máxima: 60 A
- Corrente de carga: 40 A
- Corrente de reforço máxima: 480 Acc
- Corrente de arranque: 330 A
- Capacidade de carga: 525 Ah 15h
- Posições de carga: 6 + boost

L	P	H	€		
mm	mm	mm			
350	465	840	770,00	1	014980757



## 1498/SC640

carregador/arrancador de baterias, 12/24 V, com rodas

Especificações:

- Para baterias de chumbo-ácido
- Seletor de corrente de carga lenta/rápida
- Amperímetro
- Protetor termostático de arranque longo
- Fusível de proteção contra curto-circuitos
- Proteção contra inversão de polaridade
- Temporizador de carga

CE



Especificações técnicas:

- Fonte de alimentação (1ph): 230 V - 50/60 Hz • Potência: 1800 W
- Voltagem: 12/24 V
- Corrente máxima: 75 A
- Corrente de carga: 50 A
- Corrente de reforço máxima: 550 Acc
- Corrente de arranque: 400 A
- Capacidade de carga: 600 Ah 15h
- Posições de carga: 6 + boost

L	P	H	€	1	014980758
mm	mm	mm			
350	465	840	850,00	1	014980758

## 1498/AT500

carregador/arrancador de baterias, 12/24 V

Equipado com a tecnologia CPS (car protection system), que permite ativar e desativar a função boost de forma totalmente automática, para proteger os componentes eletrônicos do veículo.

Especificações:

- Para baterias de chumbo-ácido
- Seletor de corrente de carga
- Amperímetro
- Protetor termostático de arranque longo
- Fusível de proteção contra curto-circuitos
- Proteção contra inversão de polaridade

CE



Especificações técnicas:

- Fonte de alimentação (1ph): 230 V - 50/60 Hz
- Potência: 890 W
- Voltagem: 12/24 V
- Corrente máxima: 37 A
- Corrente de carga: 30 A
- Corrente de reforço máxima: 450 Acc
- Corrente de arranque: 320 A
- Capacidade de carga: 540 Ah 15h
- Posições de carga: 6 + boost

L	P	H	€	1	014980761
mm	mm	mm			
250	345	280	660,00	1	014980761

## 1498/AT701

carregador/arrancador de baterias, 12/24 V, com rodas

Equipado com a tecnologia CPS (car protection system), que permite ativar e desativar a função boost de forma totalmente automática, para proteger os componentes eletrônicos do veículo.

Especificações:

- Para baterias de chumbo-ácido
- Seletor de corrente de carga
- Amperímetro
- Protetor termostático de arranque longo
- Fusível de proteção contra curto-circuitos
- Proteção contra inversão de polaridade

CE



## 1498/AT300

carregador/arrancador de baterias, 12 V

Equipado com a tecnologia CPS (car protection system), que permite ativar e desativar a função boost de forma totalmente automática, para proteger os componentes eletrônicos do veículo.

Especificações:

- Para baterias de chumbo-ácido
- Seletor de corrente de carga
- Amperímetro
- Protetor termostático de arranque longo
- Fusível de proteção contra curto-circuitos
- Proteção contra inversão de polaridade

CE



Especificações técnicas:

- Fonte de alimentação (1ph): 230 V - 50/60 Hz
- Potência: 300 W
- Voltagem: 12 V
- Corrente máxima: 25 A
- Corrente de carga: 20 A
- Corrente de reforço máxima: 300 Acc
- Corrente de arranque: 210 A
- Capacidade de carga: 375 Ah 15h
- Posições de carga: 2 + boost

L	P	H	€	1	014980760
mm	mm	mm			
250	345	280	540,00	1	014980760

## 1498/AT1001

carregador/arrancador de baterias, 12/24 V, com rodas

Equipado com a tecnologia CPS (car protection system), que permite ativar e desativar a função boost de forma totalmente automática, para proteger os componentes eletrônicos do veículo.

Especificações:

- Para baterias de chumbo-ácido
- Seletor de corrente de carga
- Amperímetro
- Protetor termostático de arranque longo
- Fusível de proteção contra curto-circuitos
- Proteção contra inversão de polaridade

CE



Especificações técnicas:

- Fonte de alimentação (1ph): 230 V - 50/60 Hz
- Potência: 2200 W
- Voltagem: 12/24 V
- Corrente máxima: 90 A
- Corrente de carga: 60 A
- Corrente de reforço máxima: 980 Acc
- Corrente de arranque: 560 A
- Capacidade de carga: 1350 Ah 15h
- Posições de carga: 14 + boost

L	P	H	€	1	014980763
mm	mm	mm			
350	465	840	1.730,00	1	014980763

## 1498/AT1300

carregador/arrancador de baterias, 12/24 V, com rodas

Equipado com a tecnologia CPS (car protection system), que permite ativar e desativar a função boost de forma totalmente automática, para proteger os componentes eletrônicos do veículo.

Especificações:

- Para baterias de chumbo-ácido
- Seletor de corrente de carga
- Amperímetro
- Protetor termostático de arranque longo
- Fusível de proteção contra curto-circuitos
- Proteção contra inversão de polaridade

CE



Especificações técnicas:

- Fonte de alimentação (1ph): 230 V - 50/60 Hz
- Potência: 2900 W
- Voltagem: 12/24 V
- Corrente máxima: 120 A
- Corrente de carga: 80 A
- Corrente de reforço máxima: 1280 Acc
- Corrente de arranque: 850 A
- Capacidade de carga: 1800 Ah 15h
- Posições de carga: 12 + boost

L	P	H	€	1	014980764
mm	mm	mm			
575	330	770	2.970,00	1	014980764

## 1498/AT2000

carregador/arrancador de baterias, 12/24 V, com rodas

Equipado com a tecnologia CPS (car protection system), que permite ativar e desativar a função boost de forma totalmente automática, para proteger os componentes eletrônicos do veículo.

### Especificações:

- Para baterias de chumbo-ácido
- Seletor de corrente de carga
- Amperímetro
- Protetor termostático de arranque longo
- Fusível de proteção contra curto-circuitos
- Proteção contra inversão de polaridade



CE

### Especificações técnicas:

- Fonte de alimentação (1ph): 230 V - 50/60 Hz
- Potência: 3600 W
- Voltagem: 12/24 V
- Corrente máxima: 150 A
- Corrente de carga: 120 A
- Corrente de reforço máxima: 2000 Acc
- Corrente de arranque: 1100 A
- Capacidade de carga: 2250 Ah 15h
- Posições de carga: 12 + boost

L	P	H	€		
mm	mm	mm			
575	330	770	4.190,00	1	014980765

## 1498/DG540E

carregador/arrancador de baterias eletrônico, 12/24 V, com rodas

Equipado com a tecnologia CPS (car protection system), que permite ativar e desativar a função boost de forma totalmente automática, para proteger os componentes eletrônicos a bordo do veículo.

### Especificações:

- Para baterias de chumbo-ácido, AGM, gel, Ca/Ca e Start/Stop
- Controlo eletrónico da carga através de microprocessador
- Definição do tempo de carga
- Ecrã digital
- Indicadores LED do estado de carga
- Sistema de controlo para: inversão de polaridade, sobrecorrente, indicação de falha da bateria, arranque seguro, arranque protegido



CE

### Especificações técnicas:

- Fonte de alimentação (1ph): 230 V - 50/60 Hz
- Potência: 1320 W
- Voltagem: 12/24 V
- Corrente máxima: 55 A
- Corrente de carga: 36 A
- Corrente de reforço máxima: 380 Acc
- Corrente de arranque: 260 A
- Capacidade de carga: 810 Ah 15h
- Posições de carga: 4 + boost

L	P	H	€		
mm	mm	mm			
395	260	770	1.040,00	1	014980770

## 1498/DG1100E

carregador/arrancador de baterias eletrônico, 12/24 V, com rodas

Equipado com a tecnologia CPS (car protection system), que permite ativar e desativar a função boost de forma totalmente automática, para proteger os componentes eletrônicos a bordo do veículo.

### Especificações:

- Para baterias de chumbo-ácido, AGM, gel, Ca/Ca e Start/Stop
- Controlo eletrónico da carga através de microprocessador
- Definição do tempo de carga
- Ecrã digital
- Indicadores LED do estado de carga
- Sistema de controlo para: inversão de polaridade, sobrecorrente, indicação de falha da bateria, arranque seguro, arranque protegido



CE

### Especificações técnicas:

- Fonte de alimentação (1ph): 230 V - 50/60 Hz
- Potência: 24000 W
- Voltagem: 12/24 V
- Corrente máxima: 100 A
- Corrente de carga: 70 A
- Corrente de reforço máxima: 580 Acc
- Corrente de arranque: 400 A
- Capacidade de carga: 5000 Ah 15h
- Posições de carga: 4 + boost + supply

L	P	H	€		
mm	mm	mm			
465	350	840	1.380,00	1	014980771

## 1498SM

bateria auxiliar, 12 V

Evita a perda de informação do computador de bordo durante trabalhos de manutenção ou substituição da bateria.



CE



### Características técnicas:

- auto-alimentada
- bateria interna Pb 5 Ah
- 12 volts
- ligação profissional com tomada OBD

	€		
1498SM	292,00	1	014980020

## 1498TB/12-24N

teste digital de baterias, 12-24 V, com impressora integrada

- permite realizar testes em: baterias, alternadores, arrancadores e sistemas
- proteção contra inversão de polaridade
- inclui software para ligação a PC
- display retroiluminado
- compacto, revestimento anti-impacto
- software em 9 idiomas



CE

### Características Técnicas:

- Aplicações - teste de baterias 12-24V
- Intervalo de trabalho: 100-2000 CCA
- Normas de referência: CCA,SAE,DIN,EN,IEC,JIS, MCA, GB, BCI, CA
- Baterias compatíveis: PB, WET, GEL, AGM, AGM FLAT, EFB, SLI
- Voltímetro 9V-30V
- Comprimento do cabo 1800 mm
- Idiomas: Italiano, Inglês, Francês, Alemão, Espanhol, Polaco, Holandês, Húngaro e Português
- Acessórios incluídos: cabo USB, 3 rolos de papel para impressora

	€		
1498TB/12-24N	404,00	1	014980402

## 1498TB/6-12

aparelho analógico teste de baterias, 6-12V

para testar baterias de 6V e 12V até 1000CCA



Comp. cabo: 500 mm

L	L1	P	€		
mm	mm	mm			
290	170	75	68,00	1	014980420

## 1498ST/TB ROT

recarga de papel para testador 1498TB/12-24N



	€		
1498ST/TB ROT	13,60	2	014980411

## 1498PC

estabilizador de voltagem, 12-24 V

Protege unidades de controlo em processos de soldadura e arranque



1498PC	€ 116,00	1	014980801
--------	----------	---	-----------

## 1499

estetoscópio



1499	€ 117,00	1	014990001
------	----------	---	-----------

## 1500/...

extractores universais com duas pernas

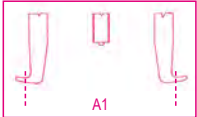
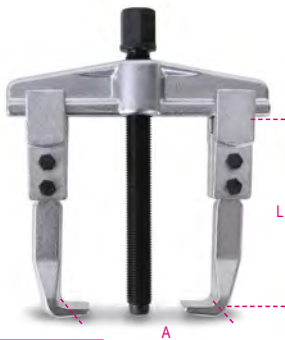

L mm	€	1	015000301
1500/1	93,00	1	015000301
1500/2	97,00	1	015000302
1500/3	161,00	1	015000303
1500/4	221,00	1	015000304
1500/5	402,00	1	015000305
1500/6	471,00	1	015000306
1500/7	705,00	1	015000307
1500/8	1.130,00	1	015000308

	A min+max mm	A1 min+max mm
1500/1	25÷80	70÷130
1500/2	25÷130	80÷180
1500/3	50÷160	105÷220
1500/4	60÷200	120÷270
1500/5	80÷250	160÷330
1500/6	80÷350	160÷420
1500/7	110÷520	195÷600
1500/8	170÷640	260÷715



1500/SP5	€ 1.040,00	1	015000325
1500/1-1500/2-1500/3			
1500/4-1500/5			
1500/SPV	90,50	1	015000001

## 1500G/...

pernas tipo normal, para artigos 1500 e 1580/81



	mm	1500	€	1	015000311
1500G/1	35	/1-2	59,50	1	015000311
1500G/3	35	/3-4	88,00	1	015000313
1500G/5	35	/5-6-7	179,00	1	015000315
1500G/8	50	/8	220,00	1	015000317
		1580/81			

## 1500N/...

extractor universal de 2 pernas

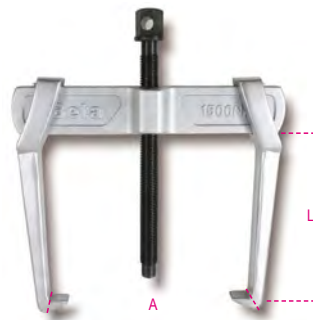

	A min+max mm	L mm	€	1	015000600
1500N0	18÷65	70	83,00	1	015000600
1500N1	23÷70	100	86,50	1	015000601
1500N2	23÷100	100	94,00	1	015000602
1500N3	35÷140	150	156,00	1	015000603
1500N4	35÷190	150	168,00	1	015000604
1500N5	43÷250	205	323,00	1	015000605
1500N6	43÷320	205	350,00	1	015000606



1500N/SP6	€ 910,00	1	015000626
1500N/0-1500N/1-1500N/2-1500N/3			
1500N/4-1500N/5			
1500N/SPV	110,00	1	015000006

## 1500N/G...

pernas para extractor 1500N



	mm	1500N	€	1	015000650
1500N/G0	10	/0	27,50	2	015000650
1500N/G1-2	12	/1-2	29,00	2	015000651
1500N/G3-4	17	/3-4	51,50	2	015000653
1500N/G5-6	23	/5-6	101,00	2	015000655

## 1501/1 - 2 - 3

extractores de pernas finas

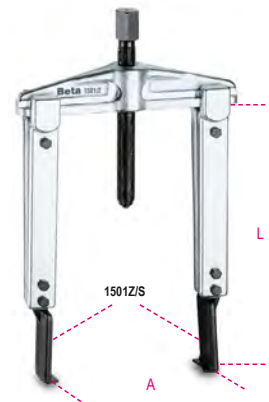

L mm	€	1	015010101
1501/1	209,00	1	015010101
1501/2	221,00	1	015010102
1501/3	233,00	1	015010103

A min+Max mm	€	1	015010101
1501/1	25÷130	1	015010101
1501/2	25÷130	1	015010102
1501/3	25÷130	1	015010103





### 1501G/1 - 2 - 3

pernas para 1501



	L mm	€		
1501G/1	100	115,00	1	015010111
1501G/2	200	134,00	1	015010112
1501G/3	250	145,00	1	015010113

### 1501Z/S - P - R

terminal para pernas 1501G



	D mm	A mm	€		
1501Z/S	2,0	27	8	41,00	2 015010211
1501Z/P	3,6	27	8	42,00	2 015010212
1501Z/R	3,6	14	8	47,00	2 015010213

### 1502/...

extrator universal de duas pernas  
com regulação e fecho rápido

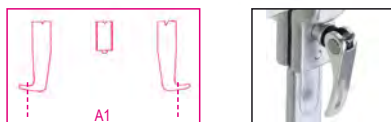
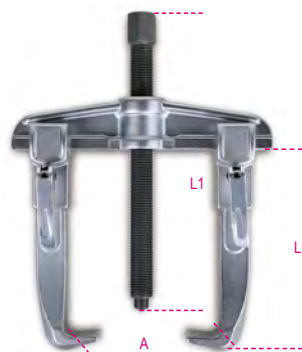

	L mm	L1 mm	€		
1502/0	100	166	138,00	1	015020000
1502/1	100	166	149,00	1	015020001
1502/2	150	247	237,00	1	015020002
1502/3	150	247	262,00	1	015020003
1502/4	200	321	449,00	1	015020004

	A min+Max mm	A1 min+Max mm
1502/0	40÷90	80÷130
1502/1	50÷130	90÷170
1502/2	65÷150	115÷210
1502/3	65÷190	125÷260
1502/4	70÷235	170÷335

### 1505V

extractor do braço limpa pára-brisas dianteiro  
e traseiro

Ponta de bronze perfurada amovível para extracção do braço,  
com jacto de água



	A Max mm	L mm	€		
1505V	43	37	51,00	1	015050001

### 1506

extractor de duas pernas  
com aperto automático

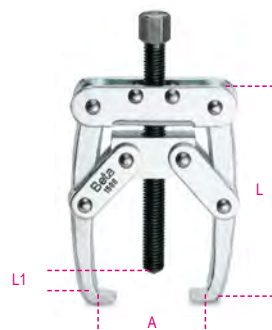

	A min+Max mm	L mm	L1 mm	€		
1506	10÷50	80	40	49,50	1	015060001

### 1508/1 - 1508/2

extractores de duas pernas,  
série ligeira

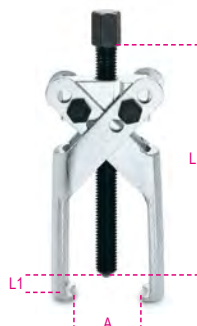

	L mm	€		
1508/1	105	166,00	1	015080001
1508/2	130	198,00	1	015080002

	A min+Max mm	L1 mm
1508/1	6÷100	85
1508/2	10÷140	120



### 1511/1 - 2 - 3

extractores exteriores  
com duas pernas reversíveis

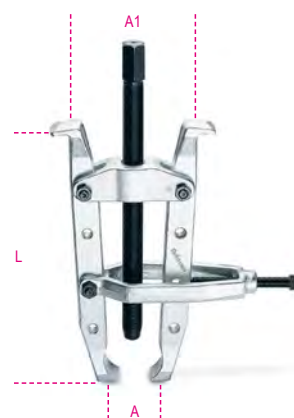

	L mm	€		
1511/1	235	282,00	1	015110001
1511/2	330	352,00	1	015110002
1511/3	405	437,00	1	015110003

	A min+Max mm	A1 min+Max mm
1511/1	20÷100	65÷95
1511/2	40÷150	103÷190
1511/3	40÷150	103÷175

### 1515/1 - 2 - 3

extractores com duas pernas  
oscilantes



	L mm	€		
1515/1	85	37,00	1	015150101
1515/2	85	39,00	1	015150102
1515/3	105	58,50	1	015150103

	A Max mm	L1 mm
1515/1	60	105
1515/2	70	105
1515/3	90	105

## 1516/1 - 2 - 3

extrator com três pernas oscilantes



	L mm	€		
1516/1	85	53,50	1	015160001
1516/2	85	57,00	1	015160002
1516/3	105	81,00	1	015160003

	A Max mm	L1 mm
1516/1	60	85
1516/2	70	85
1516/3	90	105

## 1517

extrator de 3 pernas com bloqueio automático

- Para maiores cargas de extracção.
- Efeito autoblocante

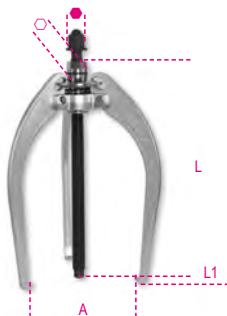

	L mm	L1 mm	Ø mm	€		
1517/90	182	60	22	289,00	1	015170000
1517/150	242	115	22	296,00	1	015170010
1517/200	307	150	22	342,00	1	015170020
1517/260	395	180	30	397,00	1	015170030

	● mm	A mm	Max kg	N
1517/90	19	18÷90	6000	59000
1517/150	19	25÷150	6000	59000
1517/200	19	40÷200	6000	59000
1517/260	27	50÷260	8000	78500



# 1517C EXTRATORES COMBINADOS DE DUAS/TRÊS PERNAS COM APERTO AUTOMÁTICO, PARA UTILIZAÇÃO EXTERNA

O extrator Beta 1517C possui um mecanismo de aperto automático das pernas acionado pela mola da cruzeta. Esta característica facilita o posicionamento e bloqueio do extrator no componente a remover. Após fixar o extrator, as pernas podem ser bloqueadas através da porca.

A cruzeta especial possui 4 apoios que permitem a utilização do extrator 1517C com 2 pernas - para trabalhos mais rápidos e fáceis - e com 3 pernas - para maior firmeza.

O pino da cabeça do parafuso quebra se o aperto máximo permitido for excedido, protegendo o extrator de sobrecargas.



## 1517C/...

extratores combinados de duas/três pernas com aperto automático

- para utilização com 2- ou 3 pernas
- aperto automático



	L mm	L1 mm	€		
1517C/0	145	250	245,00	1	015170500
1517C/1	200	300	300,00	1	015170501
1517C/2	270	300	373,00	1	015170502

	A min+max mm	● mm
1517C/0	12÷140	18
1517C/1	20÷180	18
1517C/2	30÷280	18

## 1518/...

extratores com três pernas



	L mm	€		
1518/1	105	89,50	1	015180001
1518/2	135	115,00	1	015180002
1518/3	235	203,00	1	015180003
1518/4	270	301,00	1	015180004
1518/5	270	354,00	1	015180005
1518/6	270	371,00	1	015180006

	A min+Max mm	L1 mm
1518/1	24÷100	105
1518/2	32÷160	150
1518/3	40÷220	220
1518/4	80÷250	240
1518/5	80÷300	350
1518/6	80÷350	400



## 1518U/...

extratores universais de três pernas

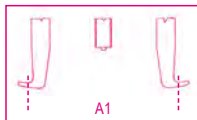
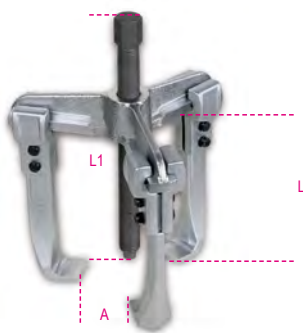

	L mm	L1 mm	€		
1518U/0	100	166	169,00	1	015180500
1518U/1	100	166	181,00	1	015180501
1518U/2	150	247	275,00	1	015180502
1518U/3	150	247	287,00	1	015180503
1518U/4	200	321	414,00	1	015180504

	A min+Max mm	A1 min+Max mm	● mm
1518U/0	40÷90	80÷130	17
1518U/1	50÷130	90÷170	17
1518U/2	65÷150	115÷210	22
1518U/3	65÷190	125÷260	22
1518U/4	70÷235	170÷335	27

## 1519/...

extratores universais de três pernas  
com regulação e aperto rápido

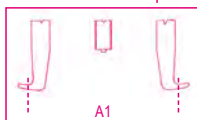
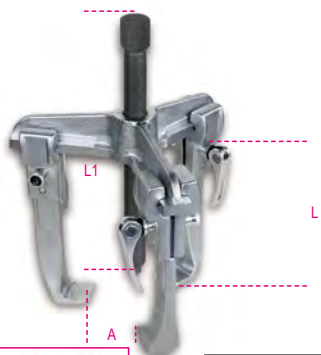

	L mm	L1 mm	€		
1519/0	100	166	195,00	1	015190000
1519/1	100	166	207,00	1	015190001
1519/2	150	247	295,00	1	015190002
1519/3	150	247	313,00	1	015190003

	A min+Max mm	A1 min+Max mm	● mm
1519/0	40÷90	80÷130	17
1519/1	50÷130	90÷170	17
1519/2	65÷150	115÷210	22
1519/3	65÷190	125÷260	22

## 1520/1 - 1520/2

extratores  
com duas pernas reversíveis



	L mm	€		
1520/1	135	85,00	1	015200101
1520/2	235	145,00	1	015200102

	A Max mm	L1 mm
1520/1	110	85
1520/2	160	140

## 1521/1 - 1521/2

extratores  
com três pernas reversíveis



	L mm	€		
1521/1	135	110,00	1	015210101
1521/2	235	193,00	1	015210102

	A Max mm	L1 mm
1521/1	110	90
1521/2	160	140

## 1528

Extrator de aperto automático para discos de  
travão



19 mm

	A min+Max mm	€		
170÷380	170÷380	207,00	1	015280000

480x240x60 mm - 4,8 kg

## 1529

extractor multi-passos para polias cónicas

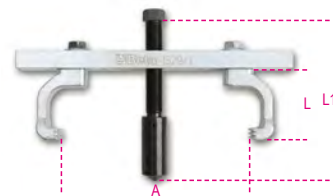

A min+Max mm	L min+Max mm	L1 min+Max mm	€		
24÷240	60÷95	90÷135	302,00	1	015290000

260x210x60 mm - 2,6 kg

## 1529PI

extractor de polia da bomba injetora

- remoção rápida e precisa da polia de injeção de combustível
  - particularmente adequado para veículos Fiat, Ford, Volkswagen, Citroën e Peugeot
- Inclui 3 parafusos para fixar o extrator na polia:  
M6 x 1.0 x 49 mm  
M7 x 1.0 x 75 mm  
M8 x 1.25 x 76 mm



	€		
1529PI	126,00	1	015290051

## 1530/C5

Kit extractores dos cubos das rodas e  
rolamentos,  
3, 4, 5 orifícios

- Contúdo:  
1 flange universal (96÷138 mm)  
1 parafuso hidráulico (12 t)  
1 batente para martelo (2.8 kg), necessário para cubos sem parafusos de fixação centrais



	€		
1530/C5	640,00	1	015300300

760x320x120 mm - 11,5 kg



## 1531/C7

kit extrator para anéis de rolamentos cubos de rodas

Inclui:

- 1 alicate Ø 40÷45 mm
- 1 alicate Ø 45÷51 mm
- 1 alicate Ø 50÷55 mm
- 1 alicate Ø 55÷61 mm



1531/C7 € 860,00 1 015310107

390x315x96 mm - 4,3 kg

## 1532

extrator de juntas



1532 € 20,00 2 015320001

## 1533/...

forças para separadores refª. 1534



	L mm	€		
1533/2	150	124,00	1	015330002
1533/3	210	235,00	1	015330003
1533/4	315	372,00	1	015330004
1533/5A	305	449,00	1	015330006

	A min+Max mm	L1 mm
1533/2	45÷140	110
1533/3	55÷205	175
1533/4	90÷260	175
1533/5A	100÷360	235

## 1533PR/1 - 2 - 3

extensões para forças refª. 1533



	€		
1533PR/1	27,00	1	015330011
1533/2			
1533PR/2	29,00	1	015330012
1533/3			
1533PR/3	30,50	1	015330013
1533/4 - 1533/5A			

## 1534/...

separadores

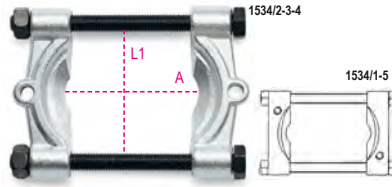

		€		
1534/1	1533/2	108,00	1	015340001
1534/2	1533/2	127,00	1	015340002
1534/3	1533/3	211,00	1	015340003
1534/4	1533/4	354,00	1	015340004
1534/5A	1533/5A	730,00	1	015340006

	A min+Max mm	L1 mm
1534/1	5÷60	63
1534/2	12÷75	75
1534/3	22÷115	118
1534/4	25÷155	154
1534/5A	30÷220	180

## 1535/C...

jogos de forças e separadores



1535/C1 € 344,00 1 015350001



260x180x40 mm - 2,5 kg

1535/C2 € 364,00 1 015350002

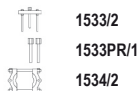

260x180x40 mm - 2,8 kg

1535/C3 € 600,00 1 015350003



380x280x55 mm - 8,0 kg

1535/C4 € 925,00 1 015350004



420x380x65 mm - 14,8 kg

1535/C5A € 1.400,00 1 015350006

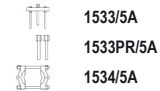

530x510x85 mm - 27,2 kg

## 1539

extrator de percussão para chapa



1539 € 198,00 1 015390001

## 1540

extrator de percussão

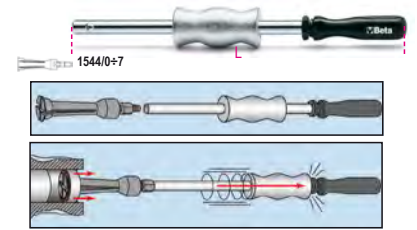

1540 € 105,00 1 015400001

## 1542/1 - 1542/2

extractores de duas pernas para expansores



	A min+Max mm	1544 0÷7	€		
1542/1	35÷75	0÷7	90,50	1	015420001
1542/2	60÷130	9C-10C	137,00	1	015420002

	L mm	L1 mm
1542/1	140	140
1542/2	175	160



## 1544/...

piças de expansão para interiores

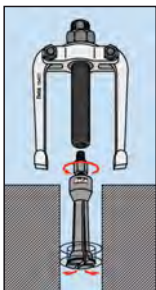

	C mm	Ø	€	📦	📄
1544/0	0,25	M10	80,00	1	015440100
A= 5÷7					
1544/A	0,80	M10	83,00	1	015440105
A= 7÷9					
1544/1	0,80	M10	85,00	1	015440110
A= 9÷12					
1544/2	1,15	M10	87,00	1	015440120
A= 13÷17					
1544/2B	1,00	M10	89,00	1	015440121
A= 14÷19					
1544/3	1,70	M10	92,00	1	015440130
A= 16÷21					
1544/4	1,65	M10	102,00	1	015440140
A= 20÷25					
1544/5	2,00	M10	109,00	1	015440150
A= 25÷30					
1544/6	3,00	M10	137,00	1	015440160
A= 30÷37					
1544/7	3,80	M10	155,00	1	015440170
A= 38÷45					
1544/9C	2,60	G 3/8"	224,00	1	015440189
A= 40÷75					
1544/10C	7,30	G 3/8"	309,00	1	015440199
A= 70÷115					

## 1545/C5M

extractor refª. 1542/1  
com 5 expansores da refª. 1544



1545/C5M	€	📦	📄
	610,00	1	015450011

1542/1	● 24 mm
1544/1	9÷12 mm
1544/2	13÷17 mm
1544/3	16÷21 mm
1544/4	20÷25 mm
1544/5	25÷30 mm
📦 265x180x45 mm - 📄 2,4 kg	

## 1547/C6

extractor de rolamentos de esferas



1547/C6	€	📦	📄
	312,00	1	015470006
📦 420x185x60 mm - 📄 3 kg			

## 1547KP

jogo de 3 pares de terminais redondos falsos



	Ø mm	€	📦	📄
1547KP/1	9-11-12,5	49,00	1	015470106
1547KP/2	5-6-8	34,00	1	015470206

## 1547P

extensões hexagonais



	L mm	€	📦	📄
1547P/1	205 1547/1	10,70	1	015470101
1547P/2	102 1547/2	6,80	1	015470201

## 1547PC/2

extensões redondas, série curta

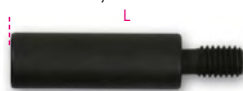

	L mm	€	📦	📄
1547PC/2	42 1547/2	5,50	1	015470202

## 1547PL/2

extensões redondas, série longa



	L mm	€	📦	📄
1547PL/2	106 1547/2	6,20	1	015470203

## 1550U

prensa pneumática para molas de amortecedores de automóveis, carrinhas e veículos comerciais

CE

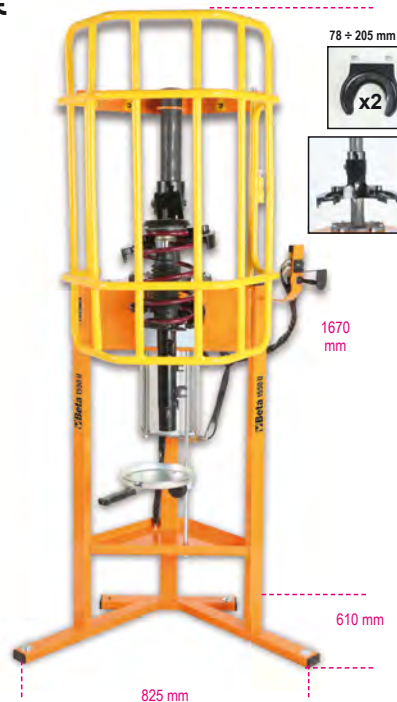

**MAIOR POTÊNCIA:** pressão máxima 2 toneladas (10 bars)  
**SISTEMA DE FIXAÇÃO SUPERIOR UNIVERSAL:** permite a compressão de todos os diâmetros de mola esq./dir. com um prato superior adaptável  
**SISTEMA DE SEGURANÇA ATIVO NA MOLLA:** gancho de segurança e 3 válvulas de bloqueio permitem o posicionamento correto da mola, mantendo a posição durante a compressão. Se a mola não estiver na posição correta, o sistema imobiliza a máquina  
**GRELHA DE PROTEÇÃO:** máxima segurança e cobertura da área de trabalho  
**ALAVANCA DE COMANDO:** maior precisão e sensibilidade durante a compressão  
**POSIÇÃO DE TRABALHO:** altura de trabalho no garfo posterior elevado até 875 mm

Fornecido com 2 garfos inferiores para diâm. 78-205 mm

**CARACTERÍSTICAS TÉCNICAS**

Pressão máxima:  
 2 toneladas (10 bars) - 1.6 toneladas (8 bars) - 1.2 toneladas (6 bars)  
 Curso compressão da mola: 335 mm

1550U	€	📦	📄
	3.450,00	1	015500010

## 1550U/CGS-R

Garfos superiores rebaixados, para item 1550U



1550U/CGS-R € 665,00 1 015500035

## 1550U/MRC-ABE

garfos especiais para artigo 1550U, especialmente concebidos para veículos Mercedes classe A-B-E



1550U/MRC-ABE € 685,00 1 015500031

## 1550U/MRC-C

garfos especiais para artigo 1550U, especialmente concebidos para veículos Mercedes classe C



1550U/MRC-C € 605,00 1 015500032

## 1550U/S...

forquilha para artigo 1550U



	∅ mm	€		
1550U/S 130	78÷130 mm	435,00	1	015500014
1550U/S 182	105÷182 mm	435,00	1	015500015
1550U/S 205	125÷205 mm	435,00	1	015500016

## 1550U/SS187

garfo esquerdo para item 1550U

Particularmente adequado para molas esquerdas, por ex. em: Nissan Qashqai e Renault Koleos



1550U/SS 187 € 435,00 1 015500018

## 1550U/M

torno para ferramenta remoção de amortecedores 1550U

Permite bloquear a haste do amortecedor



1550U/M € 414,00 1 015500021

## 1551/C20

Kit de ferramentas para extração das cabeças dos amortecedores

Inclui:

- 7 chaves de caixa sextavadas: 16 - 17 - 18 - 19 - 21 - 22 - 24
- 1 extensão para chave de caixa 120 mm
- 3 bits fêmea de fenda: 8x5 - 8x6 - 11x8
- 1 bit fêmea sextavada 10 mm
- 1 bit macho XZN(R) M10
- 1 bit macho Torx(R) T50
- 4 bits machos sextavadas: 5- 6 - 7 - 8
- 1 extensão para porta-bits 95 mm
- 1 extensão para porta-bits 190 mm



∅ 8 - 21 mm

1551/C20 € 183,00 1 015510020

320x245x71 mm - 2,6 kg

## 1552/C9

Kit de desmontagem dos amortecedores e dos braços de suspensão e direção

possível utilizar em versão simples ou dupla para desmontagem dos braços de suspensão e direção duplos de veículos do grupo VAG



∅ 13 mm

1552/C9 € 145,00 1 015520020

195x140x40 mm - 1,0 kg



## 1555/Q

compressor para molas de amortecedores MacPherson e equivalentes  
Impulso máx.: 1500 kg

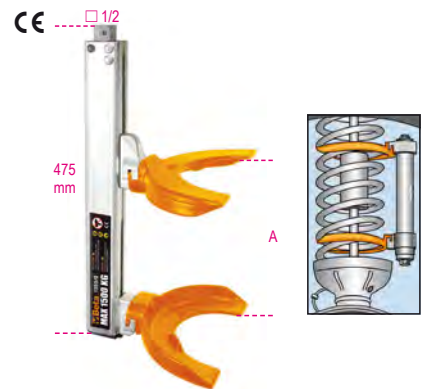

A min+Max mm	∅ min+Max mm	€		
65÷354	80÷195	945,00	1	015550006

## 1555/QS

compressor para molas de amortecedores tipo MacPherson e equivalente



A min+Max mm	∅ min+Max mm	€		
70÷300	80÷200	1.160,00	1	015550005

## 1555S/BMW-RNT

forquilha para BMW E39, amortecedores E46 e Renault Mégane II, para artigos 1555DS e 1555/QS



1555S/BMW-RNT € 365,00 1 015550303



## 1556/1A

compressores de molas de amortecedores

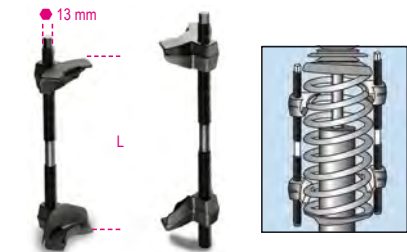

min L Max  
mm mm € 1 015560101  
65÷320 272,00

## 1556/2A

compressores de molas de amortecedores



min L Max  
mm mm € 1 015560102  
65÷200 269,00

## 1557/S3

jogo de 3 chaves para casquilhos de amortecedores

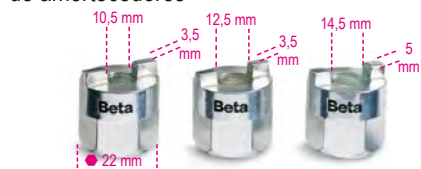

1557/S3 € 78,50 1 015570010

## 1558/C4

ferramenta para anel retentor interno e externo, operada por parafuso

Encabadouro quadrado permite a aplicação de uma força elevada em ambas as condições de operação  
Pontas fornecidas:  
Ø 2,5-3-3,5 mm



1558/C4 € 195,00 1 015580100  
330x220x50 mm - 900 g

## 1558P

Par de pontas para anéis de retenção para artigo 1558



Ø mm	€	1	015580125
2,5	9,90	1	015580125
3,0	9,90	1	015580130
3,5	9,90	1	015580135

## 1558/C13

Ferramenta para anel retentor interno e externo, operada por parafuso

Encabadouro quadrado permite a aplicação de uma força elevada em ambas as condições de operação

Pontas fornecidas:  
• direita: Ø 2,5 - 3 - 3,5 - 3,8 mm  
• 45°: Ø 2,5 - 3 - 3,5 - 3,8 mm  
• 90°: Ø 2,5 - 3 - 3,5 - 3,8 mm



1558/C13	Ø mm	Ø mm	€	1	015580200
	5,5÷77	5,5÷77	260,00	1	015580200

330x220x45 mm - 1,6 kg

## 1559

extractor se rótulas tipo ligeiro



	A Max mm	Ø mm	€	1	015590001
1559/22	50	18÷22	101,00	1	015590001
1559/36	90	36	462,00	1	015590036
1559/45	115	45	695,00	1	015590045

## 1559V/8T

parafuso hidráulico para extractores de rótulas 1559/36 e 1559/45



Nm	t	€	1	015590145
80000	8	349,00	1	015590145

## 1560/2

extractor de rótulas modelo profissional



1560/2	A min+Max mm	Ø mm	€	1	015600002
	60÷85	20	215,00	1	015600002

## 1560A

extractor de rótulas



1560A	€	1	015600601
	288,00	1	015600601

## 1561/...

extractor de rótulas



	L mm	A mm	D mm	€	1	015610001
1561/1	39	36,6	18	78,00	1	015610001
1561/2	47	45,7	25	102,00	1	015610002
1561/3	63	62	30	149,00	1	015610003
1561/4	75	63	40	189,00	1	015610004

## 1562D

extractor de rótulas

Fornecido com 2 parafusos para extracção de rótulas da suspensão e da direcção



A max mm	Ø mm	L mm	€	1	015620239
50	39	26	392,00	1	015620239

## 1565/1 - 2 - 3

extractor de rótulas por percussão



	D mm	L1 mm	€		
1565/1	18	65	89,00	1	015650001
1565/2	23	65	101,00	1	015650002
1565/3	30	88	105,00	1	015650003

## 1566N

ferramenta para remoção/instalação de braços de direcção



Ø x L mm	Ø mm	€		
28÷35 x 400	27	142,00	1	015660005
35÷45 x 400	27	160,00	1	015660010

## 1566R

ferramenta ajustável para remoção/instalação de braços de direcção



Ø mm	€		
27÷43	27,00	1	015660015

## 1566/G01

extractor de rótulas homocinético

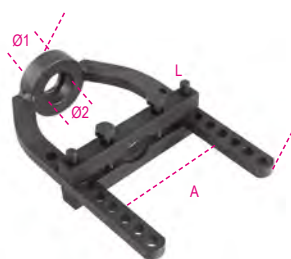

L mm	A mm	Ø1 mm	Ø2 mm	€		
250	115	29	36	169,00	1	015660052

## 1566/VAG

jogo de chaves de impacto com perfil XZN® para parafusos do eixo de veículos do Grupo VAG

Tamanhos incluídos no jogo:

- chave de impacto macho XZN® M12 L 77 mm
- chave de impacto macho XZN® M12 L 120 mm



Ø	L1	L2	€		
M12	77	120	48,00	1	015660060

## 1567

alavanca para extracção do terminal do braço oscilante da suspensão e dos amortecedores

Utilização apenas por um operador



A mm	B min=Max mm	€		
1060	100÷300	389,00	1	015670001

## 1568

pinça pneumática para foles

8 braços extensores  
extensão máxima do braço: 145 mm



L mm	L1 mm	€		
420	195	277,00	1	015680001

## 1569/F

jogo ferramentas para remoção e inserção de sinoblocos em Fiat Panda, Fiat 500 e Ford Ka



1569/F	€		
	515,00	1	015690021

## 1569/SB

jogo de ferramentas para extração e colocação de sino-blocos no eixo traseiro, vedantes de óleo do eixo de direcção e rolamentos das rodas

- possibilidade de utilização dos casquilhos no veículo ou na prensa hidráulica



1569/SB	€		
	287,00	1	015690016

≡ 425x365x100 mm - 13 kg

## 1569/CP

chave de pancada para instalação de rolamentos cônicos e vedantes

Ajuste rápido



	Ø mm	L mm	€		
1569CP/50	9,5+50	130	152,00	1	015690750
1569CP/90	18+90	145	189,00	1	015690790

## 1570/3

pressas hidráulicas para extractores



t	L mm	L1 mm	mm	€		
30	243	36	19	265,00	1	015700003

## 1580/8I

extractor hidráulico universal com duas pernas

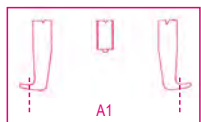
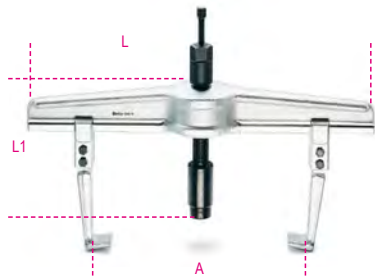

1580/8I	€		
	1.700,00	1	015800008

1580/8I	A min=Max mm	L mm	L1 mm	A1 min=Max mm	N Max
	170÷640	715	280	260÷715	180000

## 1580GL

pernas soltas, série longa, para extractores 1580/8I



1580GL/8A	L mm	€		
	300	192,00	1	015800227
1580GL/8B	400	214,00	1	015800228
1580GL/8C	500	273,00	1	015800229



## 1585/5I - 6I - 7I

extractores hidráulicos de três pernas

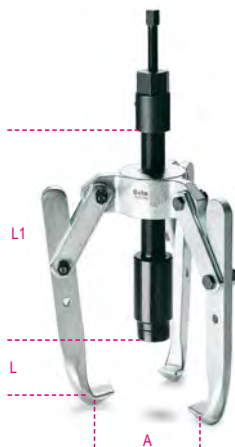

	€		
1585/5I	1.180,00	1	015850005
1585/6I	1.250,00	1	015850006
1585/7I	1.280,00	1	015850007

	A min=Max mm	L1 mm	L mm	N Max
1585/5I	50÷350	135	280	150000
1585/6I	50÷350	235	280	150000
1585/7I	50÷350	335	280	150000

## 1585GI/5 - 6 - 7

pernas para extractor hidráulico ref. 1585/I-1585/6I-1585/7I

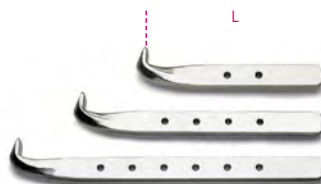

	L mm	€		
1585GI/5	135	108,00	1	015850205
1585GI/6	235	127,00	1	015850206
1585GI/7	335	154,00	1	015850207

## 1589VI

fuso hidráulico para extractores 1580/8I e 1585/5I-1585/6I-1585/7I



1589VI	€		
	700,00	1	015890001

## 1589PI/50 - 100 - 150

extensão para fuso hidráulico



	L mm	L1 mm	€		
1589PI/50	50	70	63,50	1	015890005
1589PI/100	100	120	69,50	1	015890010
1589PI/150	150	170	76,00	1	015890015

## 1590

extensão para fuso hidráulico



A max mm	L1 mm	€		
60	55	30,50	2	015900305
100	65	49,00	2	015900310
150	95	81,50	2	015900315

## 1591

grampos de carpinteiro

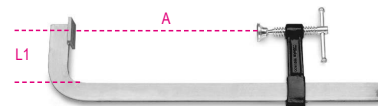

A ~	A max mm	L1 mm	€		
200	200	80	32,00	2	015910020
300	310	85	39,50	2	015910030
400	410	85	42,50	2	015910040
500	500	95	57,50	2	015910050
600	600	95	58,50	2	015910060
800	800	95	71,00	2	015910080
1000	1000	110	89,00	2	015910100

## 1593

grampos com fuso

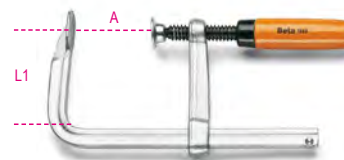

A ~	A max mm	L1 mm	€		
160	170	80	38,00	2	015930016
200	240	100	58,50	2	015930020
300	320	145	82,00	2	015930030

## 1594

grampos com alavanca

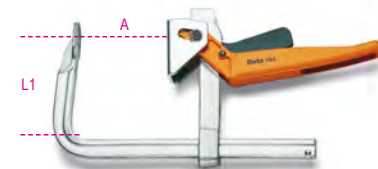

A ~	A max mm	L1 mm	€		
200	240	145	127,00	1	015940020
250	290	145	132,00	1	015940025
300	340	145	142,00	1	015940030
400	430	150	148,00	1	015940040
500	530	150	156,00	1	015940050
600	630	150	163,00	1	015940060



## 1595

grampos com fuso

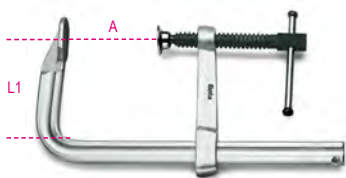

A	A max	L	€		
mm	mm	mm			
200	230	100	60,50	2	015950020
250	270	120	66,00	2	015950025
300	330	120	84,00	2	015950030
400	420	120	94,50	2	015950040
500	520	125	103,00	2	015950050
600	620	125	109,00	2	015950060
800	820	125	129,00	1	015950080
1000	1030	125	143,00	1	015950100

## 1599F

tornos paralelos de bancada, forjados

Totalmente fundido em aço. Superfície do mordente fresada e endurecida. Abertura frontal. Profundidade de aperto elevada.



L1	BxH	Ø	A MAX	€		
mm	mm	mm	mm			
100	92x46	11	125	377,00	1	015990100
125	108x54	13	150	481,00	1	015990125
150	125x62	13	200	675,00	1	015990150
175	140x70	15	220	925,00	1	015990175

## 1599GI

torno de bancada com mordentes intercambiáveis

- com guia quadrada para trabalhos pesados
- mordentes intercambiáveis com superfície reforçada

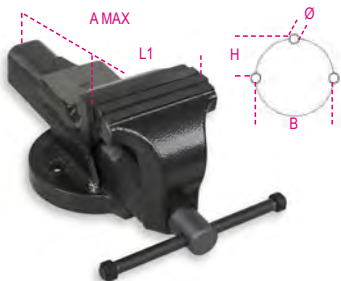

L1	BxH	Ø	A MAX	€		
mm	mm	mm	mm			
100	92x46	11	125	290,00	1	015990200
125	108x54	13	150	399,00	1	015990225
150	125x62	13	200	545,00	1	015990250
175	140x70	15	220	730,00	1	015990275

## 1599GR

pares de mordentes e parafusos sobresselentes para torno 1599GI



	A	€		
	mm			
1599GR 100	100	28,00	1	015990920
1599GR 125	125	35,00	1	015990925
1599GR 150	150	42,50	1	015990950
1599GR 175	175	49,50	1	015990975

## 1599P

tornos de bancada paralelos

Mordentes endurecidos. Bigorna com grande superfície lacada. Base quadrada em aço.

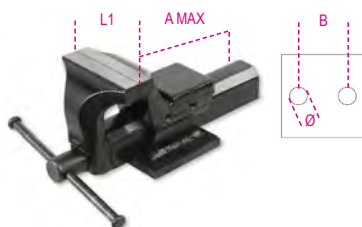

L1	B	Ø	A MAX	€		
mm	mm	mm	mm			
100	92	11	111	331,00	1	015990000
125	108	13	130	397,00	1	015990025
150	130	15	170	555,00	1	015990050

## 1599B

bases rotativas para artigo 1599P



	1599P	€		
1599B 100	100	138,00	1	015990810
1599B 125	125	157,00	1	015990812
1599B 150	150	195,00	1	015990815

## 1599T

tornos para engenhos de furar de coluna

Tornos especiais em ferro fundido, com mordentes temperados e retificados. Para engenhos de furar de coluna de pequenas e médias dimensões

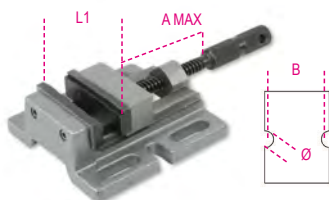

L1	B	Ø	A MAX	€		
mm	mm	mm	mm			
80	111	11	65	187,00	1	015990480
100	120	13	87	232,00	1	015990500

## 1599G

par de coberturas para mordentes em alumínio

- magnéticas em todo o seu comprimento
- interior estriado para fixação de peças roscadas

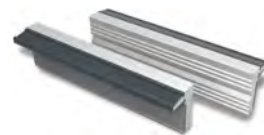

A	€		
mm			
100	60,50	1	015990910
125	63,00	1	015990912
150	69,00	1	015990915
180	76,50	1	015990917

## 1600Q 8

chave de 4 bocas para operadores de painéis de controlo.

quadrada / 6 / 7-8 mm  
triangular 7 / 9 mm  
ponta dupla 3-5 mm  
sextavada 1/4"  
fenda 1.0x7 mm + cruz PH2

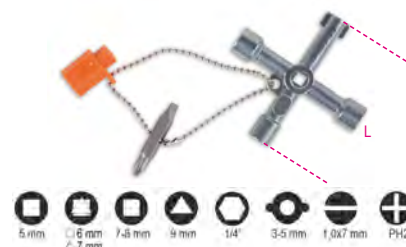

L	€		
mm			
76	34,00	1	016000008

## 1600Q 10

Chave de 8 bocas, com junta articulada, para operadores de painéis de controlo.

quadrada 5 / 6-7 / 8-9 mm  
triangular 5-6-7 / 8-9 / 10 mm  
ponta dupla 3-5 mm  
hexagonal 1/4"  
quadra macho 1/4"



L	€		
mm			
125	43,00	1	016000010



# SERVIÇO DE CERTIFICAÇÃO PARA INSTRUMENTOS DE MEDIÇÃO

A certificação de instrumentos de medição é essencial nos setores ou campos de aplicação em que são essenciais medições precisas, inequívocas e perceptíveis.

A certificação envolve a emissão de um certificado Accredia:

**A Beta Utensili S.p.A. fornece o serviço de certificação, a pedido, para Paquímetros, Paquímetros Digitais, Medidores, Micrómetros e Apalpa Folgas. Para requerer este serviço, contacte o seu revendedor.**



## 1650

paquímetro leitura vigesimal

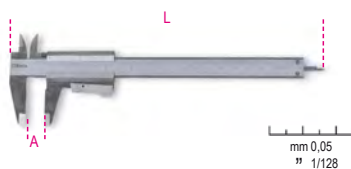

UNI EN ISO 13385-1DIN 862

A max mm	L mm	€		
150	235	67,00	1	016500001
200	290	88,00	1	016500002

## 1650FD

paquímetro para discos de travões, leitura decimal

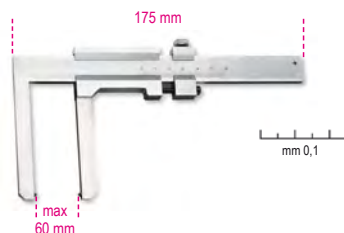

1650FD	€		
	250,00	1	016500050

## 1651DGTB

vernier digital, leitura até 0.01 mm

Características:

- leitura até 0.01 mm
- bloqueio parafuso deslizante
- conversão mm/polegadas
- regulação a zero em qualquer posição
- haste de profundidade quadrada até 300 mm
- em estojo de plástico rígido

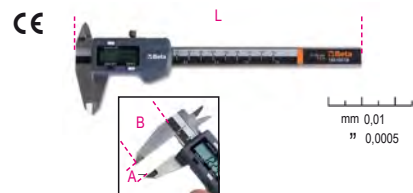

UNI EN ISO 13385-1DIN 862CE

A Max mm	L mm	B mm	€		
150	235	40	113,00	1	016510211
200	285	50	147,00	1	016510212
300	400	60	192,00	1	016510213



## 1651DGTB/IP

vernier digital, leitura até 0.01 mm, grau de proteção IP67

- leitura até 0.01 mm
- bloqueio parafuso deslizante
- conversão mm/polegadas
- acionamento automático movimentando o vernier ao longo da escala
- regulação a zero em qualquer posição
- função FIXAR
- medição em modo absoluto e gradual

Grau IP67 proporciona total proteção contra poeiras e líquidos, mantendo as características funcionais do vernier, por ex., quando se encontra totalmente submerso.

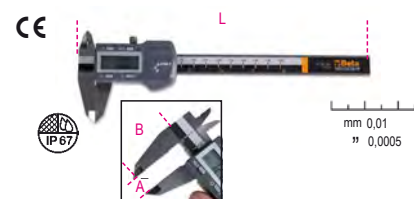

UNI EN ISO 13385-1 DIN 862CE

A Max mm	L mm	B mm	€		
150	235	40	185,00	1	016510711

270x115x35 mm - 450 g

## 1652

paquímetro analógico, leitura analógica quinquagesimal



UNI EN ISO 13385-1DIN 862

1652	€		
	142,00	1	016520016

## 1654

paquímetro leitura quinquagesimal



UNI EN ISO 13385-1DIN 862

A max mm	L mm	€		
200	330	310,00	1	016540020
300	410	420,00	1	016540030



## 1654DGT

paquímetro digital,  
leitura até 0.01 mm  
leitura até 0.0005"

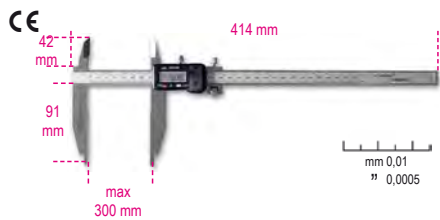

UNI EN ISO 13385-1DIN 862CE

1654DGT € 710,00 1 016540111

## 1656

paquímetro de profundidade  
com ponta leitura vigesimal

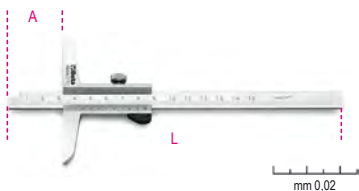

UNI EN ISO 13385-2DIN 862

A max mm	L mm	€	1	016560020
200	260	147,00	1	016560020
300	360	216,00	1	016560030

## 1657DGT/2

paquímetro digital de profundidade  
leitura centesimal

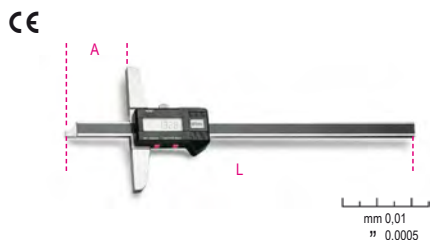

UNI EN ISO 13385-2DIN 862CE

A max mm	L mm	€	1	016570002
200	270	274,00	1	016570002

## 1658/...

micrômetros para exteriores  
leitura centesimal



DIN 863/II

A mm	€	1	016580025
1658/25 0÷25	84,50	1	016580025
1658/50 25÷50	92,00	1	016580050
1658/75 50÷75	104,00	1	016580075
1658/100 75÷100	114,00	1	016580100

## 1658/C4

jogo de 4 micrômetros modelo 1658



DIN 863

1658/C4 € 340,00 1 016580001

1658/25	0÷25 mm
1658/50	25÷50 mm
1658/75	50÷75 mm
1658/100	75÷100 mm
365x245x35 mm - 2,5 kg	

## 1658DGTB

micrômetro digital exterior IP65, leitura até 0.001 mm

- leitura até 0.001 mm
- calibres em aço reforçado
- bloqueio da alavanca deslizante
- conversão mm/polegadas
- regulação a zero em qualquer posição
- medição em modo absoluto e gradual
- fornecido com chave de calibragem



DIN 863CE

1658DGTB 25	231,00	1	016580525
1658DGTB 50	287,00	1	016580550

## 1658SP/1

suporte para micrômetro



1658SP/1 € 58,50 1 016580910

## 1659

medidor de espessura  
com comparador leitura centesimal

C = campo de comparação



1659 C mm 0÷10 € 217,00 1 016590001

## 1662/1 - 1662/2

comparador leitura centesimal

C = campo de comparação



DIN 878

1662/1	C mm 0÷5	€ 99,50	1	016620001
1662/2	C mm 0÷10	€ 122,00	1	016620010

## 1662DGT/A

comparador digital,  
leitor para 0.01 mm  
C = Campo de leitura



1662DGT/A C mm 0-12,5 € 301,00 1 016620311





## 1662AN

comparador analógico,  
com ponteira orientável,  
leitura até 0.01 mm  
Campo de leitura



DIN 2270

	C mm	€		
1662AN	0÷0,8	235,00	1	016620200

## 1662SPO

base magnética



1662SPO	84,00	1	016620800
---------	-------	---	-----------

## 1662SP2

suporte com base magnética  
articulado



1662SP2	152,00	1	016620910
---------	--------	---	-----------

## 1666

esquadro simples em aço inoxidável  
rectificado e polido



DIN 875/0

L mm	L1 mm	€		
100	70	69,00	1	016660210
150	100	100,00	1	016660215
200	130	120,00	1	016660220
250	165	155,00	1	016660225
300	200	195,00	1	016660230

## 1666A

esquadro de cepo em aço inoxidável  
rectificado e polido



DIN 875/0

L mm	L1 mm	€		
100	70	101,00	1	016660110
150	100	137,00	1	016660115
200	130	193,00	1	016660120
250	170	239,00	1	016660125
300	200	303,00	1	016660130

## 1668

esquadro de cepo  
em aço normalizado  
retificado



DIN 875/2

L mm	L1 mm	€		
100	70	30,50	2	016680210
150	100	40,50	2	016680215
200	130	53,00	2	016680220
250	165	77,00	1	016680225
300	174	94,50	1	016680230

## 1668A

esquadro de cepo  
em aço normalizado rectificado



DIN 875/2

L mm	L1 mm	€		
100	70	36,00	2	016680110
150	100	56,00	2	016680115
200	130	71,00	2	016680120
250	165	102,00	1	016680125
300	176	122,00	1	016680130

## 1670

esquadros de precisão  
em aço rectificado



L mm	L1 mm	€		
100	70	19,00	3	016700010
150	100	19,80	3	016700015
200	130	22,30	3	016700020
250	160	24,40	3	016700025
300	175	27,00	3	016700030
400	230	40,00	2	016700040
500	280	44,50	2	016700050
600	330	47,00	2	016700060
800	395	64,50	1	016700080
1000	500	77,00	1	016700099

## 1670A

esquadros de cepo  
em aço rectificado



L mm	L1 mm	€		
100	70	24,90	3	016700110
150	100	27,00	3	016700115
200	130	29,00	3	016700120
250	165	35,00	3	016700125
300	175	41,50	3	016700130
400	230	54,50	2	016700140
500	280	72,50	2	016700150
600	330	81,50	2	016700160
800	420	96,50	1	016700180
1000	500	120,00	1	016700199

## 1672

suta corrediça lâmina e base em aço

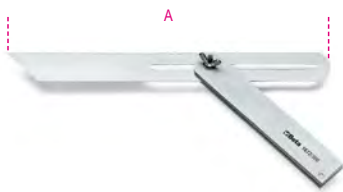

A mm	€	Unidade	Artigo
300	58,00	2	016720030

## 1672A

suta corrediça com lâmina em aço cromado e base em alumínio

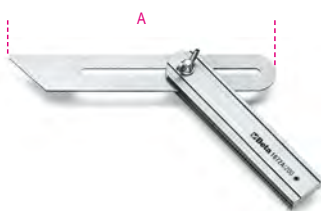

A mm	€	Unidade	Artigo
200	30,00	3	016720120
300	33,00	3	016720130

## 1674A

esquadros para marceneiro lâmina em aço base em alumínio, dupla escala milimétrica



L mm	L1 mm	€	Unidade	Artigo
300	169	28,50	2	016740130
400	214	35,50	2	016740140

## 1674C

esquadro para marceneiro com lâmina em aço e nível de superfície

- Escala dupla mm
- Nível de superfície

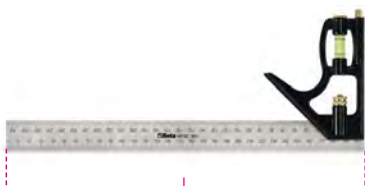

L mm	€	Unidade	Artigo
300	20,80	2	016740230

## 1676

goniômetro simples em aço inoxidável

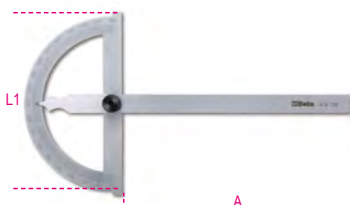

A mm	A mm	L1 mm	G mm	€	Unidade	Artigo
120	120	80	1°	45,00	2	016760012
150	165	120	1°	52,00	2	016760015
200	210	150	1°	63,00	2	016760020
300	310	200	1°	84,50	1	016760030

## 1678/C3

transferidor de ângulos em aço inoxidável



1678/C3	L Max mm	D mm	€	Unidade	Artigo
	300	70	321,00	1	016780030

## 1679

paquímetro de traçagem com rolete em aço inoxidável, leitura decimal

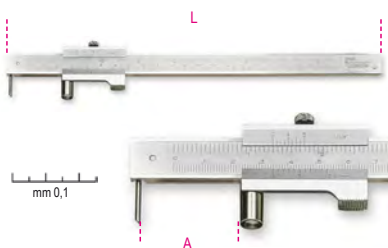

L mm	A Max mm	€	Unidade	Artigo
235	200	97,00	1	016790020

## 1679/PR

ponta sobresselente para manômetro universal 1679



1679/PR	€	Unidade	Artigo
	15,70	1	016790021

## 1680

compassos de vara corpo e pontas de traçagem em aço temperado

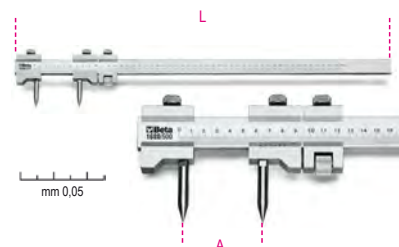

L mm	A Max mm	€	Unidade	Artigo
660	500	321,00	1	016800050

## 1680A

compassos de precisão para interiores



L mm	A Max mm	€	Unidade	Artigo
150	144	20,90	2	016800115
200	200	25,50	2	016800120
250	245	31,50	1	016800125
300	300	36,00	1	016800130

## 1680B

compassos de precisão para exteriores



L mm	A Max mm	€	Unidade	Artigo
150	155	20,90	2	016800215
200	190	25,50	2	016800220
250	235	31,50	1	016800225
300	280	36,00	1	016800230

## 1680C

compassos de precisão para traçagem pontas direitas em aço temperado



L mm	A Max mm	€	Unidade	Artigo
150	138	20,90	2	016800315
200	190	25,50	2	016800320
250	235	31,50	1	016800325
300	280	36,00	1	016800330

## 1682

régua graduada flexíveis em aço inoxidável

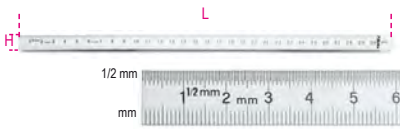

L mm	H mm	± mm	€	5	1
150	13	0,5	3,40	5	016820015
200	13	0,5	3,65	5	016820020
250	13	0,5	4,60	5	016820025
300	13	0,5	5,70	5	016820030
500	13	0,5	12,90	2	016820050
1000	13	0,5	33,50	2	016820100

## 1683

régua graduada semi-rígidas em aço inoxidável

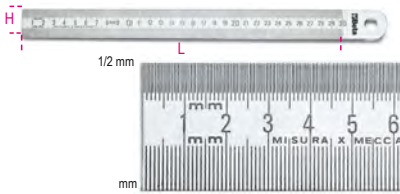

L mm	H mm	± mm	€	5	1
300	30	1	10,10	5	016830030
500	30	1	16,90	2	016830050
1000	30	1	42,50	2	016830100
1500	30	1	95,00	1	016830150

## 1685/C7

jogo de 7 ferramentas para medir e traçar



1685/C7	€	5	1
	326,00		016850110

	1650	160 mm
	1658/25	0÷25 mm
	1670	100 mm
	1680C	150 mm
	1682	150 mm
	1688BC	165 mm
	1688BC/R	

320x210x37 mm - 1,2 kg

## 1687A

riscador com punho para mecânico, tipo curvo a 90°



1687A	L mm	L1 mm	€	5	1
	153	80	7,10		016870120

## 1687AC

riscador com punho para mecânico, tipo curva curta a 90°

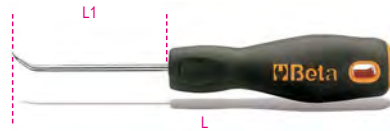

1687AC	L mm	L1 mm	€	5	1
	153	80	7,10		016870125

## 1687D

riscador com punho para mecânico, tipo direito

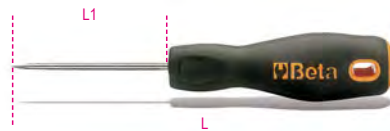

1687D	L mm	L1 mm	€	5	1
	153	80	7,10		016870110

## 1687U

riscador com punho para mecânico, tipo gancho



1687U	L mm	L1 mm	€	5	1
	153	80	7,10		016870115

## 1687/S4

jogo de 4 riscadores com punho para mecânico



1687/S4	€	5	1
1687A-1687AC 1687D-1687U	28,50		016870150

## 1688

riscador em aço temperado



1688	L mm	Ø mm	€	5	1
	250	2	9,40		016880020

## 1688A

riscador em aço temperado, extremidade em carbonato de tungstênio



1688A	L mm	Ø mm	€	5	1
	200	4	16,90		016880120

## 1688PC

riscador em aço temperado, com acabamento cromado



1688PC	L mm	Ø mm	€	5	1
	150	1	40,00		016880300

## 1688PC/R

ponta de substituição para artigo 1688PC



1688PC/R	€	5	1
	11,70		016880310

## 1688M

lápiz



1688M	L mm	€	50	1
	180	1,29		016880880

## 1690F

fita métrica feita de fibra de vidro, classe III



1690F/2	L m	S mm	€	5	1
	2	17	13,50		016900220

## 1690L

fita métrica feita de vidro flexível, classe III



1690L/2	L m	S mm	€	5	1
	2	17	14,70		016900200



## 1691BM

fitas métricas revestimento ABS de dois componentes resistentes ao choque, fita em aço, precisão classe II

CE



	L m	S mm	€		
1691BM/5	5	25	17,60	1	016910205
1691BM/8	8	32	26,50	1	016910208
1691BM/10	10	32	32,00	1	016910210

## 1691MG

fitas métricas com ímãs fixos, caixas ABS anti-impacto, fitas em aço, classe de precisão: II

CE



	L m	S mm	€		
1691MG/5	5	25	15,90	1	016910405
1691MG/8	8	25	22,20	1	016910408
1691MG/10	10	25	23,40	1	016910410

## 1692

fitas métricas, caixa em ABS anti-choque, fitas em aço, classe de precisão II

CE



	L m	S mm	€		
1692/2	2	16	8,60	5	016920052
1692/3	3	16	10,70	5	016920053
1692/5	5	19	15,30	5	016920055
1692/8	8	25	22,00	5	016920058

## 1693

Medidor de distância laser, 20 metros

### MEDIÇÕES:

- medição de distância única
- medição contínua ou medição mínima

Função desligar (off) automática  
Autonomia: até 4,000 medições

CE  
IP54

### DADOS TÉCNICOS:

Amplitude de medição: 0.05 + 20 m (0.2ft + 66ft)  
Unidades de medida: m, in, ft  
Precisão de medição: ±1.5 mm (± 0.06 in)  
Classe de laser: 2  
Pilhas: AAA 2 x 1.5V

	H mm	L mm	S mm	€		
1693 20	100	36	23	135,00	1	016930020

## 1693L

medidor de distâncias a laser, multifunções, 40 m, com níveis de posicionamento

### MEDIÇÕES:

- medição de distância simples
  - medição contínua ou medição mínima
- ### FUNÇÕES:
- adição/subtração
  - medição de área
  - medição de volume
  - medição indireta de variável (medição de Pitágoras)
  - medição de inclinação

acionamento automático desligado  
duração da bateria: até 5.000 medições  
estojo em tecido suave (incluído)

CE  
IP54

### Características técnicas:

- Intervalo de medição: 0.05 + 40 m (0.2in + 131ft)
- Seleção da escala: m, in, ft
- Precisão de medição: ±1.5 mm (± 0.06 in)
- Classe de laser: 2
- Armaz. máx.: 99 unidades
- Pilhas: AAA 2 x 1.5V

	H mm	L mm	S mm	€		
1693L 40	115	50	25	164,00	1	016930040

## 1693M

Medidor de distância laser, multiusos, 80 m

### MEDIÇÕES:

- medição de distância
- medição contínua ou medição mínima

### FUNÇÕES:

- adição/subtração
- medição de área
- medição de volume
- medição indireta (função Pitágoras)
- medição de inclinação

Função desligar (off) automática

Bolsa de pano (incluída)  
Autonomia: até 4,000 medições

CE  
IP54

### DADOS TÉCNICOS:

Amplitude de medição: 0.05 + 80 m (0.2 ft + 229ft)  
Unidades de medida: m, in, ft  
Precisão de medição: ±1.5 mm (± 0.06 in)  
Classe de laser: 2  
Memória: 99 unidades  
Pilhas: AAA 2 x 1.5V

	H mm	L mm	S mm	€		
1693M 80	115	48	29	230,00	1	016930080

## 1694/L

fitas métricas longas caixa em ABS anti-choque, fita em fibra de vidro revestida a PVC, classe de precisão III

CE

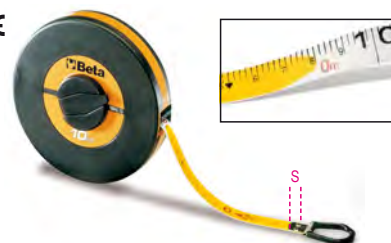

	L m	S mm	€		
1694L10	10	13	14,20	1	016940110
1694L20	20	13	17,60	1	016940120



### 1694A/L

fita métrica com punho, caixa em ABS anti-choque, fita em fibra de vidro revestida a PVC, classe de precisão III



	L m	S mm	€		
1694A/L30	30	13	35,00	1	016940230
1694A/L50	50	13	46,00	1	016940250

### 1694B/L

fitas métricas com punho caixa em ABS anti-choque, fita em fibra de vidro revestida a PVC, classe de precisão II



	L m	S mm	€		
1694B/L50	50	12,5	70,50	1	016940350

### 1695XS

nível de bolso com base magnética em V em alumínio  
2 bolhas inquebráveis  
precisão: 1mm/m



L mm	H mm	S mm	€		
70	48,5	20	14,20	5	016950250

### 1696

níveis com bolhas inquebráveis e corpo em perfil de alumínio anodizado – precisão: 1 mm/m



L mm	H mm	S mm	€		
200	50	19	23,80	2	016960002
400	50	19	27,50	2	016960004
500	50	19	30,00	2	016960005
600	50	19	32,00	2	016960006
800	50	19	40,00	2	016960008
1000	50	19	44,50	2	016960010

### 1696A

nível em alumínio moldado sobre pressão, envernizado, com 1 base rectificada e 2 bolhas invioláveis, precisão de 1 mm/m



L mm	H mm	S mm	€		
300	43	23	34,00	2	016960103
400	43	23	36,00	2	016960104
500	43	23	39,50	2	016960105
600	43	23	43,00	2	016960106
1000	43	23	86,50	1	016960110

### 1696B

nível magnético corpo em perfil de alumínio anodizado, 2 bolhas invioláveis, precisão de 1 mm/m



L mm	H mm	S mm	€		
200	49	22	37,00	2	016960202
300	49	22	38,50	2	016960203
400	49	22	40,50	2	016960204
500	49	22	49,00	2	016960205
600	49	22	52,00	2	016960206

### 1696D

níveis em alumínio anodizado com pegas, 4 bases e 3 bolhas inquebráveis, precisão: 1 mm/m



L mm	H mm	S mm	€		
300	47	25	32,00	2	016960353
400	47	25	36,00	2	016960354
500	47	25	39,50	2	016960355
600	47	25	44,50	2	016960356

### 1696S

níveis de pedreiro em alumínio com 2 bolhas inquebráveis  
precisão: 1 mm/m



L mm	H mm	S mm	€		
1500	90	25	114,00	1	016960415
2000	90	25	135,00	1	016960420
2500	90	25	169,00	1	016960425
3000	90	25	190,00	1	016960430

### 1696T

nível de bolha com base magnética, em alumínio perfilado, com 3 bolhas inquebráveis

- Base com perfil em V
- Precisão: 0,5 mm/m
- Com janela de leitura vertical

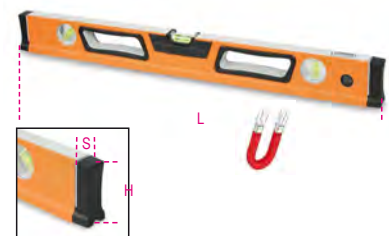

L mm	H mm	S mm	€		
600	66	28	83,00	2	016960506
800	66	28	92,50	2	016960508
1000	66	28	97,50	1	016960510
1200	66	28	122,00	1	016960512

## 1697

laser linhas cruzadas,  
30 metros, linhas verdes,  
com base magnética e suporte de parede,  
em estojo

### Características técnicas:

- autonivelamento das linhas cruzadas
- função de autonivelamento pode ser desligada para utilização manual
- laser diodo 515 Nm, classe 2
- alcance: 30 m
- precisão de medição:  $\pm 1$  mm a 5 m
- amplitude autonivelamento:  $3^\circ \pm 0.5^\circ$

- corpo em borracha ABS antiderrapante
- 1/4" encabadouro fêmea
- pilhas 2xAA
- autonomia: 4 horas

### BASE:

- 1 base magnética para utilização individual e combinada, 1/4" encabadouro macho
- 1 suporte de aperto ajustável para vários perfis de madeira e metal (para utilização em combinação com a base magnética)
- alinhamento horizontal e vertical rápido num ângulo de  $90^\circ$

CE



IP55

H	L	S	€	🔧	📦
mm	mm	mm			
82	57	89,5	281,00	1	016970030

320x230x90 mm

## 1699L

nível linear de precisão em ferro fundido  
com base prismática rectificada,  
2 bolhas invioláveis  
precisão de 0,05 mm/m



DIN 877

L	A	€	🔧	📦
mm	mm			
1699L	200	49	340,00	1 016990002

## 1699L/1

nível linear de precisão em ferro fundido  
com base prismática rectificada,  
2 bolhas invioláveis em caixa de madeira  
precisão de 0,02 mm/m



DIN 877

L	A	€	🔧	📦
mm	mm			
1699L/1	200	49	361,00	1 016990005

## 1699Q

nível quadrado de precisão  
em ferro fundido com 2 bases prismáticas  
e 2 bases planas rectificadas  
e 2 bolhas invioláveis  
precisão de 0,05 mm/m



DIN 877

L	A	€	🔧	📦
mm	mm			
150	40	481,00	1	016990015
200	48	605,00	1	016990020

## 1700N

ponteiros para pedreiro



L	S	€	🔧	📦
mm	mm			
250	16	18,80	5	017000005
300	16	20,30	5	017000006

## 1700N/PM

ponteiros para pedreiro  
com punho de protecção



L	S	€	🔧	📦
mm	mm			
250	16	25,00	2	017000105
300	16	29,50	2	017000106

## 1701N

cinzeis para pedreiro



L	A	S	€	🔧	📦
mm	mm	mm			
250	23	16	20,20	5	017010001
300	23	16	21,70	5	017010003

## 1701N/PM

cinzeis para pedreiro  
com punho de protecção



L	A	S	€	🔧	📦
mm	mm	mm			
250	23	16	26,00	2	017010101
300	23	16	29,50	2	017010103

## 1701PMR

punhos de protecção  
para artigos 1700N e 1701N



D	L	€	🔧	📦
mm	mm			
16	115	12,10	1	017010206

## 1701NE/...

cinzeis para electricistas



	SxL	€	🔧	📦
	mm			
1701NE3	10x200	12,50	5	017010406
1701NE4	10x250	13,20	5	017010409

## 1702N

talhadeiras largas



A	SxH	€	🔧	📦
mm	mm			
50	13x23	26,50	2	017020005
70	13x23	27,00	2	017020007

## 1702N/PM

talhadeiras largas  
com punho de protecção



A	SxH	€	🔧	📦
mm	mm			
50	13x23	32,00	2	017020105
70	13x23	35,50	2	017020107



Aconselhamos uma refrigeração constante da lâmina durante o re-afiação

## 1702PMR

punho de protecção para artigo 1702N



L	€	🔧	📦
mm			
115	9,40	1	017020200



## 1704

pés-de-cabra

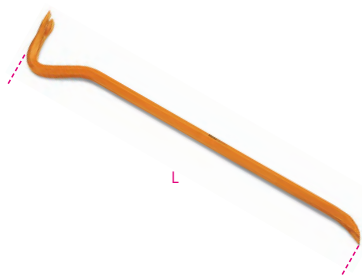

L mm	6 mm	mm	mm	€		
500	16	35	28	34,00	2	017040050
600	16	34	26	38,00	2	017040060
800	18	38	29	53,50	2	017040080

## 1704A

pés-de-cabra com extremidades abertas e pontiagudas endurecidas e temperadas

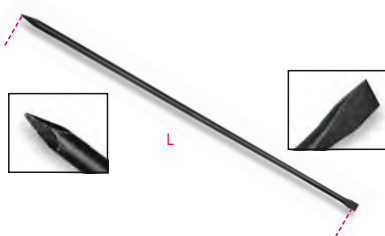

L mm	Ø	mm	€		
1500	25	45	115,00	1	017040110
2000	25	55	135,00	1	017040120

## 1704C

alavanca com extremidades pontiaguda e chata fechada



L mm	8 min-MAX mm	mm	€		
1200	21-31	39	116,00	1	017040210
1400	31-37	42	139,00	1	017040212
1600	25-37	42	172,00	1	017040215

## 1705

traçador de linhas em alumínio



L m	€		
1705	30	22,70	4 017050001

## 1705PT

pó para traçagem

- recipiente com dispensador
- azul



g	€		
250	14,70	5	017050025

## 1706DGT

Instrumento digital de medição da profundidade das ranhuras dos pneus



1706DGT	€		
	42,50	1	017060011

## 1707

conta-fios

rosca métrica ISO a 60° e Whitworth a 55°



P (ISO)	W	€		
0,25÷6	62÷4x1"	19,10	5	017070001

## 1707A/1 - 2 - 3

medidor de raios, lâminas côncavas e convexas em aço



	R mm	L mm	n	€		
1707A/1	1,0÷7,0	70	34	29,00	2	017070007
1707A/2	7,5÷15	85	32	31,50	2	017070015
1707A/3	15,5÷25	85	30	31,50	2	017070025

## 1708/8 - 13 - 20

apalpa-folgas

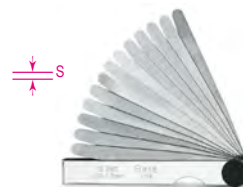

	€		
1708/8 S = 0,05±0,50 mm	7,30	5	017080008
1708/13 S = 0,05±1,00 mm	8,20	5	017080013
1708/20 S = 0,05±1,00 mm	13,30	5	017080020

## 1709/10 - 1709/18

quebra porcas



	L mm	A max mm	€		
1709/10	82,5	17 (M10)	62,00	1	017090010
1709/18	107,8	24 (M16)	68,50	1	017090018

## 1710

quebra porcas hidráulico



	A min mm	A max mm	€		
1710	7 (M4)	22 (M14)	284,00	1	017100001

## 1712E/1 - 2 - 3

pesca peças magnético

F = força magnética



	L mm	D mm	F kg	€		
1712E/1	420	7,5	0,5	36,50	2	017120011
1712E/2	530	15	1,8	46,50	2	017120012
1712E/3	532	19	3,0	57,50	2	017120013

## 1712TF

Iman telescópico com cabeça flexível

- Com anilha de limpeza a jacto



	L mm	D mm	F kg	€		
1712TF	150÷590	11	1	24,20	1	017120600

## 1712TFS

ímã telescópico com cabeça flexível

F= força magnética



L	D	F	€	🔧	📦
mm	mm	kg			
135÷570	5	0,4	20,80	1	017120595

## 1713M

pesca peças magnético

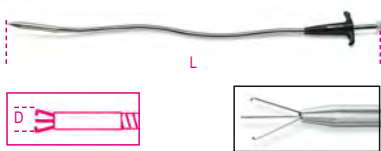

L	D	€	🔧	📦
mm	mm			
500	7	51,00	2	017130011
1000	7	89,50	1	017130015

## 1713M/K7

kit de 7 ferramentas de inspeção para peças com encabadouro sextavado de 1/4"

kit inclui:

- 1 punho telescópico, comprimento 185-660 mm
- 1 espelho de inspeção retangular, 65x43 mm
- 1 espelho de inspeção redondo, Ø 52 mm
- 1 ímã, Ø 16.3 mm
- 1 luz LED ultra-brilhante
- 1 pescoço flexível (ref. 1713M)
- 1 bandeja magnética em aço inox
- 3 baterias LR44



1713M/K7	€	🔧	📦
180,00	1	017130100	

297x165x52 mm - 0,8 kg

## 1714

espelho de inspeção plástico



L	D	€	🔧	📦
mm	mm			
1714	155	4,45	5	017140001

## 1715

espelho telescópico orientável, corpo em metal cromado



1715	L	D	€	🔧	📦
	mm	mm			
	180÷540	30	38,00	1	017150001

## 1715FL/A

espelho quadrado



1715FL/A	L	A	B	€	🔧	📦
	mm	mm	mm			
	600	53	90	46,00	1	017150110

## 1715R/FL

jogo de 2 espelhos de substituição para artigos 1715FL/A e 1715FL/B

1715R/FL	€	🔧	📦
9,70	1	017150151	

## 1715FL/B

espelho rectangular com iluminação

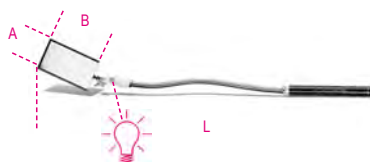

1715FL/B	L	A	B	€	🔧	📦
	mm	mm	mm			
	553	53	90	54,50	1	017150115

## 1715B/R5L

jogo de 5 lâmpadas de substituição para artigo 1715FL/B

1715B/R5L	€	🔧	📦
7,90	1	017150152	

## 1715I

espelho telescópico de inspeção com função de ampliação 5x

- Punho em PVC antiderrapante
- Espelho de inspeção e punho em aço inox



1715I	L	D	€	🔧	📦
	mm	mm			
	250÷720	55	35,50	1	017150020

## 1715L

espelho telescópico de inspeção com luz LED

- Corpo em aço inoxidável
- Tamanho de bolso, com clip
- Fornecido com 3 baterias L736F

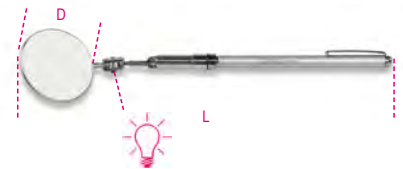

1715L	L	D	€	🔧	📦
	mm	mm			
	265÷765	50	56,00	1	017150005

## 1716A

raspador angular para uso genérico



1716A	L	L1	€	🔧	📦
	mm	mm			
	240	125	13,10	3	017160040

## 1716P

raspador para embalagens



1716P	L	L1	€	🔧	📦
	mm	mm			
	250	125	16,10	3	017160020

## 1716R

furador com ponta redonda



1716R	L	L1	D	€	🔧	📦
	mm	mm	mm			
	215	100	6	11,30	5	017160001

## 1716U

raspador em gancho para uso genérico



1716U	L	L1	D	€	🔧	📦
	mm	mm	mm			
	195	80	6	13,10	3	017160025

**1717A**  
rascador curvo



L mm	L1 mm	L2 mm	€	📦	📄
150	70	260	24,70	2	017170015
250	100	360	29,50	2	017170025

**1717B**  
rascador triangular



L mm	L1 mm	L2 mm	€	📦	📄
150	75	260	21,40	2	017170115
200	85	310	24,90	2	017170120

**1717C**  
rascador direito



L mm	S mm	L1 mm	€	📦	📄
150	18	270	21,20	2	017170215
200	20	320	23,70	2	017170220
250	25	370	26,50	2	017170225

**1717D**  
rascador direito de corte frontal



1717D	L mm	S mm	L1 mm	€	📦	📄
150	150	23	240	29,00	2	017170320



**1717T**  
raspadores triangulares, com 2 lâminas



1717T	L mm	€	📦	📄
310	310	13,60	1	017170610

**1717T RT**  
lâminas triangulares sobressalentes



1717T RT	L mm	€	📦	📄
65	65	2,79	1	017170660

**1717T RS**  
lâminas moldáveis sobressalentes



1717T RS	€	📦	📄
	2,79	1	017170661

**1717V**  
raspadores de pintura,  
lâminas para utilização em tamanhos diversos



	L mm	A mm	€	📦	📄
1717V 38	200	38	9,10	1	017170703
1717V 65	285	65	19,50	1	017170706

**1717V R**  
lâminas para referência 1717V



	L mm	€	📦	📄
1717V R38	38	2,79	1	017170753
1717V R65	65	4,00	1	017170756

**CORTES DE LIMAS DE ENGENHEIRO**

**Grossoiro**

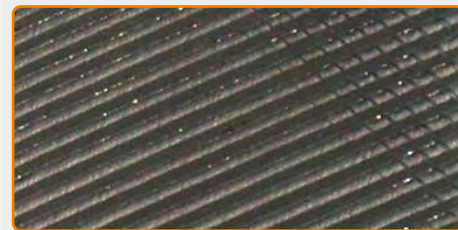

**Segundo corte**



**Suave**

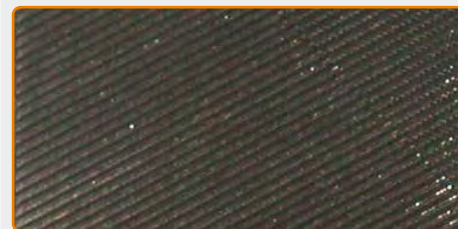

**1718D...Q**  
limas quadradas bastardas, sem punho

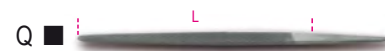

	L mm	L' mm	€	📦	📄
1718D6/Q	150	6	10,70	5	017180121
1718D8/Q	200	8	12,70	5	017180131
1718D10/Q	250	10	17,30	5	017180141

**1718A...Q**  
limas quadradas meia-murças, sem punho

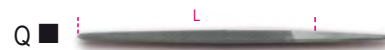

	L mm	L' mm	€	📦	📄
1718A6/Q	150	6	10,90	5	017180021
1718A8/Q	200	8	13,10	5	017180031
1718A10/Q	250	10	18,00	5	017180041

**1718D...T**  
limas triangulares bastardas, sem punho

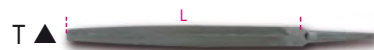

	L mm	L' mm	€	📦	📄
1718D6/T	150	6	12,80	5	017180123
1718D8/T	200	8	16,30	5	017180133
1718D10/T	250	10	21,50	5	017180143



## 1718A...T

limas triangulares meia-murças, sem punho

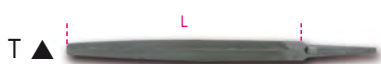

	L mm	L "	€		
1718A6/T	150	6	13,10	5	017180023
1718A8/T	200	8	16,70	5	017180033
1718A10/T	250	10	22,50	5	017180043

## 1718D...P

limas chatas bastardas, sem punho



	L mm	L "	€		
1718D6/P	150	6	10,10	5	017180125
1718D8/P	200	8	11,80	5	017180135
1718D10/P	250	10	15,90	5	017180145

## 1718A...P

limas chatas meia-murças, sem punho



	L mm	L "	€		
1718A6/P	150	6	10,70	5	017180025
1718A8/P	200	8	12,30	5	017180035
1718A10/P	250	10	17,30	5	017180045

## 1718D...M

limas meia-cana bastardas, sem punho



	L mm	L "	€		
1718D6/M	150	6	14,10	5	017180127
1718D8/M	200	8	17,40	5	017180137
1718D10/M	250	10	22,50	5	017180147

## 1718A...M

limas meia-cana bastardas, sem punho



	L mm	L "	€		
1718A6/M	150	6	14,30	5	017180027
1718A8/M	200	8	17,80	5	017180037
1718A10/M	250	10	23,70	5	017180047

## 1718D...R

limas redondas bastardas, sem punho



	L mm	L "	€		
1718D6/R	150	6	10,10	5	017180129
1718D8/R	200	8	11,80	5	017180139
1718D10/R	250	10	15,50	5	017180149

## 1718A...R

limas redondas meia-murças, sem punho

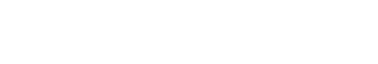

	L mm	L "	€		
1718A6/R	150	6	10,70	5	017180029
1718A8/R	200	8	12,30	5	017180039
1718A10/R	250	10	16,40	5	017180049

## 1718D...S5

jogo de 5 limas bastardas, sem punhos



■ Q  
▲ T  
I P  
▷ M  
● R

	L mm	L "	€		
1718D6/S5	150	6	57,50	1	017180130
1718D8/S5	200	8	70,00	1	017180140
1718D10/S5	250	10	93,00	1	017180150

## 1718A...S5

jogo de 5 limas meia-murças, sem punhos



■ Q  
▲ T  
I P  
▷ M  
● R

	L mm	L "	€		
1718A6/S5	150	6	59,50	1	017180030
1718A8/S5	200	8	72,00	1	017180040
1718A10/S5	250	10	98,00	1	017180050

## 1719BMD...Q

limas quadradas bastardas, com punho



	L mm	L "	€		
1719BMD6/Q	150	6	14,50	5	017190191
1719BMD8/Q	200	8	16,10	5	017190221
1719BMD10/Q	250	10	22,10	5	017190241
1719BMD12/Q	300	12	29,00	3	017190325

## 1719BMA...Q

limas quadradas meia-murças, com punho



	L mm	L "	€		
1719BMA6/Q	150	6	14,70	5	017190021
1719BMA8/Q	200	8	17,60	5	017190052
1719BMA10/Q	250	10	22,90	5	017190071
1719BMA12/Q	300	12	34,00	3	017190311

## 1719BMX...Q

limas quadradas murças, com punho



	L mm	L "	€		
1719BMX6/Q	150	6	15,60	5	017190022
1719BMX8/Q	200	8	20,20	5	017190053
1719BMX10/Q	250	10	27,50	5	017190072

## 1719BMD...T

limas triangulares bastardas, com punho



	L mm	L "	€		
1719BMD6/T	150	6	17,40	5	017190193
1719BMD8/T	200	8	19,90	5	017190223
1719BMD10/T	250	10	27,00	5	017190243
1719BMD12/T	300	12	38,00	3	017190326

## 1719BMA...T

limas triangulares meia-murças, com punho



	L mm	L "	€		
1719BMA6/T	150	6	17,40	5	017190023
1719BMA8/T	200	8	21,50	5	017190054
1719BMA10/T	250	10	28,00	5	017190073
1719BMA12/T	300	12	40,00	3	017190313

## 1719BMX...T

limas triangulares murças, com punho



	L mm	L "	€		
1719BMX6/T	150	6	20,50	5	017190024
1719BMX8/T	200	8	27,00	5	017190055
1719BMX10/T	250	10	34,50	5	017190074

## 1719BMD...P

limas chatas bastardas, com punho



	L mm	L "	€		
1719BMD6/P	150	6	14,50	5	017190195
1719BMD8/P	200	8	15,30	5	017190225
1719BMD10/P	250	10	21,60	5	017190245
1719BMD12/P	300	12	28,50	3	017190327

## 1719BMA...P

limas chatas meia-murças, com punho



	L mm	L "	€		
1719BMA6/P	150	6	15,30	5	017190025
1719BMA8/P	200	8	17,40	5	017190056
1719BMA10/P	250	10	22,40	5	017190075
1719BMA12/P	300	12	32,00	3	017190315

## 1719BMX...P

limas chatas murças, com punho



	L mm	L "	€		
1719BMX6/P	150	6	15,60	5	017190026
1719BMX8/P	200	8	20,50	5	017190057
1719BMX10/P	250	10	27,00	5	017190076

## 1719BMD...M

limas meia-cana bastardas, com punho



	L mm	L "	€		
1719BMD6/M	150	6	19,10	5	017190197
1719BMD8/M	200	8	20,50	5	017190227
1719BMD10/M	250	10	28,00	5	017190247
1719BMD12/M	300	12	38,50	3	017190328

## 1719BMA...M

limas meia-cana meia-murças, com punho



	L mm	L "	€		
1719BMA6/M	150	6	19,90	5	017190027
1719BMA8/M	200	8	23,30	5	017190058
1719BMA10/M	250	10	30,00	5	017190077
1719BMA12/M	300	12	42,50	3	017190317

## 1719BMX...M

limas meia-cana murças, com punho



	L mm	L "	€		
1719BMX6/M	150	6	21,20	5	017190028
1719BMX8/M	200	8	26,00	5	017190059
1719BMX10/M	250	10	36,50	5	017190078

## 1719BMD...R

limas redondas bastardas, com punho



	L mm	L "	€		
1719BMD6/R	150	6	14,50	5	017190199
1719BMD8/R	200	8	15,10	5	017190229
1719BMD10/R	250	10	21,10	5	017190249
1719BMD12/R	300	12	28,00	3	017190329

## 1719BMA...R

limas redondas meia-murças, com punho



	L mm	L "	€		
1719BMA6/R	150	6	15,40	5	017190029
1719BMA8/R	200	8	17,20	5	017190060
1719BMA10/R	250	10	21,80	5	017190079
1719BMA12/R	300	12	29,50	3	017190319

## 1719BMX...R

limas redondas murças, com punho



	L mm	L "	€		
1719BMX6/R	150	6	17,80	5	017190031
1719BMX8/R	200	8	19,90	5	017190061
1719BMX10/R	250	10	27,00	5	017190081

## 1719BMA...B5

conjunto de 5 limas meia-murça, com punho, em bolsa



	L mm	L "	€		
1719BMA8/B5	200	8	96,50	1	017190297
1719BMA10/B5	250	10	125,00	1	017190298

## 1719BMD...B5

conjunto de 5 limas bastardas, com punho, em bolsa



	L mm	L "	€		
1719BMD8/B5	200	8	87,00	1	017190303
1719BMD10/B5	250	10	120,00	1	017190305

## 1719BMD...S5

jogo de 5 limas bastardas, com punhos



	L mm	L "	€		
1719BMD6/S5	150	6	80,50	1	017190200
1719BMD8/S5	200	8	87,00	1	017190230
1719BMD10/S5	250	10	120,00	1	017190250
1719BMD12/S5	300	12	162,00	1	017190363

## 1719BMA...S5

jogo de 5 limas meia-murça, com punhos



	L mm	L "	€		
1719BMA6/S5	150	6	82,50	1	017190030
1719BMA8/S5	200	8	96,50	1	017190070
1719BMA10/S5	250	10	125,00	1	017190080
1719BMA12/S5	300	12	178,00	1	017190361

## 1719BMX...S5

jogo de 5 limas murças, com punhos



	L mm	L "	€		
1719BMX6/S5	150	6	90,50	1	017190032
1719BMX8/S5	200	8	114,00	1	017190069
1719BMX10/S5	250	10	152,00	1	017190082

## 1719BMB/P

limas chatas universais,  
punhos em material plástico



L mm	L"	€	U	U
250	10	34,50	5	017190152
300	12	40,50	5	017190153

## 1719BMC

limas meia-cana e chatas,  
punhos em material plástico



UNI 5569 - UNI 5568

	L mm	L"	€	U	U
1719BMC/M 250	250	10	22,90	6	017190252
1719BMC/M 300	300	12	29,00	4	017190253
1719BMC/P 250	250	10	18,10	6	017190262
1719BMC/P 300	300	12	22,40	4	017190263

## 1719BM/RL

lima chata paralela  
1 lado áspero segundo corte,  
1 lado lima grão grosso  
punho em plástico



	L mm	L"	€	U	U
1719BM/RL	200	8	18,10	5	017190360

## 1719BM/RR

lima redonda,  
punho em plástico



	L mm	L"	€	U	U
1719BM/RR	200	8	19,00	5	017190351

## 1719BM/RG

lima meia-cana,  
punho em plástico



	L mm	L"	€	U	U
1719BM/RG	200	8	18,80	5	017190353

## 1719BM/RP

lima chata,  
punho em plástico



L mm	L"	€	U	U
200	8	19,30	5	017190352

## 1719BMR/B3

jogo de 3 limas meia-murça,  
com punhos,  
em estojo para pendurar



L mm	L"	€	U	U
200	8	57,50	1	017190358

## 1719BMR

punho para limas



	L mm	A mm	€	U	U
1719BMR/0	95	25	4,15	10	017190950
1719BMR/0B	110	29	4,15	10	017190955
1719BMR/1	110	29	4,15	10	017190951
1719BMR/1B	110	29	4,15	10	017190953
1719BMR/2	123	31	4,15	10	017190952
1719BMR/2B	123	31	4,15	10	017190954

	mm	"	
1719BMR/0	100/150	4/6	▲▶
1719BMR/0B	100/150	6/8	■●
1719BMR/1	150/200	6/8	▲▶
1719BMR/1B	150/200	6/8	■●
1719BMR/2	250/300	10/12	▲▶
1719BMR/2B	250/300	10/12	■●



## 1720/...

limas de calado

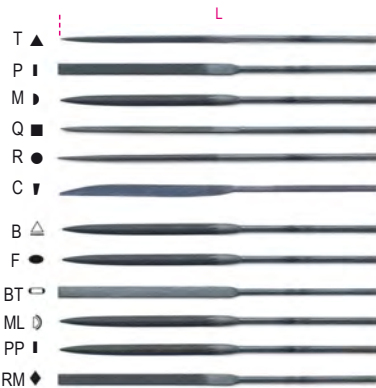

UNI 5569 UNI 5670

	L mm	€	U	U
1720T	160	8,40	5	017200004
1720P	160	8,40	5	017200006
1720M	160	8,40	5	017200008
1720Q	160	8,40	5	017200009
1720R	160	8,40	5	017200010
1720C	160	8,40	5	017200012
1720B	160	8,40	5	017200005
1720ML	160	8,40	5	017200007
1720BT	160	8,40	5	017200011
1720F	160	8,40	5	017200013
1720PP	160	8,40	5	017200014
1720RM	160	8,40	5	017200015



	€	U	U
1720/S3	25,00	1	017200000

## 1720/B



	€	U	U
1720/B6	52,50	1	017200002
1720/B12	101,00	1	017200003

## 1720D/...

limas de calado diamantadas



	L mm	€	U	U
1720D/T	160	54,00	2	017200104
1720D/P	160	54,00	2	017200106
1720D/M	160	54,00	2	017200108
1720D/Q	160	54,00	2	017200109
1720D/R	160	54,00	2	017200110
1720D/C	160	54,00	2	017200112





1720D/B6 € 326,00 1 017200120

### 1721/B6

jogo de 6 limas para contactos em bolsa de plástico



1721/B6 € 28,00 1 017210010

### 1723

saca-molas



1723 L mm 210 € 18,10 5 017230001

### 1725

serrote



1725 L mm 420 L1 mm 300 € 23,70 4 017250001

### 1725CR

mini serrote



1725CR L mm 250 L1 mm 150 € 13,00 5 017250010

### 1726

serrote, sistema tensor da folha incorporado no punho

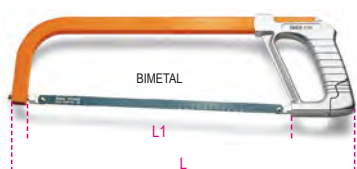

1726 L mm 440 L1 mm 300 € 31,50 4 017260001

### 1726BM

Serrote com sistema de substituição rápida da lâmina

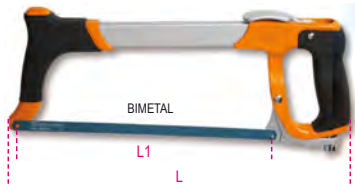

1726BM L mm 400 L1 mm 300 € 51,00 1 017260050

### 1727

serrote, série pesada

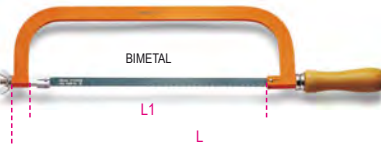

1727 L mm 515 L1 mm 300 € 21,80 4 017270001

### 1727BM

serrote, trabalho com uma mão



1727BM L mm 315 L1 mm 300 € 26,50 5 017270020

### 1728...

folhas de serra



1728LA € 1,54 100 017280001  
 1725CR  
 1725MQ  
 1728BM € 3,90 100 017280010  
 1725-1726  
 1727-1727M  
 1728CO € 5,40 50 017280030  
 1725-1726  
 1727-1727M

### 1729CG

serra para gesso cartonado



1729CG L mm 310 L1 mm 160 € 26,00 2 017290200

### 1729DM 450

serra para madeira

dentado médio, 12 dentes/polegadas



1729DM 450 L mm 450 L1 mm 400 € 29,50 4 017290450

### 1729J

serra japonesa, lâmina flexível

17 dentes por polegada



1729J L mm 405 L1 mm 235 € 39,50 4 017290400

### 1729MF

serra multifunções

Kit inclui:

- Lâmina para metal de 24 TPI
- Lâmina para gesso cartonado de 6 TPI
- Lâmina dupla para plástico de 11 TPI e madeira de 16 TPI



1729MF € 26,00 1 017290500

### 1729MF/CG

5 lâminas de 6 TPI para gesso cartonado para serra multifunções 1729MF



1729MF/CG € 12,50 4 017290502

### 1729MF/J

2 lâminas duplas de 16 TPI para madeira e 11 TPI para plástico para a serra multifunções 1729MF



1729MF/J € 18,70 4 017290501

## 1729MF/M

5 lâminas de 24 TPI para metal para serra multifunções 1729MF



1729MF/M € 13,50 4 017290503

## 1730

espátulas universais, com punho e lâminas em aço inox



S mm	L mm	L1 mm	€	Q	Art.
38	210	85	7,00	2	017300038
63	220	95	8,30	2	017300063
75	220	95	9,00	2	017300075
100	220	95	10,40	2	017300100

## 1736A

escova de aço para limas



1736A L mm 240 € 12,60 10 017360010

## 1737

escovas em latão



1737 L mm 145 € 6,20 10 017370001

## 1737NX

escova curva em aço



1737NX L mm 270 € 7,40 5 017370010

## 1737AC

escova em aço



1737AC L mm 275 € 7,00 5 017370020

## 1737B

pares de escovas de limpeza de terminais e bornes de baterias



1737B € 17,20 1 017370050

## 1738

pincel



1738 L mm 210 H mm 30 € 10,00 10 017380001

## 1739C

rebitadora extensível, fornecida com 5 bicos intercambiáveis



Ø mm	3,2	4	4,8	5	6	6,4
Alumínio	•	•	•	•	•	•
Aço inoxidável	•	•	•	•		

1739C L max mm 810 € 139,00 1 017390152



## 1740AN

rebitadora para trabalhos pesados, fornecida com 5 bicos intercambiáveis • com reservatório de rebites



Ø mm	3,2	4	4,8	5	6	6,4
Alumínio	•	•	•	•	•	•
Aço inoxidável	•	•	•	•		

1740AN L mm 530 € 126,00 1 017400103

## 1740B

alicate de cravagem para trabalhos pesados, fornecido com 5 pontas intercambiáveis



Ø mm	2,4	3	3,2	3,2	4,8
Alumínio	•	•	•	•	•
Aço	•	•	•	•	•
Aço inoxidável	•	•	•	•	•

1740B 280 L mm 280 € 81,50 1 017400280

Ø mm	2,4	3,2	4,0	4,8	6,4
Alumínio	•	•	•	•	•
Aço	•	•	•	•	•
Aço inoxidável	•	•	•	•	•

1740B 330 L mm 330 € 94,50 1 017400330



## 1741

alicate de rebitar em liga leve

fornecido com 4 bicos intercambiáveis



266 mm

Ø mm	2,4	3,2	4	4,8	5
Alumínio	•	•	•	•	•
Aço	•	•	•	•	•
Aço inoxidável	•	•	•		

1741 € 41,00 1 017410003

## 1741/C5

alicate de rebitar 1741 com jogo de 700 rebites em alumínio



1741/C5 € 131,00 1 017410035

	Ø mm	L mm	n.
1741RV2,9K	3,0	6	200
1741RV3,2K	3,2	8	200
1741RV3,8K	4,0	10	100
1741RV4K	4,0	12	100
1741RV4,8K	4,8	12	100

420x160x60 mm - 3150 g

## 1741P

alicate de rebitar para serviços pesados

fornecido com 4 bicos intercambiáveis



260 mm

Ø mm	2,4	3,2	4	4,8	5
Alumínio	•	•	•	•	•
Aço	•	•	•	•	•
Aço inoxidável	•	•	•		

1741P € 57,00 1 017410303

## 1741TR

alicate de rebitar com cabeça rotativa

com 4 bicos intercambiáveis



285mm



Ø mm	2,4	3	3,2	4	4,8
Alumínio	•	•	•	•	•
Aço	•	•	•	•	•
Aço inoxidável	•	•	•	•	•

1741TR € 44,50 1 017410410

## 1741U

alicate de rebitar compacto com força ajustável

com 4 bicos intercambiáveis

3 pernas: melhor fixação do rebite



200 mm

Ø mm	2,4	3	3,2	4	4,8
Alumínio	•	•	•	•	•
Aço	•	•	•	•	•
Aço inoxidável	•	•	•	•	•

1741U € 51,00 1 017410450

## 1741RV...K

rebites em alumínio

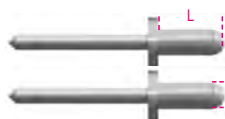

1741RV 2,9K	ØxL = 3x6 mm	€ 21,60	1 017410191
1741RV 3,2K	ØxL = 3,2x8 mm	€ 22,30	1 017410192
1741RV 3,8K	ØxL = 4x10 mm	€ 28,00	1 017410193
1741RV 4K	ØxL = 4x12 mm	€ 30,50	1 017410194
1741RV 4,8K	ØxL = 4,8x12 mm	€ 38,00	1 017410195

Os preços indicados são para 500 unidades

## 1742N

alicate de cravar porcas, fornecido com 4 bicos intercambiáveis e 4 pinos (1x M3;M4;M5;M6)



250 mm

1742N € 143,00 1 017420002

	Ø mm	L mm
3	5	11
4	6	11
5	7	13
6	9	17

## 1742N/KR

kit de 4 pinos de substituição para artigo 1742N



M3	€ 61,50	1 017420063
M4	€ 61,50	1 017420064
M5	€ 61,50	1 017420065
M6	€ 61,50	1 017420066

## 1742R-AL/M...

rebites roscados em alumínio para itens 1742-1742A-1946KF



1742R-AL M3	ØxL = 5x10 mm M = 3	€ 5,40	1 017420023
1742R-AL M4	ØxL = 6x12 mm M = 4	€ 5,50	1 017420024
1742R-AL M5	ØxL = 7x13 mm M = 5	€ 5,90	1 017420025
1742R-AL M6	ØxL = 9x15 mm M = 6	€ 7,10	1 017420026

Os preços indicados são para 20 unidades





## 1742R-A/M...

rebites roscados em aço para itens 1742-1742A-1946KF



1742R-A M3	€ 5,70	1	017420013
ØxL = 5x11 mm M = 3			
1742R-A M4	5,80	1	017420014
ØxL = 6x11 mm M = 4			
1742R-A M5	6,10	1	017420015
ØxL = 7x13 mm M = 5			
1742R-A M6	7,30	1	017420016
ØxL = 9x17 mm M = 6			
1742R-A M8	6,90	1	017420018
ØxL = 11x17 mm M = 8			
1742R-A M10	8,30	1	017420020
ØxL = 13x24 mm M = 10			
1742R-A M12	9,30	1	017420022
ØxL = 12x24 mm M = 12			

Os preços indicados são para 20 unidades  
• Os preços indicados são para 10 unidades

## 1742N/C4

alicate de cravar porcas 1742N com jogo de 400 porcas em aço



1742N/C4	€ 319,00	1	017420006
----------	----------	---	-----------

	M	Ø mm	n.
1742R-A/M3	3	5	100
1742R-A/M4	4	6	100
1742R-A/M5	5	7	100
1742R-A/M6	6	9	100

415x155x60 mm - 2,9 kg

## 1742AN

alicate de cravar porcas para trabalhos pesados, fornecido com 7 bicos intercambiáveis



1742AN	€ 450,00	1	017420101
--------	----------	---	-----------

M	Ø mm	L mm
3	5	13
4	6	13
5	7	13
6	9	17
8	11	17
10	13	24
12	15	24

## 1742AN/KR

kit de 4 pinos de substituição para artigo 1742AN



1742AN/KR M3	M3	€ 41,50	1	017420153
1742AN/KR M4	M4	41,50	1	017420154
1742AN/KR M5	M5	41,50	1	017420155
1742AN/KR M6	M6	41,50	1	017420156
1742AN/KR M8	M8	41,50	1	017420158
1742AN/KR M10	M10	41,50	1	017420160
1742AN/KR M12	M12	41,50	1	017420162

## 1742AN/C

alicate de cravar porcas para trabalhos pesados 1742AN com jogo de 80 porcas em aço



1742AN/C	€ 525,00	1	017420106
----------	----------	---	-----------

	M	Ø mm	n.
1742R-A/M3	3	5	5
1742R-A/M4	4	6	10
1742R-A/M5	5	7	20
1742R-A/M6	6	9	20
1742R-A/M8	8	11	10
1742R-A/M10	10	13	10
1742R-A/M12	12	15	5

420x240x80 mm - 2,5 kg

## 1749

pistola para isolantes envernizada



1749	L min mm 340	€ 16,10	2	017490001
------	--------------	---------	---	-----------

## 1749A

pistola para isolantes modelo profissional, corpo em alumínio



1749A	L min mm 360	€ 50,50	1	017490010
-------	--------------	---------	---	-----------

## 1749A/RB

câmara de substituição para artigo 1749A

1749A/RB	€ 1,16	1	017490051
----------	--------	---	-----------

## 1749A/RT

placa de pressão para artigo 1749A

1749A/RT	€ 2,54	1	017490052
----------	--------	---	-----------

## 1749AC

pistola injectora para produtos químicos



1749AC	L min mm 360	€ 44,50	1	017490005
--------	--------------	---------	---	-----------

## 1750

pistola de massa

Pode ser utilizada com cartucho 1750CG ou massa a vulso



1750 500	€ 49,50	1	017500500
1750 750	58,50	1	017500750

## 1750R/1 - 1750R/2

tubos flexíveis de substituição Nylon



	L mm	€		
1750R/1	310	7,90	2	017500030
1750R/2	410	8,80	2	017500040

## 1750RC

ponteira rígida curva



	L mm	M mm	€		
1750RC	150	10x1	6,50	2	017500050

## 1750RT

ponteira de lubrificação  
com 4 garras modelo hidráulico



	M mm	€		
1750RT	10x1	5,80	5	017500110

## 1750RP/1 - 1750RP/2

acoplamentos para ligações planas



	Ø mm	M mm	€		
1750RP/1	16	10x1	14,30	2	017500115
1750RP/2	22	10x1	32,00	2	017500120

## 1750PF

cartuchos de massa universais para artigo 1750

• Temperatura de funcionamento: -20 °C ÷ +130 °C



g	€		
400	17,50	18	017500141
550	21,80	18	017500161

## 1750KG10

Bomba de massa com balde de 10 kg  
com mangueira de alta pressão, 2 m

- Fornecido com união giratória, para evitar o estrangulamento da mangueira  
- Bomba em alumínio fundido com válvula de retenção

3 níveis de pressão disponíveis:

- 4 g - 275 bar
- 7 g - 206 bar
- 9 g - 137 bar



	€		
1750KG10	223,00	1	017500100

## 1750TA

Bico de alta pressão com bloqueio através de 6 pinos

Uma vez posicionado, permanece no eixo e conectado ao copo; não precisa de ser mantido como um bico comum  
Fácil de desconectar mesmo sob pressão  
Rosca intermédia universal M10x1: adequada para todos os tipos de pistolas de massa: elétrica, pneumática, manual etc.  
Sem deformação até 550 bar



	€		
1750TA	52,50	1	017500111

## 1750TLA

Bico de alta pressão com bloqueio através de 6 pinos, versão longa

- Uma vez posicionado, permanece no eixo e conectado ao copo  
- Fácil de desconectar mesmo sob pressão  
- Rosca intermédia universal M10x1: adequada para todos os tipos de pistolas de massa: elétrica, pneumática, manual etc.  
- Sem deformação até 550 bar



	€		
1750TLA	70,50	1	017500112

## 1750M

mini pistola de massa

• Com micro bocal  
• Particularmente adequada para ferramentas pneumáticas



	cc	D mm	L mm	€		
1750M	100	43	145	26,00	1	017500025

## 1750M3

mini pistola de massa, com 3 bicos

- equipada com três bicos intercambiáveis: 0,7 - 1,0 - 1,4 mm
- particularmente indicada para lubrificação de ferramentas pneumáticas
- pode ser utilizada com massa avulso
- adequada para utilização de massa até grau NLGI 2



	cc	Ø mm	L mm	€		
1750M3	85	42	160	34,50	1	017500003

## 1751CR

almotolia em metal, bico rígido



cc	D mm	L mm	€		
200	62	140	17,70	4	017510202
300	75	140	19,10	4	017510203
500	85	140	20,30	4	017510205
700	100	140	22,20	2	017510207
1000	100	140	24,10	2	017510210

## 1751N

almotolias metálicas,  
bico flexível



cc	D mm	L mm	€	📦	📄
200	62	140	18,70	4	017510020
300	75	140	20,30	4	017510030
500	85	140	21,30	4	017510050
700	100	140	23,20	2	017510075
1000	100	140	25,00	2	017510100

## 1752

almotolias plásticas bico rígido



cc	D mm	L mm	€	📦	📄
200	67	140	12,10	4	017520002
300	77	140	13,10	4	017520003
500	95	140	13,80	4	017520005

## 1754

almotolias plásticas bico flexível



cc	D mm	L mm	€	📦	📄
150	60	130	11,10	5	017540015
250	65	130	12,50	5	017540025

## 1755C

almotolia em plástico,  
bico curvado



cc	L mm	A mm	€	📦	📄
125	110	46	5,10	5	017550112
250	110	60	6,90	5	017550125
500	110	74	7,80	4	017550150

## 1755P

almotolia em plástico

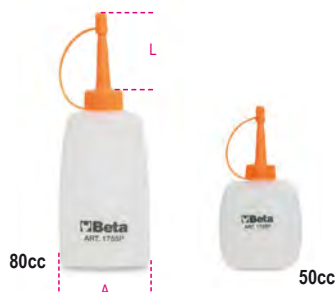

	cc	L mm	A mm	€	📦	📄
1755P 50	50	35	55	9,90	1	017550050
1755P 80	80	35	45	11,50	1	017550080

## 1756

oleador tipo caneta

adequado para utilização com óleos minerais



cc	L mm	€	📦	📄
5	140	26,50	2	017560001

## 1756B

oleador tipo caneta

- com serrilhado antiderrapante
- temperatura de funcionamento: -10 °C - +60 °C
- densidade mínima de óleo SAE 10



cc	L mm	€	📦	📄
500	280	25,50	2	017560220

## 1756V

oleador tipo caneta, 200 ml, em polipropileno

- Para transferir óleo e fluido de travões
- Temperatura de funcionamento: +0 ÷ +50 °C
- Não adequado para combustíveis e líquidos inflamáveis
- Densidade de óleo mínima utilizável; inferior a SAE 30



1756V	€ 45,50	📦 1	📄 017560504
-------	---------	-----	-------------

## 1756D

oleador tipo caneta, 1500 ml, em polipropileno

- Junta dupla NBR
- Temperatura de funcionamento: +0 - +50 °C
- NÃO adequado para combustível



1756D	€ 91,50	📦 1	📄 017560515
-------	---------	-----	-------------

## 1756E

oleador tipo caneta, compatível com gasolina



1756E	€ 47,00	📦 1	📄 017560610
-------	---------	-----	-------------

## 1756G

oleador tipo caneta  
capacidade: 1.5 l

- Adequado para:
- filtros de óleo diesel
  - depósitos Cerina



- Contém:
- 2 tubos com encaixe rápido fêmea para ligação de tubos de óleo diesel
  - 2 encaixes rápidos machos, em metal
  - 1 adaptador cônico para tubos de borracha

1756G	€ 140,00	📦 1	📄 017560615
-------	----------	-----	-------------



## 1756V-20R

O-rings (par) para oleadores 1756V



1756V-20R	€ 13,10			1 017560505
-----------	---------	--	--	-------------

## 1756D-20R

O-rings (par) para oleadores 1756D

1756D-20R	€ 8,70			1 017560516
-----------	--------	--	--	-------------

## 1757

reservatório para líquido de baterias



cc	D mm	€		
250	60	4,10	4	017570002
500	75	4,95	4	017570004
1000	90	6,90	2	017570006

## 1757A

reservatório para líquido de baterias



cc 2000	€ 50,50			1 017570020
---------	---------	--	--	-------------

## 1758

funil adaptável

Particularmente útil para veículos sem profundidade nos bujões



1758	€ 63,00			1 017580020
------	---------	--	--	-------------

## 1758ADB-D

funil de não-retorno para AdBlue®, com encaixe reto



1758 ADB-D	€ 40,50			1 017580050
------------	---------	--	--	-------------

## 1758ADB-45°

funil de não-retorno para AdBlue®, com encaixe 45°



1758 ADB-45	€ 43,00			1 017580060
-------------	---------	--	--	-------------

## 1758B

funil de não-retorno com encaixe rápido

Particularmente adequado para veículos VAG



1758B	€ 42,00			1 017580030
-------	---------	--	--	-------------

## 1758B-1,6

funil de não-retorno, 1600 ml, com encaixe rápido uniões rápidas para veículos do grupo VAG



1758B-1,6	H1 mm 125	H2 mm 100	Ø mm 155	€ 47,00			1 017580033
-----------	-----------	-----------	----------	---------	--	--	-------------

## 1758B-RNT

Encaixe de não retorno para funil de combustível item 1758B - 1758B-1,6

para motor Renault 1.5 dCi



1758B-RNT	€ 30,00			1 017580035
-----------	---------	--	--	-------------

## 1758B/K5

kit de encaixes rápidos de não-retorno, para funil de combustível 1758B - 1758B-1,6

Kit inclui:

- 1 adaptador para motores 1.5 dCi Renault, Dacia, Nissan
- 1 adaptador para motores 1.5/1.6 dCi Renault, Dacia, Nissan
- 1 adaptador para motores diesel 3.0 BMW
- 1 adaptador para motores gasolina 1.5/2.0, grupo VAG
- 1 adaptador de ligação para funil, com torneira



1758B/K5	€ 120,00			1 017580040
----------	----------	--	--	-------------

## 1758RD

funil de refrigerante com encaixe rápido



H	Ø	€	🔧	📦
248	172	130,00	1	017580070

## 1758S

suporte de parede para funis 1758 e encaixes rápidos



1758S	€	🔧	📦
	97,50	1	017580080

## 1758LG

folha de alumínio moldável, com revestimento em borracha, para canalização de líquidos



L	H	€	🔧	📦
365	168	53,50	1	017580006

## 1758M

Funil



1758M	L	€	🔧	📦
	350	15,90	1	017580000

## 1758R

reservatório para líquidos

Bico flexível, amovível e prático



	lt	€	🔧	📦
1758R 1	1	10,00	1	017580201
1758R 2	2	11,90	1	017580202
1758R 3	3	21,20	1	017580203
1758R 5	5	26,00	1	017580205

## 1758VT

kit de teste para cabeça do cilindro

Indica num curto espaço de tempo se o tanque de expansão contém dióxido de carbono.



1758VT	€	🔧	📦
	204,00	1	017580100

290x190x50 mm - 1kg

## 1758VT/L

líquido de teste para cabeça do cilindro



1758VT/L	€	🔧	📦
	58,50	1	017580101

## 1759

dispositivo óptico para análise de refrigerantes, baterias, limpa-vidros e fluidos AdBlue®

Fornecido em estojo rígido

Compensação automática de temperatura

Acido de bateria: intervalo de medição:

1.1÷1.3 kg/l

Refrigerante propileno: -25 °C ÷ -50 °C

Refrigerante etileno: -25 °C ÷ -50 °C

Limpa-vidros: -25 °C ÷ -40 °C

AdBlue: medição percentagem de ureia: 30% ÷ 45%



1759	€	🔧	📦
	189,00	1	017590251

## 1759A

densímetro para líquido anti-congelante



1759A	L	€	🔧	📦
	340	79,50	1	017590001

## 1759B

densímetro para líquido de baterias



1759B	L	€	🔧	📦
	280	52,00	1	017590005

## 1759HD/3

Kit ferramentas para detecção de fugas e enchimento rápido de sistemas de refrigeração

- Para detecção de fugas do circuito de refrigeração (tubos, juntas, bombas, radiadores) e enchimento rápido, prevenindo a formação de bolhas de ar



1759HD/3 € 665,00 1 017590063  
 600x500x140 mm - 6,5 kg

## 1759LR

ferramenta de lavagem com sistema de arrefecimento

utilizando ar comprimido, a alta pressão da água proporciona um sistema de lavagem eficiente

- fornecido com 6 adaptadores de ligação ao sistema
- alavanca com bloqueio de posição para utilização contínua
- fornecida com adaptador rápido para água



1759LR L 402 mm € 510,00 1 017590070  
 390x330x100

## 1759HD/TRUCK

ferramenta de teste e vedante para sistema de refrigeração em veículos pesados



1759HD/RR € 204,00 1 017590064  
 450x310x110 mm - 2,2 kg



1759HD/TRUCK € 462,00 1 017590065  
 440x330x100 mm - 3 kg

## 1759TT

Kit de 4 pares de tampões para detecção de fugas no turbo para utilização com punho de encher pneus



1759TT € 245,00 1 017590300  
 400x160x100 mm - 1,8 kg

# SERVIÇO DE CERTIFICAÇÃO PARA INSTRUMENTOS ELETRÔNICOS

A certificação de instrumentos de medição como Multímetros, Grampos Amperímetros, **Tacômetros e Termômetros** é essencial nos setores ou campos de aplicação em que são essenciais medições precisas, inequívocas e perceptíveis.

Para termômetros de infravermelhos é emitido um relatório de calibragem de 4 pontos (mínimo, máximo e dois pontos intermédios) com rastreamento ENAC.

**A Beta Utensili S.p.A. fornece o serviço de certificação a pedido. Para requerer este serviço, contacte o seu revendedor.**





**1760DGT**  
multímetro digital auto

CE



195 mm

92 mm

**CARACTERÍSTICAS TÉCNICAS**

RPM (tacómetro):  
Para motores de 2 e 4 cilindros  
RPM4 600 - 4000 RPM  
RPM4 600 - 12000 RPM (x10 RPM)  
RPM2/DIS 300 - 4000 RPM  
RPM2/DIS 300 - 6000 RPM (x10 RPM)  
Ângulo excêntrico: 4-8 CYL  
Tensão DC: 400mV-4/40/400/1000V  
Tensão AC: 4/40/400/700V  
Corrente DC: 40/400mA-4/20A  
Corrente AC: 40/400mA-4/20A  
Resistência: 400Ω-4/40/400kΩ-4/40MΩ  
Capacidade: 40/400nF-4/40/100μF  
Frequência: 5/50/500Hz-50/500-10MHz  
Ciclo de trabalho: 0.1% - 99.9%  
Amplitude de impactos: 1 - 10ms  
Teste diodo: Corrente de teste 0.3mA  
Continuidade: <150Ω - Corrente de teste <0.3mA  
Visor: Alto-contraste, backlight 4-digít LCD  
Sobrevoltagem: Categoria II 1000V  
Encerramento automático: 30 minutos  
Alimentação: 1 bateria 9V (incluída)  
Pinça de indução (incluída)  
2 ponteiros (incluídas)  
Estojo em tecido macio (incluído)  
Manual de instruções

1760DGT € 311,00 1 017600005

**1760DGT/2**

Multímetro digital automático, portátil, com função de osciloscópio de 2 canais e gerador de forma de onda

CE



199 mm

98 mm

**Inclui:**

- pontas de prova para multímetro
- 2 pinças crocodilo BNC para osciloscópio
- pontas de prova para osciloscópio (1X e 10X)
- carregador de bateria
- bolsa de nylon

**DADOS TÉCNICOS:**

Ecrã: 2.8" cor TFT  
Resolução: 320 x 240 pixels  
Corrente: 100V-240V AC, 50Hz-60Hz; DC INPUT 5V DC-2A  
Bateria: 2 x 2600 mAh

**ESPECIFICAÇÕES DO MULTÍMETRO**

Teste: Voltagem, Corrente, Resistência, Capacidade, Diodos e On-Off  
Voltagem Máxima: 600V AC-DC  
Corrente Máxima: 10AAC-DC  
Resistência Máxima: 40MOHM  
Capacidade Máxima: 100uF

**ESPECIFICAÇÕES DO OSCILOSCÓPIO**

Horizontal  
Largura de banda: 40MHz  
Amplitude da amostragem de sinal: 250MSa/s (canal único) - 125MSa/s (canal duplo)  
Amplitude SEC/DIV : 5ns/div ÷ 500s/div 1,2,5 sequência vertical  
Vertical  
Amplitude VOLTS/DIV: 10mV/div÷10V/divat BNC input  
Seleção analógica, limite de largura de banda, típico: 20MHz  
Resposta baixa frequência (-3db): ≤10Hz a BNC  
Precisão de ganho DC: ± 3% para modo de aquisição Normal ou Médio, 10V/div ÷ 10 mV/div  
Disparo  
Tipo de disparo: Borda  
Modo: Auto, Normal, Individual  
Inclinação: Subida, Descida, Subida & Descida  
Entrada de sinal: CH1, CH2  
Entrada  
Acoplamento: DC, AC ou GND  
Fator de atenuação da ponta de prova: 1X, 10X, 100X, 1000X  
Gerador arbitrário de formato de onda  
Frequência de formato de onda: Senoidal (1Hz÷25MHz), Quadrada (1Hz÷10MHz), Rampa (1Hz÷MHz), EXP (1Hz÷5MHz)  
Largura: 2.5Vpp (50Ω) - 5Vpp (alta impedância)  
Impedância de saída: 50Ω

Dimensões: 199 x 98 x 40 mm  
Peso: 624g

1760DGT/2 € 870,00 1 017600008

**1760B**  
multímetro digital

CE



**ESPECIFICAÇÕES**

Voltagem DC: 200 mV-2/20/200/1000V  
Voltagem AC: 2-20/200/700V  
Corrente DC: 2/20/200 mA-20 A  
Corrente AC: 2/200 mA- 20 A  
Resistência: 200Ω - 2/20/200 kΩ - 2/20 MΩ  
Capacidade: 2/20/200 nF - 2/200 μF  
Temperatura: -20° + 1000°C/ -4 °F ~ +2000°F  
Frequência: 20kHz  
Potência de alimentação: Pilha 1 9V (incluída)

1760B € 201,00 1 017600012

**17600HM/2**

megômetro para teste de isolamento de alta tensão

**Especificações:**

- Teste de isolamento até 100 GΩ com tensão de 1000V
- Visor de grandes dimensões, retroiluminado
- Proteção contra a água: IP67
- Base de terminais em borracha para maior conforto de utilização
- Terminais com duplo isolamento CAT IV 600V, CAT III 1000V
- Ideal para automóveis elétricos e híbridos

CE

CAT. III  
600V



**Especificações técnicas:**

Amplitude de medição  
Precisão  
Voltagem AC/DC: 10V - 600V ±(1.5% +5)  
Voltagem DC: 0V - ±600V ±(1.5% +5)  
Resistência: 0.01Ω - 200Ω ±(2% +5)  
Teste de isolamento @1000V: 0.01 - 100GΩ ±(1.5% +5)  
Frequência: 1~1KHz ±(0.1% +3)

17600HM/2 L 195 mm P 94 mm H 54 mm € 426,00 1 017600027



## 1760/RMS

multímetro digital industrial

EN61010-1  
EN61326-1



CE

Tipo de leitura	Precisão
Voltagem AC/DC	110mV - 600V ±0.8% - ±2% rdg
Corrente AC/DC	110µA - 10A ±1.5% - ±2% rdg
Resistência	110Ω - 40MΩ ±1.2% - ±2.5% rdg
Capacitância	11nF - 40mF ±5% - ±10% rdg (até 11mF)
Frequência rdg	1100Hz - 110 MHz ±1.2% - ±1.5%
Temperatura	-32°C - +1000°C ±3% - ±5% rdg
Teste de diodo, 3V DC	±10% rdg
Teste de continuidade	<30 Ω -

1760/RMS	€	259,00	1	017600020
----------	---	--------	---	-----------

## 1760S

multímetro digital compacto

Leitura TRUE RMS (valor efetivo)



CE

Parâmetros mensuráveis:  
 Voltagem DC: 200 mV-2/20/200/600V  
 Voltagem AC: 100/600V  
 Corrente DC: 200 mA-10 A  
 Corrente AC: 0,01-10 A  
 Resistência: 200Ω - 2/20/200 kΩ - 2 MΩ  
 Teste diodo: 0.4 + 0.7  
 Fonte alimentação: 2 pilhas 1.5V, tipo AAA

1760S	€	99,50	1	017600022
-------	---	-------	---	-----------

153x75x42 mm

## 1760PA/80

pinça amperimétrica AC/DC, 80A

Para medir fugas de baixa corrente  
ou valores de absorção em veículos



CE

- Alcance: 1mA-80A AC/DC
- Função lanterna com LED branco
- Visor LCD com retro-iluminação
- Função de reposição a zero
- Função de memorização
- Desliga-se automaticamente
- Alimentação: 2 pilhas 1.5V AAA

1760PA/80	€	259,00	1	017600002
-----------	---	--------	---	-----------

## 1760PA/AC

pinça amperimétrica e multímetro digital

A: AC  
V: AC/DC

CE



**ESPECIFICAÇÕES**  
 Voltagem DC: 400 mV - 4/40/400/600 V  
 Voltagem CA: 400 mV - 4/40/400/600 V  
 Corrente CA: 40/400/1000 A  
 Resistência: 400Ω - 4/40/400 kΩ - 4/40 MΩ  
 Frequência: 5/50/500 Hz - 5/50/500 kHz - 5/10 MHz  
 Capacidade: 40/400 nF - 4/40/100 µF  
 Temperatura: -20 °C ± 1000 °C / -4 °F ± 1832 °F  
 Alimentação: 1 bateria de 9V (incluída)

1760PA/AC	€	212,00	1	017600050
-----------	---	--------	---	-----------

## 1760PA/AC-DC

pinça amperimétrica e multímetro

A: AC/DC  
V: AC/DC

CE



A: AC/DC  
V: AC/DC

**ESPECIFICAÇÕES**  
 Voltagem DC: 0.1mV ÷ 600V  
 Voltagem AC: 0.1mV ÷ 600V  
 Corrente AC: 0.01A ÷ 1000A  
 Corrente DC: 0.01A ÷ 1000A  
 Resistência: 0.1Ω ÷ 40MΩ  
 Capacidade: 0.001nF ÷ 40 µF  
 Frequência: 0.001kHz ÷ 4kHz  
 Temperatura: -40°C ÷ 1000 °C  
 -40°F ÷ 1832°F

1760PA/AC-DC	€	384,00	1	017600000
--------------	---	--------	---	-----------

## 1760PA/AC-DC2000

grampo amperômetro com multímetro digital e  
ligação Bluetooth

Função TRUE RMS na gama AC

A: AC/DC  
V: AC/DC

CE



Parâmetros mensuráveis:  
 • Voltagem DC: 0.1mV ÷ 1000V  
 • Voltagem AC: 0.1mV ÷ 1000V  
 • Corrente AC: 0.01A ÷ 2000A  
 • Corrente DC: 0.01A ÷ 2000A  
 • Resistência: 0.1Ω ÷ 60MΩ  
 • Capacidade: 1nF ÷ 6000 µF  
 • Frequência: 10kHz ÷ 20kHz  
 • Temperatura: -20 °C ÷ 1000 °C -4 °F ÷ 1832 °F  
 • Potência de alimentação: 3 pilhas 1.5V, tipo AA (incluídas)  
 • Ligação Bluetooth (versão 4.0)

H mm	L mm	P mm	€	1	017600003
300	110	43	760,00	1	017600003

380x280x100 mm - 1,78 kg

## 1760DGT-R3

Cabos de substituição para multimetros digitais e braçadeiras amperométricas



1760DGT-R3 € 27,00 1 017600603

## 1760/RSE

Detetor de sinal

Permite testar a alimentação de componentes como: electro-injetores common rail, eletro-injetores gasolina/ GPL, injetores piezoelétricos, válvulas solenoides de regulação de fluxo / válvulas egr, bobinas, etc...



Permite fazer o diagnóstico de componentes elétricos através de uma sonda.

Em sistemas com componentes eletromecânicos / eletrônicos com uma unidade de controlo esta ferramenta permite verificar se:

- A unidade de controlo está a ser alimentada e se está a funcionar corretamente
- Os cabos de ligação estão intatos
- O componente não foi desligado
- O componente não entrou em curto circuito
- O componente está a funcionar eletronicamente

1760/RSE € 540,00 1 017600170



# Beta



## 1760/TC2

tacómetro digital combinado



### DADOS TÉCNICOS

- Para medições de:
  - rotações (rpm) à distância
  - rotações (rpm) por contacto e velocidade linear (m/min ou ft/min)
- Visor LCD de 5-dígitos
- Escala:
  - rotação à distância 2.5÷99,999 rpm
  - rotação por contacto 0.5÷19,999 rpm
  - velocidade linear 0.05÷1,999.9 m/min
- Frequência: 0.8 seg
- Alimentação: 4 pilhas 1.5V, tamanho AA, ou unidade de alimentação de 6V (não incluída)
- Fornecido com:
  - adaptador para medir por contacto;
  - ponteira macho (contacto) em borracha (2 peças);
  - ponteira fêmea (contacto) em borracha (1 peça);
  - fita medição linear (1 peça);
  - etiquetas reflectoras;
  - manual de instruções;
  - caixa plástica

1760/TC2 L 230 mm H 74 mm € 269,00 1 017600161

## 1760R/TC2

jogo de etiquetas reflectoras para artigo 1760/TC2



1760R/TC2 € 23,80 1 017600561

## 1760K

detetor de voltagem AC sem contacto, com mini-tocha LED

Intervalo de teste: 200-1000Vac 50/60Hz  
CAT III-1000V  
Utiliza 2 pilhas AAA (incluídas)



1760K € 43,00 1 017600140

## 1760PT/N

ferramenta de teste de voltagem e continuidade, 1000 V

Função de autoteste: a ferramenta não necessita de uma voltagem conhecida elevada para a calibragem



### Caraterísticas:

- Voltagem: 24÷1000VAC / 6÷1000VDC
- Indicador de Voltagem: 6-12-24-50-120-230-400-690-1000
- Precisão: ± (3% + 3)V
- Tempo de resposta: < 1s (09%)
- Corrente máxima absorvida @1000V: < 3,5mA
- Detecção de Voltagem sem contacto: > 90VAC
- Ensaio de rotação de fases:100÷1000VAC (50/60Hz)
- Ângulo de fase: 120° ±5°
- Teste de continuidade:0±1.3 MΩ
- Corrente (teste de continuidade): ≤5 µA
- Nível de poluição:
- Potência:

1760PT/N H 250 mm L 70 mm P 30 mm L1 850 mm € 131,00 1 017600155

## 1760/IR500

termómetro digital de infravermelhos com sistema de direcionamento laser duplo

não é adequado para medir a temperatura corporal



### Caraterísticas Técnicas

- Temperatura: -50 ÷ 500 °C (-22 ÷ +932 °F)
- Resolução: 0,1 °C (0,1 °F)
- Emissividade: 0.1 ÷ 1 ajustável
- Precisão: -50 °C ÷ +20 °C (+/- 3 °C); 20 ÷ 500 °C (+/-2% or 2 °C)
- Resolução: (D:S): 12:1
- Desliga automaticamente: a cada 10 segundos
- Temperatura de funcionamento: 0 °C ÷ 50 °C
- Temperatura de armazenamento: -20 °C ÷ 60 °C
- Alimentação: 1 9V bateria

1760/IR500 € 185,00 1 017600350



## 1760/IR1000

termómetro digital de infravermelhos com sistema de direcionamento laser duplo

não é adequado para medir a temperatura corporal



CE

### Caraterísticas Técnicas

Temperatura:  $-50\text{ }^{\circ}\text{C} + 1000\text{ }^{\circ}\text{C}$  ( $-58\text{ }^{\circ}\text{F} + 1832\text{ }^{\circ}\text{F}$ )  
Resolução do visor:  $0.1\text{ }^{\circ}\text{C}$  ( $0.1\text{ }^{\circ}\text{F}$ )  
Emissividade:  $0.1 + 1$  ajustável  
Precisão:  $-50\text{ }^{\circ}\text{C} + 20\text{ }^{\circ}\text{C}$  ( $\pm 3.5\text{ }^{\circ}\text{C}$ );  $20\text{ }^{\circ}\text{C} + 300\text{ }^{\circ}\text{C}$  ( $\pm 1\%$  or  $1\text{ }^{\circ}\text{C}$ );  $300\text{ }^{\circ}\text{C} + 1000\text{ }^{\circ}\text{C}$  ( $\pm 1.5\%$ )  
Resolução: (D:S): 20:1  
Temperatura de funcionamento:  $0\text{ }^{\circ}\text{C} + 50\text{ }^{\circ}\text{C}$   
Temperatura de armazenamento:  $-10\text{ }^{\circ}\text{C} + 60\text{ }^{\circ}\text{C}$   
Alimentação: 2 1.5V (baterias tipo AAA)

1760/IR1000 € 306,00 1 017600400

## 1760/IR1600

termómetro digital de infravermelhos com sistema de apontamento laser

não é adequado para medir a temperatura corporal



CE

### Dados técnicos

Capacidade de medição:  $-50\text{ }^{\circ}\text{C} + 1600\text{ }^{\circ}\text{C}$  /  $-58\text{ }^{\circ}\text{F}$  to  $+2912\text{ }^{\circ}\text{F}$   
Seleção escala:  $^{\circ}\text{C}/^{\circ}\text{F}$   
Precisão:  $\pm 1.5\%$  or  $\pm 2\text{ }^{\circ}\text{C}$  a  $20\text{ }^{\circ}\text{C}$   
Potência do laser:  $<1\text{mW}$   
Tempo de resposta: 1sec  
Emissividade: 0.10-1.0 ajustável  
Relação distância: (D:S) 50:1  
Temperatura de operação:  $0\text{ }^{\circ}\text{C} + 50\text{ }^{\circ}\text{C}$  /  $32\text{ }^{\circ}\text{F} + 122\text{ }^{\circ}\text{F}$   
Humidade de operação: 10% a 90% RH  
Visor LCD em Backlit  
Função de armazenamento  
Auto-desligar  
Alimentação: 1,9V pilha (incluída)  
Estojo em alumínio  
Manual de instruções

1760/IR1600 mm mm € 855,00 1 017600461

## 1760LX

luxímetro digital portátil

EN61010-1  
EN61326-1



CE

### Característica técnicas:

Intervalo de medição Precisão básica  
medição Lux:  $0-200000\text{ } \pm 3\%$   
medição FC:  $0-20000\text{ } \pm 3\%$   
Fonte alimentação: 1 x 9V

1760LX L mm € 117,00 1 017600820

## 1760TMC

Câmara termográfica de infravermelhos

Câmara termográfica compacta para medição da temperatura sem contacto, adequada para aplicações nas indústrias de construção, mecânica, instalação eléctrica e aquecimento.

ecrã LCD TFT, 2", 240x320  
detetor, 32x32 pixels  
velocidade sequencial 7Hz  
sensibilidade térmica  $<347\text{mK}$   
deteção automática de pontos quentes e pontos frios  
registo de imagens em formato BMP (max. 100 imagens)  
emissividade ajustável  
alimentação: 3 pilhas AAA alcalinas  
interface USB  
IP54  
amplitude de medição:  $-20\text{ }^{\circ}\text{C} + 600\text{ }^{\circ}\text{C}$   
banda espectral de infravermelhos:  $6.5 + 14\mu\text{m}$   
fusão de imagem visível/infravermelhos: 0.5; 1; 2m  
opção de alarme, em função das temperaturas máxima e mínima definidas



CE

1760TMC 600 € 980,00 1 017600710

## 1760WM

anemómetro digital com sensor de ventoinha

EN61010-1  
EN61326-1



CE

### Característica técnicas:

Intervalo de medição Precisão básica  
velocidade do ar m/s:  $0.4-30\text{ } \pm 2\%$   
velocidade do ar k/h:  $1.4-108\text{ } \pm 2\%$   
velocidade do ar ft/m:  $80-5900\text{ } \pm 2\%$   
velocidade do ar mil/h:  $0.8-58\text{ } \pm 2\%$   
fluxo de ar CFM:  $0.99990\text{ } \pm 0.9.999\text{ ft}^2$   
fluxo de ar CMM:  $0.99990\text{ } \pm 0.9.999\text{ m}^2$   
fluxo de ar CMS:  $0.99990\text{ } \pm 0.9.999\text{ m}^2$

1760WM L mm € 94,50 1 017600800

## 1761

alicate force-arame com retorno automático



1761 L mm € 76,00 1 017610101

## 1761RS/1

alicate force-arame reversível com retorno automático



1761RS/1 L mm € 136,00 1 017610130



**1762**  
alicate vazador



Ø mm	L mm	€		
2-2,5-3	210	35,50	2	017620001
3,5-4-4,5				

**1763**  
Alicate para agrafos de estofos auto



1763	€		
	41,50	1	017630001

**1763G/S500**  
500 agrafos para estofos auto



1763G/S500	€		
	78,00	1	017630105

**1764/K5**  
rebitadora manual para rebites em plástico

fornecida com rebites de 4 tamanhos

- kit contém:
- 10 rebites Ø 5x17.2 mm
  - 10 rebites Ø 5x15.8 mm
  - 10 rebites Ø 6.3x25.2 mm
  - 10 rebites Ø 6.6x17.2 mm



1764/K5	€		
	60,50	1	017640001

**1764/K5-R**  
pack de 20 rebites em plástico para artigo 1764/K5



	mm	€		
1764/K5-R1	5X17,2	16,60	1	017640003
1764/K5-R2	5X15,8	16,60	1	017640004
1764/K5-R3	6,3X25,2	16,60	1	017640005
1764/K5-R4	6,6X17,2	16,60	1	017640006

**1766**  
ventosa dupla



í max	€		
kg	141,00	2	017660001
50			

**1766A**  
ventosa simples



í max	€		
kg	36,00	2	017660005
30			



**1766/8**  
jogo de 8 ferramentas para vidros de viaturas



1766/8	€		
	525,00	1	017660100

**1766ER**  
ferramenta remoção de frisos das portas, com pega

Fácil remoção de frisos, sem risco de quebras



1766ER	€		
	25,50	1	017660501

**1766ER/VW**  
ferramenta remoção de frisos de janelas de baixo perfil particularmente adequada para frisos de janelas do grupo VAG com reduzido espaço de aderência

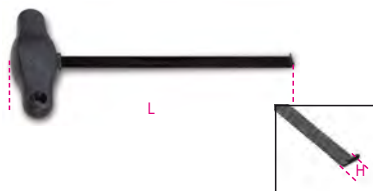

L	H	€		
mm	mm	18,10	1	017660510
215	4			

## 1766I

punhos para cabo de aço para vidros refª. 1766G



1766I € 57,50 2 017660020

## 1766G

cabo de aço para vidros

Secção quadrada



50 m € 51,00 1 017660025

## 1766T

cabo de aço para janelas de vidro

secção triangular



50 m € 59,00 1 017660026

## 1767A

Apoio telescópico

- Projetado para suportar o capô e tampas de mala com pistons descompactados.  
- Pode ser utilizada para impedir que os pedais se movimentem.



L mm € 80,00 1 017670000

## 1767B

kit bloqueio de pedal e volante de direção

o mecanismo de ajuste do gatilho garante regulações precisas com o veículo em aceleração



1767B € 171,00 1 017670100

490x285x95 mm - 2,4 kg

## 1767PMC

suporte de ferramentas magnético, redondo



1767PMC € 25,00 1 017670020

## 1767PMR

suporte de ferramentas magnético, rectangular



1767PMR € 51,00 1 017670010

## 1768

plataforma em alumínio

superfície revestida com material antiderrapante capacidade máxima de carga: 200 kg



L mm 960 L1 mm 300 H mm 475 € 220,00 1 017680010

## 1770

x-acto plano fornecido com 2 lâminas de substituição



1770 L mm 140 A mm 9 € 18,10 10 017700001

## 1770A

x-acto 9 mm com bloqueio automático lâmina 3 lâminas de substituição



1770A L mm 135 A mm 9 € 6,80 10 017700025

## 1770RL

10 lâminas divisível de 9 mm para refª. 1770,1770BM e 1770F



1770RL € 6,00 5 017700010

## 1771

x-acto, 18 mm, fornecido com 3 lâminas



1771 € 10,30 10 017710000





## 1771BM

x-acto com 6 lâminas de substituição bi-material



1771BM	L mm	A mm	€	🔧	📦
	170	18	22,50	10	017710050

## 1771HD

x-acto, 18 mm, fornecido com 6 lâminas  
• substituição automática da lâmina  
• sistema de bloqueio da lâmina



1771HD	L mm	A mm	€	🔧	📦
	190	18	25,50	5	017710100

## 1771RL

10 lâminas divisível de 18 mm para x-acto ref<sup>ª</sup>. 1771, 1771BM, 1771HD



1771RL	€	🔧	📦
	8,70	5	017710010

## 1772M

x-acto de segurança com lâmina retrátil, fornecido com 4 lâminas

- Lâmina retrátil através de mecanismo de mola automático
- Corpo em liga de alumínio fundido
- Removedor de agrafes integrado no punho



1772M	L mm	A mm	€	🔧	📦
	170	18	20,50	5	017720040

## 1772R

x-acto com lâmina trapezoidal retrátil, fornecido com 5 lâminas



1772R	L mm	A mm	€	🔧	📦
	125	18	19,00	5	017720006

## 1772H

x-acto de lâmina retrátil, de segurança, lâmina de substituição



1772H	L mm	A mm	€	🔧	📦
	170	18	20,00	5	017720029

## 1772RL/2

10 lâminas trapezoidais de substituição longas, em caixa, para x-actos, 1772H, 1772M, 1772R, 1774, 1777BMT, 1777T

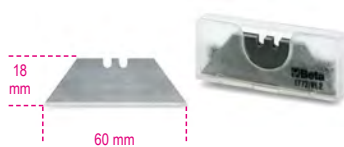

1772RL/2	€	🔧	📦
	4,80	5	017720017

## 1773A

x-acto



1773A	L mm	A mm	€	🔧	📦
	180	25	20,00	10	017730000

## 1773RL

10 lâminas divisível de 25 mm para x-acto ref<sup>ª</sup>. 1773



1773RL	€	🔧	📦
	19,60	5	017730015

## 1773S

x-acto com lâmina redonda

- lâmina principal Ø 28 mm
- lâmina secundária para cortar filme
- gancho para pendurar



1773S	L mm	A mm	€	🔧	📦
	190	28	9,40	1	017730100

## 1773S/RL

3 lâminas redondas, Ø 28 mm para x-acto 1773S



1773S/RL	€	🔧	📦
	4,15	5	017730110

## 1773U

ferramenta multiusos para silicone

- Inclui:
- 5 pontas angulares em borracha
- lâmina raspadora de substituição



1773U	L mm	€	🔧	📦
min 190 - max 215		27,50	1	017730500

## 1773U/R

kit de substituição para ferramenta multiusos para silicone 1773U

- 5 pontas angulares em borracha
- lâmina raspadora de substituição

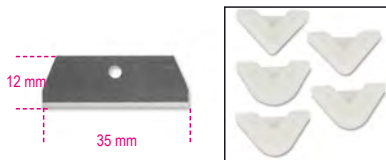

1773U/R	€	🔧	📦
	10,40	2	017730510

## 1774

raspador com resguardo de protecção



1774	L mm	L1 mm	€	🔧	📦
	155	60	4,90	5	017740001

## 1774A

raspador multifuncional, com punho bi-material



1774A	L mm	A mm	€	🔧	📦
	300	40	15,30	1	017740011

## 1774A/RL

10 lâminas para raspador multi-funções 1774A

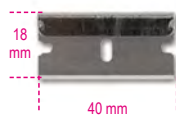

1774A/RL	€ 7,30	1	017740511
----------	--------	---	-----------

## 1774S

raspador para remoção de autocolantes



1774S	A mm	L mm	€ 8,30	2	017740021
-------	------	------	--------	---	-----------

## 1777BM

navalha com lâmina em aço inoxidável e entalhe para descarnar



1777BM	L mm	L1 mm	A mm	€ 13,10	5	017770100
--------	------	-------	------	---------	---	-----------

## 1777T

navalha com lâmina trapezoidal em aço, com 5 lâminas de substituição



1777T	L mm	A mm	L1 mm	€ 28,50	5	017770030
-------	------	------	-------	---------	---	-----------

## 1777BMT

canivete com lâmina trapezoidal rebatível 4 posições ajustáveis da lâmina 4; 9.5; 15.5; 21.5 mm fornecido com 3 lâminas



1777BMT	L mm	L1 mm	A mm	€ 30,50	5	017770050
---------	------	-------	------	---------	---	-----------

## 1778AN

canivete, lâmina em aço inox, punho leve em alumínio anodizado  
• em estojo



1778AN	L mm	A mm	L1 mm	€ 35,00	5	017780065
--------	------	------	-------	---------	---	-----------

## 1778AX

canivete, lâmina em aço de inox serrilhada, pega em alumínio, serration pattern for easier opening  
• em estojo



1778AX	L mm	A mm	L1 mm	€ 38,50	5	017780026
--------	------	------	-------	---------	---	-----------

## 1778BS

canivete com duplo bloqueio de segurança, lâmina serrilhada em aço inox, acabamento em carbono  
• em bolsa



1778BS	L mm	A mm	L1 mm	€ 38,50	10	017780035
--------	------	------	-------	---------	----	-----------

## 1778CM

canivete camuflado, lâmina em aço reforçado, fornecido em estojo



1778CM	L mm	A mm	L1 mm	€ 36,00	5	017780099
--------	------	------	-------	---------	---	-----------

## 1778M7

canivete, mini lâmina em aço inox, punho com inserts em fibra de vidro  
• em estojo



1778M7	L mm	A mm	L1 mm	€ 31,00	5	017780015
--------	------	------	-------	---------	---	-----------

## 1778P

canivete, lâmina e punho em aço inox e alumínio, mecanismo de bloqueio de abertura  
• em estojo



1778P	L mm	A mm	L1 mm	€ 41,50	5	017780088
-------	------	------	-------	---------	---	-----------

## 1778SCL

canivete acabamento macio, lâmina em aço reforçado, fornecido em estojo



1778SCL	L mm	A mm	L1 mm	€ 34,00	5	017780089
---------	------	------	-------	---------	---	-----------

## 1778SOS

navalha manutenção automóvel com quebra-janelas e cortante para cintos de segurança fornecida em bolsa



1778SOS	L mm	A mm	L1 mm	€ 36,00	5	017780080
---------	------	------	-------	---------	---	-----------

## 1778V18

canivete,  
punho em alumínio  
• fornecido em bolsa



	L mm	A mm	L1 mm	€	🔧	📦
1778V18	195	25	85	34,00	5	017780018

## 1778X

navalhas para manutenção náutica, lâminas em aço inoxidável, punhos em alumínio



	L mm	L1 mm	S mm	€	🔧	📦
1778X	185	85	25	33,00	2	017780050

## 1778MT - MULTITOOL

A ferramenta multiusos da BETA destaca-se de ferramentas semelhantes disponíveis no mercado, com características típicas BETA: alicate sinónimo de qualidade inigualável, materiais sofisticados e tecnologia de ponta. Os 11 bits para parafusos, nas geometrias mais populares do mercado, tornam este artigo ideal para qualquer ambiente e condições de trabalho, por exemplo, no campismo, na indústria náutica, na caça ou bricolage.

**22 FUNÇÕES**

**PRO WILD MULTITOOL**

11 bits + chave de caixa

Régua 100 mm / 4"

## 1778MT

multi-tools  
com bits e bolsa  
9 ferramentas  
22 funções



	L mm	L1 mm	€	🔧	📦
1778MT	180	115	109,00	1	017780055

## 1781

tesoura com lâminas longas e finas



	L mm	€	🔧	📦
1781	132	20,10	2	017810001

## 1783

tesoura de serviços ligeiros



	L mm	€	🔧	📦
1783	215	16,70	5	017830021
	240	18,70	5	017830024

# Beta



**1784**

tesouras série pesada



L mm	€	Unid.	018000000
175	23,90	2	017840017
200	32,00	2	017840020
250	42,50	2	017840025
300	57,50	2	017840030

**1800/100**

almofada insuflável (cap. máx. elevação: 100 kg)

- elevação/nivelação
- abertura de portas em caso de emergência



A mm	B mm	S mm	€	Unid.	018000000
160	150	2÷55	68,50	3	018000000



## ILUMINAÇÃO

A gama de iluminação inclui uma vasta gama de produtos concebida para satisfazer os requisitos de todos os utilizadores, desde a inspeção de pequenos tubos à iluminação de áreas de trabalhos de grandes dimensões.

### LANTERNAS

O novo e atraente design, as melhorias técnicas e a ampla escolha de tamanhos permitem a seleção da lanterna mais adequada, tomando como base critérios como brilho, duração da bateria e desempenho.



### LÂMPADAS E FOCOS

Grças à tecnologia LED melhorada, à maior vida útil das baterias, a menor tempo de carga, à atenção meticulosa aos materiais e à pesquisa contínua de soluções inovadoras, as luzes de trabalho Beta são uma combinação notável de design, funcionalidade e performance. Uma gama abrangente concebida para garantir aos profissionais um trabalho nas melhores condições, em qualquer setor e sob quaisquer condições.



### WIRELESS

A gama de equipamentos de iluminação sem fio da Beta inclui lanternas, lâmpadas, lanternas de cabeça e holofotes LED, que podem ser facilmente carregados através de uma base de carga. Desta forma, os cabos, que podem ser problemáticos durante o trabalho, já não são necessários.

A tecnologia sem fio é uma das mais recentes inovações na indústria da iluminação de trabalho. Este sistema inovador oferece uma solução prática e moderna, indo assim ao encontro das necessidades de cada profissional.

A base sem fio com duas posições de carga pode ser pendurada na parede, para que tenha sempre ao seu alcance os equipamentos de iluminação necessários para o seu trabalho com uma organização simplificada do espaço.

Além disso, o suporte extraível permite carregar o seu telemóvel.

### CRI - Color Rendering Index

### CCT - Correlated Color Temperature

HOLOFOTES							
ITEM	LUMEN	BATERIA	TEMPO DE CARGA	VIDA ÚTIL	IP/IK	CCT	CRI
1837C/2100	500 - 1000 - 2100	Li-Ion 11.1V; 4400 mAh	4.0h	9 - 2.5h	IP65 - IK07	6500K	80+
1837C/4300	1100 - 2100 - 4300	Li-Ion 11.1V; 5200 mAh	4.0h	6 - 1.5h	IP65 - IK07	6500K	80+
1838FLASH	360 - 720	Li-Ion 7.4 V; 4000 mAh	4.0h	4 - 8h	IP65	6300K	-
1838POCKET	160 - 400 - 800	Li-Ion 3.7 V; 2600 mAh	4.0h	3 - 9h	IP65	6500K	80+

LANTERNAS							
ITEM	LUMEN	BATERIA	TEMPO DE CARGA	VIDA ÚTIL	IP/IK	CCT	CRI
1838/11LED	320	Li-Ion 3.7V; 4200 mAh	4.0h	4h	IP65	6500K	
1838AM	60 - 700 120 (spot)	Li-Ion 3.7V; 2600 mAh	4.0h - USB-C	2.5 - 16h 10h (spot)	IP54 - IK07	6500K	80+ 70+
1838COMPACT	120 - 150 - 300	Li-Ion 3.7V; 1500 mAh	2.5h	7 - 6 - 3.5h	IP65 - IK07	6500K	80+
1838PN	120 - 175 - 350	Li-Ion 3.7V; 1600 mAh	3h	6 - 3h	IP65 - IK07	6000 - 6500K	80+
1838SLIM	100 - 200 180 (back) 80 (spot)	Li-Ion 3.7 V; 700 mAh	2.5h - USB-C	2 - 4h 2h (back) 3h (spot)	IP54 - IK07	6500K	80
1838SW	250 - 500 - 1000	Li-Ion 3.6V; 3350 mAh	4.5 - 6.5h	3 - 7h	IP65 - IK07	6500K	80+
1838E	500 - 1000 - 2000	Li-Ion 3.6V; 3350 mAh	4.5 - 6.5h	3 - 9h	IP20 - IK07	5500K	80+

LANTERNAS DE CABEÇA							
ITEM	LUMEN	BATERIA	TEMPO DE CARGA	VIDA ÚTIL	IP/IK	CCT	CRI
1836B	125 - 250	Li-Ion 3.8V; 1600 mAh	3.0h	5h	IP65 - IK07	6000K	80+
1836AW	30 - 200 - 400	Li-Ion 3.7V; 1500 mAh	2.5h	4-18h	IP65 - IK07	6500K	80+

LUZES DE TRABALHO						
ITEM	LUMEN	BATERIA	TEMPO DE CARGA	VIDA ÚTIL	IP/IK	ALCANCE
1833XS/1	100	1 x AAA	-	5h	IP66	85m
1833XS/2	200	2 x AAA	-	10h	IP66	112m
1833S	500	2 x AA	-	10h	IP66	140m
1833M	700	3 x AAA	-	7.5h	IP66	170m
1833L	1100	3 x AA	-	8.5h	IP66	330m
1833XSW	80 - 250	Li-ion 3.7V 2600 mAh	2.0 h	2.0-8.0h	IP54 - IK07	50m
1833MW	5 - 30 - 400 - 1000	Li-ion 3.7V; 2600 mAh	4.0 - 6.0 h	2.0- 200.0h	IP68 - IK07	150m
1833XL	1500	3xD	-	22h	IP66	290m
1837F/USB	600	Li-Ion 3.7 V, 2900 mAh	4.0h - USB-C	10h	IP66	280m

## 1833XS/1

lanterna de inspeção LED,  
em alumínio anodizado robusto

- 100 lumens
- foco ajustável
- pilhas: 1xAAA (não incluídas)
- IP66
- autonomia: 5.0h
- alcance: 85 m



L mm 92 € 23,00 3 0183330000

## 1833XS/2

lanterna de inspeção LED,  
em alumínio anodizado robusto

- 200 lumens
- foco ajustável
- pilhas: 2xAAA (não incluídas)
- IP66
- autonomia: 10.0h
- alcance: 112 m



L mm 133 € 25,00 3 0183330001

## 1833XSW

lanterna de inspeção LED, recarregável sem fio

- 2 níveis de luminosidade: LED SMD, 250 - 80 Lúmen
- Bateria recarregável: 3.7V 700 mAh., 2.59 Wh Li-ion
- 2 modos de carga:  
base wireless 1839BRW  
fonte de alimentação com entrada USB-C
- Tempo de carga:  
2h com base wireless  
2h com fonte de alimentação
- Autonomia: 2-8h
- Indicador de nível da bateria LED
- Ímanes na base e atrás
- clipe para cinto
- IP54
- IK07
- Cabo USB-C incluído



L mm 145 € 54,00 1 0183330011

## 1833S

lanterna LED de elevada luminosidade,  
em alumínio anodizado robusto,  
até 500 lumens

- foco ajustável
- 2 níveis de luminosidade reguláveis
- pilhas: 2xAA (não incluídas)
- autonomia: 10.0h
- IP66
- alcance: 140 m



L mm 150 € 43,00 1 0183330002

## 1833M

lanterna LED de elevada luminosidade,  
em alumínio anodizado robusto,  
até 700 lumens

- foco ajustável
- 2 níveis de luminosidade reguláveis
- pilhas: 3xAAA (não incluídas)
- indicador bateria fraca (<15%)
- autonomia: 7.5h
- IP66
- alcance: 170 m



L mm 162 € 54,00 1 0183330003

## 1833MW

lanterna LED de elevada luminosidade,  
recarregável sem fio

- 4 níveis de luminosidade: LED SMD, 1000 - 400 - 30 - 5 Lúmen
- Bateria recarregável: 3.7V 2600 mAh, 9.62 Wh Li-ion
- 2 modos de carga:  
base wireless 1839BRE  
fonte de alimentação com entrada USB-C
- Tempo de carga:  
6h com base wireless  
4h com fonte de alimentação
- Autonomia: 2-200h
- Indicador de nível da bateria com 3 LEDs
- Íman atrás
- IP68
- IK07
- Cabo USB-C incluído



L mm 160 € 99,00 1 0183330013

## 1833L

lanterna LED de elevada luminosidade,  
em alumínio anodizado robusto,  
até 1,100 lumens

- foco ajustável
- 2 níveis de luminosidade reguláveis
- pilhas: 3xAA (não incluídas)
- indicador bateria fraca (<15%)
- autonomia: 8.5h
- IP66
- alcance: 330m



L mm 196 € 90,00 1 0183330004

## 1833XL

lanterna LED de elevada luminosidade,  
em alumínio anodizado robusto,  
até 1,500 lumens

- foco ajustável
- 2 níveis de luminosidade reguláveis
- pilhas: 3xD (não incluídas)
- indicador bateria fraca (<15%)
- autonomia: 22.0h
- IP66
- alcance: 290 m



L mm 300 € 113,00 1 0183330005

## 1836AW

lanterna de cabeça LED recarregável, dupla  
luminosidade

- emissão de luz dupla:  
frente: 3 intensidades de luz, LED COB, 30 - 200 - 400 lumens  
cabeça (foco): LED COB, 400 lumens
- bateria recarregável: Li-Ion 3,7 V, 1500 mAh, 5,55 Wh
- porta USB-C
- fornecida com cabo USB-C
- tempo de carga: 2,5 h
- duração da bateria:  
frente: 4-18 h  
cabeça (foco): 4 h
- IP 65
- IK 07



1836AW € 81,50 1 0183600051



## 1836B

lanterna de cabeça LED recarregável, dupla luminosidade, com sensor ON/OFF

- Sensor ON/OFF sem contacto
- equipada com cabos USB/minijack + carregador
- 250 lúmens
- Duração da bateria: 3-6 h
- IP65



1836B € 148,00 1 018360200

## 1837F/USB

lâmpada magnética articulada com LEDs de alta luminosidade, em alumínio anodizado robusto, até 600 lúmens

- foco ajustável
- 2 intensidades
- autonomia: 10.0h
- indicador de bateria fraca <15%
- entrada de carga USB-C
- com cabo USB-C
- IP66



L 460 € 145,00 1 018370060

## 1837RB-F/USB

bateria suplementar para referência 1837F/USB

1837RB-F/USB € 42,50 1 018370960



## 1838/11LED

lanterna de inspeção recarregável com LEDs de elevada luminosidade, bateria polímero de lítio

- Construção compacta em borracha antiderrapante
- Vidro frontal de fácil substituição
- Gancho para suspensão
- Com carregador, 110-230Vac
- 320 lúmens
- Com cabeça LED multi-posições



1838/11LED € 187,00 1 018380111

## 1838RA/10-11LED

fonte de alimentação para substituição para artigo 1838/10LED e 1838/11LED

1838RA/10-11LED € 39,50 1 018380903

## 1838RB/10LED

bateria para artigos 1838/10LED e 1838/11LED

1838RB/10LED € 63,00 1 018380902

## 1838RR/11LED

carregadores para artigo 1838/11LED

1838RR/11LED € 41,50 1 018380914

## 1838RV/11LED

vidro sobresselente anti-riscos para lanterna 1838/11LED

1838RV/11LED € 5,80 2 018380905

## 1838SW

lanterna LED de inspeção, recarregável, articulada, com carregador sem fios

- dupla emissão de luz:
- frontal: LED COB, 3 intensidades: 250 - 500 - 1000 lumens
- spot (cabeça): LED SMD, 200 lumens
- bateria 3.6V 3.350mAh Li-ion recarregável
- 2 modos de carga: base 1839BRW sem fios fonte alimentação via porta USB-C
- tempo de carga: 6.5h com base sem fios 4.5h com fonte de alimentação
- duração da bateria: frontal: 3-5h spot (cabeça): 7h
- Indicador nível de bateria de 3 LED
- base rotativa a 180°
- corpo em borracha antiderrapante
- gancho de suspensão duplo
- 3 ímanes na parte posterior
- 1 íman na base
- IP65
- IK07
- fornecida com cabo USB-C



1838SW L 260 mm I 53 mm S 40 mm € 110,00 1 018380142





## 1838AM

lanterna LED de inspeção recarregável, com emissão dupla de luz, articulada, rotação de 180°, com base magnética rotativa e gancho

- emissão dupla de luz: frente: LED COB, 60-700 lumens, pode ser ajustada com potenciômetro ponto (cabeça): LED SMD, 120 lumens, interruptor ON-OFF
- bateria recarregável 3.6V 2600mAh Li-ion
- com entrada USB-C
- fornecida com carregador 100-240V / 50-60Hz
- tempo de carga: 4h
- autonomia: frente: 2.5-16h ponto (cabeça): 10h
- indicador de nível da bateria 3 LEDs

- articulada, rotação 180° (± 90° em relação ao eixo)
- base magnética (com íman de neodímio), rotação 90°
- gancho rotativo na base

- IP54
- IK07



	L	I	S	L1		€		
	mm	mm	mm	mm				
1838AM	405	40	45	175		123,00	1	018380400

## 1838SLIM

lanterna de inspeção slim, 3-LED, articulada e recarregável

- emissão de luz tripla
- frente: 100/200 lúmens/ atrás: 180 lúmens/ foco (topo): 80 lúmens
- base magnética
- tempo de carga: 2.5h
- autonomia: 2-4h/ foco 3h
- com cabo USB-C

CE  
IP54

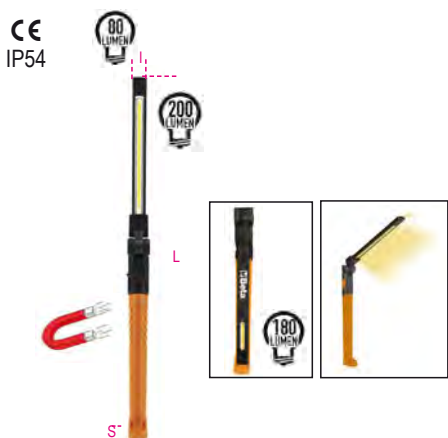

	L	I	S		€		
	mm	mm	mm				
1838SLIM	307	17	29		82,50	1	018380221

## 1838COMPACT

lanterna LED compacta, recarregável

- dupla emissão de luz: principal e foco
- 3 intensidades de iluminação: luz principal COB LED 300 - 120 lúmenes foco SMD LED 150 lúmenes
- bateria recarregável: Li-Ion 3.7 V, 1500 mAh
- tempo de carga: 2.5h
- duração da bateria: luz principal: 7/3.5h foco: 6h
- pode ser pendurada, com corpo em borracha antiderrapante e anti-impacto
- gancho rotativo 360°
- base magnética rotativa 180°
- clipe para cinto/bolso
- IP65
- IK07
- cabo USB-C incluído

CE



IP65  
IK07

	L		€		
	mm				
1838COMPACT	120		71,00	1	018380011

## 1838PN

lanterna LED tipo caneta recarregável

- dupla emissão de luz: principal e foco
- 3 intensidades de iluminação: luz principal COB LED 350 - 175 lúmenes foco: SMD LED 120 lúmenes
- bateria recarregável: Li-Ion 3.7 V, 1600 mAh
- tempo de carga: 2.5h
- duração da bateria: luz principal: 6/3h foco: 6h
- base magnética
- clipe para cinto/bolso
- IP65
- IK07
- cabo USB-C incluído

CE



IP65  
IK07

	L		€		
	mm				
1838PN	175		63,50	1	018380008

## 1838POCKET

luz de bolso articulada LED, com feixe duplo e carregamento sem fio

- emissão dupla: luz principal: LED COB, 3 intensidades: 160 - 400 - 800 lúmens foco: LED SMD, 250 lúmens
- ângulo de iluminação: luz principal: 160° foco: 18°
- bateria recarregável 3.7V 2600mAh Li-ion
- 2 modos de carga: base sem fio 1839BRW fonte alimentação via entrada USB-C
- tempo de carga: 4.5 h com base sem fio 4 h com fonte de alimentação
- duração da bateria: luz principal: 3-9h foco: 4.5 h
- indicador nível de bateria de 3 LED
- rotação a 210°
- corpo em borracha antiderrapante
- base magnética
- 1 íman na base
- IP65
- IK07
- com cabo USB-C

CE



IP65  
IK07

L	I	S		€		
mm	mm	mm				
98	82	39		77,00	1	018380080

## 1838FLASH

holofote recarregável ultracompacto, concebido para proporcionar a melhor solução possível para cada aplicação

LUMINOSIDADE ELEVADA: com uma capacidade máxima de iluminação de 720 lumens, com funcionamento a bateria ou cabo, está sempre pronto a utilizar.

UTILIZAÇÃO EM QUALQUER SUPERFÍCIE:

- em superfícies planas: com pés de borracha em 3 posições ou tripé standard 1/4" (similar ao das câmaras fotográficas)
- em estruturas metálicas: com íman ou gancho com rotação a 360 graus.

COMPACTO: com as dimensões 85x100x155 mm, pode ser facilmente transportado no saco de ferramentas e utilizado em espaços reduzidos.

ROBUSTO: concebido para resistir a esforços mecânicos extremos. Durabilidade garantida.

CE



IP65

	€		
1838FLASH	381,00	1	018380300

## 1838RB/FLASH

bateria para lanterna ref. 1838/FLASH

	€		
1838RB/FLASH	83,00	1	018380930

## 1837C

holofote LED recarregável para estaleiros de construção

- 3 níveis de luminosidade
- carregador de bateria: entrada: 100-240V AC - 50/60Hz; saída: 15V 1.5A
- tempo de carga: 4 horas
- indicador de carga com 3 LED
- com rotação 180°
- IP65
- IK07



IP65  
IK07

LxHxI mm	Lm	h	€		
220x225x70	2100	2.5	215,00	1	018370210
		5.0			
		9.0			
266x236.6x59	4300	1.5	316,00	1	018370430
		3.0			
		6.0			

## 1837C/RA2100-4300

	€		
1837C/RA2100-4300	30,50	1	018370970

## 1837S

tripé telescópico para holofote

- em metal
- altura ajustável: 70÷155 cm
- compatível com os itens 1837C e 1838FLASH



h cm	€		
70÷170	70,00	1	018370500

## 1838E

lâmpada de trabalho LED recarregável

- emissão de luminosidade tripla: 500/1000/2000 lumens
- rotativa a 360°
- alcance: 116 ÷ 188 cm
- corpo em alumínio
- ganchos em borracha antiderrapante
- Carregamento USB-C
- 2 modos de carga:  
via porta USB da lâmpada  
via porta da bateria USB interna
- fornecida com carregador de bateria  
entrada: 100-240V ~ 50/60Hz  
saída: DC 5V - 2000 mA
- autonomia: 3-9 h
- IP20
- IK07



IP20  
IK07

L min mm	L max mm	I mm	€		
1170	1880	150	209,00	1	018380270

## 1838E-BT

bateria recarregável com porta USB-C para lâmpada de trabalho 1838E

- Li-Ion 3,6V
- DC 5V - 2000 mA

CE

	€		
1838E-BT	59,00	1	018380271

## 1839BRW

base de carga sem fios, compatível com as luzes de trabalho 1838POCKET, 1838SW

- duas posições de carga com ligação magnética, para utilização em simultâneo
- com apoio sem fios para carregamento de telemóvel
- indicador LED do nível de carga
- potência entrada máx.: 10W x2
- potência de entrada: AC 100-240V 50/60Hz
- potência de saída: DC 12V 1.5A  
DC 9V 2A  
DC 5V 3A
- porta USB-C
- possibilidade de suspensão através de: 3 potentes ímanes no verso  
2 furos para parafusos

- IP20
- IK07



L	I	S	€		
mm	mm	mm			
1839BRW	101	290	28	104,00	1 018390002

## 1839/R5

cabo USB-C QC 3.0, de substituição para artigos 1838POCKET, 1839BRW

	€		
1839/R5	9,50	1	018390505

## 1839/R6

transformador de carga rápida USB Q C3.0, de substituição para 1838POCKET, 1839BRW

	€		
1839/R6	28,00	1	018390506

## 1839/R1

transformador de saída USB, para substituição dos artigos 1833L/USB, 1836B, 1837F/USB, 1838COB, 1838P, 1838S, 1838SLIM, 1838UV, 1838AM, 1838E, 1838COMPACT, 1838PN

CE

	€		
1839/R1	27,00	1	018390501

## 1839/R2

cabo USB/ 3.5 mm de substituição para artigos 1836B; 1838P; 1838COB; 1838UV

	€		
1839/R2	10,50	1	018390502

## 1839/R4

cabo USB/USB-C, acessório para as referências 1833L/USB, 1833F/USB, 1838SLIM, 1838S, 1838AM, 1838E, 1838COMPACT, 1838PN

	€		
1839/R4	9,30	1	018390504



## 1842LED/BM

Lanterna com LEDs de elevada luminosidade, 230 Vac

- cabo 10m comp.
- corpo compacto em borracha antiderrapante
- vidro frontal de substituição fácil
- gancho rotativo
- 340 lumens
- com cabeça LED direccionável

CE



IP65

1842LED/BM	L mm 230	€ 155,00	1	018420301
------------	-------------	-------------	---	-----------

## 1842LED/ABM

Lanterna com LEDs de elevada luminosidade, 24 V

- cabo 10m comp.
- corpo compacto em borracha antiderrapante
- vidro frontal de substituição fácil
- gancho rotativo
- 340 lumens
- com cabeça LED direccionável

CE



IP65

1842LED/ABM	L mm 230	€ 147,00	1	018420311
-------------	-------------	-------------	---	-----------

## ENROLADORES



A variada e abrangente gama de enroladores da Beta foi pensada e desenvolvida para satisfazer todas as necessidades dos profissionais.

- A gama de enroladores é adequada para vários comprimentos e tipos de cabos elétricos, versões com lâmpadas LED e com tomadas e fichas SCHUKO.
- A gama inclui enroladores para tubos de ar comprimido ou água de 8 mm e 10 mm de diâmetro.

Mola de elevada resistência garantindo durabilidade notável e suavidade incomparável. Tambores em polipropileno espesso, para resistência única ao impacto.

Dispositivo de cremalheira que faz com que o enrolamento automático do cabo pare, fácil de desativar, para permitir o enrolamento contínuo.

Cada enrolador está equipado com um suporte giratório 180° para montagem na parede e um suporte adicional para ligação rápida ao desligar do suporte de parede.

### ENROLADORES DE CABO

Uma ampla gama que inclui nada menos que 18 versões, concebidas para satisfazer quaisquer requisitos de trabalho, incluindo dos utilizadores mais exigentes. Comprimentos de 10 m a 30 m, e seções de 2x1,0 mm<sup>2</sup> a 5Gx1,5 mm<sup>2</sup>, com tipos de cabos H05VV-F e H07RN-F. Todos os enroladores de cabo - até uma seção de cabo de 3Gx2,5mm<sup>2</sup> - são fornecidos com interruptores de proteção térmica, que são acionados em caso de sobrecarga do circuito elétrico.



### ENROLADORES DE TUBO

Gama selecionada, com comprimentos de 10 m a 15 m, 8 mm, 10 mm e 12 mm de diâmetro, para utilização com ferramentas pneumáticas. Como os nossos produtos são à prova de fugas, eles também podem ser utilizados com água.

pag. 339

Item		Condutores	Secção	Tipo de cabo	Comprimento	Caixa	Interruptor proteção térmica	Accessory
1842 15-H05/LED	018420821	2x	1,0 mm <sup>2</sup>	H05VV-F	15+1 m	Pequena	NO	LED lamp
1843 15-H05	018430215	2x	1,5 mm <sup>2</sup>	H05VV-F	15+1 m	Pequena	YES	
1844 10-H05	018440310	3G	1,5 mm <sup>2</sup>	H05VV-F	10+1 m	Pequena	YES	-
1844 15-H05	018440315			H05VV-F	15+1 m	Pequena	YES	-
1844 15-H07	018440317			H07RN-F	14+1 m	Pequena	YES	-
1844 30-H05	018440330			H05VV-F	30+2 m	Média	YES	-
1844 15-H05/SCK	018440316	3G	1,5 mm <sup>2</sup>	H05VV-F	15+1 m	Pequena	YES	SCHUKO
1844 15-H07/SCK	018440318			H07RN-F	14+1 m	Pequena	YES	SCHUKO
1845 12-H05	018450365	3G	2,5 mm <sup>2</sup>	H05VV-F	12+1 m	Pequena	YES	
1845 15-H07	018450367			H07RN-F	15+1 m	Média	YES	
1845 25-H07	018450377			H07RN-F	25+1,5 m	Média	YES	
1846 10-H05	018460405	4G	1,5 mm <sup>2</sup>	H05VV-F	10+1 m	Pequena	NO	
1846 10-H07	018460407			H07RN-F	10+1 m	Pequena	NO	
1846 15-H05	018460415			H05VV-F	15+1 m	Pequena	NO	
1847 10-H05	018470420	4G	2,5 mm <sup>2</sup>	H05VV-F	10+1 m	Média	NO	
1847 15-H07	018470427			H07RN-F	15+1 m	Média	NO	
1848 10-H05	018480510	5G	1,5 mm <sup>2</sup>	H05VV-F	10+1 m	Média	NO	
1848 15-H07	018480517			H07RN-F	15+1 m	Média	NO	





## 1842

enrolador de cabo elétrico automático com lanterna LED, 100-240Vac

- com transformador de segurança 230/12V
- cabo H05VV-F 2x1.0 mm<sup>2</sup>
- comprimento do cabo enrolado: 15 m
- cabo de entrada 1,5 m com tomada tipo SCHUKO
- comprimento do cabo fora do tambor: 1 m
- mecanismo de cremalheira pode ser desativado para manter o cabo puxado
- fornecido com suporte giratório 180° e um suporte adicional de ligação rápida

CE

IP42  
IP65

L=15 m



Model	Cable	L (m)	€	Accessories	Code
1842 15-H05/LED	H05VV-F	15+1	385,00	1	018420821

## 1846R-LED/BM

lâmpadas LED

12-24V - AC-DC



1846LED/BM R			106,00	1	018460331
--------------	--	--	--------	---	-----------

## 1843

enrolador de cabo elétrico automático, com cabo 2x1.5 mm<sup>2</sup>

- cabo H05VV-F 2x1,5 mm<sup>2</sup>
- com interruptor de proteção térmica
- comprimento do cabo enrolado: 15 m
- comprimento do cabo fora do tambor: 1 m
- fornecido sem cabo de entrada
- mecanismo de cremalheira pode ser desativado para manter o cabo puxado
- potência máx. (cabo enrolado): 1300W (230V-20°C)
- potência máx. (cabo desenrolado): 2300W (230V-20°C)
- fornecido com suporte giratório 180° e um suporte adicional de ligação rápida

CE

IP42



1843 15-H05	H05VV-F	15+1	257,00	1	018430215
-------------	---------	------	--------	---	-----------

## 1844

enrolador de cabo elétrico automático, com cabo 3Gx1.5 mm<sup>2</sup>

- cabo 3Gx1.5 mm<sup>2</sup>
- com interruptor de proteção térmica
- comprimento do cabo fora do tambor: 1 m (exceto for 1844 30-H05, 2 m)
- fornecido sem cabo de entrada
- mecanismo de cremalheira pode ser desativado para manter o cabo puxado
- potência máx. (cabo enrolado): 1500W (230V-20°C)
- potência máx. (cabo desenrolado): 2500W (230V-20°C)
- fornecido com suporte giratório 180° e um suporte adicional de ligação rápida

CE

IP42



Model	Cable	L (m)	€	Accessories	Code
1844 10-H05	H05VV-F	10+1	229,00	1	018440310
1844 15-H05	H05VV-F	15+1	251,00	1	018440315
1844 15-H07	H07RN-F	14+1	273,00	1	018440317
1844 30-H05	H05VV-F	30+2	482,00	1	018440330

## 1844SCK

enrolador de cabo elétrico automático, com cabo 3Gx1.5 mm<sup>2</sup> e tomada tipo SCHUKO

- cabo 3Gx1.5 mm<sup>2</sup>
- com interruptor de proteção térmica
- comprimento do cabo fora do tambor: 1 m
- cabo de entrada 1,5 m com tomada tipo SCHUKO
- mecanismo de cremalheira pode ser desativado para manter o cabo puxado
- potência máx. (cabo enrolado): 1500W (230V-20°C)
- potência máx. (cabo desenrolado): 2500W (230V-20°C)
- fornecido com suporte giratório 180° e um suporte adicional de ligação rápida

CE

IP42



L=15 m



Model	Cable	L (m)	€	Accessories	Code
1844 15-H05/SCK	H05VV-F	15+1	262,00	1	018440316
1844 15-H07/SCK	H07RN-F	14+1	284,00	1	018440318



## 1845

enrolador de cabo elétrico automático, com cabo 3Gx2.5 mm<sup>2</sup>

- cabo 3Gx2.5 mm<sup>2</sup>
- com interruptor de proteção térmica
- comprimento do cabo fora do tambor: 1 m (exceto for 1845 25-H07RN-F, 1.5 m)
- fornecido sem cabo de entrada
- mecanismo de cremalheira pode ser desativado para manter o cabo puxado
- potência máx. (cabo enrolado): 2000W (230V-20°C)
- potência máx. (cabo desenrolado): 3000W (230V-20°C)
- fornecido com suporte giratório 180° e um suporte adicional de ligação rápida

CE

IP42



Model	Cable	L (m)	€	Accessories	Code
1845 12-H05	H05VV-F	12+1	520,00	1	018450365
1845 15-H07	H07RN-F	15+1	520,00	1	018450367
1845 25-H07	H07RN-F	25+1,5	655,00	1	018450377

## 1846

enrolador de cabo elétrico automático, com cabo 4Gx1.5 mm<sup>2</sup>

- cabo 4Gx1.5 mm<sup>2</sup>
- sem interruptor de proteção térmica
- comprimento do cabo fora do tambor: 1 m
- fornecido sem cabo de entrada
- mecanismo de cremalheira pode ser desativado para manter o cabo puxado
- potência máx. (cabo enrolado): 1400W (230V-20°C)
- potência máx. (cabo desenrolado): 1900W (230V-20°C)
- fornecido com suporte giratório 180° e um suporte adicional de ligação rápida

CE

IP42



Model	Cable	L (m)	€	Accessories	Code
1846 10-H05	H05VV-F	10+1	278,00	1	018460405
1846 10-H07	H07RN-F	10+1	288,00	1	018460407
1846 15-H05	H05VV-F	15+1	288,00	1	018460415

## 1847

enrolador de cabo elétrico automático, com cabo 4Gx2.5 mm<sup>2</sup>

- cabo 4Gx2.5 mm<sup>2</sup>
- sem interruptor de proteção térmica
- comprimento do cabo fora do tambor: 1 m
- fornecido sem cabo de entrada
- mecanismo de cremalheira pode ser desativado para manter o cabo puxado
- potência máx. (cabo enrolado): 2000W (230V-20°C)
- potência máx. (cabo desenrolado): 2700W (230V-20°C)
- fornecido com suporte giratório 180° e um suporte adicional de ligação rápida

CE

IP42



	L	€		
	m			
1847 10-H05	H05VV-F 10+1	299,00	1	018470420
1847 15-H07	H07RN-F 15+1	560,00	1	018470427

## 1848

enrolador de cabo elétrico automático, com cabo 5Gx1.5 mm<sup>2</sup>

- cabo 5Gx1.5 mm<sup>2</sup>
- sem interruptor de proteção térmica
- comprimento do cabo fora do tambor: 1 m
- fornecido sem cabo de entrada
- mecanismo de cremalheira pode ser desativado para manter o cabo puxado
- potência máx. (cabo enrolado): 1400W (230V-20°C)
- potência máx. (cabo desenrolado): 1900W (230V-20°C)
- fornecido com suporte giratório 180° e um suporte adicional de ligação rápida

CE

IP42



	L	€		
	m			
1848 10-H05	H05VV-F 10+1	311,00	1	018480510
1848 15-H07	H07RN-F 15+1	595,00	1	018480517

## 1852R1750

ferro de indução portátil



CE

- aquecimento e desaperto de parafusos, eixos e rolamentos sem recurso a chama
- permite o aquecimento de qualquer tipo de metal ferromagnético

Equipamento standard:

- duas ponteiras frontais, Ø 19 e 26 mm, para desaperto de porcas
- uma ponteira plana para aquecimento de superfícies
- uma ponteira flexível, 800 mm
- estojo em plástico

Características técnicas:

- voltagem entrada: 230V AC, 50/60 Hz
- amperagem entrada: máx. 7.5 A
- potência: máx. 1.75 kW

EQUIPAMENTO OPCIONAL

Ponteiras disponíveis noutras dimensões

VANTAGENS

Poupança de tempo: aquecimento rápido, extremamente preciso

Segurança: sem produção de chamas, segurança máxima do operador

Funcional: possibilidade de utilização com uma mão, fácil troca de bobinas

ÁREAS DE APLICAÇÃO

Indústria automóvel  
Manutenção industrial  
Indústria aeronáutica  
Indústria naval  
Indústria petroquímica

1852R1750	1.770,00	1	018520175
-----------	----------	---	-----------

480x370x130 mm - 4,5 kg

## 1852S-CNT

ponteira de contacto



1852S-CNT	130,00	1	018520520
-----------	--------	---	-----------

## 1852S-CC

ponteira de colher



1852S-CC	104,00	1	018520521
----------	--------	---	-----------

## 1852S-KR/CNT

kit peças de substituição para ponteira de contacto



1852S-KR/CNT	56,50	1	018520522
--------------	-------	---	-----------

## 1852S-L

ponteiras laterais



	Ø	M	L	€		
	mm		mm			
1852S-L 19	19	M6	220	52,50	1	018520501
1852S-L 20	20	M8	220	52,50	1	018520502
1852S-L 23	23	M10	220	52,50	1	018520503
1852S-L 26	26	M12	220	52,50	1	018520504
1852S-L 32	32	M16	220	52,50	1	018520505
1852S-L 38	38	M20	220	60,00	1	018520506
1852S-L 45	45	M22	220	66,00	1	018520507

## 1852S-F

ponteiras frontais



	Ø	M	L	€		
	mm		mm			
1852S-F 19	19	M6	220	52,50	1	018520508
1852S-F 20	20	M8	220	52,50	1	018520509
1852S-F 23	23	M10	220	52,50	1	018520510
1852S-F 26	26	M12	220	52,50	1	018520511
1852S-F 32	32	M16	220	52,50	1	018520512
1852S-F 38	38	M20	220	60,00	1	018520513
1852S-F 45	45	M22	220	64,00	1	018520514

## 1852S-FLESS

ponteira flexível



	L mm	€		
1852S-FL750	750	38,50	1	018520519
1852S-FL800	800	98,50	1	018520515
1852S-FL1000	1000	126,00	1	018520517
1852S-FL1500	1500	149,00	1	018520518

## 1852 S-PIATTE

ponteira plana



1852S-PIATTE	60,00	1	018520516
--------------	-------	---	-----------



## 1808

ferro de soldar bivalente, fornecido com uma ponteira direita em aço 1824R8



W	V	€	🔌	📄
20/130	230	95,00	1	018080001

## 1812 150

ferro de soldar instantâneo



W	V	€	🔌	📄
150	230	136,00	1	018120015

## 1814M

ferros de soldar com pontas de aço



W	V	€	🔌	📄
25	230	76,50	1	018140225
30	230	80,50	1	018140230
40	230	87,50	1	018140240

## 1820

ferros de soldar



1820 30 30W L = 210mm	€ 56,50	1	018200003
1820 60 60W L = 220mm	€ 64,50	1	018200006
1820 80 80W L = 260mm	€ 91,50	1	018200008

## 1822

ferros de soldar de alta performance



1822 120 120W LxA = 250x125 mm	€ 139,00	1	018220012
1822 180 180W LxA = 250x125 mm	€ 148,00	1	018220018
1822 320 320W LxA = 250x140mm	€ 184,00	1	018220032

## 1823 60

aparelho de soldar digital fornecido com ferro de soldar

- Amplitude térmica: 160 °C ÷ 480 °C com ±1% precisão
- Modo de memorização concebido para guardar a temperatura seleccionada ao desligar o aparelho
- 3 teclas de selecção rápida (200-300-400 °C).



W	€	🔌	📄
60	540,00	1	018230060

## 1823R/60

ferro de soldar sobresselente para artigo 1823 60



1823R 60	€ 107,00	1	018230066
----------	----------	---	-----------



## 1824R

ponteiras de substituição para ferros de soldar

1824R 08 1808	€ 40,50	1	018240100
1824R 12 1812/150	€ 5,50	1	018240301
1824R 14-M25 1814M/25	€ 5,50	1	018240152
1824R 14-M30 1814M/30	€ 5,50	1	018240153
1824R 14-M40 1814M/40	€ 5,50	1	018240154
1824R 20 1820/30	€ 7,20	1	018240302
1824R 60 1820/60	€ 7,20	1	018240303
1824R 80 1820/80	€ 10,50	1	018240304
1824R 120-180 1822/120 -/180	€ 84,50	1	018240305
1824R 320 1822/320	€ 108,00	1	018240307
1824R ST-60 1823-60	€ 14,90	1	018240308

## 1825B

fio de soldar em latão com antioxidante

- 1 mm<sup>2</sup>; 250 g
- Sn 99.3%; Cu 0.7%



1825B	€ 79,50	1	018250251
-------	---------	---	-----------

## 1827

máquina de soldar a gás, ajustável



1827	€ 171,00	1	018270001
------	----------	---	-----------

## 1827PC

bicos cónicos para artigo 1827



1827PC 1,6	€ 35,50	1	018270501
1827PC 3,2	€ 35,50	1	018270502

## 1827PCL

ponteiras tipo faca para artigo 1827



1827PCL 2,4	€ 35,50	1	018270503
-------------	---------	---	-----------



## 1827PFL

peça de substituição para artigo 1827



1827PFL € 35,50 1 018270504

## 1827/K

aparelho de soldar a gás com 7 acessórios em caixa de polietileno macio



- Potência: 30 watts a 125 watts
- Temperatura dos bicos pode ser ajustada entre 250 °C e 500 °C
- Regulador de fluxo do gás
- Tempo de aquecimento: 15 segundos
- Tanque contém gás para operar 120 minutos sem paragens
- Tanque claro para visualizar o nível de gás
- Pode ser cheio com gás butano

1827/K € 264,00 1 018270100

## 1827F

maçarico recarregável de gás butano

- Depósito 35 g
- Três bicos intercambiáveis: 550 °C; 1000 °C; 1300 °C
- Fornecido com base e estojo rígido



1827F € 187,00 1 018270200

## 1830T

bomba dessoldadora com bico anti-estático em material plástico (PTFE)



L mm 190 € 20,10 5 018300021



## 7041LCD/4S

máscara de soldadura com LCD de escurecimento automático, para soldadura por eléctrodo; MIG/MAG; TIG e plasma.

4 sensores com filtro TRUE COLOR  
alimentação por célula solar e baterias de lítio para vida útil mais longa do filtro LCD

- Visor: 98x80 mm
- Amplitude de escurecimento: 5+8.5/ 9-13, ajustável internamente
- Proteção UV/IR: DIN16
- Tempo de escurecimento: 1/25000 s
- Tempo de clareamento: 0.1-2.0s
- Sensibilidade e tempo de escurecimento ajustáveis
- On/off automáticos
- Modo rebarbar
- Indicador bateria fraca

- Design ergonómico, leve, equilibrado
- Com porca de anel ajustável



7041LCD/4S € 343,00 1 070410001

## 7041LCD/4S-VE

protetor de lente à prova de riscos para item 7041LCD/4S

7041LCD/4S-VE € 8,40 2 070410101

## 7041LCD/4S-VI

lente interna para item 7041LCD/4S

7041LCD/4S-VI € 4,20 2 070410102

## 7042LCD

Máscara com LCD de escurecimento automático, para soldadura por eléctrodo; MIG/MAG; TIG e plasma.

Alimentação através de células solares e baterias de lítio para maior durabilidade do filtro LCD

- Área do visor: 98x43 mm
- Escurecimento: DIN 9-13, ajustável externamente
- Proteção UV/IR
- Tempo escurecimento: 1/25000s
- Tempo aclaramento: 0.25-1s
- Sensibilidade e tempo de escurecimento ajustáveis
- On/off automático
- Adequada para rebarbar
- Forma otimizada para que o utilizador respire mais facilmente com a máscara colocada



7042LCD € 240,00 1 070420001

## 7042LCD/RV

protector anti-riscos para artigo 7042LCD, 7043

7042LCD/RV € 3,75 2 070420101

## 7042LCD/RV-INT

lente interna para artigo 7042LCD, 7043

7042LCD/RV-INT € 3,30 2 070420102

## 7043

Máscara com LCD de escurecimento automático, para soldadura por eléctrodo, MIG/MAG, TIG e plasma, alimentação através de células solares

- área do visor: 92x43 mm
- escurecimento: DIN 9-13, ajustável externamente
- proteção UV/IR
- tempo de escurecimento: 1/1000 s
- tempo de aclaramento: 0.1-1.0 s
- tempo de escurecimento ajustável
- on/off automático
- adequada para rebarbar
- forma otimizada para que o utilizador respire mais facilmente com a máscara colocada



7043 € 139,00 1 070430001

# REPARAÇÃO DE VEÍCULOS

As nossas ferramentas para reparação de veículos, usadas pelos profissionais mais exigentes, são desenvolvidas e fabricadas para cumprir as normas mais rígidas a nível mundial, e são testadas com regularidade sob as mais difíceis condições de trabalho.

Há mais de 50 anos que temos o orgulho de trabalhar de mãos dadas com os melhores, que nos ajudam a melhorar continuamente os nossos produtos e são testemunhas dos mais elevados padrões de qualidade.

**As ferramentas de reparação de veículos encontram-se nas seguintes secções:**

<b>Diagnóstico</b>	itens 1464T/N a 1465 itens 1498SM a 1499 itens 1758VT a 1760/IR 1600
<b>Motor</b>	itens 955 a 960SN itens 1440 a 1462/KEP itens 1472 a 1485TC itens 1737 a 1759TT
<b>Óleo e filtros</b>	itens 1488/1 a 1496/C itens 1877 a 1889N
<b>Sistema elétrico</b>	itens 1489/33 a 1489Y itens 1497D a 1497RC
<b>Arrancadores</b>	itens 1498BC/12 a 1498DG1100E
<b>Transmissão</b>	itens 1884 a 1885/X C60 itens 1438 a 1438DSG itens 1566N a 1569/F
<b>Suspensão</b>	itens 1550U a 1567
<b>Travões</b>	itens 1466/C5 a 1471T/C5
<b>Rodas</b>	itens 720MRC a 729T itens 962 a 989B itens 1530/C5 a 1531/C7
<b>Carroçaria</b>	itens 1065F5 a 1068 itens 1302 a 1369/C11 itens 1478 a 1479U/32 itens 1505V a 1539 itens 1763 a 1768
<b>Outros equipamentos</b>	itens 1875LT a 3067
<b>Elevação</b>	itens 3006 a 3069

## 1875LT

lavadora de tapetes/estofos

Ideal para limpeza profunda de superfícies têxteis. Dispensa detergente pulverizado sob pressão e aspira-o com a sujidade, deixando as superfícies quase secas

Accessórios fornecidos:

- 1 tubo completo com cabo ergonómico
- 1 unidade dispensadora
- 2 extensões rígidas
- 1 bocal pequeno
- 1 bocal grande
- 6 contraporcas do cabo de alimentação

CE



1875LT € 660,00 1 018750000

## 1875SP/K3

kit de escovas para limpeza de tecidos

- 1 escova plana Ø 48 mm
- 1 escova plana Ø 100 mm
- 1 escova redonda Ø 90 mm
- chave de impacto 1/4"

1/4



ISO 1173 E 6,3

1875SP/K3 € 21,20 1 018750010

## 1877

aparador de óleo com rodas e depósito de 90 l

- indicador do nível
- depósito de grande diâmetro com grelha de retenção; capacidade 12 l
- purga do depósito pneumático através de tubo com 1.8 m
- tabuleiro para ferramentas

CE



1877 € 820,00 1 018770008

## 1877A

aparador de óleo / aspirador com rodas, depósito de 90 l e antecâmara

- indicador do nível
- depósito de grande diâmetro com grelha de retenção; capacidade 12 l
- antecâmara transparente: capacidade 9.5 l
- tubo de aspiração 1.8 m
- purga do depósito pneumático através de tubo com 1.8 m
- tabuleiro para ferramentas

Accessórios standard:

- 1 sonda rígida, Ø 5x700 mm
- 1 sonda flexível, Ø 5x700 mm
- 1 sonda rígida, Ø 6x600 mm
- 1 sonda flexível, Ø 6x700 mm
- 1 sonda flexível, Ø 7x700 mm
- 1 sonda flexível, Ø 8x700 mm
- adaptadores para VW, BMW, CITROËN

CE



1877A € 1.450,00 1 018770080

## 1877F

aparador de óleo para garrafas de 1 l

- capacidade até 4 garrafas em simultâneo
- fornecido com 2 garrafas 2 l



H mm 405 L mm 270 P mm 240 € 112,00 1 018770100

## 1877P

recuperador de óleo, com rodas,  
com depósito de polietileno

- capacidade do depósito: 40 l
- aparadeira de grandes dimensões em PP
- indicador do nível de óleo
- descarga pneumática



	H	min-Max	H1	€		
	mm	mm	mm			
1877P	1030-1630	900	40	635,00	1	018770180

## 1878 2

Tabuleiro de recolha de fluidos

- capacidade máxima: 2 L
- indicada para mudança de óleo em scooters



	l	H	€		
		mm			
1878 2	2	85	16,70	1	018780002

## 1878 4

Tabuleiro de recolha de fluidos portátil

- indicado para motocicletas
- capacidade máxima: 4 L
- salpicos reduzidos



	l	H	€		
		mm			
1878 4	4	100	35,50	1	018780004

## 1878 8

Tabuleiro de recolha de fluidos

- altura apropriada para motocicletas
- capacidade máxima: 8 L



	l	H	€		
		mm			
1878 8	8	110	18,90	1	018780008

## 1878 11

reservatório colector de fluido

- Capacidade máxima: 11 l
- Válvula drenagem de fluidos
- Revestimento interior para prevenir fugas de fluido durante o transporte



	l	€		
1878 11	11	42,00	1	018780011

## 1878 30

reservatório colector de fluido

- Capacidade máxima: 30 l
- Grelha anti-salpicos
- Equipado com 4 rodas giratórias

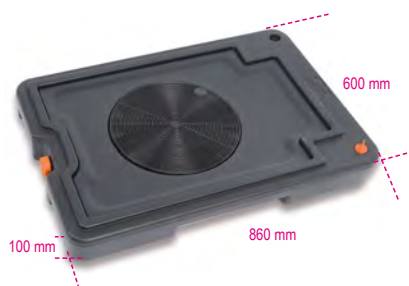

	l	€		
1878 30	30	163,00	1	018780030

## 1879

extractor manual/pneumático de fluido 9.5 l



	l	€		
1879 9,5	9,5	353,00	1	018790001

## 1879 6

extractor de líquidos com operação manual,  
6 l



	l	€		
1879 6	6	258,00	1	018790000

## 1879R/K4

jogo de 4 tubos de substituição para extractor  
de líquidos 1879



	€		
1879R/K4	68,50	1	018790504

## 1879/FUEL

Extractor de fluidos com operação manual 6 L

utilizado para hidrocarbonetos



	l	€		
1879/FUEL	6	153,00	1	018790010

## 1880

bomba manual para bidões

- para óleo
- não utilizar com líquidos aquosos, solventes ácidos, diesel, gasolina e similares
- fornecida com conexão para bidões, tubo telescópico e ponteira
- para utilização com bidões de 60, 100 e 200 l



	gr	€		
1880	240	66,50	1	018800001



## 1880ADB

bomba manual para bidons AdBlue

- 5 litros fornecidos a cada vinte voltas
- extensões até 1,20 m
- 1 conexão para bidons de passo fino
- 1 conexão para bidons de passo grosso



1880ADB € 155,00 1 018800101

## 1881

bomba pneumática, ratio 3:1

CE



1881 l/min 18 € 570,00 1 018810001

## 1882N

pistola de óleo com bico flexível e apanha-gotas automático



1882N € 171,00 1 018820110

## 1883N

contador digital para óleo



1883N € 241,00 1 018830036

## 1883NC

Bocal macho-macho, 1/2, para refs. 1882N e 1883N



1883NC € 15,00 1 018830135

## 1884

chave para filtros de óleo de caixas de velocidades e diferenciais manuais e automáticos

Com 12 adaptadores para ligação directa



1884 € 560,00 1 018840010

- |        |                                   |
|--------|-----------------------------------|
| AT-101 | FORD                              |
| AT-102 | UNIVERSAL (Bmw, Honda, Nissan...) |
| AT-103 | VW-AUDI                           |
| AT-104 | VW-AUDI-PORSCHE                   |
| AT-105 | VW-AUDI-MINI COOPER               |
| AT-106 | MERCEDES                          |
| AT-107 | DSG                               |
| AT-108 | VW-AUDI CVT                       |
| AT-109 | VOLVO                             |
| AT-110 | TOYOTA-LEXUS                      |
| AT-111 | SKODA                             |
| AT-112 | VW Passat/Tiguan <2007            |



## 1884N/C8

jogo 8 adaptadores para o item 1884

Inclui:

- 1 adaptador para Infiniti, 7 velocidades, M8x1.0
- 1 adaptador para Honda, Hyundai, Kia 5x8x200 mm
- 1 adaptador para Skoda M18x1.5
- 1 adaptador para Mini M14x1.5
- 1 adaptador para Nissan M10x1.5
- 1 adaptador para Nissan Juke M12x1.25
- 1 adaptador para GM M12x1.75
- 1 adaptador para veículos grupo VAG, 7 velocidades



1884N/C8 € 136,00 1 018840200

200x145x40 mm - 400 g

## 1889N

base em aço para movimentação e armazenagem de bidões 2 200-l

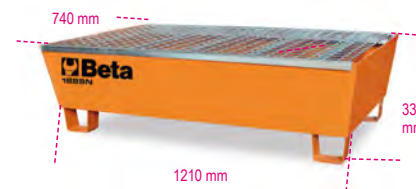

1889N € 930,00 1 018890220

## 1889CF

chave universal para bidons

- 1 sextavado fêmea Ø 38 mm
- 1 perfil de 4 setores Ø 42 mm
- 1 lâmina 16,5x4 mm



L mm 270 € 39,50 1 018890010

## 1885

Estação de manutenção para caixa de velocidades automáticas

Permite que o processo de limpeza seja feito de forma segura em todas as caixas de velocidades automáticas. As manutenções evitam danos causados pelo óleo degradado nas caixas de velocidades automáticas, prevenindo: excesso de ruído na caixa de velocidades, engrenagens, cheias e engatadas, tempo de mudança de velocidade longo.

CE



Funcionalidades  
Automática

Processo seguido passo a passo com banco de dados integrado  
Permite igualar a quantidade de óleo inserido com o utilizado, garantindo assim a quantidade adequada de óleo no sistema.  
Caudalímetro para inspeção visual da quantidade de óleo.  
Relatório de operação.

ESPECIFICAÇÕES AUTOMÁTICAS

Injeção de óleo (opcional)  
Sistema de lavagem da caixa de velocidades  
Retirar o óleo do depósito  
Retirar o óleo do conversor  
Injeção de óleo no conversor

Especificações técnicas  
Alimentador: 220 V 50 Hz

2 balanças eletrônicas, resolução +/- 10 g  
Cartão eletrónico com ecrã gráfico iluminado

1885 € 9.900,00 1 018850010

## 1885/C1-R1

acessórios para transmissão Land Rover Freelander para item 1885  
Ic01430



1885/C1-R1 € 74,00 1 018850111

## 1885/C1-R2

acessório para transmissão DP0 para item 1885  
Ic0990



1885/C1-R2 € 129,00 1 018850112

## 1885/C1-R6

acessórios para transmissão AISIN TG82 para item 1885  
Ic01820



1885/C1-R6 € 142,00 1 018850116

## 1885/C1-R8

acessórios para transmissão Renault-Nissan para item 1885  
Ic02150



1885/C1-R8 € 142,00 1 018850118

## 1885/C2-R1

acessórios para transmissão sem permutador Audi 8HP para item 1885  
Ic0993



1885/C2-R1 € 139,00 1 018850121

## 1885/C2-R6

acessórios para transmissão Audi Q5-Q7 para item 1885  
Ic0680



1885/C2-R6 € 133,00 1 018850126

## 1885/C2-R7

acessórios para transmissão Audi 0B5 para item 1885  
Ic01720



1885/C2-R7 € 80,00 1 018850127

## 1885/C3-R3

acessórios para transmissão Toyota IQ para item 1885  
Ic0991



1885/C3-R3 € 142,00 1 018850133

## 1885/C3-R4

acessórios para transmissão Mazda para item 1885  
Ic02130



1885/C3-R4 € 142,00 1 018850134

## 1885/C3-R5

acessórios para transmissão Renault Laguna-Esp para item 1885  
Ic02150



1885/C3-R5 € 142,00 1 018850135

## 1885/C3-R6

acessórios para transmissão Nissan Juke para item 1885  
Ic02140



1885/C3-R6 € 142,00 1 018850136



### 1885/C3-R7

acessórios para transmissão AISIN TF71 FV para item 1885  
lc01420



1885/C3-R7 € 142,00 1 018850137

### 1885/C3-R8

acessórios para transmissão AISIN TF71 FP para item 1885  
lc001420/1



1885/C3-R8 € 142,00 1 018850138

### 1885/C3-R9

acessórios para transmissão AISIN TF71 FO para item 1885  
lc001420/2



1885/C3-R9 € 142,00 1 018850139

### 1885/C3-R10

acessórios para transmissão AISIN TF71 FS para item 1885  
lc001420/3



1885/C3-R10 € 142,00 1 018850140

### 1885/XC60

acessórios para transmissão Volvo XC60 para artigo 1885



1885/XC60 € 153,00 1 018850151

### 1893/134A

Estação de carregamento automático para ar condicionado a gás R134a

Modelo automático, completo com base de dados de carros/camiões com quantidades de gás, quantidades e tipos de óleo do compressor, software de autodiagnóstico para trabalhos de manutenção de rotina. Base de dados pode ser atualizada através do software. A máquina pode funcionar em modo manual (com a condição de ser controlada por um utilizador) e em modo automático (não é necessário o controlo do utilizador).



R134A (250 ml)

#### FUNCIONALIDADES

Automático  
Base de dados de carros/camiões com quantidades de gás, quantidades e tipos de óleo do compressor  
Recuperação automática do tubo de gás  
Recuperação automática do gás  
Compensação da quantidade de gás recarregada nas tubagens  
Descarga automática de gases não condensados  
Relatório de erros e manutenção necessária  
Medidor ø 80 mm  
Leitura digital

#### ESPECIFICAÇÕES TÉCNICAS

Tanque de gás: 15kg  
Bomba de vácuo: 75 l/min  
Balança eletrónica: 50kg  
Cartão eletrónico com iluminação  
Taxa de recuperação: 500 rpm  
Alimentação: 220 V

1893/134A € 7.200,00 1 018930001

### 1893/1234YF

Estação de carregamento automático para ar condicionado a gás R1234yf

Modelo automático, completo com base de dados de carros/camiões com quantidades de gás, quantidades e tipos de óleo do compressor, software de autodiagnóstico para trabalhos de manutenção de rotina. Base de dados pode ser atualizada através do software. A máquina pode funcionar em modo manual (com a condição de ser controlada por um utilizador) e em modo automático (não é necessário o controlo do utilizador).



1234YF (250 ml)

#### FUNCIONALIDADES

Automático  
Base de dados de carros/camiões com quantidades de gás, quantidades e tipos de óleo do compressor  
Recuperação automática do tubo de gás  
Compensação da quantidade de gás recarregada em tubulações  
Descarga automática de gases não condensados  
Relatório de erros e manutenção necessária  
Medidor ø 80 mm

#### ESPECIFICAÇÕES TÉCNICAS

Tanque de gás: 15kg  
Bomba de vácuo: 75 l/min  
Balança eletrónica: 50kg  
Cartão eletrónico com iluminação  
Taxa de recuperação: 500 rpm  
Alimentação: 220 V

1893/1234YF € 7.450,00 1 018930012

### 1893TR/134A

R134a líquido de deteção de fugas para compressores híbridos A/C



1893TR/134A ml 250 € 50,50 1 018930901

### 1893TR/1234YF

R1234yf líquido de deteção de fugas para compressores híbridos A/C



1893TR/1234YF ml 250 € 58,00 1 018930902





## 1893TR/CI

líquido de deteção de fugas para compressores híbridos A/C



1893TR/CI 250 ml € 60,00 1 018930903

## 1895GSI

gerador de sinal para eletroinjetores (gasolina e GPL)

A definição de parâmetros de frequência e de tempo permite ativar os eletroinjetores, para uma limpeza eficaz em tanques de limpeza ultrassônicos ou operações de diagnóstico.



Especificações técnicas:

- Alimentação: 110V - 220V
- Duração: 0-99 min.
- RPM: 600-4000

1895GSI 164,00 € 1 018950810

## 1895/S

Acessório para tanques de limpeza ultrassônicos 1895

Permite o posicionamento correto dos injetores no tanque ultrassônico durante a limpeza.

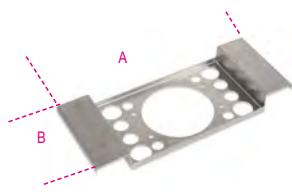

1895S A mm 340 B mm 140 € 127,00 1 018950501

# Beta

## 1895 6

tanque de limpeza ultrassônico, 6 l

com função especial de degas (eliminação de bolhas)



- A limpeza ultrassônica processa-se através do aquecimento do fluido para uma boa limpeza das peças de substituição, componentes metálicos em geral (injetores, carburadores, válvulas etc.)
- Ecrã digital para seleção da temperatura e tempo de limpeza.
- Dois modos de limpeza: "suave" e "normal".
- Para limpeza normal, utilize apenas água a uma temperatura de 50/60 °C
- Para uma limpeza mais precisa, adicione detergentes não-espumosos específicos para tanques ultrassônicos
- Ao utilizar o modo de degas acelera a libertação de ar no tanque, melhorando, assim, a eficiência da limpeza ultrassônica.

### CARACTERÍSTICAS TÉCNICAS

Capacidade do tanque: 6 l  
Torneira de purga  
Potência: 150 W  
Potência de aquecimento: 300 W  
Amplitude térmica: 0+80 °C  
Intervalo de tempo de limpeza: 0-99 minutos  
Frequência: 40 kHz  
Voltagem: 220/230V  
Dimensões gerais: 330x180x310 mm  
Dimensões do tanque: 300x155x150 mm  
Dimensões do cesto: 250x105x100 mm  
Capacidade máxima: 5.5 kg

1895 6 Max 5,5 € 830,00 1 018950060

## 1895 13

tanque de limpeza ultrassônico, 13 l

com função especial de degas (eliminação de bolhas)



- A limpeza ultrassônica processa-se através do aquecimento do fluido para uma boa limpeza das peças de substituição, componentes metálicos em geral (injetores, carburadores, válvulas etc.)
- Ecrã digital para seleção da temperatura e tempo de limpeza.
- Dois modos de limpeza: "suave" e "normal".
- Para limpeza normal, utilize apenas água a uma temperatura de 50/60 °C
- Para uma limpeza mais precisa, adicione detergentes não-espumosos específicos para tanques ultrassônicos
- Ao utilizar o modo de degas acelera a libertação de ar no tanque, melhorando, assim, a eficiência da limpeza ultrassônica.

### CARACTERÍSTICAS TÉCNICAS

Capacidade do tanque: 13 l  
Torneira de purga  
Potência: 300 W  
Potência de aquecimento: 400 W  
Amplitude térmica: 0+80 °C  
Intervalo de tempo de limpeza: 0-99 minutos  
Frequência: 40 kHz  
Voltagem: 220/230V  
Dimensões gerais: 350x325x320 mm  
Dimensões do tanque: 325x235x145 mm  
Dimensões do cesto: 257x185x100 mm  
Capacidade máxima: 12 kg

1895 13 Max 12 € 1.290,00 1 018950130

## 1895 27

tanque de limpeza ultrassônico, 27 l

com função especial de degaseificação



- A limpeza ultrassônica baseia-se no aquecimento do fluido para limpar eficazmente peças de substituição e componentes metálicos em geral (carburadores, válvulas etc.)
- Monitor digital para seleção da temperatura e tempo de limpeza
- Dois modos de limpeza: "suave" e "normal"
- Para limpeza normal, utilize apenas água a uma temperatura de 50/60 °C
- Para uma limpeza mais profunda, adicione uma solução de detergente sem formação de espuma específica para tanques ultrassônicos
- A utilização do modo degaseificação acelera a movimentação de ar através do tanque, melhorando a eficiência da limpeza ultrassônica

### CARACTERÍSTICAS TÉCNICAS

Capacidade do tanque: 27 l  
Torneira de purga  
Potência: 500 W  
Potência de aquecimento: 500 W  
Intervalo temperatura: 0+80 °C  
Tempo de limpeza: 0-99 minutos  
Frequência: 40 kHz  
Potência entrada: 220/230V  
Dimensões: 530x330x380 mm

1895 27 Max 25 € 1.790,00 1 018950270



## 1895 157

tanque de limpeza ultrassônico, 157 l

- A limpeza ultrassônica processa-se através do aquecimento do fluido para uma boa limpeza das peças de substituição, componentes metálicos em geral (cabecas de motor, transmissão, catalisadores, etc.)
- Tanque em aço inoxidável AISI304
- Controlador de tempo/frequência
- Termostato de regulação da temperatura
- 4 rodízios (2 com travões) para transporte
- Cabo de alimentação do tanque com ficha industrial 3P+N+T (3 polos + neutro + terra)
- Cabo de alimentação do controlador com ficha Schuko



Características técnicas:

- Capacidade do tanque: 157 l
- Torneira de purga
- Potência: 2160 W
- Potência de aquecimento: 5000 W
- Temperatura range: 30÷110 °C
- Intervalo de tempo de limpeza: 0-59 minutos
- Frequência dupla: 28 kHz e 40 kHz
- Potência: 220-380V / 240-415V
- Dimensões gerais: 840x640x750 mm
- Dimensões do tanque: 700x500x450 mm
- Dimensões do cesto: 680x480x200 mm
- Capacidade máxima: 62 kg
- Alimentação do gerador: 220 V
- Potência do gerador: 2400 Watt
- Frequência do gerador: 40 kHz

	L	P	H	€		
	mm	mm	mm			
1895 157	840	640	750	8.250,00	1	018950357

## 1895/RC

grelha para tanques de limpeza ultrasônicos 1895



	L	L1	A	€		
	mm	mm	mm			
1895/RC6	250	105	100	52,50	1	018950506
1895/RC13	257	185	100	83,00	1	018950513
1895/RC27	450	250	150	140,00	1	018950527

## 9881U



9881U 1 (1-2)	578
9881U 1 (3)	578

## 9882R



9882R 1 (1-2)	578
9882R 1 (3)	578

## 1898/K40

Tanque manual de limpeza por recirculação de componentes mecânicos, com aquecimento de fluidos e bactérias

- sem os custos de eliminação de solventes ou hidrocarbonetos
- utilizando o detergente ecológico Beta, à base de enzimas e bactérias, permite que os resíduos de óleo sejam removidos e eliminados dos componentes mecânicos
- a função enzimática ajuda a separar a parte oleosa da parte sólida suja; as bactérias transformam essa parte em dióxido de carbono e água, mantendo assim o detergente regenerado



Equipamento:

- escova de cerdas longas com ligação para mangueira
- com dupla ligação, para operar à esquerda e à direita
- grelha perfurada em aço inoxidável
- rodas com travões
- indicação da temperatura de funcionamento e alerta de níveis mínimos

ACESSÓRIOS:

- 2 latas 20 l de detergente ecológico e 2 packs de bacteria

DADOS TÉCNICOS

- Capacidade máxima da bomba: 10 l/min
- Capacidade do tanque: 40 l
- Temperatura de funcionamento: +5°C + +40°C
- Dimensões: 900 x 1000 x 750 mm
- Peso: 50 kg (vazio)

1898/K40	5.300,00	1	018980004
----------	----------	---	-----------

ATENÇÃO:

Países onde é autorizada a distribuição do artigo 1898/K40: Áustria, Bélgica, França (a partir de 2021), Húngria, Itália, Países Baixos, Polónia, Portugal, Espanha, Reino Unido.

## 1898/B

bactérias, embalagem 300 ml, para tanque de limpeza de componentes mecânicos 1898/K40



1898/B	109,00	1	018980904
--------	--------	---	-----------

ATENÇÃO:

Países onde o item 1898/B pode ser distribuído: Áustria, Bélgica, França, Itália, Holanda, Polónia, Portugal, Reino Unido, Espanha, Hungria

## 1898/C

pulverizador com rodas, 25 l

Particularmente útil numa variedade de setores: aeronáutica, agricultura, automóvel, limpeza, construção civil e rodoviária, indústria química, indústria transformadora, indústria mineira, camiões de lubrificação e veículos industriais, construção naval e transporte ferroviário.

- dupla função: pulverização e espuma
- depósito em aço pintado
- bico em aço inox
- mangueira anti-torção
- manómetro do depósito
- indicador do nível do depósito



Características técnicas:

- Capacidade do depósito: 25 l
- Comprimento da mangueira de alimentação: 5 m
- Pressão máxima de trabalho: 4-5 bar
- Comprimento do bico: 0.65 m
- Pressão máxima do depósito: 8 bar

	H	L	P	€		
	mm	mm	mm			
1898/C	810	360	360	284,00	1	018980940

## 1898/D

detergente líquido ecológico, embalagem 20 l, para tanque de limpeza de componentes mecânicos 1898/K40



1898/D	217,00	1	018980920
--------	--------	---	-----------

ATENÇÃO:

Países onde o item 1898/B pode ser distribuído: Áustria, Bélgica, França, Itália, Holanda, Polónia, Portugal, Reino Unido, Espanha, Hungria

## 1898/M

pulverizador  
com depósito 1,5 l

- bico ajustável com jato direto e pulverização de névoa
- escala graduada 0,5 l - 1 l - 1,5 l
- alavanca de bloqueio para jato contínuo
- não deve ser utilizado com hidrocarbonetos



H mm	l	€		
340	1,5	17,60	1	018980930

## 1898/S

bomba hidráulica manual  
com depósito 5 l

- bico em aço inox
- alavanca de bloqueio para jato contínuo
- bico ajustável com jato direto e pulverização de névoa
- alça ara facilitar o transporte
- punho ligação do bico
- tubo 1.2 m comprimento
- não deve ser utilizada com hidrocarbonetos



H mm	l	€		
415	5	30,50	1	018980932



## 1899A

máquina de limpeza sistema DPF/FAP®

Podem ser usados detergentes especiais periodicamente para limpar e restaurar sistemas DPF e FAP® danificados por depósitos de fuligem e cinzas.



Inclui:

- 1 tubo de alimentação 2 m comprimento
  - 1 união rápida + bocal para mangueiras de sensor diferencial
  - 1 bocal de mangueira niple M18x1.5 para ligação direta à sonda lambda
  - 1 extensão de mangueira
  - 1 bico de pulverização DPF/FAP®
  - 1 suporte de tubo magnético
  - 1 tubo com prensa-cabo de ajuste plus niple M14/16/18 mm para ligação a sondas lambda
- Especificações técnicas:
- voltagem de funcionamento: 12 V
  - comprimento do cabo de alimentação: 3.9 m
  - capacidade do reservatório: 1 l

1899A	1.450,00	1	018990010
-------	----------	---	-----------

## 1899SI

aparelho 2-em-1 para limpeza de injetores e de coletor de admissão

possibilidade de utilização de detergentes especiais para limpeza periódica dos injetores e do coletor de admissão em motores a diesel e gasolina, removendo depósitos de carbono e resíduos de combustão



Especificações:

- Voltagem: 12 V
- 2 tubos com uniões rápidas
- 2 depósitos (capacidade: 1l cada)

1899SI	5.450,00	1	018990030
--------	----------	---	-----------

## 2080/VG

porta-ferramentas em ABS com compartimentos giratórios

- Com organizador superior para peças pequenas (145 mm de diâmetro) e 4 compartimentos giratórios:
  - 1 compartimento com 305 mm de diâmetro
  - 3 compartimentos com 445 mm de diâmetro
- Fornece com 12 divisórias para utilização em 3 compartimentos giratórios maiores, para obter até 8 compartimentos por nível



2080/VG	196,00	1	020800100
445x445x550 mm - 3,4 kg			

## 2250-0

Banco giratório com tabuleiros, vazio



2250-0	126,00	1	022500011
--------	--------	---	-----------

## 2251N

banco giratório com gavetas

- banco redondo giratório, ajustável em altura através de mecanismo de pistão a gás (445-580 mm)
- compartimento para ferramentas quadrado (380 mm) com 2 gavetas (2+1)
- dimensões das gavetas: 350x180x90 mm
- dimensões dos tabuleiros para ferramentas: 2X 190x190mm - 1X 380x190mm
- 4 rodízios, Ø 75 mm



L	L1	H min+Max	€	
380	380	445+580	169,00	1 022510012



**2252**  
banco rolante



2252-G € 211,00 1 022520002

**2252KR4**  
rodízios de substituição para banco 2252



2252KR4 € 71,00 1 022520900

**2258N-0**  
banco com compartimento para ferramentas



2258N-0 € 217,00 1 022580021

**2258RR**  
rodízio de substituição para artigo 2258N



2258RR € 12,00 1 022580111

**2254A**  
capa de proteção para veículos, para utilização ao ar livre, impermeável, com proteção contra raios UV

Ideais para proteger veículos danificados enquanto esperam para ser reparados

Características técnicas:

- acabamento exterior com proteção UV
- interior macio com acabamento anti-riscos
- 6 cordões para ajustar a capa ao veículo
- 2 fechos de correr junto às portas frontais para acesso ao veículo sem remover a capa
- espaço para espelho
- refletora



3 versões:

- tamanho M recomendado para veículos ligeiros compactos
- tamanho L recomendado para carrinhas
- tamanho XL recomendado para SUVs

	LxPxH mm	€		
/M	4400x1450x1300	177,00	1	022540002
/L	5300x1450x1150	198,00	1	022540000
/X	4700x1450x1580	181,00	1	022540001

**2254C**  
Proteção com ventosas para carroçarias

Em tecido com revestimento de borracha, com 4 ventosas na parte superior



	L1 mm	L2 mm	€		
2254C	1150	650	58,00	1	022540200



**2254F**  
Proteção frontal para veículo

Proteção frontal do veículo, com aberturas para faróis e radiador.



- Impermeável
- Resistente ao óleo e massa
- Fixão de correias
- Material: 98% poliamida / nylon, 2% de poliuretano

2254F € 99,00 1 022540150

**2254K**  
Protetores reutilizáveis de banco, volante e manete de mudanças

Adequado a bancos, volantes e manetes de mudanças da maioria dos carros



2254K € 34,00 1 022540101

**2254SM**  
Esteira em espuma EVA

- Duplo acabamento:
- 1 lado em espuma EVA suave
  - 1 lado em carbono rígido para melhorar deslizamento



2254SM € 78,00 1 022540033

## 2254T

Esteira pequena

Em espuma EVA antiderrapante



2254T € 34,50 1 022540047

## 3000L

estrado

• Cobertura em PVC forrado com borracha acolchoada para um maior conforto.

POSIÇÃO DA CABEÇA AJUSTÁVEL EM TRÊS POSIÇÕES

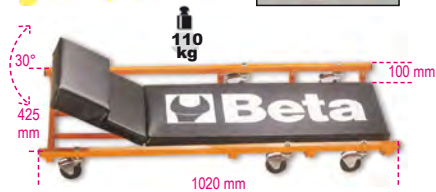

3000L € 200,00 1 030000210

## 3000L/RLS

rodízios de substituição para estrado



3000L/RLS € 14,50 6 030000212

## 3002

esteira e banco

• Estrutura em aço  
• Cobertura em PVC acolchoado  
• Facilmente convertível em esteira ou banco



3002 € 133,00 1 030020001

## 3002/RLS

jogo de 6 rodas de substituição para esteira/banco 3002



3002/RLS € 34,50 1 030020501

## 3003

esteira

em plástico anti-choque

• Ø das rodas: 76 mm



3003 € 104,00 1 030030001

## 3003/RLS

jogo de 6 rodas de substituição para esteira/banco 3003



3003/RLS € 53,50 1 030030501

## 3003C

Esteira em plástico à prova de embates

Completa com:

- acabamento tipo carbono nas zonas da cabeça e lombar\*
- placas em metal na parte superior para fixar acessórios metálicos
- 6 rodízios em borracha, 79 mm de diâmetro
- Capacidade máxima: 120 kg
- Peso: 5.5 kg



3003C € 280,00 1 030030100

## 3003C/RLS

jogo de 6 rodas de substituição para esteira 3003C



3003C/RLS € 112,00 1 030030600

## 3003PRO

Esteira em plástico à prova de embates

Completa com:

- almofada ergonómica para cabeça
- protetor suave de costas
- rodízios com rolamentos duplos para utilização em superfícies irregulares
- 1 rodízio
- 2 medidas de ajuste de altura: 38 ou 76 mm
- 2 Lâmpadas LED portáteis (250 lumens) com fixação magnética
- Capacidade máxima: 200 kg
- Peso: 7.7 kg



C max H min H Max H1  
kg mm mm mm  
200 170 230 230 € 392,00 1 030030150

## 3003PRO/SP

Suporte de parede para esteira 3003PRO

pode ser montado em paredes, sistemas de elevação, armários ou outros equipamentos, permitindo assim a fixação da esteira através de um sistema rápido com fecho de segurança.



3003PRO/SP € 105,00 1 030030151

## 3003PRO/PM

Suporte magnético para ferramentas, para esteira 3003PRO

pode ser aplicado nas jantes das rodas da esteira, para reter pequenas peças



3003PRO/PM € 11,30 1 030030152

## 3003PRO/RCR

rodas traseiras sobresselentes para esteira 3003PRO, par



3003PRO/RCR € 83,00 1 030030650



## 3003PRO/RRG

rodízio frontal sobresselente para esteira 3003PRO



3003PRO/RRG

€ 26,00



1 030030651

## 3003PRO/RT

lâmpada de inspeção LED com ímãs sobresselentes para esteira 3003PRO

- 250 lumens
- Pilhas 4xAAA (não incluídas)



3003PRO/RT

€ 18,90



1 030030652

## 3004

calço para rodas

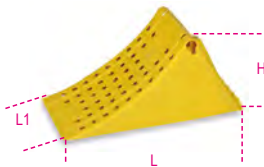

	H	L	L1
	mm	mm	mm
3004	225	475	200

€ 47,00



1 030040000



# Beta



## REPARAÇÃO DE VEÍCULOS

As nossas ferramentas para reparação de veículos, usadas pelos profissionais mais exigentes, são desenvolvidas e fabricadas para cumprir as normas mais rígidas a nível mundial, e são testadas com regularidade sob as mais difíceis condições de trabalho.

Há mais de 50 anos que temos o orgulho de trabalhar de mãos dadas com os melhores, que nos ajudam a melhorar continuamente os nossos produtos e são testemunhas dos mais elevados padrões de qualidade.

**As ferramentas de reparação de veículos encontram-se nas seguintes secções:**

### Diagnóstico

itens 1464T/N a 1465  
itens 1498SM a 1499  
itens 1758VT a 1760/IR 1600

### Motor

itens 955 a 960SN  
itens 1440 a 1462/KEP  
itens 1472 a 1485TC  
itens 1737 a 1759TT

### Óleo e filtros

itens 1488/1 a 1496/C  
itens 1877 a 1889N

### Sistema elétrico

itens 1489/33 a 1489Y  
itens 1497D a 1497RC

### Arrancadores

itens 1498BC/12 a 1498DG1100E

### Transmissão

itens 1884 a 1885/X C60  
itens 1438 a 1438DSG  
itens 1566N a 1569/F

### Suspensão

itens 1550U a 1567

### Travões

itens 1466/C5 a 1471T/C5

### Rodas

itens 720MRC a 729T  
itens 962 a 989B  
itens 1530/C5 a 1531/C7

### Carroçaria

itens 1065F5 a 1068  
itens 1302 a 1369/C11  
itens 1478 a 1479U/32  
itens 1505V a 1539  
itens 1763 a 1768

### Outros equipamentos

itens 1875LT a 3067

### Elevação

itens 3006 a 3069

## 3006

macaco para rodas de tratores e escavadoras

- capacidade máx.: 1,200 kg
- diâm. mín. da roda: 1,000 mm
- diâm. máx. da roda: 2,200 mm
- espessura máx. da roda: 800 mm

CE



3006

€ 2.100,00



1 030060000

## 3006 R/RGF

rodízio sobresselente com travão para macaco 3006



3006 R/RGF

€ 80,50



1 030060501

## 3006 R/RG

rodízio sobresselente para macaco 3006



3006 R/RG

€ 70,00



1 030060502

## 3007

trolley inferior para veículos sem rodas dianteiras / eixo traseiro

- Permite o fácil manuseamento de veículos sem rodas dianteiras ou eixo traseiro durante o trabalho
- 4 rodas giratórias, incluindo 2 com travão, adequadas para utilização em cabinas de pintura
  - 2 apoios móveis para adaptação a todos os chassis
  - capacidade máx.: 800 kg

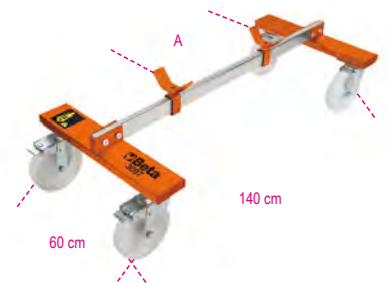

3007

A Max  
mm  
110

€ 855,00



1 030070001



## 3007 R/RGF

rodízio sobresselente com travão para trolley 3007



3007 R/RGF € 125,00 1 030070501

## 3007 R/RG

roda giratória sobressalente para trolley inferior 3007



3007 R/RG € 109,00 1 030070502

## 3008M

macaco e dispositivo de posicionamento para rodas de veículos pesados

capacidade: 136 kg

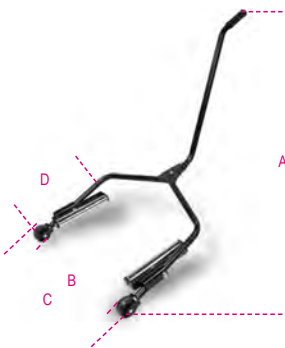

3008M A B C D € 142,00 1 030080210

## 3008N

macaco e dispositivo de posicionamento para rodas simples e duplas em veículos pesados

- capacidade máxima: 500 kg
- altura mínima: 120 mm
- altura máxima: 650 mm
- distância entre rolos: 429+670 mm
- dispositivo de segurança contra sobrecarga hidráulica
- rodas frontais giratórias

CE



3008N € 3.560,00 1 030080110

## 3009

Elevador para rodas

Capacidade máxima de elevação: 550 kg

4 rodas de apoio

Largura das rodas: 200 mm

Para rodas até 240 mm de largura

Ideal para:

- carregar automóveis danificados para camiões de reboque
- oficinas de reparação de automóveis
- movimentação de veículos em salas de exposições



3009 A B € 493,00 1 030090001

## 3009R/GR4

conjunto de 4 rodízios para elevador de rodas



3009R/GR4 € 202,00 1 030090501

## 3010/T...

preguiças, par



3010T 2 H1 max-min L L1

3010T 2 € 117,00 1 030100002

3010T 3 H1 max-min L L1

3010T 3 € 138,00 1 030100003

3010T 6 H1 max-min L L1

3010T 6 € 201,00 1 030100006

3010T 10 H1 max-min L L1

3010T 10 € 345,00 1 030100010

## 3011/T

macacos de garrafa hidráulicos

CE



3011T 2 C max H min H Max L

3011T 2 € 104,00 1 030110020

3011T 3,5 C max H min H Max L

3011T 3,5 € 117,00 1 030110035

3011T 5 C max H min H Max L

3011T 5 € 131,00 1 030110050

3011T 10 C max H min H Max L

3011T 10 € 196,00 1 030110100

3011T 15 C max H min H Max L

3011T 15 € 239,00 1 030110150

3011T 20 C max H min H Max L

3011T 20 € 300,00 1 030110200

3011T 32 C max H min H Max

3011T 32 € 311,00 1 030110320

3011T 50 C max H min H Max

3011T 50 € 360,00 1 030110500



## 3010H

preguiças para trabalhos pesados



C Max kg	H min mm	H Max mm	L mm	L1 mm
15,000	445	631	300	300

3010H631-T15 € 373,00 1 030100150

C Max kg	H min mm	H Max mm	L mm	L1 mm
15,000	645	1077	300	300

3010H1077-T15 € 468,00 1 030100165

## 3010V

preguiças para trabalhos pesados,  
regulação com parafuso



C Max kg	H min mm	H Max mm	L mm	L1 mm
20,000	410	600	330	330

3010V600-T20 € 545,00 1 030100200

C Max kg	H min mm	H max mm	L mm	L1 mm
20,000	665	1090	460	460

3010V1090-T20 € 690,00 1 030100220

## 3012

apoios para motor



L mm	C max kg	€		
1500	500	355,00	1	030120010
1800	400	481,00	1	030120018

## 3012C

suporte para motores

ideal para veículos ligeiros e comerciais



3012C € 940,00 1 030120255

## 3012I

suporte inferior para motores

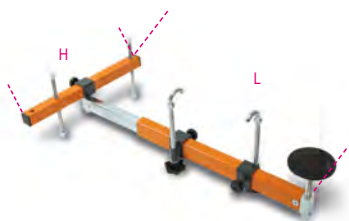

3012I L mm 630=960 H mm 190 € 835,00 1 030120250

## 3014

suporte para motores



3014 € 447,00 1 030140010

## 3014R/GR5

jogo de 5 rodas de substituição para suporte  
motores 3014



3014R/GR5 € 112,00 1 030140501

## 3014 SAR

Suporte para motores

Capacidade máxima: 450 kg



3014SAR € 1.640,00 1 030140360

## 3014SAR/RR

jogo de 4 rodas de substituição para suporte  
motores 3014SAR



3014SAR/RR € 178,00 1 030140370

## 3014SAR/I

Reservatório colector de fluido

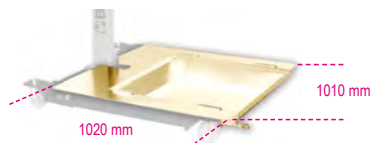

3014SAR/I € 480,00 1 030140361  
1020x1010x11 mm

## 3023

macaco de fossas  
com parafuso de ajuste

capacidade máxima de carga: 400 kg



3023 H min-Max mm 1350=2030 Ø mm 300 € 247,00 1 030230050

### 3024 0,6

grua hidráulica rebatível com bomba de duplo efeito

Características:

- Capacidade máxima de carga: 600 kg
- 5 posições de carga: 400-450-500-550-600 kg
- Com válvula de limite de carga e suporte cromado
- Velocidade de descida controlada
- Rodas de nylon
- Altura máxima: 2300 mm
- Raio de trabalho do braço: mín. 960 mm - máx. 1,350 mm
- Unidade de comando com rotação de 200°



H	H1	P	P1	€	1	030240006
mm	mm	mm	mm			
1540	2300	925	390	820,00		

### 3025N

grua hidráulica rebatível com bomba de duplo efeito

Especificações:

- capacidade máxima: 1 t
- 4 posições de carga: 300-600-800-1000 kg
- com válvula de limite de carga e suporte cromado
- velocidade de descida controlada
- rodas em nylon
- altura máxima: 2420 mm



A	B	C	D	€	1	030250110
mm	mm	mm	mm			
1560	1600	1000	880	2.530,00		

### 3025N/PF

pinça para bidons

capacidade máxima: 300 kg

CE



	A	B	€	1	030250111
mm	mm	mm			
3025N/PF	550=640	70	555,00		

### 3026 0,3

macaco de fossas hidráulico

CE



H min	H Max	L	L1	Ø	€	1	030260003
mm	mm	mm	mm	mm			
1120	1970	450	450	25	805,00		

### 3026/R0,3

jogo de 4 rodízios de substituição para macaco de fossas hidráulico 3026 0,3



	€	1	030260903
3026/R 0,3	203,00		

### 3026 0,5

Macaco de fossas hidráulico, 500 kg

CE

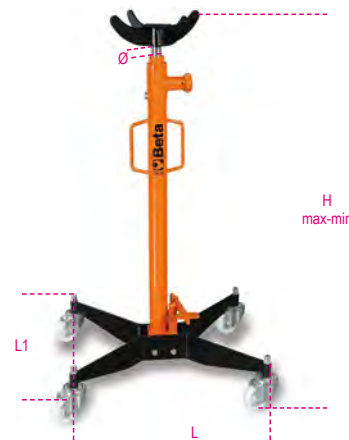

H min	H Max	L	L1	Ø	€	1	030260005
mm	mm	mm	mm	mm			
1140	1990	600	550	30	960,00		

### 3026/R0,5

jogo de 4 rodízios de substituição para macaco de fossas hidráulico 3026 0,5



	€	1	030260905
3026/R 0,5	284,00		

### 3026 1,0

macaco de fossas hidráulico

Capacidade máxima: 1 t

CE

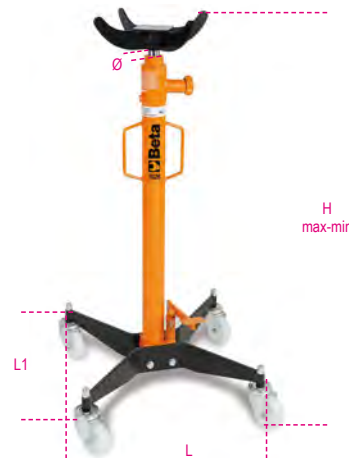

H min	H Max	L	L1	Ø	€	1	030260010
mm	mm	mm	mm	mm			
1140	1990	650	550	35	1.160,00		

### 3026/R 1,0

4 rodízios de substituição para macaco hidráulico item 3026 1,0



	€	1	030260910
3026/R 1,0	365,00		





## 3026/S

suporte giratório para transmissões com casquilho de redução para macacos de fossas ref. 3026

Capacidade máxima: 500 kg

CE



3026/S € 685,00 1 030260501

## 3026/SP

suporte de transmissão universal

permite a montagem e desmontagem de quaisquer transmissões por apenas um operador em veículos ligeiros, comerciais e todo-o-terreno de forma rápida e segura.

CE



3026/SP € 795,00 1 030260505

## 3026/SA

Suporte para rolamentos de rodas para macacos de fossas

• para trabalhos de manutenção em rolamentos ou substituição de amortecedores  
• pode ser adaptado aos macacos de fossas hidráulicos 3026 0,3 e 3026 0,5



3026/SA € 166,00 1 030260510

## 3026/SAM

Suporte para amortecedores para macacos de fossas

• para apoiar amortecedor quando o braço de suspensão é removido  
• suporte de amortecedor, diâmetro máximo 80 mm, mais adaptador para diâmetros máximos de 60 mm  
• pode ser adaptado aos macacos de fossas hidráulicos 3026 0,3 e 3026 0,5



3026/SAM € 214,00 1 030260515

## 3027N 10

pressa hidráulica de bancada com pistão

• capacidade máxima: 10 t  
• bomba manual de 2 velocidades  
• movimento por pistão  
• retorno automático do pistão  
• inclui jogo de prisms em V  
• suporte cromado

CE



3027N 10 € 2.230,00 1 030270101

## 3027N 20

pressa hidráulica com pistão

• capacidade máxima: 20 t  
• bomba manual de 2 velocidades  
• movimento por pistão  
• suporte cromado  
• retorno automático do pistão  
• dispositivo de segurança contra sobrecarga hidráulica  
• manómetro  
• inclui jogo de prisms em V

CE



3027N 20 € 3.090,00 1 030270102

## 3027N 30

pressa hidráulica com pistão e diferencial

• capacidade máxima: 30 t • bomba manual de 2 velocidades • movimento por pistão • suporte cromado • retorno automático do pistão • dispositivo de segurança contra sobrecarga hidráulica • manómetro • diferencial de cabo de aço para elevação

CE



3027N 30 € 5.400,00 1 030270103

## 3027N 50

pressa hidráulica com pistão e diferencial

• capacidade máxima: 50 t  
• bomba manual de 2 velocidades  
• movimento por pistão  
• suporte cromado  
• retorno automático do pistão  
• dispositivo de segurança contra sobrecarga hidráulica  
• manómetro  
• inclui jogo de prisms em V  
• diferencial de cabo de aço para elevação

CE



3027N 50 € 7.550,00 1 030270105

## 3027N 100

pressa eletro-hidráulica motorizada com pistão e diferencial

- capacidade máxima: 100 t
- motor trifásico: 230-400 V
- frequência: 50 Hz
- potência do motor elétrico: 3 kW
- bomba eletro-hidráulica de duas velocidades
- operado por alavanca de três posições: alimentação-neutro-retorno
- movimento por pistão
- pistão Ø: 100 mm
- diferencial de cabo de aço para elevação
- cabo de alimentação com ficha industrial de 4 polos (380V)
- inclui óleo do motor

CE

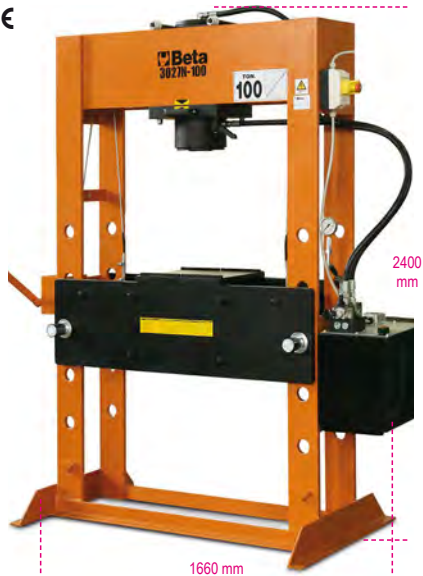

3027N 100	€ 23.200,00	1	030270110
-----------	-------------	---	-----------

## 3027N/KP

jogo de punções e placa para prensa 3027N



3027N/KP10-20	3027N10-20	€ 414,00	1	030270511
3027N/KP30	3027N 30	€ 580,00	1	030270531
3027N/KP50	3027N 50	€ 710,00	1	030270541
3027N/KP100	3027N 100	€ 1.300,00	1	030270552

## 3027N/KPP

pedal para prensas hidráulicas 3027N



3027N/KPP10	3027N 10-20-30	€ 442,00	1	030270560
3027N/KPP50	3027N 50	€ 505,00	1	030270565

## 3027PR/N

ferramenta de suporte para montar/desmontar cubos das rodas, rolamentos e sinoblocos

Sistema universal que permite ao utilizador montar/desmontar cubos das rodas, rolamentos e sinoblocos através de uma prensa com uma base de suporte e acessórios próprios. A ferramenta adapta-se a formas geométricas irregulares de cubos das rodas, pinos...  
A utilizar com prensas 3027N e 3028.



Características técnicas

- Amplitude de trabalho: min. 130mm - máx. 186mm
- Capacidade de carga máx.: 20 t

	L mm	P mm	€	1	030270410
3027PR/N	250	200	317,00		

## 3028 15

pressa hidráulica de bancada com pistão

capacidade máxima: 15 t  
regulação manual da altura  
movimento por pistão

CE



A mm	B mm	C mm	D mm	€	1	030280015
1010	565	480	80+370	1.220,00		

## 3028SP/15

resguardo de proteção para prensa 3028 15



3028SP/15	€ 177,00	1	030280016
-----------	----------	---	-----------

## 3028 20

pressa hidráulica com pistão móvel

capacidade máxima: 20 t  
regulação vertical da parte superior  
pistão deslizante

CE

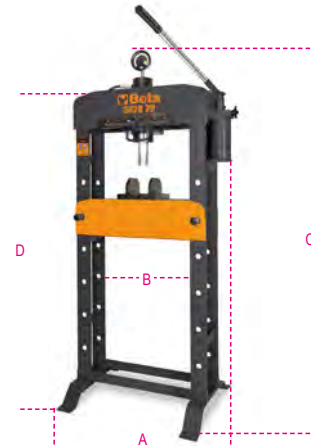

A mm	B mm	C mm	D mm	€	1	030280020
850	540	1830	1602	1.770,00		

## 3028SP/20

capa de proteção para prensas 3028 20



3028SP/20	€ 197,00	1	030280021
-----------	----------	---	-----------

## 3028 30

pressa hidráulica com pistão móvel

capacidade máxima: 30 t  
regulação vertical da parte superior  
pistão deslizante

CE

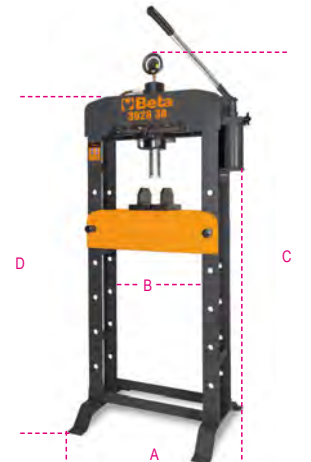

A mm	B mm	C mm	D mm	€	1	030280030
850	540	1850	1650	2.460,00		

## 3028SP/30

capa de proteção  
para prensas 3028 30



3028SP/30 € 197,00 1 030280031

## 3028 50

prensa hidráulica com pistão móvel e guincho

capacidade máxima: 50 t  
regulação vertical da parte superior através de guincho  
pistão deslizante

CE

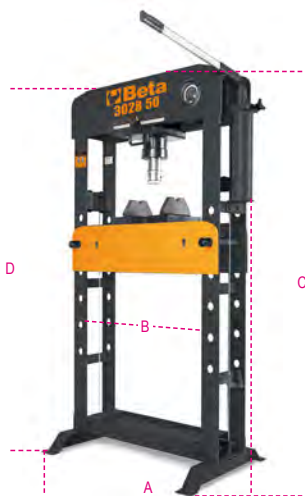

A mm 1100 B mm 750 C mm 1850 E mm 820 € 4.300,00 1 030280050

## 3028SP/50

capa de proteção  
para prensas 3028 50



3028SP/50 € 209,00 1 030280051

## 3028/KP

kit de punções e placa para prensas 3028



3028/KP € 153,00 1 030280055



## 3029/2T

Macaco hidráulico rebaixado, 2t com 4 rodas

- Pedal de aproximação
- Estrutura em aço e rodas em nylon
- Altura mínima: 75mm

CE



3029/2T € 490,00 1 030290020

## 3029L/2T

Macaco hidráulico rebaixado, longo, 2t

Permite trabalhar em veículos com altura reduzida e ponto de elevação recuado

- Controle da velocidade de descida
- Pedal de aproximação
- Rodas em nylon

CE



3029L/2T € 570,00 1 030290120

## 3029/2T-L/RP

placa de borracha de substituição 85-mm para  
itens 3029/2T e 3029L/2T



3029/2T-L/RP € 19,20 1 030290502

## 3029/2T-L/R6

roda traseira de substituição para itens  
3029/2T, 3029L/2T, 3030H/2T, 3033E/3T



3029/2T-L/R6 € 62,50 1 030290506

## 3029/2T-L/R5

roda frontal de substituição para macacos item  
3029/2T e item 3029L/2T



3029/2T-L/R5 € 58,00 1 030290505

## 3029AL/1.5T

macaco hidráulico em alumínio, 1,5 t

Especificações:

- Estrutura em aço
- Prática pega de transporte
- Saco de transporte em nylon incluído
- Rodas em nylon
- Placa revestida a borracha

Não adequado para utilização intensiva

CE



H min-max 88÷358 L 550 L1 240 € 480,00 1 030290015

## 3029AL/1,5T-R1

roda dianteira de substituição para macaco  
3029AL/1.5T



3029AL/1,5T-R1 € 10,90 1 030290530



### 3029AL/1,5T-R2

roda traseira de substituição para macaco 3029AL/1.5T



3029AL/1,5T-R2 € 13,10 1 030290531

### 3029AL/1,5T-RP

placa de borracha de substituição para macaco 3029AL/1.5T-RP



3029AL/1,5T-RP € 4,35 1 030290532

### 3030/2T

macaco hidráulico, 2 t com 6 rodas

- Duas rodas frontais giratórias em plástico (PTFE)
- Macaco hidráulico facilmente manobrável em superfícies irregulares
- Capacidade máxima: 2 toneladas

CE



3030/2T € 935,00 1 030300020  
43 kg

### 3030/2T-R5

roda dianteira de substituição para macaco hidráulico 3030 2T



3030 2T/R5 € 32,50 1 030300505

### 3030/2T-R6

roda traseira de substituição para artigo 3030/2T



3030 2T/R6 € 51,00 1 030300506

### 3030/2TRP

prato de borracha 85 mm sobresselente para ref. 3030/2T



3030/2TRP € 6,60 5 030300501

### 3030H/2T

macaco hidráulico de grande elevação, 2 t, com 6 rodas

- possibilita o trabalho em veículos elevados do chão e com um curso longo do amortecedor
- velocidade de descida controlada
- pedal de aproximação rápida
- rodas em nylon

CE



H min-Max mm 85-780 L mm 1010 L1 mm 300 € 780,00 1 030300220

### 3033/3T

macaco hidráulico, 3t versão longa

- Para utilização em veículos comerciais
- Capacidade máxima: 3 t
- Rodas em poliamida

CE



3033/3T € 1.240,00 1 030330030

### 3033E/3T

macaco hidráulico, 3 t

- velocidade de descida controlada
- rodas em nylon

CE



H min-Max mm 95-515 L mm 700 L1 mm 370 € 457,00 1 030330130

### 3033S 3T/R2

roda frontal de substituição para macaco 3033E/3T



3033S 3T/R2 € 52,50 1 030330532



# Beta

## 3035

carro para movimentação de pneus

- Para transporte fácil de pneus até 980 mm de diâmetro
- A estrutura robusta permite a movimentação de pneus sem ter de suportar o peso fisicamente
- Pode ser utilizado para posicionamento da roda
- 2 rodas Ø 260 mm
- 2 rodas Ø 125 mm
- Altura máx. de carga: 1.60 m
- Peso máx. de carga: 200 kg
- Garfos ajustáveis em 2 posições:  
primeira posição: abertura máxima 880 mm  
segunda posição: abertura máxima 980 mm



3035 € 1.130,00 1 030350100

## 3036

base para movimentação de pneus

Rodas anti-marca em borracha



3036 € 133,00 1 030360063

## 3061/2T

macaco hidráulico, 2 ton - 2 estádios



B	415 mm
C	250 mm
D	132-326 mm
E	2 t

Equipado com:

- diafragma três camadas de alta resistência e guia telescópica interna
- batente fim de curso e válvula de segurança contra sobrecarga
- pode ser utilizado com elevadores de garagem

CARACTERÍSTICAS TÉCNICAS

capacidade: 2 t  
peso: 14 kg  
pressão de trabalho: 8-10 bar  
altura: min.132 - max. 326 mm

3061/2T € 1.050,00 1 030610020

## 3061/2T-P50

extensão 50 mm para artigo 3061/2T



3061/2T P50 € 89,00 1 030610021

## 3061/2T-P100

extensão 100 mm para artigo 3061/2T



3061/2T P100 € 119,00 1 030610022

## 3065/20-10T

macaco hidráulico, 20-10 t, com mala

Portátil e leve, ideal para operações de assistência no exterior

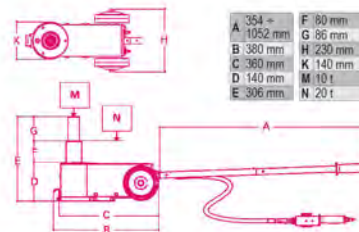

A	354 + 1052 mm	F	80 mm
B	380 mm	G	86 mm
C	360 mm	H	230 mm
D	140 mm	K	140 mm
E	306 mm	M	10 t
		N	20 t

- Fornecido com duas extensões, 75 e 60 mm de comprimento

CARACTERÍSTICAS TÉCNICAS

capacidade: 20-10 t  
peso: 23 kg  
pressão: 8-10 bar  
consumo de ar: 400 nl/min

3065/20-10T € 3.260,00 1 030650100

## 3065/40-20T

macaco hidráulico, 40/20 toneladas

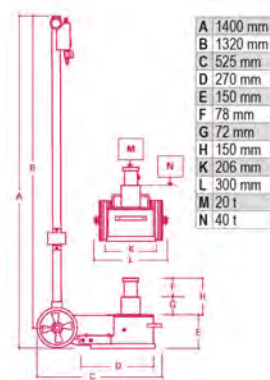

A	1400 mm
B	1320 mm
C	525 mm
D	270 mm
E	150 mm
F	78 mm
G	72 mm
H	150 mm
K	206 mm
L	300 mm
M	20 t
N	40 t



- adequado para veículos pesados
- funcional e de fácil manuseamento, também para transporte em oficinas móveis
- retorno automático do pistão
- duas válvulas de descida com comando da velocidade sob carga

CARACTERÍSTICAS TÉCNICAS

capacidade: 40/20 tons  
peso: 39 kg  
pressão de trabalho: 8-10 bar  
consumo de ar: 400 l/min

3065/40-20T € 3.470,00 1 030650200

## 3067/60-15T

macaco pneumático, 60-30-15 t

Com uma altura mínima de 120 mm, é particularmente adequado para utilização em veículos pesados de passageiros

CE

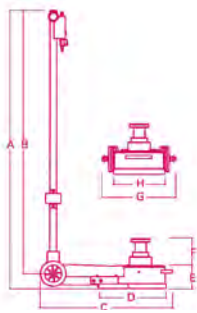

A	1385 mm
B	1315 mm
C	660 mm
D	330 mm
E	120 mm
F	135 mm
G	300 mm
H	250 mm

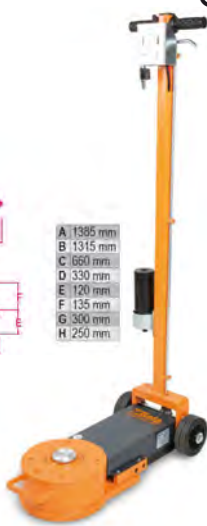

- Retorno automático do pistão
- Duas válvulas de descida com control o da velocidade sob carga
- Fornecido com duas extensões, 70 e 120 mm de comprimento

### CARACTERÍSTICAS TÉCNICAS

capacidade: 60-30-15 t

peso: 56 kg

pressão: 8-10 bar

consumo de ar: 600 l/min

3067/60-15T € 5.150,00 1 030670120

## 3067/70-13T

macaco hidráulico, 70-43-23-13 t

CE

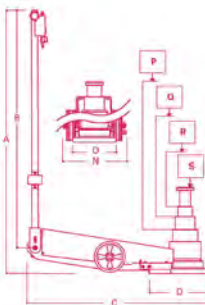

A	1430 mm
B	1320 mm
C	1000 mm
D	320 mm
E	150 mm
F	250 mm
G	60 mm
H	68 mm
L	56 mm
M	66 mm
N	350 mm
O	240 mm
P	70 t
Q	43 t
R	23 t
S	13 t

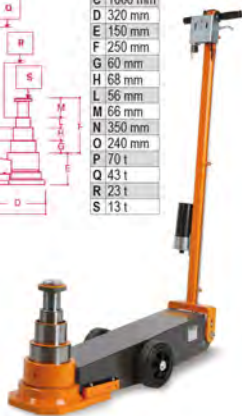

Versão longa, adequada para utilização em veículos pesados, articulados, pesados de passageiros e máquinas agrícolas

- retorno automático do pistão
- duas válvulas de descida com controlo da velocidade sob carga

### CARACTERÍSTICAS TÉCNICAS

capacidade: 70-43-23-13 tons

peso: 74 kg

pressão de trabalho: 8-10 bar

consumo de ar: 600 l/min

3067/70-13T € 6.450,00 1 030670130

## 3068

porta-paletes manual com braços rebaixados

CE



### CARACTERÍSTICAS TÉCNICAS:

- capacidade máxima: 2500 kg
- comprimento total: 1200 mm
- comprimento dos braços: 800 mm
- largura dos braços: 540 mm
- largura individual do braço: 160 mm
- altura da alavanca: 1230 mm
- altura máx. de elevação: 115 mm

3068 € 920,00 1 030680000

## 3069

porta-paletes manual

CE



### CARACTERÍSTICAS TÉCNICAS:

- capacidade máxima: 2.500 kg
- comprimento total: 1550 mm
- comprimento dos braços: 1150 mm
- largura do braços: 540 mm
- largura individual do braço: 160 mm
- altura da alavanca: 1230 mm
- altura máx. de elevação: 115 mm
- área de armazenamento de paletes: 800x1200 longitudinalmente: 1805 mm
- raio de viragem: 1347 mm

3069 € 865,00 1 030690000



# Beta

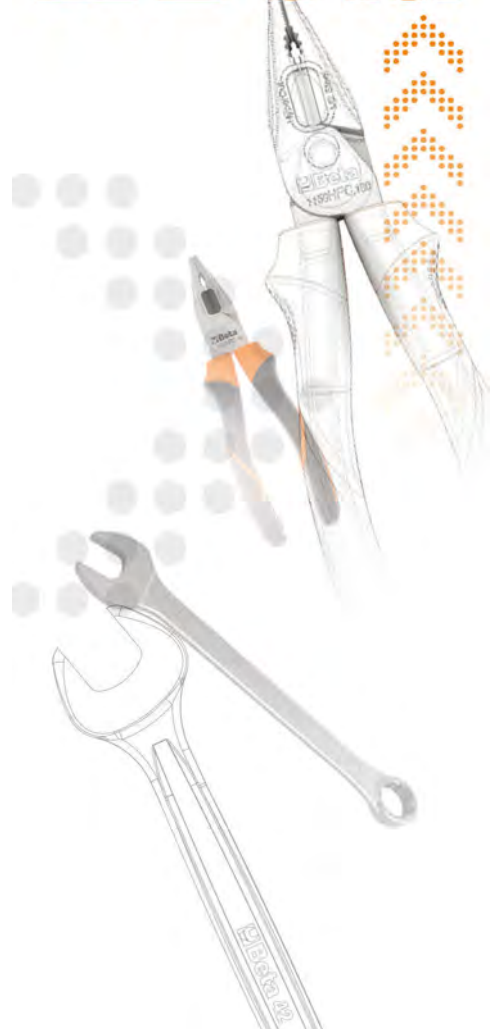





# FERRAMENTAS PARA MOTOCICLOS



A gama de ferramentas para motociclos da Beta inclui produtos concebidos especificamente para a indústria de motociclos. Os nossos produtos são atualizados regularmente.

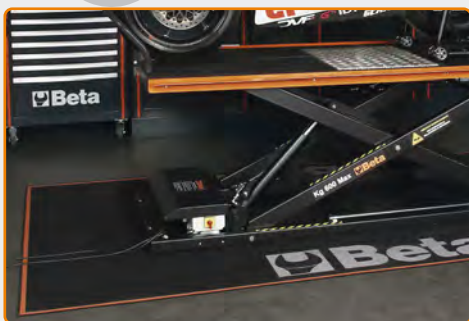

### 3040C

apoio traseiro para motocicletas, regulável

- Lacado preto mate
- 4 rodas em borracha termoplástica
- Inclui rolamentos em V, par
- Inclui rolamentos em L em borracha, par



3040C € 92,50 1 030400002

### 3040C/S1

rolamentos em V, par, para item 3040C



3040C/S1 € 14,70 1 030400503

### 3040C/S2

rolamentos em L em borracha, par, para item 3040C



3040C/S2 € 21,20 1 030400504

### 3041C

apoio frontal para motocicletas, regulável

- Lacado preto mate
- 4 rodas em borracha termoplástica
- Inclui rolamentos, par
- Inclui rolamentos cônicos, par



3041C € 86,50 1 030410002

### 3041C/12

rolamentos, par, para item 3041C



3041C/12 € 20,40 1 030410512

### 3041C/16

rolamentos cônicos, para item 3041C



3041C/16 € 14,00 1 030410516

### 3042C

apoio frontal para pino de direção de motocicletas

- Lacado preto mate
- 4 rodas em borracha termoplástica
- Inclui jogo de 8 pinos Ø 13 - 15 - 15.5 - 17 - 19 - 20 - 21 - 27



3042C € 156,00 1 030420002

### 3043C

apoio para motocicletas com braço à esquerda

- Lacado preto mate
- 4 rodas em borracha termoplástica



3043C € 114,00 1 030430002

### 3043C/ 41÷47

pino para ref. 3043C



	Ø mm	€		
3043C/41	21,5 ÷ 25,5	26,00	1	030430551
Ducati				
3043C/42	27,5	26,00	1	030430552
KTM - Triumph				
3043C/43	42,5	28,50	1	030430553
MV				
3043C/44	40,5	28,50	1	030430554
Ducati				
3043C/45	28,5	26,00	1	030430555
Honda				
3043C/47	53,5	33,50	1	030430557
BMW				

### 3047C

cavelete manual para motocicletas cross/enduro



3047C € 72,00 1 030470002

### 3048C

preguiça em alumínio



3048C € 72,00 1 030480002

### 3050/CC

Elevador manual para motocicletas Custom, Enduro, Cross, Scooter

inclui kit de suporte ajustável

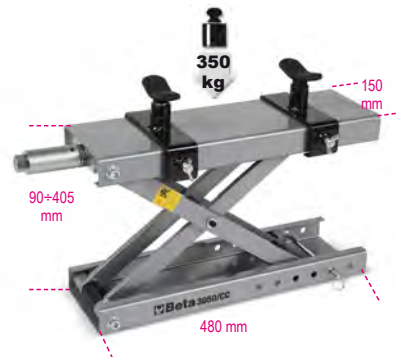

3050/CC € 185,00 1 030500012





## 3050/600

elevador para motocicletas electro-hidráulico, 600 kg

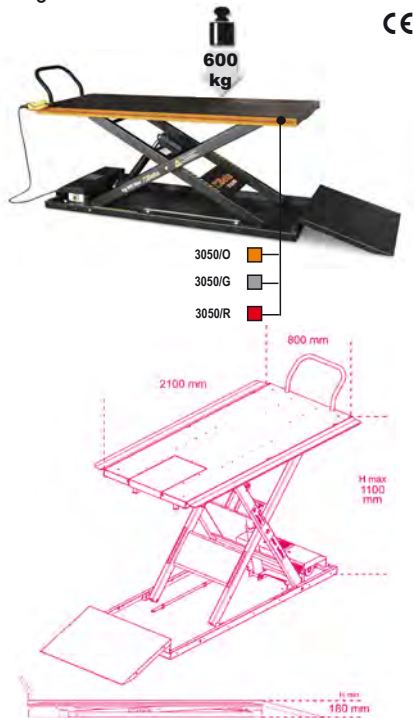

### Características técnicas

- Dispositivos de segurança elétricos, mecânicos e hidráulicos
- Capacidade: 600 kg
- Unidade electro-hidráulica integrada: 230V - 50 Hz
- Bomba hidráulica
- Velocidade de descida controlada
- Fusíveis de segurança para proteção em caso de corte dos cabos
- Painel de controlo com botão
- Certificado CE, aprovação TÜV

	L	L	H min	H Max	€		
	mm	mm	mm	mm			
3050/O	975	2100	185	1110	6.250,00	1	030500201
3050/G	975	2100	185	1110	6.250,00	1	030500202
3050/R	975	2100	185	1110	6.250,00	1	030500203

## 3050/KA

kit de extensão para elevador item 3050/600

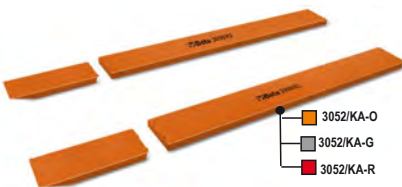

	A	B	€		
	mm	mm			
3050/KA-O	107,5	2100	1.250,00	1	030500221
3050/KA-G	107,5	2100	1.250,00	1	030500222
3050/KA-R	107,5	2100	1.250,00	1	030500223

## 3050/MS

bloqueio de roda para item 3050/600

permite o bloqueio da roda frontal do motociclo



	€		
3050/MS	710,00	1	030500032

## 3050/MV

grupo de rodas mecânico para elevador 3050/600



	€		
3050/MV	1.240,00	1	030500034

## 3050/LA

tampo de metal para item 3050/600

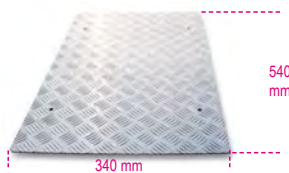

	€		
3050/LA	142,00	1	030500062

## 9562T1

tapete para oficina, 100X80 cm

particularmente adequado para utilização com BETA 3071 e 3071B

- borracha antiderrapante de limpeza fácil



	L	H	€		
	cm	cm			
9562T1	100	80	91,00	1	095620150

## 9562T3

tapete para oficina

Dimensões: 300x160 cm

- particularmente adequado para utilização sob motocicletas
- protege o chão de derrames de óleo e combustível, respeita o meio ambiente
- limpeza fácil, parte de trás antiderrapante em borracha



	L	H	€		
	cm	cm			
9562T3	300	160	360,00	1	095620300

## 3054

trolley para suporte central ou apoio traseiro de motocicletas com extensão para apoio lateral



	max kg	€		
3054	500	312,00	1	030540000

## 3055M

Bloqueio automático de motocicletas para carrinhas

Permite fixar a roda dianteira do motociclo



	€		
3055M	119,00	1	030550002

## 3057

rampa em alumínio para carga/descarga de motocicletas



	€		
3057	253,00	1	030570001

**Beta**  
50 Years in Motorsports



## 3070B

Equilibrador manual



- Permite equilibrar as rodas tanto nas oficinas como nas pistas de corrida;
- Equipado com rolamentos nível de bolha de nivelção e pesos ajustáveis para uma precisão exata;
- Vem com 2 cones para cubos;

3070B	€ 149,00	1	030700100
-------	----------	---	-----------

## 3070B/...



apoio para equilibrador 3070B



	Ø1	Ø2	L	€		
	mm	mm	mm			
3070B/10	30	10	410	26,50	1	030700101
3070B/12	30	12	415	31,00	1	030700102
3070B/14	40	14	415	38,00	1	030700103

## 3071A



alavanca desmontagem manual de pneus de motocicletas cross e enduro

- Permite a remoção fácil e rápida de pneus em pistas de corrida; estrutura ampla e robusta em aço galvanizado, proporciona firmeza na desmontagem do pneu. Pode ser instalada no apoio BETA 3071RS, para maior conveniência
- Características:
- Punho ergonômico em borracha, para segurar a alavanca de forma fácil e segura
  - Retentor de borracha com haste para bloqueio durante o transporte
  - Pode ser utilizada para instalar pneus cross e enduro, 17"÷ 21".

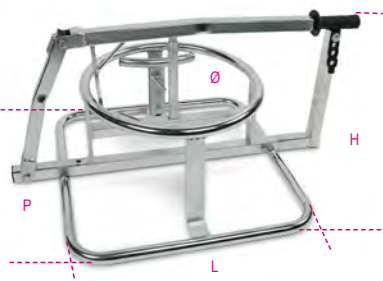

	L	H	P	Ø	€	
	mm	mm	mm	mm		
3071A	570	400	850	440	575,00	1 030710000

## 3071B



alavanca desmontagem manual de pneus de motocicletas mini bikes e mini dirt bikes

- Permite a remoção fácil e rápida de pneus em pistas de corrida; estrutura ampla e robusta em aço galvanizado, proporciona firmeza na desmontagem do pneu. Pode ser instalada no apoio BETA 3071RS, para maior conveniência
- Características:
- Punho ergonômico em borracha, para segurar a alavanca de forma fácil e segura
  - pode ser utilizada para instalar pneus mini bike e mini dirty bike.

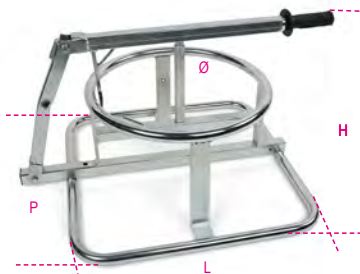

	L	H	P	Ø	€	
	mm	mm	mm	mm		
3071B	570	330	650	340	540,00	1 030710010

## 3071RS



apoio para BETA 3071A e alavanca de desmontagem 3071B

- Utilizado para elevar as alavancas de desmontagem BETA 3071A e 3071B, facilitando a remoção do pneu; estrutura em aço galvanizado, base quadrada para maior firmeza.
- Com 4 ganchos de fixação

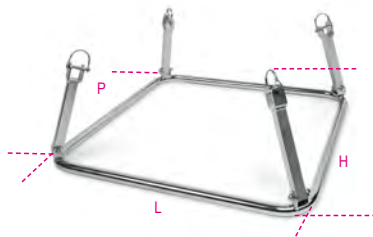

	L	H	P	€	
	mm	mm	mm		
3071RS	670	275	670	250,00	1 030710020

## 962C



ferros de desmonta, par, para motocicletas cross e enduro, mini bikes e mini dirty bikes para utilização em combinação com BETA 3071A e 3071B



	L	A	€	
	mm	mm		
962C	420	30	132,00	1 009620020

## 3072N



bancada de trabalho para desmontagem manual do amortecedor traseiro de motocicletas

- Permite a desmontagem do amortecedor traseiro de motocicletas de forma totalmente segura; através dos braços ajustáveis, é adequada para a maioria dos amortecedores traseiros; em alternativa, pode ser utilizado com a placa fornecida.
- anéis de bloqueio opcionais

### Características

- Adequada para utilização na maioria dos amortecedores traseiros de motocicletas
- Ajuste vertical em 8 posições
- 3 braços ajustáveis com retentores com ajuste vertical
- Placa de bloqueio do amortecedor
- Macaco pantógrafo
- Pés de borracha
- Pino de bloqueio do amortecedor

### Características técnicas:

- Extensão do macaco: máx. 130 mm
- Extensão do braço: máx. 55 mm
- Extensão do retentor: máx. 18 mm
- Impulso: máx. 1 t



	L	H	P	€	
	mm	mm	mm		
3072N	390	785	390	1.300,00	1 030720010

## 3073



ferramenta universal para substituição dos O-rings de suspensão para tubos de diâmetro 35 ÷ 48 mm



	€	
3073	99,00	1 030730001



### 30740

chave para suspensão eletrónica Ohlins



12"

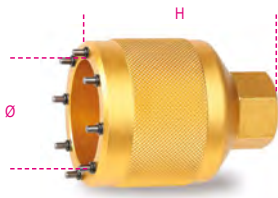

30740	H mm	Ø mm	€	1	030740001
	70,5	50,5	116,00		

### 30740/S

chave para suspensão Sachs para DUCATI Multistrada



12"



30740/S	H mm	Ø mm	€	1	030740002
	75	65	131,00		

### 30740/M

chave para suspensão Marzocchi para DUCATI 1199 e Hypermotard

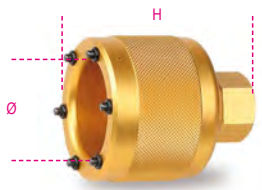

30740/M	H mm	Ø mm	€	1	030740003
	69	55	114,00		

### 30740/2

chave para suspensão octogonal Ohlins para motos DUCATI

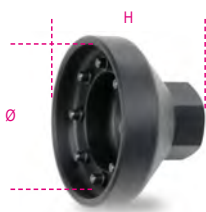

30740/2	H mm	Ø mm	€	1	030740004
	45	65	120,00		

### 3075B

chave bi-sextavada para eixo de roda



12"

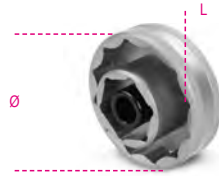

3075B 55	Ø mm	L mm	€	1	030750155
	55	70,7	82,50		

### 3075MV

Chave Bi-Sextavada para eixo de roda



12"

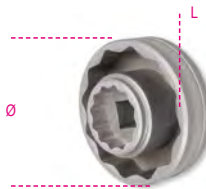

3075MV 56	Ø mm	L mm	€	1	030750156
	56	70,7	92,50		

### 3075/CM

chave sextavada múltipla para eixo da roda



3075/CM	€	1	030750212
12-14-17-19-22-24 mm	46,50		

### 3075/K10

kit com chave universal com cabeça intercambiável e 10 bits, para jantes



Tamanhos: 5.2 - 5.4 - 5.6 - 5.8 - 6.0 - 6.2 - 6.4 - 6.6 - 6.8 - 7.0



3075/K10	€	1	030750410
	62,00		

### 3080/C15

Kit abertura e cravagem de correntes



Ø 3-4-5 mm e kit Regina



3080/C15	€	1	030800015
420x185x60 mm	411,00		

### 3080R/CS3

kit com 3 punhos de substituição para corrente 3080 / C15



Ø 3-4-5 mm



3080R/CS3	€	1	030800503
	63,50		

### 3081

ferramenta para cravar



Robusta e articulada, facilmente transportável. Adequada para correntes 415, 420, 428, 520, 525, 530, 532



3081	€	1	030810010
	51,50		

### 3085

ferramenta para recuar êmbolos dos travões



Adequada para motocicletas e scooters



3085	€	1	030850010
	114,00		

**3091**  
extrator de rosca interna  
para volante magnético



	M	€	🔧	📦
3091/25	27x1,0	25,50	1	030910025
3091/30	28x1,0	25,50	1	030910030
3091/40	30x1,0	34,00	1	030910040
3091/45	30x1,5	34,00	1	030910045
3091/50	32x1,5	37,00	1	030910050
3091/60	33x1,5	38,50	1	030910060
3091/70	35x1,0	54,50	1	030910070
3091/75	35x1,5	54,50	1	030910075
3091/80	38x1,5	59,50	1	030910080

**3092**  
extrator de rosca externa  
para volante magnético



	M	€	🔧	📦
3092/25	27x1,0	15,40	1	030920025
3092/50	26-28x1,0	15,50	1	030920050
3092/60	28x1,5	15,30	1	030920060

**3093/E**  
ferramentas de bloqueio para prato de  
embraiagem, volante magnético e polias



	€	🔧	📦
3093/E	42,00	1	030930100

**3093/U**  
extrator múltiplo para volante magnético



	€	🔧	📦
3093/U	40,50	1	030930050
M10x1.25R			
M14x1.5R			
M16x1.5R			
M18x1.5R			
M24x1.0R			
M27x1.0L			

**3095**  
apoio de bancada para motores de motocicletas



suportes de montagem ajustáveis, para um trabalho  
conveniente e sem esforço em motores de motocicletas



	H	P	L	L1	€	🔧	📦
3095	360	460	640	460	675,00	1	030950001

**3099E**  
revestimento de exterior para motocicletas,  
impermeável (água e poeiras)



proteção da pintura contra riscos, poeiras e luz solar



Tamanho "M" recomendado para motocicletas desportivas e  
scooters de tamanho médio  
Tamanho "L" recomendado para motocicletas maxi enduro e  
crossover

	M	€	🔧	📦
3099E/M	M	95,50	1	030990102
3099E/L	L	118,00	1	030990103

**3099T**  
revestimento de interior para motocicletas, em  
tecido extensível



proteção da pintura contra riscos, poeiras e luz solar



Tamanho "M" recomendado para motocicletas desportivas e  
scooters de tamanho médio  
Tamanho "L" recomendado para motocicletas maxi enduro e  
crossover  
Tamanho "XL" motocicletas super touring

	Tg	€	🔧	📦
3099T/M	M	83,00	1	030990202
3099T/L	L	102,00	1	030990203
3099T/XL	XL	123,00	1	030990204



**Beta**

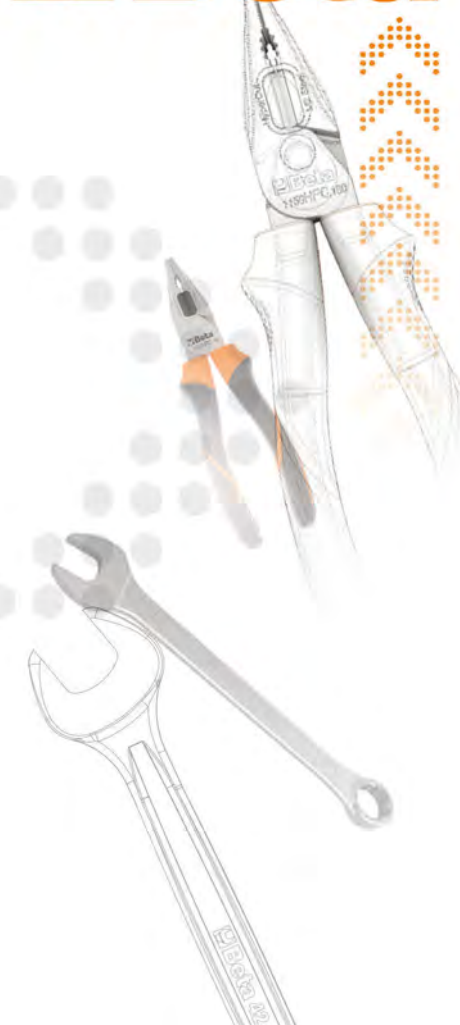





# FERRAMENTAS PARA BICICLETAS



Beta sempre esteve envolvida com o ciclismo. Este “Especial Ferramentas para Bicletas”, destinado aos profissionais do ciclismo, inclui uma seleção de produtos especialmente desenvolvidos para manutenção de bicicletas e e-bikes.



Tour de France winner 2020, 2021 e 2024  
Giro d'Italia winner 2024



Partnership 2024



Official contributor  
POLTI KOMETA cycling



Partnership 2024





## 3910

elevador E-Bike

- Capacidade de carga máx.: 40 kg
- Altura máx. do suporte de movimento central: 135 cm
- Base de rodas integrada
- Inovador sistema de bloqueio do eixo
- Fornecido com adaptadores para a maioria dos garfos
- Fornecido com adaptador de garfo sem eixo
- Totalmente dobrável e de fácil transporte
- Peso: 48kg

CE

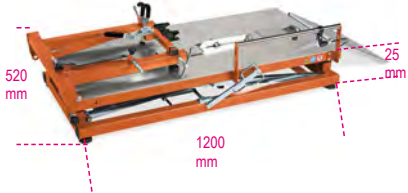

3910 € 4.110,00 1 039100010

## 3912TP

bancada de trabalho TOP para manutenção de bicicletas

- Com suporte para movimentação central, com pino de segurança
- Gaveta de ferramentas com guias de rolamentos de esfera (490x365x90 mm)
- Suporte para roda incorporado
- Sistema inovador de bloqueio através do eixo



3912TP € 1.710,00 1 039120050

## 3912PP

bancada de trabalho PRO para manutenção de bicicletas

- Com suporte para movimentação central, com pino de segurança
- Suporte para roda incorporado
- Sistema inovador de bloqueio através do eixo



3912PP € 985,00 1 039120150

## 3912TP/A

adaptador para garfos com eixo passante

Para bancadas de trabalho 3912TP, 3912PP e 3910



L mm 39 Ø mm 30 Ø1 mm 5 € 22,70 1 039120052

## 3912TP/C

adaptador universal para garfos com eixo passante, aperto com chave de caixa sextavada

Para bancadas de trabalho 3912TP, 3912PP e 3910



L mm 29 Ø mm 30 € 22,70 1 039120054

## 3912TP/FOX

adaptador para garfos FOX®

Para bancadas de trabalho 3912TP, 3912PP e 3910



L mm 38 € 22,70 1 039120058

## 3912TP/QRE

pino adaptador para garfos sem eixo passante

Para bancadas de trabalho 3912TP, 3912PP e 3910



L mm 108 € 37,50 1 039120064

## 3912TP/ROAD

adaptador para garfos de estrada

Para bancadas de trabalho 3912TP, 3912PP e 3910



L mm 33 Ø mm 35 € 25,50 1 039120060

## 3912TP/RS

adaptador para garfos com eixo passante ROCKSHOX®

Para bancadas de trabalho 3912TP, 3912PP e 3910



L mm 35 Ø mm 30 € 22,70 1 039120056

## 3912TP/ST

adaptador para garfos SUNTOUR

Para bancadas de trabalho 3912TP, 3912PP e 3910



L mm 31 Ø mm 30 Ø1 mm 18 € 25,50 1 039120062



## 3916MMP

grampo unilateral para reparação de bicicletas

- Rotação 360°
- Capacidade de carga: 25 kg
- Tabuleiro em plástico



3916MMP € 840,00 1 039160150

## 3918MML

grampo unilateral, leve, dobrável

- Grampo rotativo a 360°
- Capacidade: 15 kg
- Altura máx. do grampo: 150 cm



3918MML € 342,00 1 039180010

## 3921

Calibrador do suporte de mudanças

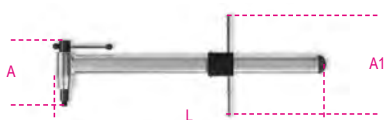

L mm 440 A mm 115 A1 mm 165 € 119,00 1 039210010

## 3923

Grampo para corte de espigões do selim até 80mm e tubos 1" ÷ 1.1/2"



L mm 160 A1 max mm 80 Ø max mm 45 € 56,50 1 039230010

## 3927

Grampo para guidador



3927 L mm 365 € 34,00 1 039270010

## 3932U

Ferramenta para correntes compatível com correntes de 5 a 11 velocidades



L mm 164 L1 mm 115 € 62,50 1 039320011

## 3935

Ferramenta de verificação do desgaste das correntes



L mm 120 € 10,70 1 039350010

## 3937

Alicate para elos de correntes



L mm 170 € 27,50 1 039370010

## 3948

Extrator do crenque/braço do pedal

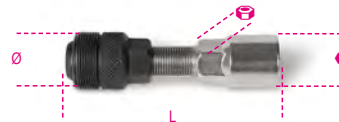

mm L mm Ø mm mm € 14 79 20 15 21,30 1 039480015

## 3952

Chave de cones simples



mm	L mm	S1 mm	€		
13	205	2	27,50	2	039520013
14	205	2	27,50	2	039520014
15	205	2	27,50	2	039520015
16	205	2	27,50	2	039520016
17	205	2	27,50	2	039520017
18	205	2	27,50	2	039520018
19	205	2	27,50	2	039520019
20	205	2	28,00	1	039520020
21	205	2	28,00	1	039520021
22	205	2	28,00	1	039520022
24	205	2	29,00	1	039520024



	€		
3952/S7 13-14-15-16 17-18-19 mm	191,00	1	039520207
3952/S11 13-14-15-16 17-18-19-20-21-22-24 mm	304,00	1	039520211

## 3953

Chave de boca para pedais



mm L mm € 15 401 42,50 1 039530015

## 3955

Chave de bocas para caixas de direção universais



mm	L mm	€		
30x32	292	39,50	1	039550108
32x36	319	43,50	1	039550114



### 3961 3,2

Chave para raios, preta, 3.2 mm



mm 3,2 € 15,50 1 039610032

### 3961 3,3

Chave para raios, verde, 3.3 mm



mm 3,3 € 15,50 1 039610033

### 3961 3,5

Chave para raios, vermelha, 3.5 mm



mm 3,5 € 15,50 1 039610035

### 3961U

Chave múltipla para raios, 3.2 - 4.0 mm



mm 3,2 - 4,0 € 25,50 1 039610100

### 3962SH

Chave dupla para raios Shimano



L mm 132 A1 mm 4,3 A2 mm 4,4 € 19,70 1 039620010

### 3962MV

Chave dupla para raios Mavic



L mm 135 A1 mm 4,3 A2 mm 8,4 € 20,40 1 039620020

### 3963P

Chave especial para raios planos



L mm 129 € 9,30 1 039630010

### 3964

Chave especial para cabeça do raio



L mm 170 L1 mm 89 € 23,00 1 039640010

### 3965

Verificador de alinhamento das rodas,  $\varnothing 20'' \div 29''$



L mm 680 € 113,00 1 039650010

### 3965C

Suporte para alinhar rodas

- Adequado para rodas  $\varnothing 20'' \div 29''$
- Através de adaptador para cubo do eixo, 10  $\div$  20mm

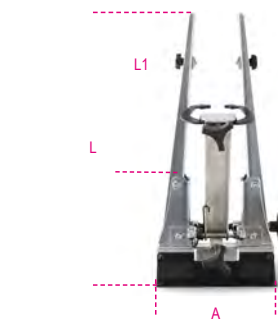

L mm 500 L1 mm 380 A mm 285 € 454,00 1 039650110

### 3967

Ferramenta de bloqueio da cremalheira

- Adequado para cremalheiras até 11 carretos
- Punho em PVC bicomponente
- Também adequado para cremalheiras fixas



L mm 289 € 62,00 1 039670010

### 3969

Alavanca metálica de pneus



L mm 200 A mm 15,6 € 11,30 1 039690010

### 3969K3

Kit de 3 alavancas de plástico, para pneus



L mm 113 € 6,30 1 039690130

### 3971

Chave para parafusos de plástico Shimano

- Adequado para Shimano Hollowtech II cranksets



Nº tacche 8 mm 8 € 13,80 1 039710010

### 3972

Chave de extração do eixo de tração

- Adequado para Shimano® Hollowtech II, Campagnolo® Ultra-torque, FSA®, SRAM®



L mm 252 € 26,50 1 039720010

### 3973PF

Extrator de rolamentos Press-Fit

- Adequada para  $\varnothing$  interiores 24 mm e 30 mm



L mm 240 € 35,50 1 039730001

### 3973/1

Chave de extração do eixo de tração com 16 entalhes

- Adequado para Shimano® XTR BB93, Dura-Ace® BB9000

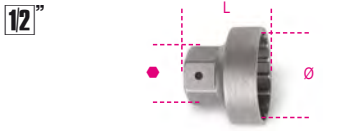

12"  $\varnothing$  mm 39 mm 24 L mm 34 € 22,80 1 039730010

### 3973/2

Chave de extração do eixo de tração com 16 entalhes

• Adequado para Shimano® BBR60 (Ultegra® 11 speeds)

12"



Ø mm	mm	L mm	€	1	039730020
41	24	35	22,80		

### 3973/3

Chave de extração do eixo de tração com 16 entalhes

• Adequado para Shimano® Hollowtech II, Campagnolo® Ultra-torque, FSA®, SRAM®

12"



Ø int. mm	mm	L mm	€	1	039730030
46	24	53,5	22,80		

### 3973/4

Chave extração do eixo de tração com 20 entalhes, com pino central, niquelada

• Adequado para Shimano e ISIS

12"

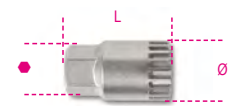

Ø mm	L mm	mm	€	1	039730040
31,5	55	24	14,40		

### 3975

pressa de montagem de rolamentos

• adequada para montagem de caixas de direção 1", 1.1/8", 1.1/4", 1.1/2" e 2"

NB: Não deve ser utilizada com caixas de direção "zero stack"



L mm	Ø mm	€	1	039750010
360	16x1	301,00		

### 3984/1

Chave de extração de cremalheira BMX, 4 pinos

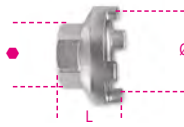

Ø mm	L mm	mm	€	1	039840010
35	25,5	24	16,80		

### 3984/2

Chave de extração de cremalheira Shimano



Ø mm	L mm	mm	€	1	039840020
22,8	26	24	10,70		

### 3984/3

Chave de extração de cremalheira Shimano, cassete com pino guia

12"

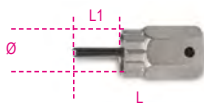

Ø mm	L mm	L1 mm	€	1	039840030
23,5	65	25	18,30		

### 3984/4

Chave de extração de cremalheira Campagnolo, com pino guia

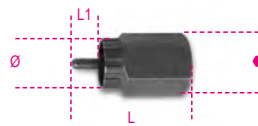

Ø mm	L mm	L1 mm	mm	€	1	039840040
23	51	13	24	23,90		

### 3984/5

Chave de extração de cremalheira, 2 pinos

12"



Ø mm	L mm	mm	€	1	039840050
18,5	38	21	16,80		

### 3984/6

Chave de extração de cremalheira, 4 pinos

12"



Ø mm	L mm	mm	€	1	039840060
19,5	36	21	16,80		

### 3991

Alavanca para os freios do disco de travão



L mm	A mm	α	€	1	039910010
222	36	7°	40,00		

### 3992

Alinhador de discos de travão



L mm	S mm	A mm	A1 mm	€	1	039920010
234	4	55	2,2	30,00		

### 2115PI/BIKE-HOME



2115PI/BIKE-HOME	354
------------------	-----

### M400



M400	554
MV400	554

### M401



M401	554
MV401	554

### MM400



MM400	558
MMV400	558

### MM401



MM401	559
MMV401	559





# FERRAMENTAS ISOLADAS

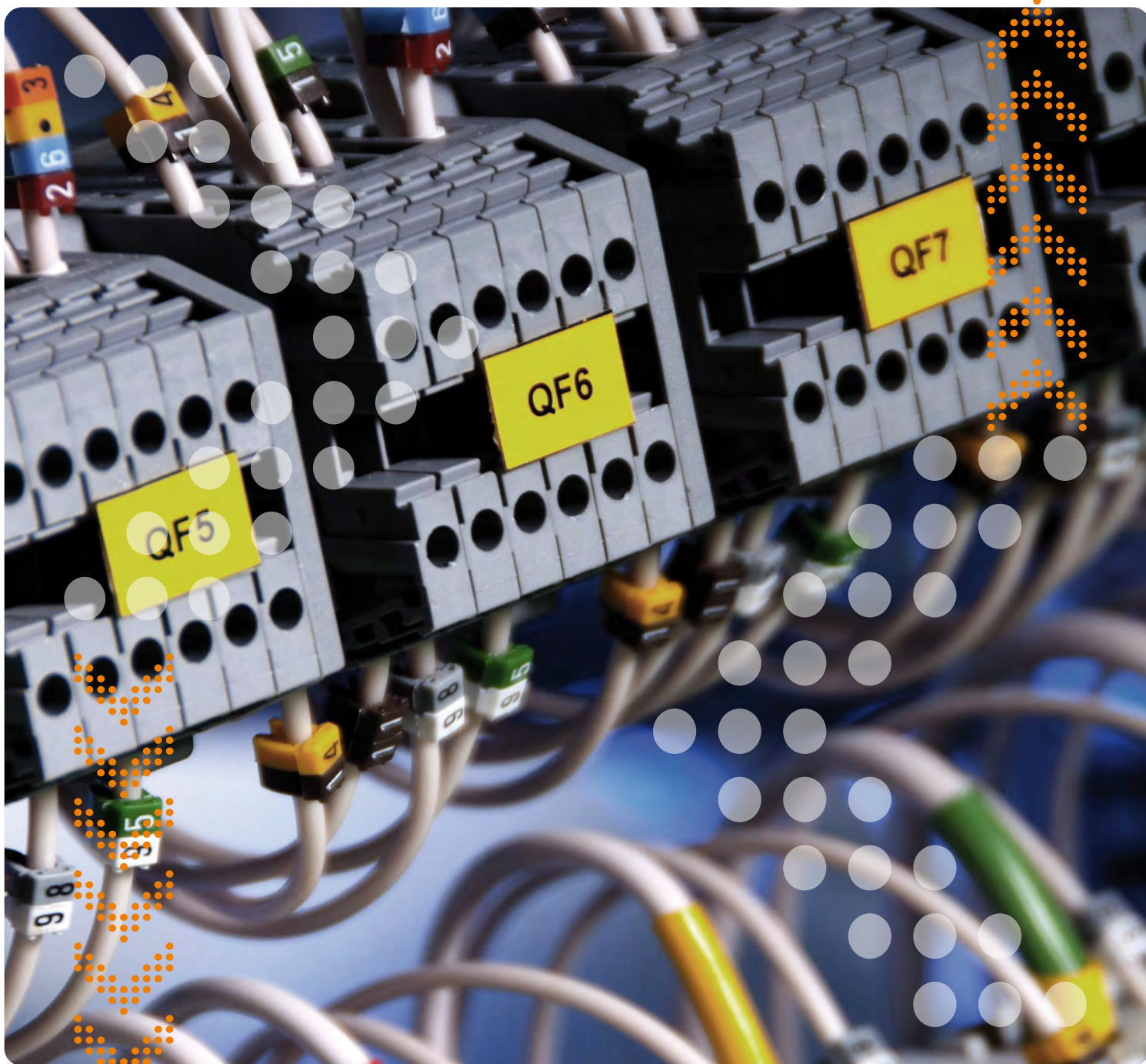

As ferramentas isoladas Beta Utensili destinam-se a garantir a segurança nos trabalhos de instalação e manutenção eléctrica.

Todas as ferramentas isoladas possibilitam trabalhar em sistemas de corrente alternada até 1000V e até 1500V em corrente contínua.

Para fornecer a melhor qualidade nos padrões de desempenho e possuir a adequada conformidade com a norma EN 60900, cada ferramenta é submetida a testes rigorosos: resistência a escorregamento dos punhos, propagação de chamas e teste de alta tensão (10000V).

Para jogos e módulos de ferramentas, consultar as respectivas secções.

Todas as ferramentas isoladas Beta são fabricadas de acordo com as especificações da EN60900 e aprovadas pelas principais instituições de certificação europeias.



Istituto Italiano del Marchio di Qualità - I



Verband der Elektrotechnik  
Elektronik Informationstechnik - D



## TESTES DE SEGURANÇA: testadas a 10.000 V para trabalhar em instalações elétricas de 1.000 V.

As ferramentas de elevado isolamento da Beta são testadas peça a peça a 10 kV, com o objetivo de proporcionar uma qualidade incomparável aos instrumentos de trabalho necessários para garantir padrões de segurança extremamente elevados: estas possibilitam o trabalho com voltagens até 1.000 V a.c. (1.500 V d.c.).

### NORMAS DE SEGURANÇA:

Embora sejam realizados testes extremamente rigorosos durante a produção, antes de utilizar uma ferramenta, o operador deve sempre verificar o punho isolante quanto a fissuras, modificações ou danos. Manter as propriedades dielétricas inalteradas ao longo do tempo está intimamente ligado ao stress mecânico, químico ou térmico ao qual a ferramenta pode estar sujeita. Caso o isolamento fique danificado, a ferramenta não pode ser considerada segura para utilização em instalações vivas. Utilize sempre óculos de proteção e luvas isoladas.

## TESTES REALIZADOS DURANTE A PRODUÇÃO



### Teste visual 100%:

Todos os acabamentos de superfície das ferramentas devem estar livres de defeitos visíveis externamente.



### Teste de colisão:

Após 2 horas a -25 °C, a ferramenta é atingida três vezes (com um peso específico, conforme previsto na norma); o punho isolante não deve apresentar sinais de danos.



### Teste de penetração:

Aplica-se um peso de 2 kg ao punho da ferramenta a +70 °C durante duas horas. Posteriormente, é aplicada uma voltagem de 5 kV na área sujeita a pressão mecânica durante 3 minutos. Não deve apresentar qualquer sinal de passagem de corrente.

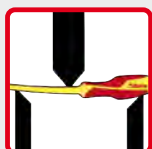

### Ensaio mecânico:

As ferramentas devem atender aos requisitos de desempenho mecânico previstos nas normas ISO relevantes.



### Teste de propagação da chama:

Uma chama é direcionada para a ferramenta durante 10 segundos; durante os 20 segundos seguintes a chama não deve exceder uma altura de 120 mm.



### Teste dimensional:

Todas as dimensões das ferramentas devem atender às especificações do projeto.

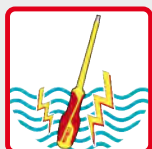

### Teste de isolamento elétrico:

Após imersão em água durante 24 horas, a ferramenta é submetida a uma voltagem de 10 kV durante 3 minutos. A dissipação da corrente não deve exceder os valores previstos na norma.



500N

### Teste de aderência:

Após 168 horas a +70 °C, a ferramenta é submetida a uma carga de 500 N para verificar se o punho não escorrega.



### Teste de indelebilidade da marcação:

Após o teste de atrito com álcool isopropílico, as marcações devem permanecer legíveis.



chaves de bocas simples isoladas



EN 60900

mm	L mm	€		
*6	90	35,00	1	000520106
*7	96	35,00	1	000520107
*8	100	35,00	1	000520108
*9	108	35,00	1	000520109
*10	110	35,00	1	000520110
*11	120	35,00	1	000520111
*12	132	37,50	1	000520112
*13	140	39,50	1	000520113
*14	146	40,50	1	000520114
*15	166	42,00	1	000520115
*16	156	45,50	1	000520116
*17	168	45,50	1	000520117
*18	170	47,00	1	000520118
*19	176	47,00	1	000520119
21	190	51,50	1	000520121
*22	200	51,50	1	000520122
*24	225	55,50	1	000520124
*27	210	72,50	1	000520127
*30	240	76,00	1	000520130
*32	240	77,50	1	000520132

chaves de luneta



EN 60900

mm	L mm	€		
*6	150	45,00	1	000890106
*7	155	45,00	1	000890107
*8	155	45,00	1	000890108
*9	160	45,00	1	000890109
*10	170	45,00	1	000890110
*11	180	45,00	1	000890111
*12	190	49,00	1	000890112
*13	195	52,50	1	000890113
*14	200	55,50	1	000890114
*15	210	56,50	1	000890115
*16	216	60,00	1	000890116
*17	218	60,00	1	000890117
*18	236	64,50	1	000890118
*19	240	64,50	1	000890119
21	250	73,50	1	000890121
*22	255	73,50	1	000890122
*24	280	83,50	1	000890124
*27	300	88,50	1	000890127
*30	320	104,00	1	000890130
*32	340	106,00	1	000890132

chave de abertura variável com escala



EN 60900

L mm	A max	€		
200	28	90,00	1	001100520
250	30	104,00	1	001100525
300	30	152,00	1	001100530

## 606MQ/50

chave dinâmométrica com desarme sonoro e com roquete reversível



EN 60900  
UNI EN 26789  
ISO 6789

Nm	Kgfm	lbf.ft	A mm	L mm	g
5÷50	0,5÷5	4÷40	90	375	1130

606MQ/50	€	1	006060705
	870,00		

## 850MQ

porta bits magnético, isolado, com punho de 2 componentes



IMQ CSV  
EN 60900

L mm	L1 mm	D mm	€	1	008500910
233	125	12.5	26,50		

## 910MQ/B

chaves de caixa bi-sextavadas



EN 60900

Ø mm	L mm	Ø1 mm	Ø mm	€	1	009100616
6	45	14	24	32,00		
7	45	15	24	32,00		
*8	45	16	24	32,00		
*9	45	17	24	32,00		
*10	45	19	24	32,00		
*11	45	20	24	32,00		
*12	45	24	24	32,00		
*13	45	24	24	32,00		
*14	45	25	24	32,00		
*15	45	27	24	33,50		
*16	45	27,5	24	33,50		
*17	45	30	24	34,50		
*18	45	31	24	34,50		
*19	45	32	24	34,50		

## 910MQ/PE

chaves de caixa para parafusos sextavados



EN 60900

mm	Ø mm	L mm	€	1	009100604
4	24	100	36,00		
*5	24,5	100	36,00		
*6	25,0	100	36,00		
*8	25,0	100	36,00		
10	25,5	100	37,50		

## 910MQ/TX

chaves de caixa de perfil Torx®



EN 60900

Ø mm	L mm	L1 mm	€	1	009100641
T15	23	116	61	45,50	
T20	24,5	116	65	45,50	
T25	24,5	116	65	45,50	
T27	24,5	116	65	45,50	
T30	24,5	116	65	46,50	
T40	24,5	116	65	47,00	

## 910MQ/XZN

chaves de caixa de perfil XZN®



EN 60900

Ø mm	L mm	L1 mm	€	1	009100658
M8	24	106	57	42,50	
M10	24	106	57	44,00	

## 910MQ/PT

extensões com quadra fêmea de 3/8"



EN 60900

Nm	L mm	L1 mm	€	1	009100801
12	80	35,5	240,00		

## 910MQ/21

extensão quadra 3/8"



EN 60900

L mm	Ø mm	€	1	009100804
140	13,4	58,00		

## 910MQ/22

extensão quadra 3/8"



EN 60900

L mm	Ø mm	€	1	009100805
265	13,4	63,50		

## 910MQ/T

punho em T, encabadouro 3/8"



EN 60900

L mm	L1 mm	€	1	009100807
200	165	69,00		

## 910MQ/55

roquete reversível quadra de 3/8"



EN 60900

L mm	D mm	A mm	€	1	009100808
203	41	67	197,00		

## 910MQ/C16

8 chaves de caixa bisextavadas, 4 chaves de caixa sextavadas com ponta macho e 4 acessórios



EN 60900

910MQ/C16	€	1	009100917
	860,00		

○ 910MQ/B	8 - 10 - 11 - 12 - 13 - 14 - 17 - 19 mm
○ 910MQ/PE	4 - 5 - 6 - 8 mm
910MQ/21	125 mm
910MQ/22	250 mm
910MQ/T	
910MQ/55	

## 914MQ/A

chaves de caixa sextavadas, quadra fêmea 3/8", em tecnopolímero especial à base de poliamida

Especialmente desenhada para baterias de carros híbridos e elétricos

Para utilização com chaves dinâmométricas



EN 60900

Ø mm	Ø mm	L mm	Ø1 mm	€		
8	17,5	45	20	16,70	2	009140008
10	20,5	45	20	16,70	2	009140010
13	24	45	20	16,70	2	009140013
17	30	45	22	16,70	2	009140017



EN 60900

914MQ-A/S4	€		
8-10-13-17 mm	67,00	1	009140054

## 920MQ/A

chaves de caixa bocas hexagonais



EN 60900

Ø mm	Ø mm	L mm	Ø1 mm	€		
8	21,5	57	27,5	32,00	1	009200238
9	21,5	57	27,5	32,00	1	009200239
10	21,5	57	27,5	32,00	1	009200240
11	21,5	57	27,5	32,00	1	009200241
12	23,0	57	27,5	32,00	1	009200242
13	23,0	57	27,5	32,00	1	009200243
14	23,0	57	27,5	33,00	1	009200244
16	23,0	57	27,5	33,50	1	009200246
17	30,0	57	27,5	33,50	1	009200247
18	32,0	57	27,5	34,50	1	009200248
19	32,2	57	27,5	34,50	1	009200249
20	32,0	57	27,5	39,00	1	009200250
21	34,0	57	27,5	39,00	1	009200251
22	36,0	57	27,5	39,00	1	009200252
24	39,0	57	27,5	40,00	1	009200254
27	42,0	57	27,5	40,50	1	009200257
30	44,0	57	27,5	42,00	1	009200260
32	48,0	57	27,5	43,00	1	009200262

## 920MQ/PE

chaves de caixa para parafusos sextavados



EN 60900

mm	D mm	L mm	L1 mm	€		
4	28,5	94,50	10,5	54,00	1	009200264
*5	28,5	94,5	10,5	54,00	1	009200265
*6	28,5	94,5	10,5	54,00	1	009200266
*8	28,5	94,5	10,5	54,00	1	009200268
10	28,5	94,5	10,5	56,00	1	009200267
12	28,5	94,5	10,5	56,00	1	009200269

## 920MQ/21

extensão com quadras macho e fêmea de 1/2"



EN 60900

L mm	Ø mm	€		
135	28	62,00	1	009200804

## 920MQ/22

extensão com quadras macho e fêmea de 1/2"



EN 60900

L mm	D mm	€		
264	30	70,00	1	009200805

## 920MQ/T

punho em T com quadra macho de 1/2"



EN 60900

L mm	L1 mm	€		
200	163	73,50	1	009200807

## 920MQ/55A

roquete reversível com quadra macho de 1/2" com sistema de bloqueio



EN 60900

L mm	D mm	A mm	€		
240	50	89	263,00	1	009200809

## 920MQ/C16

9 chaves de caixa sextavadas, 3 pontas para parafusos sextavados e 4 acessórios



EN 60900

920MQ/C16	€		
	1.010,00	1	009200917

920MQ/A	8 - 10 - 12 - 13 - 14 - 17 - 19 - 22 - 24 mm
920MQ/PE	5 - 6 - 8 mm
920MQ/21	135 mm
920MQ/22	264 mm
920MQ/55A	
920MQ/T	
420x280x60 mm - 5,2 kg	

## 943MQ

chaves de caixa com punho boca hexagonal



EN 60900

Ø mm	L mm	L1 mm	D mm	€		
5,5	233	125	12,2	20,90	1	009430235
6	233	125	12,5	20,90	1	009430236
7	240	125	14,3	22,20	1	009430237
8	240	125	15,3	22,80	1	009430238
10	252	125	17,3	23,60	1	009430240
13	252	125	21,3	26,00	1	009430243

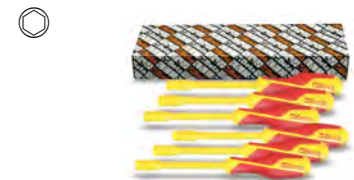

943MQ/S6	€		
5,5-6-7-8-10-13 mm	137,00	1	009430250

## 951MQ

chaves macho hexagonal com punho em T



EN 60900

mm	L mm	L1 mm	€		
3	120	105	52,50	1	009510703
*4	165	105	54,00	1	009510704
*5	170	105	54,00	1	009510705
*6	168	105	54,00	1	009510706
*8	165	105	55,00	1	009510708
10	200	105	57,00	1	009510710



### 993MQ

pinça com pontas curvas estriadas



EN 60900

L mm	€	1	009930040
147	44,00		

### 994MQ

pinça com pontas curvas estriadas



EN 60900

L mm	€	1	009940040
145	43,00		

### 1010MQ

alicates de pontas longas redondas



EN 60900

L mm	L1 mm	€	1	010100096
160	51,5	53,00		

### 1048MQ

Alicate ajustável, charneira fechada, isolado acabamento cromado

• Acabamento cromado



EN60900

L mm	A max mm	L1 mm	€	1	010480315
250	48	39	78,00		

### 1082MQ

alicates de corte diagonal



EN 60900

L mm	L1 mm	€	1	010820094
140	20	52,50		
160	22	55,00		

### 1084MQ

alicates de corte de diagonal para serviços pesados



EN 60900

L mm	L1 mm	€	1	010840100
200	26	69,00		

### 1088MQ

alicates de corte frontal



EN 60900

L mm	L1 mm	€	1	010880096
160	7	65,50		

### 1128MQ

tesoura de electricista, lâminas em aço inox, com microdentes



IEC60900

L mm	L1 mm	€	1	011280101
145	45	54,50		

### 1132MQ

alicate para cortar cabos de cobre e alumínio, com punhos isolados



EN 60900

L mm	€	1	011320193
230	101,00		

### 1142MQ

alicate de descarnar fio



EN 60900

L mm	€	1	011420096
160	58,00		

### 1150MQ

alicates universais em cromado brilhante



EN 60900

L mm	L1 mm	€	1	011500496
160	37	49,50		
180	39	54,50		
200	43	57,00		
220	46	62,50		

### 1162MQ

alicates de pontas extra-longas chatas



EN 60900

L mm	L1 mm	€	1	011620096
160	56	54,00		
200	76	57,00		

### 1164MQ

alicate de pontas curvas chatas extra-longas



L mm	L1 mm	€	1	011640096
160	54	56,00		
200	76	59,00		

### 1166MQ

alicates de pontas semi-redondas extra-longas



EN 60900

L mm	L1 mm	€	1	011660096
160	56	54,00		
200	76	57,00		

### 1168MQ

alicates de pontas curvas semi-redondas extra-longas



EN 60900

L mm	L1 mm	mm	€		
160	50	1,6	56,00	1	011680096
200	70	1,6	59,00	1	011680100

### 1169MQ/D2

Jogo de alicates, alicate universal (1 und.) e alicate de corte diagonal (1 und.)



1000 V

1169MQ/D2	€		
1150MQ 180 mm	110,00	1	011690152
1082MQ 160 mm			

### 1272MQF

chaves para parafusos de perfil Phillips®

Slim

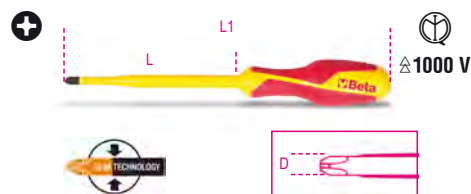

EN60900

PHxDxL mm	L1 mm	€		
1x4,5x80	180	15,80	3	012720609
2x6x100	208	17,80	3	012720618

### 1272MQ

chaves para parafusos de perfil Phillips®



EN 60900

PHxDxL mm	L1 mm	€		
0x3x60	160	10,60	3	012720703
1x4,5x80	188	13,00	3	012720709
2x6x100	219	14,80	3	012720718
3x8x150	277	19,20	2	012720724
4x10x200	327	22,80	2	012720727



1272MQ/S5	€		
PH0x3x60-PH1x4,5x80 PH2x6x100-PH3x8x150 PH4x10x200 mm	80,50	1	012720751

### 1273MQF/D...

jogo de 6 chaves para parafusos estreitas



1273MQF/D4	€		
1272MQF 1x4,5x80-2x6x100 mm 1274MQF 0,6x3,5x100-1x5,5x125 mm	63,00	1	012730604

1273MQF/D6	€		
1272MQF 1x4,5x80-2x6x100 mm 1274MQF 0,6x3,5x100-1x4,5x100 1x5,5x125-1,2x6,5x150 mm	97,00	1	012730606

### 1273MQ/D6

jogo de 6 chaves de fenda



1273MQ/D6	€		
1274MQ 0,5x3x100-0,8x4x100 1,0x5,5x125 mm 1272MQ PH0x3x60 -PH1x4,5x80 PH2x6x100 mm	76,00	1	012730851

### 1274MQF

chaves para parafusos de perfil de fenda sem cabeça

Slim

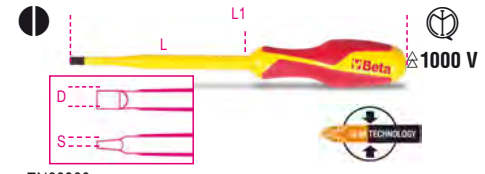

EN60900

SxDxL mm	L1 mm	€		
0,6x3,5x100	200	13,50	3	012740603
1x4,5x100	200	15,00	3	012740606
1x5,5x125	225	15,90	3	012740609
1,2x6,5x150	258	19,00	3	012740612

### 1274MQ

chaves para parafusos de perfil de fenda sem cabeça

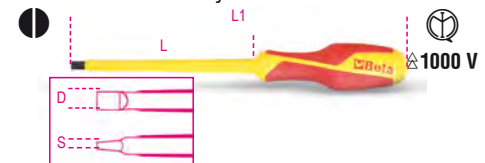

EN 60900

SxDxL mm	L1 mm	€		
0,4x2,5x75	175	10,30	3	012740700
0,5x3x100	200	10,80	3	012740703
0,8x4x100	208	12,80	3	012740706
1x5,5x125	233	13,60	3	012740709
1,2x6,5x150	269	16,50	3	012740712
1,2x8x175	302	19,20	2	012740715
1,6x10x200	327	22,70	2	012740718



1274MQ/S6	€		
0,5x3x100-0,8x4x100 1x5,5x125-1,2x6,5x150 1,2x8x175-1,6x10x200 mm	95,50	1	012740751

### 1275MQ/C

Chave combinada para parafusos de fenda + cabeça em cruz PH

espessura reduzida

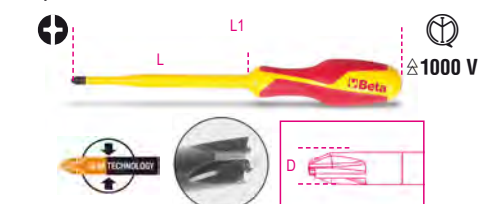

EN60900

PH1+LPP	€		
PH1+LPP	14,50	2	012750409
PH2+LPP	16,50	2	012750418

## 1276MQ/C

Chave combinada de parafusos PZ + cabeça com fenda

espessura reduzida

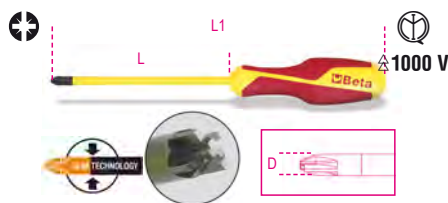

EN 60900

● PZ1+LPP	€ 13,70	2	012760409
● PZ2+LPP	€ 15,50	2	012760418

## 1279MQ/F

Chave de parafusos Pozidriv®-Supadriv®

espessura reduzida

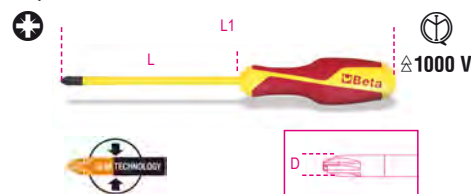

EN60900

pz	L mm	L1 mm	€		
1	80	180	14,50	3	012790409
2	100	208	16,50	3	012790418

## 1279MQ

chave de fenda para parafuso de perfil Pozidriv® - Supadriv®

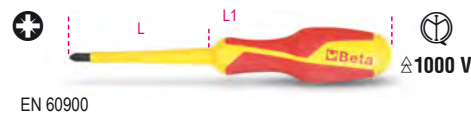

EN 60900

PZ	L mm	L1 mm	€		
0	60	160	10,90	3	012790703
1	80	188	13,20	3	012790709
2	100	219	15,20	3	012790718
3	150	277	20,00	2	012790724



1279MQ/S4	€ 59,00	1	012790751
PZ 0-1-2-3			

## 1725MQ

mini serrate



EN 60900

1725MQ	L mm 260	H mm 85	€ 101,00	1	012750030
--------	----------	---------	----------	---	-----------

## 1777MQ/C

navalha de descarnar cabo, isolada

• para cabos multi-núcleos



EN 60900

1777MQ/C	L mm 190	€ 40,50	1	017770026
----------	----------	---------	---	-----------

## 1777MQ/U

navalha de descarnar cabo, isolada



EN 60900

1777MQ/U	L mm 190	€ 37,00	1	017770011
----------	----------	---------	---	-----------

## 1777RL/U

4 lâminas de substituição para 1777MQ/U

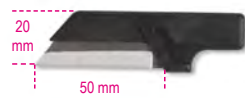

1777RL/U	€ 29,00	1	017770021
----------	---------	---	-----------

## 1995MQ/T

tapete isolante

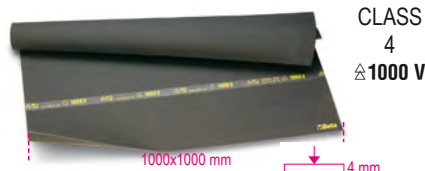

VDE 0303  
EN 60243

1995MQ/T	LxS mm 1000x1000	€ 336,00	1	019950030
----------	------------------	----------	---	-----------

## 1996MQ/T

Pano isolante

500x500mm

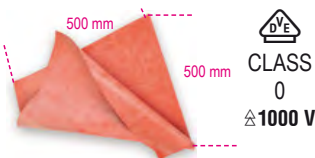

DIN EN 61112

1996MQ/T0,5	S mm 1.0	€ 102,00	1	019960005
-------------	----------	----------	---	-----------

## 1996VPG

aparelho de teste pneumático para luvas isolantes  
teste obrigatório conforme norma EN90603



1996VPG	€ 394,00	1	019960134
---------	----------	---	-----------

## 1997MQ/GM

luvas isolantes



EN 60903  
EN 61482

	Gr.	L mm	€		
1997MQ/GM 9	9	350	176,00	1	019970109
1997MQ/GM 10	10	350	176,00	1	019970110

## 2115P L-MQ32



2115PL-MQ32	354
-------------	-----

## 2029EM



2029EM	347
--------	-----

## 5989 VEM



5989 VEM	528
----------	-----







# FERRAMENTAS ANTI-QUEDA



## Beta H-SAFE

A gama de ferramentas H-SAFE de Beta inclui mais de 200 referências, para as quais foi projetado individualmente um sistema de retenção capaz de resistir às solicitações mecânicas mais rigorosas, como garantia de máxima segurança.

O conforto na utilização também é importante, nas chaves com utilização das duas extremidades, como a chave de boca/luneta art. 42, existe um cabo se movimenta ao longo de todo o corpo da ferramenta (foto), enquanto nas ferramentas manobradas com torção, por exemplo a chave de parafuso, existem anéis de rotação livre para não causar torção do cabo.



O sistema de retenção H-SAFE foi projetado, testado e fabricado nas unidades industriais Beta. Com o sistema de segurança H-SAFE de Beta as ferramentas estão sempre ao alcance da mão de forma confortável e segura.

## 35HS

escopros planos série nervurada H-SAFE



L mm	A mm	€		
200	23,0	43,50	1	000354004
250	28,5	55,00	1	000354005

## 42HS

chaves mistas boca/luneta H-SAFE



DIN 3113 UNI-ISO 7738

mm	L mm	€		
6x6	95	22,50	1	000424506
7x7	105	22,80	1	000424507
8x8	116	23,00	1	000424508
9x9	127	23,70	1	000424509
10x10	137	24,00	1	000424510
11x11	148	24,60	1	000424511
12x12	158	24,90	1	000424512
13x13	169	25,00	1	000424513
14x14	180	26,50	1	000424514
15x15	190	26,50	1	000424515
16x16	201	27,50	1	000424516
17x17	212	28,50	1	000424517
18x18	222	29,00	1	000424518
19x19	233	29,50	1	000424519
20x20	243	31,00	1	000424520
21x21	254	33,00	1	000424521
22x22	264	34,00	1	000424522
23x23	275	35,00	1	000424523
24x24	285	37,00	1	000424524
25x25	296	37,50	1	000424525
26x26	307	38,50	1	000424526
27x27	317	41,00	1	000424527
28x28	328	41,50	1	000424528
29x29	338	45,50	1	000424529
30x30	349	47,00	1	000424530
32x32	370	52,00	1	000424532
34x34	391	85,50	1	000424534
36x36	412	93,50	1	000424536



### 55HS

chaves de bocas H-SAFE



UN-HISO 10102 DIN 3110

mm	L mm	€		
• 6x7	120	17,90	1	000554012
• 8x9	140	18,40	1	000554021
• 10x11	155	18,70	1	000554030
• 12x13	170	20,30	1	000554042
• 14x15	185	20,80	1	000554054
• 16x17	202	22,10	1	000554060
• 18x19	220	23,60	1	000554066
• 20x22	236	24,90	1	000554075
• 21x23	245	26,50	1	000554078
• 22x24	245	28,00	1	000554081
• 24x27	262	30,50	1	000554090
• 30x32	297	38,50	1	000554108
• 34x36	325	86,00	1	000554117

### 91HS-C

chaves de luneta inclinada para serviços pesados H-SAFE



mm	Ø mm	€		
36	54	105,00	1	000914036
41	62	123,00	1	000914041
46	69	143,00	1	000914046

### 91HS

chaves de luneta inclinada para serviços pesados H-SAFE



mm	Ø mm	€		
36	54	210,00	1	000914236
41	62	228,00	1	000914241
46	69	268,00	1	000914246

### 92HS

cabo tubular para a chave refª. 91 H-SAFE



L mm	91 mm	Ø mm	€		
610	32÷41	22	105,00	1	000924020
760	46÷55	25	126,00	1	000924030

### 93HS

chave de lunetas com curvatura profunda especial para andaimes H-SAFE



mm	L mm	€		
21x22	310	61,00	1	000934021

### 96TBP-HS

chaves offset sextavadas cabeça de bola, com punhos de torque elevado e sistema de segurança H-SAFE

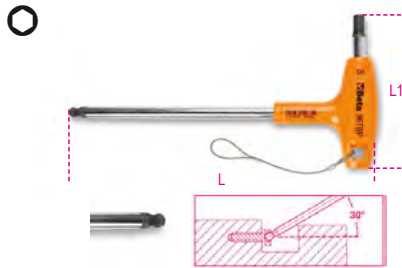

Ø mm	L mm	L1 mm	Ø mm	€		
2,5	153	55	4	28,50	1	000964685
3	153	55	4	29,50	1	000964686
4	179	70	5	30,00	1	000964687
5	200	84	6	30,50	1	000964688
6	221	103	7	33,00	1	000964689
8	255	117	10	38,50	1	000964690
10	285	132	12	42,00	1	000964692

### 96THS

chaves macho hexagonal com punho H-SAFE

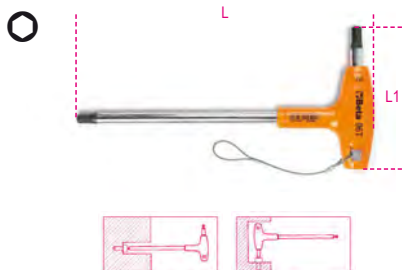

mm	L mm	L1 mm	€		
2,5	153	55	27,50	1	000964935
3	153	55	28,00	1	000964936
4	179	70	28,50	1	000964938
5	200	84	29,00	1	000964940
6	221	103	31,00	1	000964941
8	255	117	37,00	1	000964943
10	285	132	40,00	1	000964945

### 96THS-AS

chaves macho hexagonal com punho H-SAFE



"	L mm	L1 mm	Ø mm	€		
5/32	200	84	6	31,00	1	000964673
3/16	200	84	6	31,00	1	000964674
7/32	221	103	7	34,50	1	000964675
1/4	236	106	8	35,50	1	000964676
5/16	255	117	10	38,50	1	000964678
3/8	285	132	12	42,50	1	000964680

### 97TTXHS

chaves duplas macho com punho para parafusos com cabeça Torx® H-SAFE

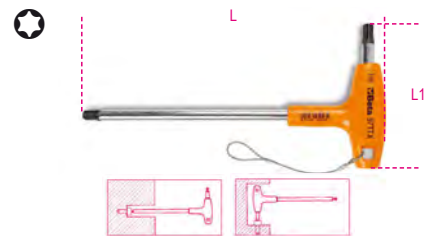

Ø	L mm	L1 mm	€		
T10	179	70	28,00	1	000974710
T15	179	70	28,50	1	000974715
T20	179	70	29,00	1	000974720
T25	179	70	29,50	1	000974725
T30	200	84	34,00	1	000974730
T40	221	103	36,00	1	000974740
T45	236	106	39,00	1	000974745
T50	255	117	47,50	1	000974750

### 111E-HS

chaves ajustáveis com escalas, cromadas

com sistema de segurança H-SAFE

- Rotação do pino à direita
- Escala mm/polegadas



DIN 3117 ISO 6787

L mm	L "	A max mm	€		
200	8	29	56,00	1	001114120
250	10	34	63,50	1	001114125
300	12	40	78,50	1	001114130
380	15	45	133,00	1	001114138
450	18	54	211,00	1	001114145



## 142HS

chaves boca/luneta com sistema de roquete H-SAFE



Ø mm	L mm	€	🔧	📦
8x8	136	35,00	1	001424008
9x9	143	36,00	1	001424009
10x10	159	37,00	1	001424010
11x11	168	37,50	1	001424011
12x12	174	38,00	1	001424012
13x13	180	39,00	1	001424013
14x14	190	40,00	1	001424014
15x15	200	41,50	1	001424015
16x16	216	44,50	1	001424016
17x17	233	45,50	1	001424017
18x18	239	48,00	1	001424018
19x19	248	48,50	1	001424019
21x21	285	58,50	1	001424021
22x22	285	59,50	1	001424022
24x24	325	69,00	1	001424024
27x27	355	92,00	1	001424027
30x30	420	106,00	1	001424030
* 32x32	420	110,00	1	001424032

## 360HS

chaves para tubos modelo Stillson H-SAFE



L mm	Ø max * mm	€	🔧	📦
250	1" gas	57,00	1	003604025
350	1 1/2" gas	70,50	1	003604035
450	2" gas	91,50	1	003604045
600	2 1/2" gas	130,00	1	003604060



LC system, sistemade retenção com esfera dupla, com liberação da chave de caixarealizada apenas com o botão

## 666HS

chaves dinâmicas ZERO-RESET com roquetes reversíveis, para aperto à direita, precisão de torque: ±3%

com sistema de fixação H-SAFE

• Não é necessário libertar a tensão



ISO 6789

Nm	□	D mm	A mm	L mm	LC system	🔧	📦
10÷50	3/8	30	33	342	-	680	0,25

€	🔧	📦
291,00	1	006664705

Nm	□	D mm	A mm	L mm	LC system	🔧	📦
20÷100	3/8	30	33	385	-	760	0,25

€	🔧	📦
295,00	1	006664710

Nm	□	D mm	A mm	L mm	LC system	🔧	📦
40÷200	1/2	42	43	471	*	1020	0,5

€	🔧	📦
332,00	1	006664721

Nm	□	D mm	A mm	L mm	LC system	🔧	📦
60÷300	1/2	42	43	600	*	1270	1,0

€	🔧	📦
373,00	1	006664731

## 900HS/55

roquete reversível com sistema antiquesada H-SAFE



DIN 3122 - UNI-ISO 3315

L mm	Ø mm	A mm	□	€	🔧	📦
127	25	29	1/4	59,00	1	009004155

## 910HS/55

roquete reversível com sistema antiquesada H-SAFE



DIN 3122 - UNI-ISO 3315

L mm	Ø mm	A mm	□	€	🔧	📦
207	31	33	3/8	67,50	1	009104155

## 920HS/55LC

roquete reversível, "LC System", com sistema antiquesada H-SAFE



DIN 3122 - UNI-ISO 3315

L mm	Ø mm	A mm	□	€	🔧	📦
271	40	41	1/2	97,00	1	009204159

## 932HS

chaves de cachimbo 6 faces/12 faces em cromado brilhante H-SAFE

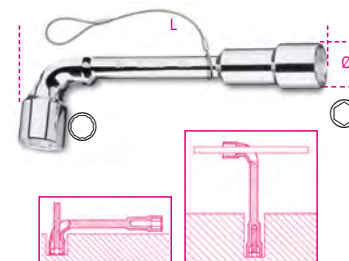

NF E 74.303

Ø mm	L mm	€	🔧	📦
6x6	11,5	110	29,50	1 009324006
7x7	12,5	116	30,50	1 009324007
8x8	13,0	120	32,50	1 009324008
9x9	14,0	125	33,00	1 009324009
10x10	16,5	133	34,00	1 009324010
11x11	17,5	143	35,50	1 009324011
12x12	19,0	148	37,00	1 009324012
13x13	19,5	154	37,50	1 009324013
14x14	21,5	167	40,00	1 009324014
15x15	22,5	182	40,50	1 009324015
16x16	24,5	193	41,50	1 009324016
17x17	26,0	198	42,50	1 009324017
18x18	26,5	215	45,50	1 009324018
19x19	29,0	220	48,00	1 009324019





## 1032HS

alicates de freios interiores com pontas direitas e punhos em PVC H-SAFE



UNI 7914 DIN 5256

L	Ø	Ø1	A	€		
mm	mm	mm	mm			
140x1,3	12÷25	1,3	20	41,00	1	010324014
180	19÷60	1,9	21	43,50	1	010324017

## 1034HS

alicates de freios interiores com pontas curvas a 90° e punhos em PVC H-SAFE



UNI 7914 DIN 5256

L	Ø	Ø1	A	€		
mm	mm	mm	mm			
170	19÷60	1,9	21	46,00	1	010344017

## 1036HS

alicates de freios exteriores com pontas direitas e punhos de PVC H-SAFE



UNI 7915 DIN 5254

L	Ø	Ø1	A	€		
mm	mm	mm	mm			
140x1,3	10÷25	1,3	20	43,50	1	010364014
175	19÷60	1,9	21	44,50	1	010364017

## 1038HS

alicates de freios exteriores com pontas curvas a 90° e punhos em PVC H-SAFE



UNI 7915 DIN 5254

L	Ø	Ø1	A	€		
mm	mm	mm	mm			
175	19÷60	-	21	47,50	1	010384017

## 1048BM-HS

alicate ajustável, charneira fechada, punhos de 2 componentes H-SAFE

· novo modelo com 9 posições



ISO 8976

L	A max	L1	g	€		
mm	mm	mm	g			
250	48	39	460	68,50	1	010484215

## 1052HS

alicates de pressão, maxilas côncavas H-SAFE



L	A	A1 max	S	€		
mm	mm	mm	mm			
240	72	42	10,0	56,50	1	010524024

## 1082BM-HS

alicates de corte diagonal, punhos bi-material H-SAFE



UNI/ISO 5749

L	L1	mm	A	€		
mm	mm	mm	mm			
160	22	1,6	28,0	55,50	1	010824036

## 1088BM-HS

alicates de corte frontal para serviços pesados, punhos bi-material H-SAFE

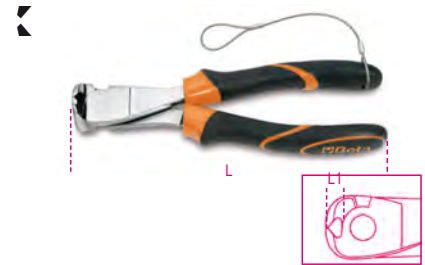

UNI/ISO 5748

L	L1	mm	A	€		
mm	mm	mm	mm			
160	9	1,6	28,0	64,00	1	010884036
200	11	2,0	36,0	80,00	1	010884040

## 1128BAX-HS

Tesoura de electricista com perfis de escareação graduados, lâminas em aço inox com revestimento DLC H-SAFE

Gumes de corte duplo: pino excêntrico especial permite que as lâminas se movimentem a todo o comprimento, aumentando a eficiência de corte. H-SAFE

Concebida para alargar furos em plástico, de 13 mm a 25 mm.

Revestimento DLC (diamond-like carbon) é um revestimento inovador à base de carbono: a elevada dureza e baixo atrito resultam da combinação de carbono, sob a forma de grafite, e diamante.

- Elevada dureza da superfície da lâmina (resistência à abrasão e desgaste)
- Baixa fricção (suavidade e antiaderência)
- Pino excêntrico especial
- Punhos de grandes dimensões com ranhura para corte de cabos e cravagem de terminais
- Com caixa em plástico articulada



L	L1	mm²	€		
mm	mm	mm²			
150	50	50	53,00	1	011284088

## 1132BM-HS

cuta-cabos para cabos isolados de cobre alumínio com punhos bi-material H-SAFE



UNI 8791

L	mm	A	B	€		
mm	mm	mm	mm			
230	18	37	12,5	97,00	1	011324143

## 1150BM-HS

alicates universais em cromado brilhante com punhos bi-material H-SAFE



ISO 5746

L mm	L1 mm	mm	A mm	€		
160	42	1,6	22,0	48,00	1	011504146
180	46	1,8	25,0	50,50	1	011504148
200	50	2,0	27,0	55,50	1	011504150

## 1166BM-HS

alicates de pontas semi-redondas com estrias, extra-longas, e punhos bi-material H-SAFE



ISO 5745

L mm	L1 mm	mm	A mm	€		
200	76	1,6	22,0	57,00	1	011664040

## 1168BM-HS

alicates de pontas curvas semi-redondas com estrias, extra-longas, e punhos bi-material H-SAFE



ISO 5745

L mm	L1 mm	mm	A mm	€		
200	70	1,6	22,0	60,00	1	011684040



## 1290HS

chaves para parafusos de perfil de fenda H-SAFE



ISO 2380

SxAxL mm	L1 mm	Ø mm	€		
0,4x2,5x75	171	2,5	19,80	1	012904006
0,5x3x100	196	3,0	20,50	1	012904012
0,6x3,5x100	196	3,5	21,80	1	012904021
0,8x4x100	196	4,0	21,40	1	012904030
0,8x4x150	246	4,0	22,80	1	012904036
1x5,5x150	259	5,0	25,50	1	012904042
1,2x6,5x150	270	6,0	27,00	1	012904051
1,2x8x150	282	7,0	29,50	1	012904057
1,6x10x200	332	8,0	35,00	1	012904066

## 1292HS

chaves para parafusos de perfil Phillips® H-SAFE



UNI/ISO 8764

PHxDxL mm	L1 mm	€		
0x3x100	196	20,70	1	012924006
1x4,5x120	229	22,90	1	012924012
2x6x150	270	27,50	1	012924021
3x8x150	282	31,50	1	012924024

## 1294HS

chaves para parafusos de perfil de fenda sem cabeça H-SAFE



SxDxL mm	L1 mm	€		
0,5x2,5x60	156	19,30	1	012944003
0,6x3x75	171	19,50	1	012944006
0,8x4x100	196	21,50	1	012944012
1x5x125	234	25,00	1	012944018

## 1299HS

chaves para parafusos de perfil Pozidriv® - Supadriv® H-SAFE



UNI/ISO 8764

PZ	L mm	L1 mm	€		
0	60	156	21,70	1	012994000
1	80	189	24,30	1	012994003
2	100	220	29,50	1	012994006
3	150	282	37,50	1	012994009

## 1370T-HS

martelos para mecânica cabo em fibra H-SAFE



g	A mm	L mm	L1 mm	€		
300	23	300	105	41,00	1	013704630
500	27	320	118	44,00	1	013704650
1000	36	360	135	55,50	1	013704700

## 1370FT-HS

martelos para mecânicos, cabos em fibra H-SAFE



A mm	L mm	L1 mm	B mm	€		
28	280	86	22	56,50	1	013704528
30	280	92	24	57,00	1	013704530
36	300	104	29	67,50	1	013704536

## 1390HS

martelos com batentes plásticos intermutáveis, cabo em madeira H-SAFE



UNI 7784

D mm	L mm	L1 mm	€		
35	310	95	52,00	1	013904035
45	320	107	73,50	1	013904045

## 1392HS

martelos anti-recuo com batentes intermutáveis, cabo em aço H-SAFE



D	L	L1	€		
mm	mm	mm			
35	305	115	75,00	1	013924035
40	310	125	84,00	1	013924040
50	325	135	98,00	1	013924050
60	385	155	143,00	1	013924060

## 1602A-HS

alicate para cravar terminais isolados modelo standard H-SAFE

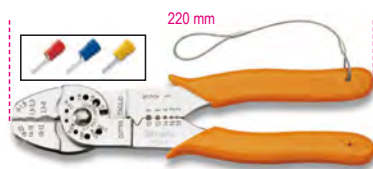

mm <sup>2</sup>	L	A	B	€		
0÷6	mm	mm	mm			
0÷6	220	42	4	80,00	1	016024005

## 1682HS

régua graduada flexível em aço inoxidável H-SAFE



L	H	±	€		
mm	mm	mm			
200	13	0,5	17,90	1	016824020
300	13	0,5	20,30	1	016824030



## 1692HS

fitas métricas, caixa em ABS anti-choque, fitas em aço, classe de precisão II H-SAFE

CE



L	S	€		
m	mm			
3	16	24,30	1	016924053
5	19	28,50	1	016924055

## 1708HS/20

apalpa-folgas H-SAFE

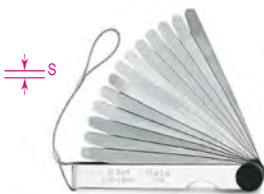

S	S	L	€		
mm	mm	mm			
0,05÷1,0	0,002÷0,040	105	26,50	1	017084020

## 1727HS

serrote, série pesada H-SAFE

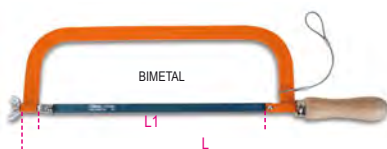

L	L1	€		
mm	mm			
515	300	37,00	1	017274001

## 1743HS

alicate para abraçadeiras em Nylon H-SAFE

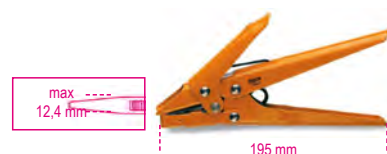

L	A	B	€		
mm	mm	mm			
195	85	17	76,50	1	017434001

## 1750HS

pistola de massa H-SAFE



1 g, 550 bar Max

cc	L	€		
500	mm			
500	380	64,50	1	017504500

## 1760BHS

multímetro digital H-SAFE

CE



### ESPECIFICAÇÕES

Voltagem DC: 200 mV-2/20/200/1000V  
 Voltagem AC: 2-20/200/700V  
 Corrente DC: 2/20/200 mA-20 A  
 Corrente AC: 2/200 mA- 20 A  
 Resistência: 200Ω - 2/20/200 kΩ - 2/20 MΩ  
 Capacidade: 2/20/200 nF - 2/200 μF  
 Temperatura: -20° + 1000°C/ -4 °F ~ +2000°F  
 Frequência: 20kHz  
 Potência de alimentação: Pilha 1 9V (incluída)

1760BHS	€		
1760BHS	253,00	1	017604012

## 1772H-HS

x-acto de lâmina retráctil, de segurança, lâmina de substituição H-SAFE



L	A	€		
mm	mm			
170	18	33,00	1	017724029



## 1778S0S-HS

navalha manutenção automóvel com quebra-janelase cortante para cintos de segurança fornecida em bolsa H-SAFE



L mm	A mm	L1 mm	€	1	017784080
205	25	85	53,00	1	017784080

## 8871

Cinto de segurança com fivela metálica de fecho duplo



8871 70	8871 100	L cm min-max	€	1	088710070	1	088710100
		70-100	150,00	1	088710070	1	088710100
		100-135	162,00	1	088710100		

## 8872A

Passador fixo

• Para cinto 8871



8872A 50	€	1	088720050
	26,50	1	088720050

## 8872AS

Passador com abertura auto-aderente

• Para cinto 8871



8872AS 25	€	1	088720525
	24,30	1	088720525

## 8873

Saco porta-ferramentas com auto-aperto e fecho de correr

• Para cinto 8871



8873 230	€	1	088730230
	127,00	1	088730230

## 8877

Elemento de conexão com amortecimento

• MAX 2.7 kg



8877 80	L cm min+max	DxL mm	€	1	088770080
	70-110	40x80	32,50	1	088770080

## 8877M

Elemento de conexão com amortecimento

• Com junta antitorção  
• MAX 2.7 kg



8877M 20-140	L cm min+max	DxL mm	€	1	088770510
	20-140	30x60	58,00	1	088770510

## 8879

Faixa para pulso auto-aderente

• MAX 2.7 kg



8879	D mm	€	1	088790025
	30	37,50	1	088790025

## 8880

Amarração de conexão rígida

• Com junta antitorção



8880 30	L Cm	D mm	€	1	088800030
	30	10	29,00	1	088800030

## 8883

Saco porta-ferramentas

• Em nylon 840 anti-abrasão • MAX 20 kg • Mosquetão para bloquear o fecho de correr no fim de curso • 6 amarrações de retenção ferramenta • Com bolso interno



8883	DxH Cm	€	1	088830030
	30x40	307,00	1	088830030





# FERRAMENTAS EM AÇO INOX



INOX + NO INOX  
= FERRUGEM

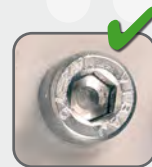

INOX + INOX  
= SEM FERRUGEM

As Ferramentas BETA INOX podem ser utilizadas em ambientes críticos - ou seja, áreas onde não é permitido um nível mínimo de contaminação.

Alguns exemplos incluem:

- Aplicações nucleares
- Indústria farmacêutica - classe C
- Aplicações em plataformas off-shore
- Laboratórios biotecnológicos e biomédicos
- Indústria alimentar.

As ferramentas Beta Inox evitam a formação indevida de ferrugem.

Ao utilizar outras ferramentas em parafusos, porcas ou superfícies em aço inox, são libertadas algumas partículas que desencadeiam a corrosão. Muitas vezes isso resulta em problemas estéticos e, por vezes, também em problemas estruturais.

Alguns exemplos de aplicações:

- Estaleiros navais
- Construção
- Sistemas solares
- Indústria automóvel.

## CARACTERÍSTICAS

A seleção dos melhores materiais<sup>1</sup> e busca contínua do melhor tratamento térmico conferem às ferramentas Beta Inox características mecânicas que excedem largamente as normas em vigor, sendo comparáveis à restante gama de Ferramentas Beta.

Também apresentam características ergonômicas e de design idênticas à linha Beta tradicional, amplamente reconhecida e apreciada pelos utilizadores profissionais há mais de 75 anos. O aço inox é 100% reciclável, o que também representa uma grande vantagem em termos ambientais.



Marcação para produtos em aço inox  
Trata-se de uma marcação emitida pelo Centro Inox - Associação Italiana de Desenvolvimento de Aço Inoxidável, que caracteriza os produtos fabricados em aço inox.

## 34INOX

Escopros planos, em aço inox



L mm	A mm	Ø mm	€		
100	14	14	34,00	1	000340314
160	18	18	45,50	1	000340318
200	20	20	67,50	1	000340320

## 39INOX

Cunhas, em aço inox



L mm	A mm	S mm	€		
100	50	10	31,50	1	000390310
150	50	13	57,00	1	000390315
200	40	40	167,00	1	000390320

## 42INOX

chave boca/luneta  
em aço inox



DIN 3113 - UNI ISO 7738

Ø mm	L mm	€		
6x6	95	15,90	2	000420306
7x7	105	16,50	2	000420307
8x8	116	16,60	2	000420308
9x9	127	17,80	2	000420309
10x10	137	18,90	2	000420310
11x11	148	20,40	2	000420311
12x12	158	21,30	2	000420312
13x13	169	21,50	2	000420313
14x14	180	22,30	2	000420314
15x15	190	22,90	2	000420315
16x16	201	23,50	2	000420316
17x17	212	26,50	2	000420317
18x18	222	28,50	2	000420318
19x19	233	30,50	2	000420319
21x21	254	37,50	1	000420321
22x22	264	38,50	1	000420322
24x24	285	42,50	1	000420324
27x27	290	132,00	1	000420327
30x30	320	161,00	1	000420330
32x32	340	175,00	1	000420332
36x36	360	246,00	1	000420336
38x38	430	262,00	1	000420338
41x41	430	308,00	1	000420341
46x46	480	353,00	1	000420343
50x50	520	381,00	1	000420345
55x55	560	412,00	1	000420347
60x60	595	459,00	1	000420350



€		
240,00	1	000420391

42INOX/S11  
6-8-10-11-12-13-  
14-15-16-17-19 mm



€		
210,00	1	000420387

42INOX/SC9  
8-10-11-12-13-14-15-17-19 mm

€		
11,00	1	000420303

42INOX/SCV9

## 42INOX-AS

chaves combinadas,  
boca/luneta,  
em aço inoxidável



"	L mm	€		
1/4x1/4	95	19,10	1	000420356
5/16x5/16	116	19,30	1	000420358
3/8x3/8	137	23,10	1	000420360
7/16x7/16	148	25,00	1	000420361
1/2x1/2	169	25,50	1	000420363
9/16x9/16	180	27,50	1	000420364
5/8x5/8	201	29,00	1	000420366
11/16x11/16	212	33,50	1	000420367
3/4x3/4	233	37,00	1	000420369
13/16x13/16	254	42,50	1	000420371
7/8x7/8	264	44,50	1	000420372
15/16x15/16	285	50,50	1	000420373



€		
239,00	1	000420396

42INOX-AS/S9  
1/4-5/16-3/8-7/16-1/2  
9/16-5/8-11/16-3/4



## 96BPINOX

chave sextavada cabeça de bola,  
em aço inox



mm	L mm	L1 mm	Ø g	€		
2	91	22	4	5,60	4	000961441
2,5	91	22	6	5,60	4	000961442
3	101	24	11	5,90	4	000961443
4	112	29	19	6,70	4	000961444
5	131	33	32	7,90	4	000961445
6	154	36	51	8,70	4	000961446
7	164	40	65	11,30	2	000961447
8	175	44	116	13,80	2	000961448
10	197	51	189	17,10	2	000961450



€		
55,00	1	000961455

96BPINOX/B6  
2,5-3-4-5-6-8 mm

€		
89,00	1	000961456

96BPINOX/B9  
2-2,5-3-4-5-  
6-7-8-10 mm

€		
6,80	1	000961459

96BPINOX/BV

## 96BPINOX-AS

chaves de bola sextavadas,  
em aço inoxidável



"	L mm	L1 mm	Ø g	€		
5/64	91	22	5,5	7,20	4	000961989
3/32	91	22	5,3	7,20	4	000961990
7/64	101	24	10,5	7,80	4	000961991
1/8	101	24	10,7	7,80	4	000961992
9/64	112	29	18,7	8,50	4	000961993
5/32	112	29	18,7	8,50	4	000961994
3/16	131	33	31,5	11,30	2	000961995
7/32	154	36	50,0	11,70	2	000961996
1/4	164	40	70,0	12,50	2	000961997
5/16	175	44	115,0	14,70	2	000961998
3/8	197	51	186,5	18,30	2	000961999



€		
87,50	1	000962000

96BPINOX-AS/B8  
5/64-3/32-1/8-5/32-  
3/16-7/32-1/4-5/16

€		
6,80	1	000961459

96BPINOX/BV



## 96TINOX

chave sextavada, com punho de binário elevado, em aço inox

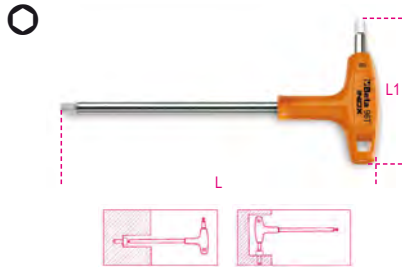

mm	L mm	L1 mm	€	🔧	📦
2,5	153	55	13,50	2	000961935
3	153	55	14,00	2	000961936
4	179	70	15,40	2	000961938
5	200	84	17,00	2	000961940
6	221	95	18,60	2	000961941
7	236	106	21,40	2	000961942
8	255	117	25,50	2	000961943
10	285	132	32,50	2	000961944



96TINOX/S5 2,5-3-4-5-6 mm	78,50	1	000961952
96TINOX/S8 2,5-3-4-5-6-7-8-10 mm	158,00	1	000961954

## 96TINOX-AS

chaves sextavadas, com punhos de elevado aperto, em aço inoxidável

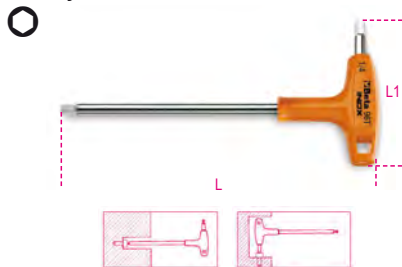

"	L mm	L1 mm	Ø mm	€	🔧	📦
3/32	153	55	3	14,70	2	000961861
7/64	153	55	4	15,00	2	000961862
1/8	179	70	4	16,90	2	000961863
9/64	179	70	5	17,20	2	000961864
5/32	200	84	6	18,10	2	000961865
3/16	200	84	6	19,50	2	000961866
7/32	221	103	7	22,70	2	000961867
1/4	236	106	8	23,70	2	000961868
5/16	255	117	10	29,00	2	000961869
3/8	285	132	12	31,50	2	000961870



96TINOX-AS/S7 3/32-1/8-5/32-3/16-7/32-1/4-5/16	145,00	1	000961877
---	--------	---	-----------

## 111INOX

Chaves ajustáveis, em aço inox



DIN 3117 - ISO 6787

L mm	L mm	A max mm	A1 mm	€	🔧	📦
150	6	18	45	97,50	1	001110315
200	8	24	58	135,00	1	001110320
250	10	30	70	169,00	1	001110325

## 362INOX

chaves para tubos para trabalhos pesados, aço inox



L mm	Ø max mm	€	🔧	📦
300	58	228,00	1	003620430

## 920INOX-A

Chaves de caixa sextavadas, em aço inox



DIN 3124 - UNI ISO 2725

Ø mm	Ø mm	A mm	L mm	€	🔧	📦
8	15	10	40	33,50	2	009203008
9	16	10	40	35,50	2	009203009
10	17	10	40	37,50	2	009203010
11	18	11	40	40,00	2	009203011
12	19	11	40	42,50	2	009203012
13	20	11	40	45,00	2	009203013
14	21	11	40	47,00	2	009203014
15	23	11	40	49,50	2	009203015
16	24	11	40	52,00	2	009203016
17	25	11	40	53,50	2	009203017
18	26	13	42	55,50	2	009203018
19	28	13	42	57,50	2	009203019
20	29	13	42	61,50	1	009203020
21	30	13	43	62,50	1	009203021
22	31	15	43	63,00	1	009203022
24	34	15	43	73,00	1	009203024
27	38	18	46	89,50	1	009203027
30	42	20	46	107,00	1	009203030
32	44	20	46	120,00	1	009203032



## 920/55INOX

Roquete reversível quadra 1/2", 72 dentes, em aço inox



L mm	Ø mm	A mm	€	🔧	📦
264	40	43	259,00	1	009203882

## 920/R55INOX



920/R55 INOX	92,00	1	009203879
--------------	-------	---	-----------

## 1048INOX

Alicate ajustável, de charneira fechada, em aço inox

• Modelo de 7 posições

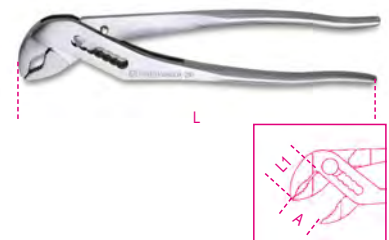

L mm	A max mm	L1 mm	€	🔧	📦
250	33	33	176,00	1	010480325

## 1082INOX

alicates de corte diagonal, em aço inox



L mm	L1 mm	mm	€	🔧	📦
150	20,0	1,6	128,00	1	010820350

## 1150INOX

alicates universais para trabalhos pesados, em aço inox

pino descentralizado  
junta aberta



L	L1	€		
mm	mm			
180	39	117,00	1	011500518

## 1153INOX

Alicates ajustáveis com duas posições, aço inox



L	L1	€		
mm	mm			
150	26	122,00	1	011530315

## 1290INOX

chaves para parafusos de perfil de fenda em aço inox

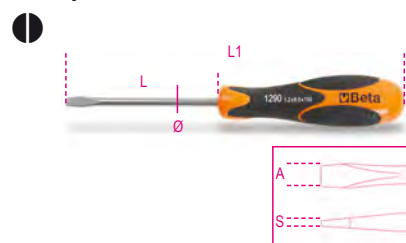

ISO 2380

SxAxL mm	L1 mm	Ø mm	€		
0,4x2,5x50	146	2.5	9,90	4	012900403
0,5x3x75	171	3.0	10,10	4	012900409
0,8x4x100	196	4.0	10,50	4	012900430
1,0x5,5x150	259	5.0	13,40	4	012900442
1,2x6,5x150	270	6.0	15,40	4	012900451

## 1292INOX

chaves para parafusos de perfil Phillips®, em aço inox

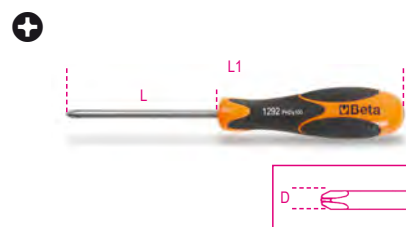

ISO 8764

PHxDxL mm	L1 mm	€		
0x3x60	156	9,20	4	012920403
1x4,5x80	189	10,90	4	012920409
2x6x100	220	13,40	4	012920418

## 1293INOX/D8

Jogo de 8 chaves de fendas em aço inox



1293INOX/D8	€		
	93,00	1	012930408
1290INOX	0,4x2,5x50-0,5x3x75		
	0,8x4x100-1,0x5,5x150		
	1,2x6,5x150 mm		
1292INOX	PH0x60-PH1x80		
	PH2x100 mm		

## 1370INOX

Martelo para mecânico tipo alemão, em aço inox



g	A	L	L1	€		
500	mm	mm	mm	111,00	1	013700375
	25	240	101			

## 1377INOX

martelos de bola, cabeça redonda, para trabalhos em cobre e latão, em aço inox



g	L	L1	€		
230	mm	mm	64,50	1	013770623
340	220	90	92,50	1	013770634

## 1730INOX

espátula universal, em aço inox



A	L	€		
mm	mm			
50	200	56,50	1	017300450

## C20TSS

Caixa de ferramentas extensível com 5 divisões, em aço inox AISI 304



C20TSS	€		
	321,00	1	021203001
≡: 450x200x210 mm - 4 Kg			

## T23



T23	560
TV23	560

## T99



T99	563
TV99	563

## T228



T228	567
TV180	566-567

## C04TSS-7

carro com sete gavetas, totalmente em aço inoxidável, rodas anti-marcas

Principais características:

- Sete gavetas (570 x 410 mm) com calhas assentes em rolamentos de esferas;
- 6 gavetas, 83 mm altura;
- 1 gaveta, 170 mm altura;
- 4 rodízios Ø 125 mm
- 2 fixos e 2 giratórios (dois com travão);
- Fechadura frontal centralizada;
- Estrutura totalmente fabricada em aço inoxidável
- Roletes, suportes, esferas, interiores de gavetas e calhas em aço inoxidável
- Pegas das gavetas em alumínio

63 kg

**Beta**  
**INOX**  
STAINLESS STEEL

700  
kg

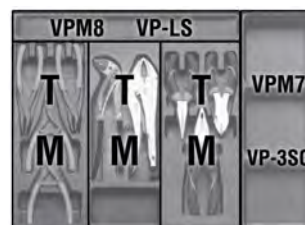

h	max
83 mm	25 kg
170 mm	30 kg

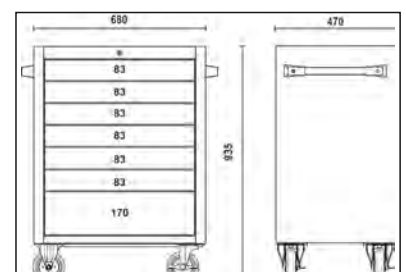
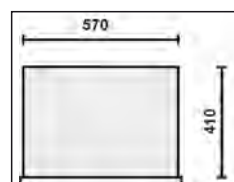

C04TSS/7

€ 2.870,00 1 024003077





# FERRAMENTAS ANTI-FAÍSCA



## COBRE-BERÍLIO Cu-Be

As ferramentas anti-faísca da **Beta** foram especialmente concebidas para operar com segurança em atmosferas potencialmente explosivas, na presença de líquidos ou gases inflamáveis, ou para aplicações que requerem ferramentas não magnéticas e resistentes à corrosão.



As ferramentas antifaiscantes da Beta são certificadas pelo Federal Institute for Materials Research and Testing, BAM, sob diretiva Europeia 99/92/EC



### AVISO!

Risco de explosão em ambientes expostos a **ACETILENO**

As características mecânicas das ferramentas anti-faísca diferem das características das ferramentas em aço normais. As ferramentas anti-faísca devem ser utilizadas com extrema precaução, evitando sobrecargas.

## CLASSIFICAÇÃO DE ATMOSFERAS POTENCIALMENTE EXPLOSIVAS

ATEX	MÉDIO-BAIXO		EXTREMAMENTE BAIXO	
	GASES	<b>ZONA 1</b> Área onde é provável, em condições normais de funcionamento, a formação ocasional de uma atmosfera explosiva constituída por uma mistura de ar com substâncias inflamáveis, sob a forma de gás, vapor ou névoa.		<b>ZONA 2</b> Área onde não é provável, em condições normais de funcionamento, a formação de uma atmosfera explosiva constituída por uma mistura de ar com substâncias inflamáveis, sob a forma de gás, vapor ou névoa, ou onde essa formação, caso se verifique, seja de curta duração.
POEIRAS		<b>ZONA 21</b> Área onde é provável, em condições normais de funcionamento, a formação ocasional de uma atmosfera explosiva sob a forma de uma nuvem de poeira combustível.		<b>ZONA 22</b> Área onde não é provável, em condições normais de funcionamento, a formação de uma atmosfera explosiva sob a forma de uma nuvem de poeira combustível, ou onde essa formação, caso se verifique, seja de curta duração.

### 30BA

punção anti-faísca



Ø mm	L mm	S mm	€	📦	📄
5	150	15	75,00	1	000300806
8	150	17	93,00	1	000300808
10	150	19	115,00	1	000300810

### 31BA

punção anti-faísca



Ø mm	L mm	€	📦	📄
3	110	32,50	1	000310853
4	110	70,50	1	000310854
6	115	108,00	1	000310856
8	120	122,00	1	000310858

### 31BA/C

Punção cónico antifaísca



Ø mm	Ø1 mm	L mm	€	📦	📄
*6	12	150	44,00	1	000310876
*7	13	150	52,00	1	000310877
*12	18	175	111,00	1	000310882
*13	29	255	346,00	1	000310883

### 32BA

punções anti-faísca



● mm	L mm	€	📦	📄
14	150	104,00	1	000320811

### 34BA

escopro plano anti-faísca



L mm	A mm	€	📦	📄
200	22	141,00	1	000340801
250	24	235,00	1	000340803
300	25	317,00	1	000340802

## 39BA

cunha anti-faísca



L mm	A mm	€	🔧	📦
150	40	62,00	1	000390801
230	40	207,00	1	000390802
250	40	323,00	1	000390803

## 42BA

chave boca-luneta bi-sextavada anti-faísca



mm	L mm	€	🔧	📦
6x6	105	66,00	1	000420806
7x7	105	74,00	1	000420807
8x8	120	83,00	1	000420808
9x9	120	95,00	1	000420809
10x10	135	102,00	1	000420810
11x11	135	108,00	1	000420811
12x12	150	118,00	1	000420812
13x13	150	122,00	1	000420813
14x14	175	128,00	1	000420814
15x15	175	135,00	1	000420815
16x16	195	140,00	1	000420816
17x17	200	147,00	1	000420817
18x18	215	164,00	1	000420818
19x19	220	168,00	1	000420819
20x20	230	175,00	1	000420820
21x21	240	186,00	1	000420821
22x22	250	198,00	1	000420822
24x24	268	229,00	1	000420824
26x26	290	277,00	1	000420826
27x27	290	308,00	1	000420827
28x28	290	361,00	1	000420828
30x30	313	369,00	1	000420830
32x32	333	406,00	1	000420832
34x34	360	442,00	1	000420834
35X35	360	505,00	1	000420835
36x36	355	525,00	1	000420836
38x38	430	555,00	1	000420838
41x41	430	650,00	1	000420841
46x46	480	760,00	1	000420846
50x50	520	805,00	1	000420850
55x55	560	885,00	1	000420855
60x60	580	945,00	1	000420860
*65x65	595	1.080,00	1	000420865
*70x70	630	1.210,00	1	000420870

## 42BA-AS

chave boca-luneta bi-sextavada anti-faísca



mm	L mm	€	🔧	📦
9/32x9/32	120	70,50	1	000420946
5/16x5/16	120	70,50	1	000420947
11/32x11/32	135	90,00	1	000420948
3/8x3/8	128	95,00	1	000420950
7/16x7/16	135	108,00	1	000420951
15/32x15/32	140	119,00	1	000420949

"	L mm	€	🔧	📦
1/2x1/2	140	124,00	1	000420953
9/16x9/16	163	133,00	1	000420954
*19/32x19/32	195	160,00	1	000420955
5/8x5/8	177	161,00	1	000420956
11/16x11/16	195	172,00	1	000420957
3/4x3/4	215	177,00	1	000420959
13/16x13/16	230	207,00	1	000420961
7/8x7/8	235	215,00	1	000420962
15/16x15/16	256	238,00	1	000420964
*31/32x31/32	265	262,00	1	000420963
1x1	266	258,00	1	000420965
1.1/16x1.1/16	283	291,00	1	000420967
1.1/8x1.1/8	297	383,00	1	000420969
1.3/16x1.3/16	308	413,00	1	000420970
1.1/4x1.1/4	324	487,00	1	000420973
*1.7/16x1.7/16	360	590,00	1	000420976

## 55BA

chave de bocas anti-faísca



mm	L mm	€	🔧	📦
6x7	90	45,00	1	000550801
8x9	100	48,50	1	000550802
8x10	100	50,50	1	000550795
9x11	110	53,50	1	000550797
10x11	120	57,00	1	000550803
12x13	130	72,00	1	000550804
*12x14	130	87,00	1	000550846
13x14	133	86,50	1	000550799
14x15	145	87,00	1	000550805
14x17	150	93,00	1	000550806
16x17	165	94,50	1	000550807
17x19	170	124,00	1	000550847
18x19	170	126,00	1	000550809
*19x22	185	144,00	1	000550810
20x22	185	145,00	1	000550811
21x23	210	158,00	1	000550813
22x24	210	188,00	1	000550815
24x26	230	221,00	1	000550817
24x27	230	235,00	1	000550818
25x28	230	255,00	1	000550819
27x29	246	298,00	1	000550820
30x32	265	349,00	1	000550822
36x38	320	442,00	1	000550826
36x41	335	487,00	1	000550828
41x46	355	605,00	1	000550829
*46x50	370	695,00	1	000550830
*50x55	385	740,00	1	000550831
*55x60	415	915,00	1	000550832

## 55BA-AS

chave de bocas anti-faísca



"	L mm	€	🔧	📦
3/8x7/16	110	59,00	1	000550853
1/2x9/16	130	70,50	1	000550854
5/8x11/16	160	104,00	1	000550857
3/4x13/16	180	128,00	1	000550859
7/8x15/16	210	180,00	1	000550865
1x1.1/16	230	244,00	1	000550868
1.1/8x1.3/16	245	317,00	1	000550870
1.1/4x1.5/16	255	375,00	1	000550872

## 58BA

chaves de bocas de pancada anti-faísca



mm	L mm	€	🔧	📦
17	125	121,00	1	000580817
19	125	126,00	1	000580819
22	135	126,00	1	000580822
24	150	142,00	1	000580824
27	165	174,00	1	000580827
30	180	218,00	1	000580830
32	190	255,00	1	000580832
*34	200	292,00	1	000580834
36	210	303,00	1	000580836
38	220	332,00	1	000580838
41	230	375,00	1	000580841
46	240	448,00	1	000580846
50	255	510,00	1	000580850
*55	305	635,00	1	000580855
*60	315	740,00	1	000580860
*65	335	855,00	1	000580865
*70	370	1.040,00	1	000580870
*75	375	1.200,00	1	000580875
*80	400	1.430,00	1	000580880
*85	400	1.690,00	1	000580885
*90	445	2.000,00	1	000580890
*95	445	2.320,00	1	000580895
*100	485	2.680,00	1	000580900
*110	513	3.310,00	1	000580901

## 58BA-AS

chaves de bocas de pancada anti-faísca



mm	L mm	A mm	S mm	€	🔧	📦
*11/16	125	40,5	11,0	133,00	1	000580904
*3/4	125	40,5	11,0	136,00	1	000580905
*7/8	135	46,2	12,0	139,00	1	000580906
*15/16	150	50,3	12,0	159,00	1	000580907
*31/32	150	50,3	12,0	178,00	1	000580954
*1	175	56,9	15,0	185,00	1	000580908
*1.1/8	190	64,0	15,5	237,00	1	000580909
*1.1/4	190	64,0	15,5	279,00	1	000580910
*1.7/16	210	75,0	18,5	323,00	1	000580912
*1.1/2	220	82,0	18,5	384,00	1	000580913
*1.5/8	230	86,8	18,5	413,00	1	000580914
*1.3/4	250	98,0	20,	525,00	1	000580970

## 78BA

chave de luneta de pancada bi-sextavada anti-faísca



mm	L mm	€	🔧	📦
17	145	126,00	1	000780817
19	145	139,00	1	000780819
22	165	141,00	1	000780822
24	140	172,00	1	000780824
27	155	198,00	1	000780827
30	165	229,00	1	000780830
32	180	248,00	1	000780832
34	192	273,00	1	000780834
36	208	303,00	1	000780836
38	215	354,00	1	000780838
41	225	420,00	1	000780841
46	245	470,00	1	000780846
50	250	550,00	1	000780850
55	265	635,00	1	000780855

mm	L mm	€		
60	275	685,00	1	000780860
65	295	740,00	1	000780865
70	310	835,00	1	000780870
75	325	935,00	1	000780875
80	340	1.010,00	1	000780880
*85	355	1.280,00	1	000780885
*90	380	1.500,00	1	000780890
*95	390	1.740,00	1	000780895
*100	410	1.990,00	1	000780900
*105	420	2.200,00	1	000780903
*110	445	2.510,00	1	000780901
*120	480	2.960,00	1	000780902

## 78BA-AS

chave de luneta de pancada bi-sextavada anti-faísca



"	L mm	€		
11/16	145	125,00	1	000780908
3/4	145	130,00	1	000780909
7/8	155	145,00	1	000780935
15/16	165	160,00	1	000780936
*31/32	165	187,00	1	000780937
1	175	187,00	1	000780938
*1.1/16	175	222,00	1	000780939
1.1/8	180	224,00	1	000780940
1.3/16	185	233,00	1	000780941
1.1/4	177	254,00	1	000780910
*1.5/16	200	258,00	1	000780954
*1.3/8	205	270,00	1	000780911
1.7/16	208	337,00	1	000780912
*1.1/2	215	351,00	1	000780913
*1.9/16	225	435,00	1	000780947
*1.11/16	225	459,00	1	000780962
1.5/8	225	426,00	1	000780914
*1.3/4	235	470,00	1	000780963
1.13/16	243	487,00	1	000780916
1.7/8	235	555,00	1	000780915
2	254	575,00	1	000780918
2.3/16	264	670,00	1	000780920
2.3/8	275	730,00	1	000780922
*2.9/16	286	760,00	1	000780924
*2.15/16	311	920,00	1	000780926
*3.1/8	325	1.070,00	1	000780928
*3.1/2	355	1.350,00	1	000780930

## 89BA

chave de luneta simples anti-faísca



mm	L mm	€		
10	200	143,00	1	000890810
11	210	148,00	1	000890811
12	220	154,00	1	000890812
13	230	158,00	1	000890813
14	240	160,00	1	000890814
16	260	172,00	1	000890816
17	270	178,00	1	000890817
18	280	192,00	1	000890818
19	300	199,00	1	000890819
20	310	248,00	1	000890820
22	330	248,00	1	000890822
24	350	271,00	1	000890824
27	370	335,00	1	000890827
30	400	375,00	1	000890830
32	420	395,00	1	000890832

## 90BA

chave de luneta anti-faísca



mm	L mm	€		
6x7	122	45,50	1	000900801
8x9	128	59,00	1	000900802
10x11	155	67,00	1	000900803
12x13	175	78,50	1	000900806
12x14	180	84,00	1	000900807
14x15	200	94,50	1	000900808
14x17	220	96,00	1	000900809
16x17	230	113,00	1	000900811
16x18	235	113,00	1	000900812
17x19	250	116,00	1	000900814
18x19	265	128,00	1	000900815
19x22	280	135,00	1	000900817
20x22	295	153,00	1	000900818
21x23	298	161,00	1	000900820
22x24	315	195,00	1	000900821
24x26	333	251,00	1	000900822
24x27	340	251,00	1	000900823
30x32	395	369,00	1	000900824
34x36	410	525,00	1	000900826
*36x41	450	710,00	1	000900828
*41x46	470	870,00	1	000900829
*46x50	490	965,00	1	000900830

## 91BA

chave de luneta anti-faísca para trabalhos pesados



mm	Ø mm	€		
24	38	303,00	1	000910824
27	42	361,00	1	000910827
30	48	413,00	1	000910830
32	49	462,00	1	000910832
36	54	505,00	1	000910836
41	62	565,00	1	000910841
*46	69	745,00	1	000910846
*50	75	800,00	1	000910850
*55	82	920,00	1	000910855

## 92BA

tubo anti-faísca para ref. 91BA



	L mm	91BA mm	Ø mm	€		
92BA/1	460	24÷30	25	357,00	1	000920810
92BA/2	610	32÷41	28	462,00	1	000920820
*92BA/3	760	46÷55	32	620,00	1	000920830

## 93BA

chave de lunetas para parafusos para andaimes, anti-faísca



mm	L mm	€		
21x22	345	745,00	1	000930821

## 95BA

chave de lunetas direitas, anti-faísca



mm	L mm	€		
7x9	115	45,00	1	000950801
8x10	115	50,50	1	000950802
10x11	140	55,50	1	000950804
10x12	140	66,00	1	000950805
12x14	145	75,00	1	000950806
14x17	165	90,00	1	000950807
*16x18	170	117,00	1	000950809
*17x19	185	102,00	1	000950808
*18x19	185	128,00	1	000950810
*19x22	200	159,00	1	000950812
*21x23	230	176,00	1	000950815
*24x27	255	224,00	1	000950817
*30x32	295	337,00	1	000950820

## 96BA

chave sextavada anti-faísca



mm	L mm	L1 mm	€		
1,5	50	17	93,00	1	000960760
2	50	16	95,00	1	000960762
2,5	56	20	102,00	1	000960761
3	63	21	103,00	1	000960763
4	69	25	109,00	1	000960764
5	78	29	113,00	1	000960765
6	88	33	115,00	1	000960766
7	93	34	121,00	1	000960767
8	97	36	128,00	1	000960768
9	104	37	134,00	1	000960769
10	110	39	139,00	1	000960770
11	118	42	147,00	1	000960771
12	122	44	169,00	1	000960772
14	150	58	188,00	1	000960774
15	156	60	199,00	1	000960775
16	162	63	218,00	1	000960776
17	168	65	229,00	1	000960777
19	177	72	256,00	1	000960779
22	186	77	299,00	1	000960802
24	192	82	346,00	1	000960804

## 96BA/BP

chave sextavada ponta de bola, anti-faísca



mm	L mm	L1 mm	€		
1,5	50	16	95,50	1	000961800
2	50	16	96,00	1	000961801
2,5	63	20	109,00	1	000961802
3	60	20	109,00	1	000961803
3,5	70	25	114,00	1	000961799
4	66	25	114,00	1	000961804
5	75	28	116,00	1	000961805
6	84	32	120,00	1	000961806
8	92	36	131,00	1	000961808
10	102	40	141,00	1	000961810
12	113	45	174,00	1	000961812



## 96BAF-AS

chaves sextavadas antifaísca



mm	L mm	L1 mm	€	1	000962831
*1/16	59	25	75,00	1	000962831
*5/64	59	25	78,00	1	000962832
*3/32	59	25	81,00	1	000962833
*7/64	59	25	84,50	1	000962834
*1/8	59	25	87,50	1	000962835
*9/64	64	29	95,00	1	000962836
*5/32	65	30	97,50	1	000962837
*3/16	79	31	103,00	1	000962838
*7/32	85	37	108,00	1	000962839
*1/4	85	37	113,00	1	000962840
9/32	88	38	116,00	1	000962841
*5/16	92	44	122,00	1	000962842
11/32	100	44	125,00	1	000962843
*3/8	110	45	132,00	1	000962844
*7/16	119	48	141,00	1	000962845
*1/2	140	55	172,00	1	000962846
*9/16	150	58	198,00	1	000962847

## 330BA/2R

cavilha e canivete de substituição para corta-tubos anti-faísca 330BA para tubos de gás



330BA/2-R	€	1	003300822
	96,00	1	003300822

## 363BA

chave para tubos anti-faísca para trabalhos pesados



L mm	Ø max mm	Ø max mm	€	1	003630815
150	1/2" gas	20	309,00	1	003630815
200	1" gas	30	310,00	1	003630820
250	1"1/2 gas	49	361,00	1	003630825
300	2" gas	60	459,00	1	003630830
350	2" gas	60	570,00	1	003630835
450	2"1/2 gas	76	865,00	1	003630845
600	3" gas	90	1.200,00	1	003630860

## 378BA

chave de tubos anti-faísca, modelo sueco, em liga de cobre-berílio



L mm	Ø max mm	€	1	003780800
430	1" 1/2 gas	940,00	1	003780800
530	2" gas	1.160,00	1	003780801

## 386BA

chave de corrente para tubos anti-faísca reversível, para trabalhos pesados

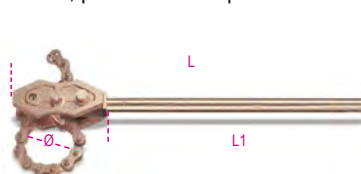

L mm	Ø max mm	470	€	1	003860806
600	100	470	1.420,00	1	003860806
900	200	750	2.350,00	1	003860809

## 911BA

chave de caixa bisextavada anti-faísca

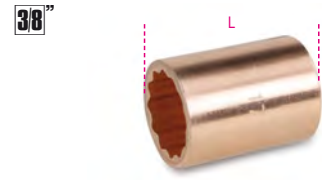

mm	L mm	€	1	009110806
6	28	63,00	1	009110806
7	28	67,00	1	009110807
8	28	72,00	1	009110808
9	28	76,50	1	009110809
10	32	104,00	1	009110810
11	32	110,00	1	009110811
12	32	116,00	1	009110812
13	32	121,00	1	009110813
14	32	129,00	1	009110814
15	32	130,00	1	009110815
16	32	136,00	1	009110816
17	32	141,00	1	009110817
18	32	143,00	1	009110818
19	32	148,00	1	009110819

## 911BA/16

adaptador, quadras fêmea 3/8" e macho 1/2", anti-faísca

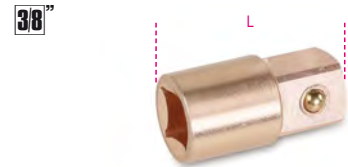

L mm	3/8	1/2	€	1	009110836
34	3/8	1/2	132,00	1	009110836

## 911BA/20

Extensão com quadras macho e fêmea de 1/2", anti-faísca



L mm	€	1	009110840
75	107,00	1	009110840

## 911BA/55

roquete anti-faísca, quadra 3/8"

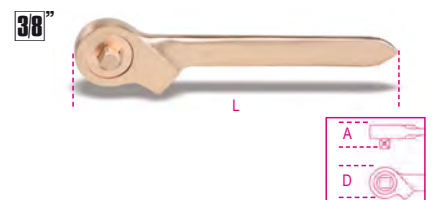

L mm	D mm	A mm	€	1	009110882
200	45	16.5	227,00	1	009110882

## 99BA

chave de gancho anti-faísca, para porcas ranhuradas UNI/ISO 2982, 2983



mm	A mm	€	1	000990803
32-75	4,0	245,00	1	000990803
50-120	4,5	384,00	1	000990805
115-170	4,5	620,00	1	000990811

## 110BA

chave ajustável anti-faísca



L mm	A max mm	€	1	001100810
100	13	181,00	1	001100810
150	18	208,00	1	001100815
200	24	245,00	1	001100820
250	30	295,00	1	001100825
300	36	414,00	1	001100830
375	46	560,00	1	001100837
*450	55	785,00	1	001100845
*600	65	1.310,00	1	001100860

## 330BA

corta tubos anti-faísca para tubos de gás



330BA/2	Ø max 50 mm	L mm 375	€	1	003300802
	2"		955,00	1	003300802



## 921BA

chave de caixa bisextavada anti-faísca

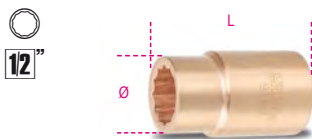

mm	Ø mm	L mm	€		
8	15,0	40	94,50	1	009210808
9	16,0	40	99,00	1	009210809
10	17,5	40	114,00	1	009210810
11	18,0	40	117,00	1	009210811
12	18,5	40	125,00	1	009210812
13	20,0	40	132,00	1	009210813
14	21,0	40	135,00	1	009210814
15	21,5	40	140,00	1	009210815
16	24,0	40	144,00	1	009210816
17	25,0	40	149,00	1	009210817
18	25,0	40	156,00	1	009210818
19	28,0	42	160,00	1	009210819
20	29,0	42	169,00	1	009210820
21	30,0	43	171,00	1	009210821
22	30,5	43	178,00	1	009210822
24	34,0	43	209,00	1	009210824
25	36,0	43	227,00	1	009210825
26	37,5	43	243,00	1	009210826
27	37,5	45	254,00	1	009210827
28	38,9	46	265,00	1	009210828
30	41,5	46	298,00	1	009210830
32	43,5	46	329,00	1	009210832

## 921BA-AS

Chave de caixa bisextavada anti-faísca

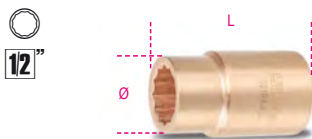

"	Ø mm	L mm	€		
5/16	24,0	40	101,00	1	009210958
3/8	24,0	40	109,00	1	009210960
7/16	24,0	40	118,00	1	009210961
1/2	24,0	40	126,00	1	009210963
9/16	24,0	40	132,00	1	009210964
5/8	25,0	40	149,00	1	009210966
11/16	25,5	40	161,00	1	009210967
3/4	28,0	42	178,00	1	009210969
13/16	30,0	43	188,00	1	009210971
7/8	31,5	43	206,00	1	009210972
15/16	34,0	43	217,00	1	009210974
1	36,0	43	243,00	1	009210975
1.1/16	38,0	46	260,00	1	009210977
1.1/4	42,0	46	346,00	1	009210982
1.7/16	50,5	50	426,00	1	009210986

## 921BA/15

adaptador, quadras fêmea 1/2" e macho 3/8", anti-faísca



L mm	□	■	€		
34	1/2	3/8	119,00	1	009210839

## 921BA/16

adaptador, encabadouro 1/2" fêmea e 3/4" macho, antifaísca

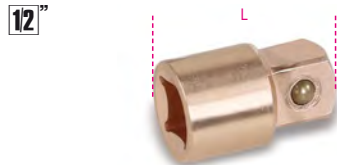

L mm	□	■	€		
34	1/2	3/4	157,00	1	009210840

## 921BA/21 - 921BA/22

extensão anti-faísca com encabadouro 1/2"



	L mm	Ø mm	€		
921BA/21	125	30	159,00	1	009210842
921BA/22	250	31	222,00	1	009210844

## 921BA/25

cardan anti-faísca com quadras macho e fêmea de 1/2"



L mm	Ø mm	□	■	€		
80	25	1/2	1/2	161,00	1	009210845

## 921BA/42

punho em T anti-faísca encabadouro 1/2"

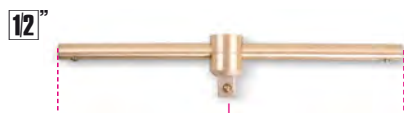

L mm	€		
250	262,00	1	009210846

## 921BA/50

roquete anti-faísca encabadouro quadrado 1/2"



L mm	D mm	A mm	€		
250	45	16,5	303,00	1	009210850

## 921BA/R50

quadra de substituição para roquete anti-faísca



12"	€		
	90,00	1	009210851

## 926BA

chave de caixa anti-faísca bi-sextavada

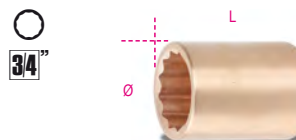

mm	Ø mm	L mm	€		
22	40	55	198,00	1	009260822
24	40	55	221,00	1	009260824
26	40	55	251,00	1	009260826
27	40	55	265,00	1	009260827
28	41	55	310,00	1	009260828
30	43	60	317,00	1	009260830
32	45	60	354,00	1	009260832
34	48	60	376,00	1	009260834
36	50	60	408,00	1	009260836
38	53	60	435,00	1	009260838
41	57	65	477,00	1	009260841
46	63	65	570,00	1	009260846
50	68	70	625,00	1	009260850

## 926BA/15

adaptador, encabadouro 3/4" fêmea e 1/2" macho, antifaísca



L mm	□	■	€		
55	3/4	1/2	157,00	1	009260861

## 926BA/22

extensão anti-faísca com encabadouro 3/4"



	L mm	Ø mm	€		
926BA/22	200	38	317,00	1	009260872

## 926BA/42

punho em T anti-faísca encabadouro 3/4"



L mm	€		
400	459,00	1	009260876

## 926BA/50

roquete reversível anti-faísca encabadouro 3/4"



L mm	D mm	A mm	€	🔧	📄
300	61	22	470,00	1	009260880

## 926BA/R50

quadra de substituição para roquete anti-faísca



3/4"	€	🔧	📄
149,00	1	009260881	

## 937BA

chave de cachimbo sextavada, anti-faísca



Ø mm	L mm	A mm	€	🔧	📄
13	240	45	117,00	1	009370813
17	260	51	170,00	1	009370817
19	270	55	177,00	1	009370819
22	278	59	232,00	1	009370822
24	286	63	248,00	1	009370824
27	294	69	263,00	1	009370827
30	302	75	291,00	1	009370830
32	310	81	317,00	1	009370832
★36	330	85	373,00	1	009370836
★41	350	90	450,00	1	009370841

## 951BA

Chaves sextavadas macho com punho em T, antifaísca



mm	L mm	L1 mm	€	🔧	📄
4	100	90	198,00	1	009510904
5	100	90	207,00	1	009510905
6	100	90	218,00	1	009510906

## 961BA

Alavanca anti-faísca



L mm	A mm	€	🔧	📄
250	39	174,00	1	009610802
350	55	262,00	1	009610806

## 963BA

alavancas anti-faísca com uma extremidade aguçada e outra plana



L mm	A mm	€	🔧	📄
500	24	486,00	1	009630801
★800	24	765,00	1	009630803
★1000	30	1.610,00	1	009630805

## 964BA

chave para tampões anti-faísca



L mm	€	🔧	📄
385	459,00	1	009640801

## 964BA/L

chave universal para tampões; anti-faísca

Para abrir tampões em metal



★964BA/L	L mm	€	🔧	📄
	510	2.320,00	1	009640821

## 965BA

chave para válvulas de segurança, anti-faísca



A mm	A1 mm	L mm	€	🔧	📄
30	44	200	201,00	1	009650830
32	50	300	281,00	1	009650832
35	47	250	229,00	1	009650835
40	50	300	263,00	1	009650840
45	58	350	340,00	1	009650845
48	62	375	354,00	1	009650848
50	67	400	388,00	1	009650850
55	73	450	465,00	1	009650855
60	79	500	505,00	1	009650860
★65	82	550	565,00	1	009650865
★70	85	600	620,00	1	009650870

## 966BA

chave de válvulas de segurança anti-faísca

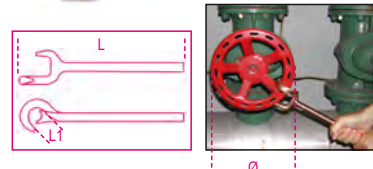

L mm	L1 mm	Ø min+max mm	€	🔧	📄
350	40	50=150	440,00	1	009660801

## 966BA/V

chaves válvula de segurança anti-faísca

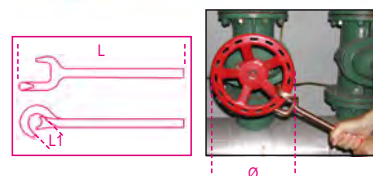

L mm	L1 mm	Ø min+max mm	€	🔧	📄
370	36	125=250	440,00	1	009660812
430	48	250=400	635,00	1	009660814

## 1032BA

alicate anti-faísca com circlip interno, plano, pegas revestimento em PVC



L mm	Ø mm	€	🔧	📄
200	40=100	287,00	1	010320820

## 1036BA

alicate anti-faísca com circlip externo, plano, pegas revestimento em PVC



L mm	Ø mm	€	🔧	📄
200	40=100	287,00	1	010360820



**1046BA**  
alicate anti-faísca

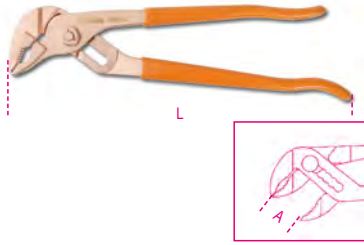

L mm	A max mm	€		
250	32	375,00	1	010460801
★300	52	494,00	1	010460803

**1052BA**  
Alicate de pressão, maxilas côncavas, anti-faísca

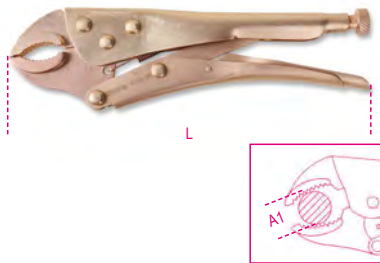

L mm	A1 max mm	€		
225	40,0	369,00	1	010520824

**1082BA**  
alicate de corte diagonal anti-faísca

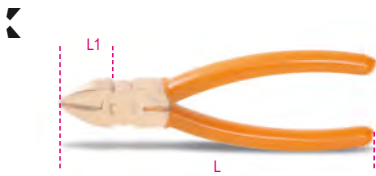

L mm	L1 mm	€		
160	22	268,00	1	010820801

**1100BA**  
corta parafusos, anti-faísca



L mm	€		
600	1.920,00	1	011000860

**1137BA**  
alicate de cravagem



L mm	L1 mm	€		
185	30	499,00	1	011370801

**1137BA/RC**  
mordente sobresselente para ref. 1137BA



1137BA/RC	€		
	96,00	1	011370851

**1150BA**  
alicate universal anti-faísca

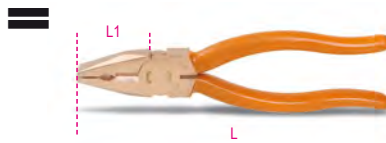

L mm	L1 mm	€		
200	40	316,00	1	011500820

**1162BA**  
alicate de pontas planas extra-longas anti-faísca



L mm	L1 mm	€		
150	54	248,00	1	011620815

**1166BA**  
alicate de pontas semi-redondas extra-longas anti-faísca



L mm	L1 mm	€		
150	54	248,00	1	011660815

**1270BA**  
chave de fendas anti-faísca



AxL mm	L1 mm	€		
3x75	178	45,00	1	012700803
4x100	209	55,50	1	012700804
5x150	250	74,00	1	012700805
6x150	270	78,50	1	012700806
8x200	312	89,00	1	012700808
10x250	382	119,00	1	012700810

**1272BA**  
chave de fendas anti-faísca para parafusos Phillips®



PHxDxL mm	L1 mm	€		
1x5x100	209	62,50	1	012720801
2x6x150	270	79,50	1	012720802
3x8x200	332	95,50	1	012720803

**1277BA**  
chaves de fendas para parafusos de perfil Torx®, antifaísca



Ø	L mm	L1 mm	Ø mm	€		
T10	75	184	5	59,00	1	012770810
T15	75	184	5	64,00	1	012770815
T20	100	209	6	86,50	1	012770820
T25	125	209	6	91,50	1	012770825
T30	150	270	6	101,00	1	012770830
T40	200	332	8	133,00	1	012770840

**1370BA**  
martelo para mecânico anti-faísca, cabo em madeira



g	A mm	L mm	L1 mm	€		
500	30	310	108	166,00	1	013700805
1000	35	340	137	292,00	1	013700810

## 1370BA/MR

cabo de substituição para ref. 1370BA

	€	1	013700865
1370BA/MR 500	28,00	1	013700865
1370BA/500			
1370BA/MR 1000	34,00	1	013700870
1370BA/1000			

## 1370BA/PL

martelos para mecânico antifaisca, cabo em fibra



g	A mm	L mm	L1 mm	€	1	013700815
500	30	310	108	166,00	1	013700815
1000	35	340	137	292,00	1	013700820

## 1375BA/PL

martelo de orelhas anti-faisca, cabo em fibra



g	L mm	L1 mm	Ø mm	€	1	013750800
680	321	125	30	213,00	1	013750800

## 1377BA

martelo de bola anti-faisca, cabeça redonda, para trabalhos em cobre e latão



g	L1 mm	L mm	€	1	013770834
340	90	280	107,00	1	013770834

## 1377BA/PL

martelo de bola anti-faisca, cabeça redonda, para trabalhos em cobre e latão



g	L1 mm	L mm	€	1	013770884
340	90	280	107,00	1	013770884

## 1379BA

martelo picador anti-faisca, cabo em madeira



g	L1 mm	L mm	€	1	013790850
500	142	315	207,00	1	013790850

## 1380BA

maço anti-faisca, cabo em madeira



g	L1 mm	L mm	€	1	013800810
1000	100	400	357,00	1	013800810
1500	118	400	435,00	1	013800815
2000	126	400	575,00	1	013800820

## 1380BA/MR

cabo de substituição para ref. 1380BA

	€	1	013800860
1380BA/MR 1000	36,00	1	013800860
1380BA/1000			
1380BA/MR 1500	36,00	1	013800865
1380BA/1500			
1380BA/MR 2000	36,00	1	013800870
1380BA/2000			

## 1380BA/PL

marretas antifaisca, cabo em fibra



g	L1 mm	L mm	€	1	013800955
500	80	310	178,00	1	013800955
1000	94	350	332,00	1	013800960
1500	115	400	477,00	1	013800965
2000	125,5	400	625,00	1	013800970

## 1381BA

martelos anti-faisca, cabos em madeira



g	L1 mm	L mm	€	1	013810850
5000	179	900	1.340,00	1	013810850
*8000	190	900	2.140,00	1	013810858

## 1381BA/MR

cabo de substituição para ref. 1381BA

	€	1	013810870
1381BA/MR 5000	55,50	1	013810870
1381BA/5000			
*1381BA/MR 8000	64,50	1	013810878
1381BA/8000			

## 1381BA/PL

marretas antifaisca, cabo em fibra



g	L1 mm	L mm	€	1	013810885
5000	172	900	1.230,00	1	013810885
8000	204	900	2.200,00	1	013810888

## 1390BA

martelo anti-faisca com superfície de contacto macia



Ø mm	L mm	L1 mm	€	1	013900805
*52	370	130	287,00	1	013900805

## 1390BA/R

batentes sobresselentes em nylon para artigo 1390BA



D mm	€	4	013900885
52	58,00	4	013900885



## 1602BA

alicate para cravar terminais anti-faísca para terminais isolados, série ligeira



mm <sup>2</sup>	L mm	€	1	016020801
0.75+6	200	353,00	1	016020801

## 1701BA

escopros sextavados anti-faísca



L mm	A mm	S mm	€	1	017010810
150	12	10	65,00	1	017010810
200	16	14	104,00	1	017010814
250	18	14	128,00	1	017010815
350	19	17	337,00	1	017010817

## 1703BA/A

machado anti-faísca



L mm	L1 mm	A mm	€	1	017030082
340	145	82	292,00	1	017030082

## 1703BA/P

picareta anti-faísca

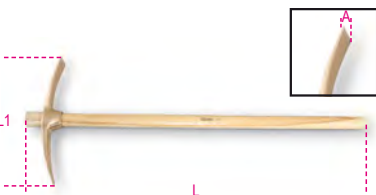

A mm	L mm	L1 mm	€	1	017030150
56	1050	410	765,00	1	017030150

## 1703BA/PL

pá anti-faísca



A mm	L1 mm	L mm	€	1	017030200
240	420	990	645,00	1	017030200

## 1717BA

espátula rígida anti-faísca



A mm	€	1	017170801
60	157,00	1	017170801
80	174,00	1	017170803

## 1717BA/1

raspador anti-faísca



A mm	L mm	€	1	017170805
100	220	314,00	1	017170805

## 1719BA8

limas 8" anti-faísca



	L mm	€	1	017190801
1719BA8/P	200	192,00	1	017190801
1719BA8/M	200	199,00	1	017190805
1719BA8/R	200	203,00	1	017190810
1719BA8/T	200	187,00	1	017190815
1719BA8/Q	200	187,00	1	017190820

## 1719BA12

limas 12" anti-faísca



	L mm	€	1	017190831
1719BA12/P	300	346,00	1	017190831

## 1727BA

serrote e folha anti-faísca



L mm	L1 mm	€	1	017270801
500	300	615,00	1	017270801

## 1728BA

lâminas anti-faísca para serrotes, em liga de cobre-berílio



L mm	€	1	017280801
300	119,00	1	017280801

## 1737BA

escova de arame anti-faísca



L mm	A mm	€	1	017370801
294	29	79,50	1	017370801

## 1758BA

funil antifaísca



Ø mm	H mm	€	1	017580815
160	150	111,00	1	017580815

## 1776BA

navalha anti-faísca



L1 mm	L mm	€	1	017760801
145	250	172,00	1	017760801

## 1784BA

tesoura anti-faísca



L mm	€	1	017840822
225	298,00	1	017840822







# FERRAMENTAS ELÉTRICAS

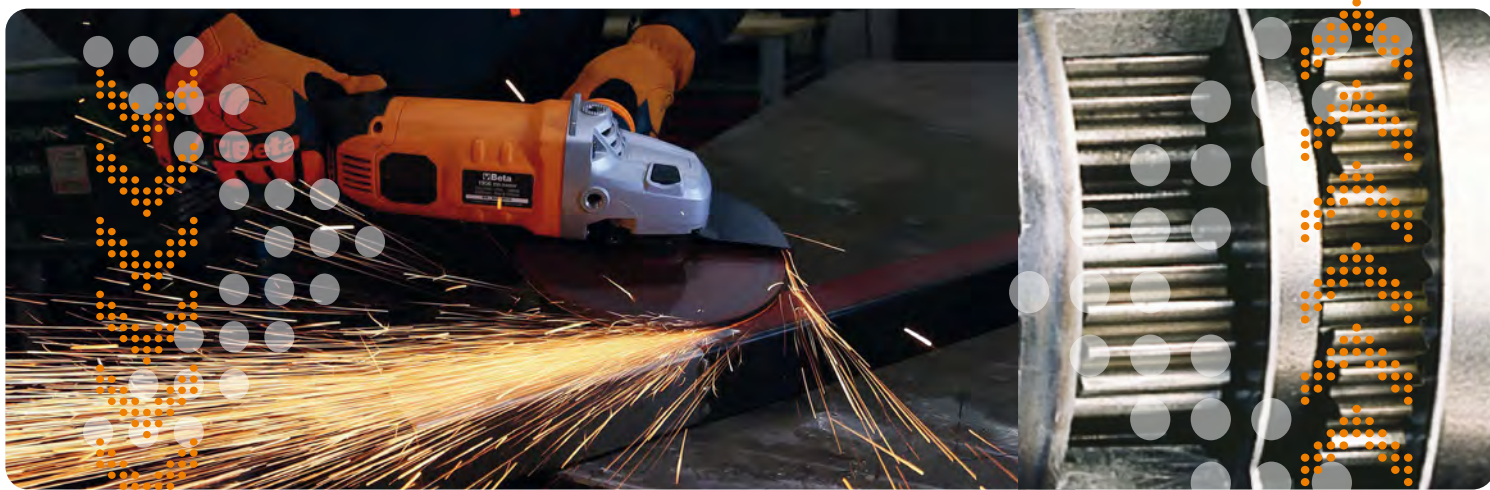

Instrumentos de trabalho fiáveis e duradouros, capazes de satisfazer as exigências de cada profissional.

A família de ferramentas elétricas da Beta inclui

- FERRAMENTAS A BATERIA
- FERRAMENTAS COM FIO

 **Beta**  
**POWERTOOLS**



## FERRAMENTAS A BATERIA

 **3-YEAR WARRANTY**



A nova gama de ferramentas a bateria inclui máquinas de alto desempenho de 12V e 20V.

A **linha 12V** inclui a aparafusadora e a chave de impacto, ferramentas indispensáveis concebidas para facilitar o trabalho diário, baseadas em desempenho, leveza e dimensões compactas.

Já a **linha 20V** é composta por ferramentas a bateria, sinónimo de **alto desempenho, qualidade de construção e durabilidade**.

Na Beta confiamos nessas características para desenvolver uma linha abrangente de ferramentas a bateria, desde a aparafusadora de binário elevado até à chave de impacto com quadra de 1/2".

Todas as novas ferramentas elétricas Beta estão equipadas com motores sem escovas e mecanismos interiores de qualidade, para melhorar significativamente o desempenho e a durabilidade da ferramenta.

A chave de impacto com um binário máximo de desaparafusamento de 1200 Nm é sem dúvida a principal ferramenta elétrica da nova linha, um parceiro de trabalho ideal para quem precisa de potência e desempenho incomparáveis.

As nossas baterias de íões de lítio de 20V estão disponíveis com capacidades até 6Ah e podem ser usadas em todas as ferramentas da linha.



Digitalize o código QR para mais informações sobre a extensão gratuita da garantia de 3 anos.

## 1972/K12V-10

aparafusadora ultracompacta, 12V

- ultracompacta: comprimento máximo de 170 mm; ultraleve: não mais de 1,1 kg, com bateria e perfeitamente equilibrada
- velocidade mecânica dupla com engrenagens de aço e embraiagem de 20 posições
- binário até 30 Nm e 1300 rpm (400 rpm na 1ª velocidade); fura diâmetros até 10 mm em aço e 20 mm em madeira
- Baterias de 2Ah e indicador de carga no corpo da máquina
- punho ergonómico antiderrapante
- LED frontal
- bucha automática de 10 mm
- clipe para cinto (lado direito/esquerdo)
- botão seletor, modos de aparafusar-desaparafusar-bloqueio (para transporte)
- fornecido em mala rígida com 2 baterias de íões de lítio (2 Ah) e carregador rápido (50 min)

1972/K12V-10

316x254x96 mm - 2,3 kg

€ 287,00



1



019720112

Beta  
3-YEAR  
WARRANTY



CE

## 1982/K12V

chave de impacto reversível, 12V,

ideal para trabalhos em áreas pequenas, com binário elevado (80 Nm), operação com uma mão

- ultracompacta: comprimento máximo de 160 mm; ultraleve: não mais de 1 kg, com bateria, e perfeitamente equilibrada
- encabadouro sextavado 1/4" com porca de bloqueio
- clipe para cinto (lado direito/esquerdo)
- LED frontal
- botão seletor, modos de aparafusar-desaparafusar-bloqueio (para transporte)
- punho ergonómico antiderrapante
- caixa de engrenagens inteiramente em metal
- baterias 2Ah com indicador de carga no corpo da máquina
- fornecido em mala rígida com 2 baterias de íões de lítio (2 Ah) e carregador rápido (50 min)

1982/K12V

316x254x96 mm - 2,3 kg

€ 287,00



1



019820112

Beta  
3-YEAR  
WARRANTY



CE

## 1972/K12V-COMBO

kit aparafusadora 12V ultracompacta + chave de impacto reversível encabadouro sextavado 1/4"

Inclui:

- 1 aparafusadora ultracompacta 12V, com bucha automática de 10 mm
- 1 chave de impacto reversível 12V, com encabadouro sextavado 1/4"
- 2 baterias de íões de lítio 2Ah
- 1 carregador rápido

1972/K12V-COMBO

310x295x100 mm - 3 kg

€ 488,00



1



019720010



Beta  
3-YEAR  
WARRANTY



1972/K12V-10

+



1982/K12V

CE



## 1972/12V-10

aparafusadora ultracompacta, 12V (sem baterias e sem carregador)

- Ultracompacta - comprimento máximo de 170 mm; ultraleve - não mais de 1.1 kg, com bateria e perfeitamente equilibrada
- Bucha automática de 10 mm
- Binário até 30 Nm e 1300 rpm (400 rpm na 1ª velocidade); fura diâmetros até 10 mm em aço e 20 mm em madeira
- Velocidade mecânica dupla com engrenagens em aço (0-400/1300 rpm)
- Embraiagem de 20 posições
- Botão seletor, modos de aparafusar-desaparafusar-bloqueio (para transporte)
- LED frontal
- Punho ergonómico antiderrapante
- Clipe para cinto (lado esquerdo/direito)

790 g

1972/12V-10

€ 119,00 1 019720113

Beta  
3-YEAR  
WARRANTY



0-400/min  
0-1300/min  
30 Nm



CE

## 1982/12V

chave de impacto reversível, 12V (sem baterias e sem carregador)

Ideal para trabalhos em áreas reduzidas, binário elevado (80 Nm); operação com uma mão

- ultracompacta - comprimento máximo de 160 mm; ultraleve - não mais de 1 kg, com bateria e perfeitamente equilibrada
- encadouro sextavado 1/4", com porca de bloqueio
- clipe para cinto (lado direito/esquerdo)
- LED frontal
- botão seletor, modos de aparafusar-desaparafusar-bloqueio (para transporte)
- punho ergonómico antiderrapante
- caixa de engrenagens inteiramente em metal

800 g

1982/12V

€ 127,00 1 019820113

Beta  
3-YEAR  
WARRANTY



LED  
80 Nm



CE

## 1994BL 12V-2Ah

bateria de íões de lítio 2Ah, 12V

Características principais

- Voltagem da bateria: 12V
- Capacidade da bateria: 2Ah
- Capacidade energética: 24Wh
- Tipo de bateria: Li-ion

170 g

1994BL 12V-2Ah

€ 53,50 1 019940015



CE

## 1994CB 12V

carregador rápido, 12V, 110V-240V

Características principais:

- Indicador LED de nível de carga
- Voltagem nominal de entrada: 110V-240V ~ 50/60Hz
- Voltagem de saída: 12.6V
- Corrente de carga: 2A
- Potência nominal de entrada: 35W
- Tempo de carregamento da bateria 2Ah: 50 min

260 g

1994CB 12V

€ 53,50 1 019940123



CE



## 1972/K20V-13BMC

kit berbequim de percussão, 20V, BRUSHLESS

• Motor brushless

Desempenho significativamente melhorado: maior potência, redução do consumo de energia, vida útil prolongada do motor, fornecimento de energia melhorado do botão

- 3 modos de funcionamento: furar, aparafusar e furar com percussão
- Compacto: comprimento máximo de 210 mm
- Punho ergonómico antiderrapante
- Botão seletor, modos de aparafusar-desaparafusar-bloqueio (para transporte)
- Caixa de engrenagens inteiramente em metal
- Luz LED integrada para trabalhar em condições de pouca visibilidade
- Clipe para cinto (lado direito/esquerdo)
- Punho lateral adicional para trabalhos de binário elevado
- Fornecido em mala rígida com 2 baterias de íões de lítio (4 Ah) e carregador rápido

Características principais:

- Binário máx.: 80 Nm
- Impactos por minuto na 1a Velocidade 0 – 6750 (BPM)
- Impactos por minuto na 2a Velocidade 0 – 24000 (BPM)
- 20 posições de ajuste do binário
- Bucha automática de 13 mm
- Velocidade mecânica dupla com engrenagens em aço (0-450/1650 rpm)
- Diâmetro máx. de perfuração em madeira: 55 mm
- Diâmetro máx. de perfuração em metal: 13 mm
- Diâmetro máx. de perfuração em alvenaria: 13 mm

**Beta**  
3-YEAR  
WARRANTY



1972/K20V-13BMC

€ 625,00 1 019720020

490x370x125 mm - 5,5 kg

## 1972/20V-13BMC

berbequim de percussão, 20V, BRUSHLESS (sem baterias e sem carregador)

• Motor brushless

Desempenho significativamente melhorado: maior potência, redução do consumo de energia, vida útil prolongada do motor, fornecimento de energia melhorado do botão

- 3 modos de funcionamento: furar, aparafusar e furar com percussão
- Compacto: comprimento máximo de 210 mm
- Punho ergonómico antiderrapante
- Botão seletor, modos de aparafusar-desaparafusar-bloqueio (para transporte)
- Caixa de engrenagens inteiramente em metal
- Luz LED integrada para trabalhar em condições de pouca visibilidade
- Clipe para cinto (lado direito/esquerdo)
- Punho lateral adicional para trabalhos de binário elevado
- Fornecido em mala rígida, sem baterias e sem carregador

Características principais:

- Binário máx.: 80 Nm
- Impactos por minuto na 1a Velocidade 0 – 6750 (BPM)
- Impactos por minuto na 2a Velocidade 0 – 24000 (BPM)
- 20 posições de ajuste do binário
- Bucha automática de 13 mm
- Velocidade mecânica dupla com engrenagens em aço (0-450/1650 rpm)
- Diâmetro máx. de perfuração em madeira: 55 mm
- Diâmetro máx. de perfuração em metal: 13 mm
- Diâmetro máx. de perfuração em alvenaria: 13 mm

**Beta**  
3-YEAR  
WARRANTY



1972/20V-13BMC

€ 257,00 1 019720019

490x370x125 mm - 3,6 kg

## 1984/K600

chave de impacto reversível, 20 V, sem escovas, encabadouro 1/2" - 600 Nm

- 3 ajustes de binário e rpm no modo de aparafusar
- Binário de desaperto até 600 Nm

### • Motor BRUSHLESS

Desempenho significativamente melhorado: maior potência, redução do consumo de energia, vida útil prolongada do motor, fornecimento de energia melhorado do botão

- Encabadouro quadra 1/2" com anel de retenção
- Impactos por minuto 0-2.300 (BPM)
- Caixa de engrenagens inteiramente em metal
- Punho ergonómico antiderrapante
- Botão seletor, modos de aparafusar-desaparafusar-bloqueio (para transporte)
- Luz LED integrada para trabalhar em condições de pouca visibilidade
- Clipe para cinto (lado direito/esquerdo)

### Aperto

3 ajustes de binário e rpm (baixo - médio - alto):

- 1: 200 Nm; 1000 rpm
- 2: 350 Nm; 1500 rpm
- 3: 550 Nm; 1800 rpm

### Desaperto

- 1: 600 Nm: a chave de impacto aplica o binário máximo sem parar (desaperto livre)
- 2: 600 Nm - Autostop: a chave de impacto aplica o binário máximo até a porca estar totalmente desapertada e para automaticamente (desaperto por impacto único)

Fornecida em prático estojo rígido completo com 2 baterias de lítio ion (4 Ah) e carregador rápido.



1984/K600

€ 720,00 1 019840060

490x370x125 mm - 6,3 kg

## 1984 20V/600BMC

chave de impacto reversível, 20V, BRUSHLESS, com encabadouro 1/2" - 600 Nm (sem baterias e sem carregador)

- 3 ajustes de binário e rpm no modo de aparafusar
- Binário de desaperto até 600 Nm

### • Motor BRUSHLESS

Desempenho significativamente melhorado: maior potência, redução do consumo de energia, vida útil prolongada do motor, fornecimento de energia melhorado do botão

- Encabadouro quadra 1/2" com anel de retenção
- Impactos por minuto 0-2.300 (BPM)
- Caixa de engrenagens inteiramente em metal
- Punho ergonómico antiderrapante
- Botão seletor, modos de aparafusar-desaparafusar-bloqueio (para transporte)
- Luz LED integrada para trabalhar em condições de pouca visibilidade
- Clipe para cinto (lado direito/esquerdo)

- **Fornecido em mala rígida, sem baterias e sem carregador**

### Aperto

3 ajustes de binário e rpm (baixo - médio - alto):

- 1: 200 Nm; 1000 rpm
- 2: 350 Nm; 1500 rpm
- 3: 550 Nm; 1800 rpm

### Desaperto

- 1: 600 Nm: a chave de impacto aplica o binário máximo sem parar (desaperto livre)
- 2: 600 Nm - Autostop: a chave de impacto aplica o binário máximo até a porca estar totalmente desapertada e para automaticamente (desaperto por impacto único)

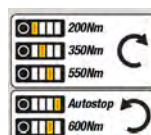

1984 20V/600BMC

€ 351,00 1 019840907

490x370x125 mm - 4,4 kg

## 1984/K1200

chave de impacto reversível, 20 V, sem escovas, encabadouro 1/2" - 1200 Nm

CE

Ideal para aplicações que exigem binário elevado.

- 3 ajustes de binário e rpm no modo de aparafusar
- Binário de desaperto até 1200 Nm
- Binário máximo até 1700 Nm

### • Motor BRUSHLESS

Desempenho significativamente melhorado: maior potência, redução do consumo de energia, vida útil prolongada do motor, fornecimento de energia melhorado do botão

- Encabadouro quadra 1/2" com anel de retenção
- Impactos por minuto 0-2.200 (BPM)
- Caixa de engrenagens inteiramente em metal
- Punho ergonômico antiderrapante
- Botão seletor, modos de aparafusar-desaparafusar-bloqueio (para transporte)
- Luz LED integrada para trabalhar em condições de pouca visibilidade
- Clipe para cinto (lado direito/esquerdo)

### Aperto

3 ajustes de binário e rpm (baixo - médio - alto):

- 1: 350 Nm; 800 rpm
- 2: 600 Nm; 1400 rpm
- 3: 900 Nm; 1600 rpm

### Desaperto

- 1: 1200 Nm: a chave de impacto aplica o binário máximo sem parar (desaperto livre)
- 2: 1200 Nm - Autostop: a chave de impacto aplica o binário máximo até a porca estar totalmente desapertada e para automaticamente (desaperto por impacto único)

Fornecida em prático estojo rígido completo com 2 baterias de lítio ion (6 Ah) e carregador rápido.



1984/K1200

€ 870,00 1 019840120

490x370x125 mm - 7 kg

## 1984 20V/1200BMC

chave de impacto reversível, 20V, BRUSHLESS, com encabadouro 1/2" - 1200 Nm (sem baterias e sem carregador)

CE

Ideal para aplicações que exigem binário elevado.

- 3 ajustes de binário e rpm no modo de aparafusar
- Binário de desaperto até 1200 Nm
- Binário máximo até 1700 Nm

### • Motor BRUSHLESS

Desempenho significativamente melhorado: maior potência, redução do consumo de energia, vida útil prolongada do motor, fornecimento de energia melhorado do botão

- Encabadouro quadra 1/2" com anel de retenção
- Impactos por minuto 0-2.200 (BPM)
- Caixa de engrenagens inteiramente em metal
- Punho ergonômico antiderrapante
- Botão seletor, modos de aparafusar-desaparafusar-bloqueio (para transporte)
- Luz LED integrada para trabalhar em condições de pouca visibilidade
- Clipe para cinto (lado direito/esquerdo)
- Fornecido em mala rígida, sem baterias e sem carregador

### Aperto

3 ajustes de binário e rpm (baixo - médio - alto):

- 1: 350 Nm; 800 rpm
- 2: 600 Nm; 1400 rpm
- 3: 900 Nm; 1600 rpm

### Desaperto

- 1: 1200 Nm: a chave de impacto aplica o binário máximo sem parar (desaperto livre)
- 2: 1200 Nm - Autostop: a chave de impacto aplica o binário máximo até a porca estar totalmente desapertada e para automaticamente (desaperto por impacto único)



1984 20V/1200BMC

€ 409,00 1 019840911

490x370x125 mm - 4,7 kg



## 1986/K20V-125

kit rebarbadora, 20V, BRUSHLESS

Motor BRUSHLESS

Desempenho significativamente melhorado: maior potência, redução do consumo de energia, vida útil prolongada do motor, fornecimento de energia melhorado do botão

Características principais

- Proteção contra arranque involuntário
- Punho adicional que pode ser montado em ambos os lados
- Resguardo do disco sem ferramentas (libertação rápida)
- Dispositivo de bloqueio do veio para substituição rápida do disco
- Interruptor deslizante on/off
- Entradas de ar protegidas contra infiltração de poeiras, proporcionam um arrefecimento eficaz
- Fornecido em mala rígida, Fornecido em mala rígida com 2 baterias de íões de lítio (4 Ah) e carregador rápido

Características técnicas

- Diâmetro do disco (não incluído): 125/115 mm
- Rotações em vazio: 8.000 rpm
- Rosca do veio: M14
- Comprimento do cabo: 4 m

Beta  
**3-YEAR  
WARRANTY**



CE

1986/K20V-125

490x370x125 mm - 5,6 kg

€ 625,00



1



019860015

## 1986/20V-125BMC

rebarbadora, 20V BRUSHLESS, (sem baterias e sem carregador)

Motor BRUSHLESS

Desempenho significativamente melhorado: maior potência, redução do consumo de energia, vida útil prolongada do motor, fornecimento de energia melhorado do botão

Características principais

- Proteção contra arranque involuntário
- Punho adicional que pode ser montado em ambos os lados
- Resguardo do disco sem ferramentas (libertação rápida)
- Dispositivo de bloqueio do veio para substituição rápida do disco
- Interruptor deslizante on/off
- Entradas de ar protegidas contra infiltração de poeiras, proporcionam um arrefecimento eficaz
- Fornecido em mala rígida, sem baterias e sem carregador

Características técnicas

- Diâmetro do disco (não incluído): 125/115 mm
- Rotações em vazio: 8.000 rpm
- Rosca do veio: M14
- Comprimento do cabo: 4 m

Beta  
**3-YEAR  
WARRANTY**



CE

1986/20V-125BMC

490x370x125 mm - 3,8 kg

€ 257,00



1



019860025



**Beta**

## 1994B 20V-2AH

bateria de íões de lítio 2Ah, 20V

Tecnologia premium de íões de lítio

Com botão e 3 indicadores LED coloridos de nível de carga

Características principais

- Voltagem da bateria: 20V
- Capacidade da bateria: 2Ah
- Capacidade energética: 40Wh
- Tipo de bateria: Li-ion

410 g

1994B 20V-2AH

€ 72,00 1 019940022



CE

## 1994B 20V-4AH

bateria de íões de lítio 4Ah, 20V

Tecnologia premium de íões de lítio

Com botão e 3 indicadores LED coloridos de nível de carga

Características principais

- Voltagem da bateria: 20V
- Capacidade da bateria: 4Ah
- Capacidade energética: 80Wh
- Tipo de bateria: Li-ion

660 g

1994B 20V-4AH

€ 120,00 1 019940044



CE

## 1994B 20V-6AH

bateria de íões de lítio 6Ah, 20V

Tecnologia premium de íões de lítio

Com botão e 3 indicadores LED coloridos de nível de carga

Características principais

- Voltagem da bateria: 20V
- Capacidade da bateria: 6Ah
- Capacidade energética: 120Wh
- Tipo de bateria: Li-ion

900 g

1994B 20V-6AH

€ 166,00 1 019940066



CE

## 1994C 20V

carregador rápido, 20V, 110V-240V

Características principais:

- Indicador LED de nível de carga
- Voltagem nominal de entrada: 110V-240V ~ 50/60Hz
- Voltagem de saída: 20V
- Corrente de carga: 6A
- Potência nominal de entrada: 145W

Tempo de carregamento da bateria 20V 2Ah: 45 min

Tempo de carregamento da bateria 20V 4Ah: 90 min

Tempo de carregamento da bateria 20V 6Ah: 120 min

680 g

1994C 20V

€ 127,00 1 019940140



CE

## 1989RCB

rádio para estaleiro, 20V

CE

Entretenimento multifunções: rádio FM digital (DAB; BT) e convencional  
Adequado para uso em estaleiros de construção ou para lazer

Rádio robusto com design compacto, moderno, grau de proteção IP54  
Som estéreo potente fornecido por duas potentes colunas laterais de 16 W

Função de alarme integrada

Completo com punho de transporte e proteção dos cantos anti-impacto  
Com ligação AUX e entrada USB protegido para ligação e carregamento do telefone

Pode ser utilizado com baterias de 20V da Beta (opcionais) ou cabo de alimentação (incluído).

Características principais:

- Intervalo de frequência de rádio FM: 87.5 – 108 MHz
- Intervalo de frequência de rádio DAB: 174 – 240 MHz
- Número de estações FM e DAB armazenadas: 30
- Potência das colunas: 16 W
- Potência nominal da bateria (opcional): 20 V
- Dimensões: 180 x 205 x 305 mm
- Peso (sem bateria): 3.2 kg



1989RCB

€ 371,00 1 019890020

## C9PT

saco para ferramentas elétricas em tecido técnico

Perfeito para transportar convenientemente as ferramentas elétricas Beta

Em tecido técnico de elevada durabilidade

Pega superior dupla para manuseamento seguro e equilibrado

C9PT

410x210x280 mm - 700 g

€ 46,00 1 021090001



# Beta





## FERRAMENTAS COM FIO



A gama de ferramentas com fio inclui **rebarbadoras, berbequins de percussão, aparafusadoras de impacto, aspiradores de sólidos e líquidos, pistolas de ar quente e de cola.**

Em particular, as rebarbadoras Beta (com potências de 750W a 2400W) estão a revelar-se cada vez mais bem-sucedidas com base nas seguintes características de construção:

- **Desempenho excepcional**
  - Motor potente, com resina, resistente ao desgaste e durável
  - Saídas de ar que proporcionam a refrigeração ideal, protegidas contra infiltração de poeiras
- **Segurança inigualável para operadores**
  - Dispositivo de bloqueio do veio para substituição rápida do disco
  - Proteção contra arranque involuntário
  - Arranque suave para limitar picos de corrente no arranque
- **Conforto e facilidade de manuseamento exclusivos**
  - Punho ergonómico antiderrapante para maior conforto e segurança
  - Cabeça rebaixada que permite trabalhar em espaços reduzidos

Cabo anti-enrolamento não inferior a 4 metros de comprimento para maior facilidade de movimentos  
Punho adicional que pode ser montado em ambos os lados.

### 1956 115-750W

rebarbadora para discos Ø 115 mm

Ideal para trabalhos de corte, rebarbagem e desbaste

Motor potente (750 W)

Punho ergonómico antiderrapante para maior conforto e segurança

Cabeça rebaixada que permite trabalhar em espaços confinados

Extremamente leve (pesa no máximo 1,8 kg)

Principais características

- Proteção contra arranque involuntário
- Punho adicional que pode ser montado em ambos os lados
- Resguardo do disco sem ferramentas (libertação rápida)
- Dispositivo de bloqueio do veio para substituição rápida do disco
- Interruptor deslizante on/off
- Entradas de ar protegidas contra infiltração de poeiras, proporcionam um arrefecimento eficaz
- Chave de serviço incluída

1,8 kg



1956 115-750W

€ 89,00 1 019560011

## 1956 125-1400W

rebarbadora para discos Ø 125 mm

Ideal para trabalhos de corte, rebarbagem e desbaste

Motor potente (1400 W) - Velocidade variável  
Punho ergonómico antiderrapante para maior conforto e segurança  
Cabeça rebaixada que permite trabalhar em espaços confinados

Principais características

- Proteção contra arranque involuntário
- Punho adicional antivibrações que pode ser montado em ambos os lados
- Resguardo do disco sem ferramentas (libertação rápida)
- Dispositivo de bloqueio do veio para substituição rápida do disco
- Interruptor deslizante on/off
- Entradas de ar protegidas contra infiltração de poeiras, proporcionam um arrefecimento eficaz
- Chave de serviço incluída

2,5 kg

CE

L = 4 m



Ø 125 mm

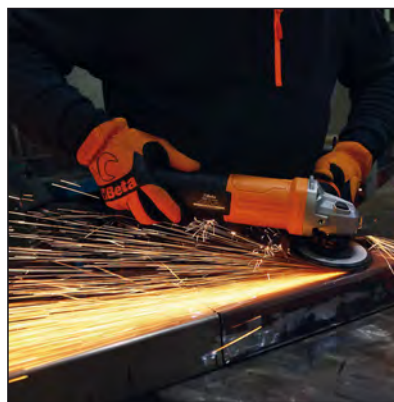

1956 125-1400W

€ 173,00 1 019560125

## 1956 230-2400W

rebarbadora para discos Ø 230 mm

Ideal para trabalhos de corte, rebarbagem e desbaste

Motor potente (2400 W) - Velocidade variável  
Punho ergonómico antiderrapante para maior conforto e segurança

Principais características

- Proteção contra arranque involuntário
- Arranque suave com limitação da corrente
- Punho adicional antivibrações que pode ser montado em ambos os lados
- Resguardo do disco com parafuso
- Dispositivo de bloqueio do veio para substituição rápida do disco
- Interruptor deslizante on/off
- Entradas de ar protegidas contra infiltração de poeiras, proporcionam um arrefecimento eficaz
- Chave de serviço incluída

5,8 kg

CE

L = 4 m



Ø 230 mm



1956 230-2400W

€ 233,00 1 019560230

## 1966/910W

berbequim de percussão, 910W

Ideal para furar diversos materiais, incluindo madeira, metal, plástico, alvenaria e betão

Motor potente 910W

Design linear e compacto com punho ergonómico e antiderrapante

Bucha automática de 13 mm

Velocidade variável reversível

Caixa de engrenagens inteiramente em metal

Bloqueio do interruptor para maior conforto de utilização

Principais características:

- Diâmetro máx. de perfuração em madeira: 32 mm
- Diâmetro máx. de perfuração em metal: 13 mm
- Diâmetro máx. de perfuração em alvenaria: 13 mm
- Rotações em vazio: 0-2.800 rpm
- Comprimento do cabo: 4 m

Acessórios fornecidos:

- Bucha automática de 13 mm
- Punho lateral adicional com rotação 360°
- Limitador de profundidade



1966/910W

420x320x120 mm - 4,3 kg

€ 164,00

1

019660091

## 1967/800W

martelo combinado SDS-PLUS, 800W

Ideal para furar, furar com percussão e demolir em alvenaria, betão, azulejos, madeira e metal

Motor potente 800W para aplicações pesadas

Profissional, leve e potente

Design ergonómico, compacto para trabalhar em espaços reduzidos/de difícil acesso

Características principais

3 modos de funcionamento + função Vario-Lock:

- função furar
- função furar com percussão
- função demolir
- função vario-lock: pode ser bloqueado em 36 posições, para obter um ângulo de trabalho ideal

• Diâmetro máx. de perfuração em madeira: 30 mm

• Diâmetro máx. de perfuração em metal: 13 mm

• Diâmetro máx. de perfuração em betão: 26 mm

Reversível

Embraiagem de segurança

Energia máx. por golpe: 3.2 J

Rotações em vazio: 0-1350 rpm

Número máx. de impactos: 0-5700 impactos/min

Comprimento do cabo: 4 m

Acessórios fornecidos:

- Bucha 13 mm com adaptador SDS-PLUS
- Punho lateral adicional com rotação 360°
- Limitador de profundidade
- 3 brocas de percussão, Ø 8-10-12 mm, comp. 150 mm
- 1 escopro plano, 14x250 mm
- 1 ponteiro, 14x250 mm



1967/800W

420x300x115 mm - 5,2 kg

€ 218,00

1

019670080





### 1850D

pistola térmica de 3 velocidades

- Pos. I 250 l/min 50 °C
- Pos. II 250 l/min 400 °C
- Pos. III 500 l/min 550 °C



1850D	L mm 255	H mm 210	€ 151,00	1	018500018
-------	----------------	----------------	-------------	---	-----------

### 1850E

pistola térmica eletrônica ajustável

- Pos. I 250-500 l/min 50 °C
- Pos. II 250-500 l/min 50-650 °C

- monitor digital
- botões de regulação da temperatura e fluxo
- 4 programas pré-definidos e outros personalizáveis

- Prog 1 150 °C ca. 400 l/min
- Prog 2 200 °C ca. 400 l/min
- Prog 3 300 °C ca. 450 l/min
- Prog 4 400 °C ca. 500 l/min



1850E	L mm 255	H mm 210	€ 316,00	1	018500020
-------	----------------	----------------	-------------	---	-----------

### 1851VK

pistola de colagem a quente com 12 tubos de cola em caixa

- potência: 80 W
- para tubos de cola, Ø 11 mm e 12 mm

CE



1851VK	€ 62,50	1	018510058
--------	------------	---	-----------

320x250x50 mm

### 1851VK-12C

12 bastões de cola  
Ø 11 mm



1851VK-12C	€ 16,00	1	018510062
------------	------------	---	-----------

### 1851VK-12V

12 bastões de cola  
para superfícies pintadas  
Ø 11 mm



1851VK-12V	€ 16,00	1	018510072
------------	------------	---	-----------



### 1870

aspirador para sólidos e líquidos, 20 l

- motor bypass monofásico
- voltagem: 220/240 V
- frequência: 50/60 Hz
- potência máx.: 1200 W
- débito : 58 l/sec.
- potência máx. de aspiração: 190 mbar
- cap. máx. do tambor: 20 l, em PP antiestático
- emissão sonora: <70 dB(A)
- comp. do cabo: 5 m
- carro para acessórios
- ACESSÓRIOS STANDARD, Ø 36 mm
- 1 tubo flexível com punho ergonômico
- 2 tubos de extensão rígidos
- 1 escova multiusos para soalhos e líquidos
- 1 bocal plano
- SISTEMAS DE FILTRAGEM
- 1 filtro de cartucho de superfície 1900 cm<sup>2</sup> - 12 µm nom.
- 1 filtro anti-espuma PPI 45/PPI 30

CE



IPX4

1870	€ 269,00	1	018700020
------	-------------	---	-----------

### 1870I

aspirador para sólidos e líquidos, 20 l,  
tambor em aço inox

- motor bypass de um estágio
- voltagem: 220/240 V
- frequência: 50/60 Hz
- potência máx.: 1200 W
- débito: 58 l/seg..
- potência máx. de aspiração: 190 mbar
- capacidade máx. do tambor: 20 l, em aço inox
- emissão sonora: <70 dB(A)
- comprimento do cabo: 5 m
- ACESSÓRIOS STANDARD Ø 36 mm
- 1 tubo flexível com punho ergonômico
- 2 tubos de extensão rígidos
- 1 escova multiusos para chão e líquidos
- 1 bocal plano
- 1 saco de papel
- SISTEMAS DE FILTRAGEM
- 1 filtro de cartucho de superfície 1900 cm<sup>2</sup> - 12 µm nom.
- 1 filtro anti-espuma PPI 45/PPI 30

CE



IPX4

1870I	€ 299,00	1	018700020
-------	-------------	---	-----------

## 1872L

aspirador para sólidos e líquidos, 35 l, classe certificada "L"

- by-pass do motor de dois estágios
- voltagem: 220/240 V
- frequência: 50/60 Hz
- potência máx.: 1.100 W
- débito: 55 l/sec.
- potência máx. de aspiração: 220 mbar
- capacidade máx. do tambor: 35 l, antiestático PE-HD
- emissão sonora: <70 dB(A)
- comprimento do cabo: 6 m

ACESSÓRIOS STANDARD, Ø 36 mm

- 1 tubo flexível com um punho ergonómico
- 2 tubos de extensão em plástico
- 1 escova combinada
- 1 secção com tubos de aspiração de líquidos
- 1 bocal plano

SISTEMAS DE FILTRAGEM

- 1 saco de filtro em papel; filtragem classe "L"
- 1 filtro de cartucho de superfície; IFA classe: "L"
- 1 filtro anti-espuma PPI 45/PPI 30
- 2 pós-filtros em PET lâmina PP

CE



IPX4

1872L 35 € 590,00 1 018720135

## 1873

aspirador para sólidos e líquidos, 30 l, tambor em aço inoxidável

Função soprador

Rodas anti-marcas

- motor bypass de dois estágios
- voltagem: 220/240 V • frequência 50/60 Hz
- potência máx.: 1100 W • débito : 55 l/sec.
- pressão máx. aspiração: 220 mbar
- cap. máx. tambor: 30 l, em aço inoxidável
- emissão sonora: <61 dB(A) • comp. cabo: 6 m
- carro para acessórios

ACESSÓRIOS STANDAR, Ø 45 mm

- 1 tubo flexível com punho ergonómico
- 2 tubos de extensão em aço inoxidável
- 1 escova industrial
- 1 adaptador industrial para alcatifas
- 1 secção industrial tubos para aspiração de líquidos
- 1 bocal plano • 1 bocal triangular

SISTEMAS DE FILTRAGEM

- 1 saco de filtro em papel
- 1 filtro de cartucho de superfície 1900 cm<sup>2</sup>, 12 µm nom.
- 1 filtro anti-espuma PPI 45/PPI 30

CE



1873 30 € 785,00 1 018730030

## 1874

aspirador para sólidos e líquidos, 50 l, tambor em aço inoxidável

Função soprador

Rodas anti-marcas

- motor bypass de dois estágios
- voltagem: 220/240 V • frequência: 50/60 Hz
- potência máx.: 1350 W • débito : 55 l/sec.
- pressão máx. aspiração: 240 mbar
- cap. máx. do tambor: 50 l, em aço inoxidável
- emissão sonora: <63 dB(A) • comp. cabo: 6 m
- carro para acessórios

ACESSÓRIOS STANDARD: Ø 45 mm

- 1 tubo flexível com punho ergonómico
- 2 tubos de extensão em aço inoxidável
- 1 escova industrial
- 1 adaptador industrial para alcatifas
- 1 secção industrial com tubos de aspiração de líquidos
- 1 bocal plano

SISTEMAS DE FILTRAGEM

- 1 saco de filtro em papel
- 1 filtro de cartucho de superfície 5200 cm<sup>2</sup>, 12 µm nom.
- 1 filtro anti-espuma PPI 45/PPI 30

CE



1874 50 € 990,00 1 018740050

## 1870-20/5S

5 sacos de papel horizontais para artigo 1870- 1870I-1875LT



1870 20/5S € 61,50 1 018700021

## 1870-72 /FC

filtro de cartucho 1900 cm<sup>2</sup> 12 - µm nom.  
Para artigos 1870 - 1870I - 1873 - 1875LT



1870/FC € 52,50 1 018700026

## 1870-72/FL

filtro para aspiração de líquidos para artigos 1870 - 1870I - 1872L - 1873 - 1874 - 1875LT



1870 72/FL € 19,30 1 018700027

## 1872L 35/FC

filtro de cartucho, classe "L", para artigo 1872L



1872L 35/FC € 63,50 1 018720144

## 1872L 35/5S

5 sacos de pano descartáveis, classe "L" para artigo 1872L- 1873



1872L 35/5S € 96,50 1 018720136

## 1873-30/5S

5 sacos de papel verticais para artigo 1873



1873 30/5S € 61,50 1 018730031

## 1874-50/5S

5 sacos verticais para artigo 1874



1874 50/5S € 77,50 1 018740051

## 1874-50/FC

filtro de cartucho 5200 cm<sup>2</sup> - 12 µm nom. para artigo 1874



1874 50/FC € 63,00 1 018740056





# FERRAMENTAS PNEUMÁTICAS E ACESSÓRIOS



Nos últimos 20 anos, a Beta Utensili tem vindo a complementar a sua linha de produtos com uma selecção abrangente de ferramentas pneumáticas e acessórios desenvolvidos para os mercados de manutenção automóvel e industrial: chaves de impacto, roquetes, berbequins, rectificadoras, lixadeiras e muitos outros produtos.

Durante este período, a cooperação estreita com os utilizadores profissionais tem sido a chave para o crescimento contínuo. É com base nesse crescimento que as ferramentas pneumáticas Beta apresentam uma excelente relação fiabilidade/desempenho.

Para satisfazer as exigências do mercado, a Beta Utensili efectua a reparação das ferramentas pneumáticas no seu Departamento de Qualidade. Este processo permitiu melhorar o seu know-how de forma significativa e tornar-se cada vez mais sensível à carteira de clientes.

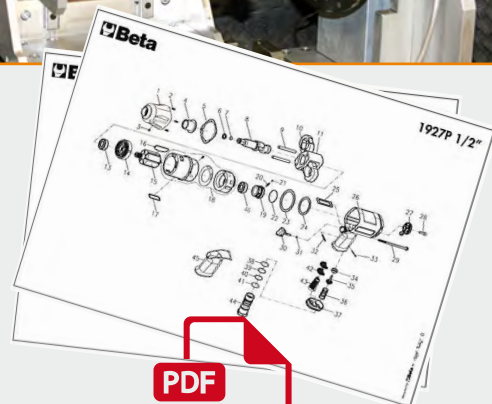
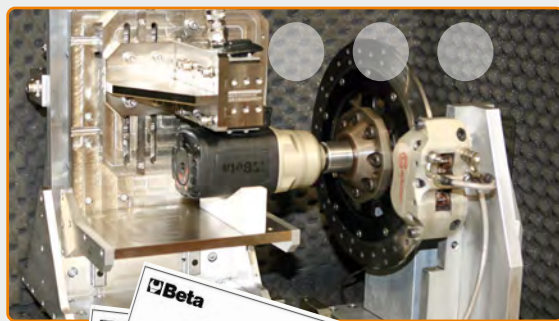

[www.beta-tools.com](http://www.beta-tools.com)



## CHAVES DE IMPACTO

■	BETA ITEM	N °.	MATERIAL	 max. Nm	 db (A) LpA	 db (A) LpW	 I/min.	 kg	MECANISMO	 m/s <sup>2</sup>
<b>3/8"</b>		<b>1924F</b>	Alumínio	<b>108</b>	93,6	104,6	59	0,5	Mecanismo de impacto duplo	6,85
<b>3/8"</b>		<b>1924XM</b>	Material compósito	<b>515</b>	91,7	102,7	122	1,3	Mecanismo de impacto simples	6,2
<b>1/2"</b>		<b>1927AN</b>	Alumínio	<b>244</b>	89,4	100,4	190	2,1	Mecanismo de impacto simples	8,63
<b>1/2"</b>		<b>1927G</b>	Alumínio	<b>325</b>	92,2	103,2	113	1,2	Mecanismo de impacto simples	9,96
<b>1/2"</b>		<b>1927E</b>	Material compósito	<b>750</b>	87,0	98,0	140	2,4	Mecanismo de impacto duplo	2,2
<b>1/2"</b>		<b>1927XM</b>	Alumínio	<b>770</b>	102	113	122	1,3	Mecanismo de impacto simples	7,5
<b>1/2"</b>		<b>1927C</b>	Material compósito	<b>950</b>	88,2	99,2	125	2,1	Mecanismo de impacto duplo	9,6
<b>1/2"</b>		<b>1927P</b>	Material compósito	<b>1.750</b>	95,1	106,1	290	2,0	Mecanismo de impacto duplo	6,7
<b>1/2"</b>		<b>1927OLS</b>	Alumínio	<b>1.750</b>	93,2	104,2	198	2,5	Mecanismo de impacto duplo	8,1
<b>3/4"</b>		<b>1928XM</b>	Alumínio	<b>1.600</b>	91,8	102,8	175	2,9	Mecanismo de impacto duplo	12,96
<b>3/4"</b>		<b>1928DA</b>	Alumínio	<b>1.695</b>	96	99,5	300	4,3	Mecanismo de impacto duplo	3,6
<b>3/4"</b>		<b>1928DAL</b>	Alumínio	<b>1.695</b>	96	99,5	300	4,8	Mecanismo de impacto duplo	3,6
<b>3/4"</b>		<b>1928P</b>	Material compósito	<b>2.100</b>	96,2	107,2	221	3,7	Mecanismo de impacto duplo	7,6
<b>1"</b>		<b>1930PA</b>	Alumínio	<b>2.445</b>	96,0	97,1	410	9,6	Mecanismo de impacto duplo	7,2
<b>1"</b>		<b>1930A</b>	Alumínio	<b>2.445</b>	103,3	114,3	460	9,5	Mecanismo de impacto duplo	67
<b>1"</b>		<b>1930LH</b>	Alumínio	<b>2.441</b>	97,1	108,1	282	7,1	Mecanismo de impacto duplo	17,4
<b>1"</b>		<b>1930LA</b>	Alumínio	<b>2.445</b>	95,6	97,1	460	10,6	Mecanismo de impacto duplo	3,6
<b>1"</b>		<b>1930HLA</b>	Alumínio	<b>3.661</b>	99	101	460	16,4	Mecanismo de impacto duplo	16,4
<b>1 1/2"</b>		<b>1930ZL</b>	Alumínio	<b>4.068</b>	102,4	113,4	480	15	Mecanismo de impacto duplo	69,6



## ROQUETES PNEUMÁTICOS

■	BETA ITEM	N°	max. Nm	db (A) LpA	db (A) LpW	l/min.	kg	m/s <sup>2</sup>
<b>1/4"</b>		<b>1921B1</b>	<b>24</b>	96	85	90	0,4	2.6
<b>1/4"</b>		<b>1921M1</b>	<b>27</b>	84	88	96	0,6	1.8
<b>1/4"</b>		<b>1922P1</b>	<b>68</b>	90,6	101,6	88	0,6	8.61
<b>3/8"</b>		<b>1921M2</b>	<b>27</b>	84	88	96	0,6	1.8
<b>3/8"</b>		<b>1922P2</b>	<b>68</b>	90,6	101,6	88	0,6	8.61
<b>1/2"</b>		<b>1921N3</b>	<b>68</b>	80	87	140	1,2	2.6
<b>1/2"</b>		<b>1922P3</b>	<b>136</b>	94,9	105,9	113	1,5	18.28

## RECTIFICADORAS

	BETA ITEM	N°	POTÊNCIA	db (A) LpA	db (A) LpW	l/min.	kg	m/s <sup>2</sup>
		<b>1933</b>	<b>0,20 kW</b>	80,0	87,0	230	0,38	4,53
		<b>1933L</b>	<b>0,20 kW</b>	80,0	87,0	270	0,67	1,15
		<b>1933AN90</b>	<b>0,20 kW</b>	80,0	87,0	230	0,51	1,24
		<b>1933I</b>	<b>0,38 kW</b>	80,0	87,0	260	0,67	4,53
		<b>1933IL</b>	<b>0,38 kW</b>	79,0	97,0	113	1,4	1,6
		<b>1933IH</b>	<b>0,75 kW</b>	88,1	99,1	370	0,8	2,6
		<b>1933ILH</b>	<b>0,75 kW</b>	85,7	96,7	370	1,2	1,4
		<b>1933AN90-H</b>	<b>0,75 kW</b>	85,6	96,6	370	1,1	6,7
		<b>1934MAV</b>	<b>0,04 kW</b>	71	76	115	0,2	2,5
		<b>1934MAV70</b>	<b>0,08 kW</b>	80	87	115	0,2	4

## 1921B1

mini roquete pneumático reversível

14"

CE



130 mm

Rotação em vazio	350 rpm
Torque max.	24 Nm
Capacidade parafuso	Cl 8.8 M7●11 mm
Capacidade parafuso	Cl 12.9 M6●10 mm
Entrada de ar	1/4" GAS
Pressão de trabalho	6.2 bar
Ø interno do tubo	8 mm
Consumo médio de ar	68 l/min
Peso	0,4 kg

1/4	€ 226,00	1	019210001
-----	----------	---	-----------

## 1921N3

roquete pneumático reversível

12"

CE



258 mm

Rotação em vazio	150 rpm
Torque max.	68 Nm
Capacidade parafuso	Cl 8.8 M10●16 mm
Capacidade parafuso	Cl 12.9 M8●13 mm
Entrada de ar	1/4" GAS
Pressão de trabalho	6.2 bar
Ø interno do tubo	10 mm
Consumo médio de ar	140 l/min
Peso	1.2 kg

1/2	kg 1,2	€ 200,00	1	019210025
-----	--------	----------	---	-----------

## 1922P3

roquete reversível com superfície de percussão

• Dispositivo de impulso especial "Double rocking dog"

12"

CE



292 mm

Velocidade	600 rpm
Binário máximo	136 Nm
Capacidade do parafuso	Cl 8.8 M12●18 mm
Capacidade do parafuso	Cl 12.9 M10●16 mm
Entrada de ar	1/4" GAS
Pressão de trabalho	6.2 bar
Ø interno do tubo	10 mm
Consumo médio de ar	113 l/min
Peso	1.5 kg

1/2	kg 1,5	€ 382,00	1	019220013
-----	--------	----------	---	-----------

## 1921M1

roquete pneumático reversível

• Manipulo regulador de velocidade

14"

CE



198 mm

Rotação em vazio	200 rpm
Torque max.	27 Nm
Capacidade parafuso	Cl 8.8 M7●11 mm
Capacidade parafuso	Cl 12.9 M6●10 mm
Entrada de ar	1/4" GAS
Pressão de trabalho	6.2 bar
Ø interno do tubo	8 mm
Consumo médio de ar	96 l/min
Peso	0.6 kg

1/4	kg 0,6	€ 200,00	1	019210005
-----	--------	----------	---	-----------

## 1922P1

roquete reversível com superfície de percussão

• Dispositivo de impulso especial "Double rocking dog"

14"

CE



164 mm

Velocidade	700 rpm
Binário máximo	68 Nm
Capacidade do parafuso	Cl 8.8 M10●16 mm
Capacidade do parafuso	Cl 12.9 M8●13 mm
Entrada de ar	1/4" GAS
Pressão de trabalho	6.2 bar
Ø interno do tubo	10 mm
Consumo médio de ar	88 l/min
Peso	0.6 kg

1/4	kg 0,6	€ 242,00	1	019220006
-----	--------	----------	---	-----------

## 1924F

chave de impacto reversível tipo borboleta

• Dispositivo de impulso especial "Double rocking dog"

3/8"

CE



139 mm

Velocidade	12,000 rpm
Binário máximo	108 Nm
Capacidade do parafuso	Cl 8.8 M12●18 mm
Capacidade do parafuso	Cl 12.9 M10●16 mm
Entrada de ar	1/4" GAS
Pressão de trabalho	6.2 bar
Ø interno do tubo	10 mm
Consumo médio de ar	59 l/min
Peso	0.5 kg

3/8	kg 0,5	€ 224,00	1	019240025
-----	--------	----------	---	-----------

## 1921M2

roquete pneumático compacto reversível

• Manipulo regulador de velocidade

3/8"

CE



198 mm

Rotação em vazio	200 rpm
Torque max.	27 Nm
Capacidade parafuso	Cl 8.8 M7●11 mm
Capacidade parafuso	Cl 12.9 M6●10 mm
Entrada de ar	1/4" GAS
Pressão de trabalho	6.2 bar
Ø interno do tubo	8 mm
Consumo médio de ar	96 l/min
Peso	0.6 kg

3/8	kg 0,6	€ 200,00	1	019210015
-----	--------	----------	---	-----------

## 1922P2

roquete reversível com superfície de percussão

• Dispositivo de impulso especial "Double rocking dog"

3/8"

CE



164 mm

Velocidade	700 rpm
Binário máximo	68 Nm
Capacidade do parafuso	Cl 8.8 M10●16 mm
Capacidade do parafuso	Cl 12.9 M8●13 mm
Entrada de ar	1/4" GAS
Pressão de trabalho	6.2 bar
Ø interno do tubo	10 mm
Consumo médio de ar	88 l/min
Peso	0.6 kg

3/8	kg 0,6	€ 242,00	1	019220010
-----	--------	----------	---	-----------





## 19270LS - CHAVE DE IMPACTO SEM ÓLEO

### A REVOLUCIONÁRIA CHAVE DE IMPACTO QUE NÃO REQUER LUBRIFICAÇÃO



A chave de impacto 19270LS, totalmente concebida, desenvolvida e desenhada pela Beta Utensili, conta com o sistema **OIL-LESS**, uma inovação na indústria das ferramentas pneumáticas: permite que a chave de impacto funcione sem necessidade de lubrificação periódica com óleo, garantindo assim uma maior durabilidade e alto desempenho.



A chave de impacto OIL-LESS destaca-se pela **transmissão de binário elevado** - ou seja, **1750 Nm** - o que a torna ideal para qualquer aplicação.

A montagem meticulosa, o alinhamento micrométrico das peças internas e a utilização de materiais inovadores de primeira linha resultam num número reduzido de avarias, para uma utilização vitalícia **sem lubrificação**.

Com base nestas características, a chave de impacto OIL-LESS pode apresentar uma excelente relação custo/benefício, traduzindo-se assim numa poupança a longo prazo.

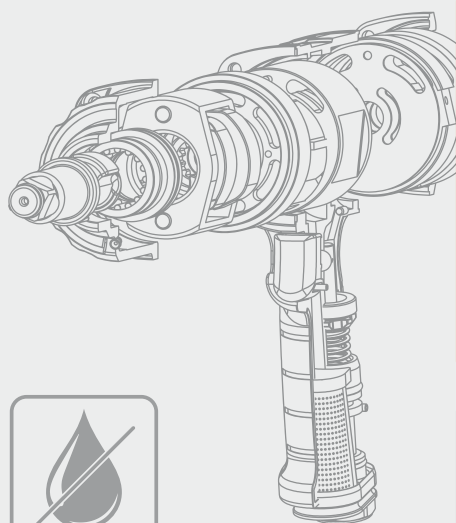

**4X** 4 VEZES A VIDA ÚTIL DE UMA CHAVE DE IMPACTO CLÁSSICA



## 1924XM

chave de impacto reversível compacta

• Dispositivo de impacto único

3/8"  
CE



Velocidade livre	9,000 rpm/min
Torque máx.	515 Nm
Capac. Parafuso	Cl 8.8 M16 ● 24 mm
Capac. Parafuso	Cl 12.9 M14 ● 21 mm
Admissão de ar	1/4" GAS
Pressão de trabalho	6.2 bar
Dimensão interna do tubo (Ø)	10 mm
Consumo de ar médio	122 l/min
Peso	1.3 kg

3/8"	kg 1,3	€ 248,00	1	019240030
------	-----------	-------------	---	-----------

## 19270LS

chave de impacto reversível OIL-LESS, corpo em liga de alumínio

• Não necessita de lubrificação  
• Mecanismo de impacto duplo

1/2"  
CE



Rotação em vazio	8,000 rpm
Torque máx.	1,750 Nm
Capacidade parafuso	Cl 8.8 M24 ● 36 mm
Capacidade parafuso	Cl 12.9 M20 ● 30 mm
Entrada de ar	1/4" GAS
Pressão de trabalho	6.2 bar
(Ø) interno do tubo	10 mm
Consumo médio de ar	198 l/min
Peso	2.5 kg

1/2"	kg 2,5	€ 640,00	1	019270010
------	-----------	-------------	---	-----------

## 1927E

chave de impacto reversível, em material compósito

• Mecanismo de impacto duplo



Rotação em vazio	7,000 rpm
Torque máx.	750 Nm
Capacidade parafuso	CI 8.8 M24●36 mm
Capacidade parafuso	CI 12.9 M20●30 mm
Entrada de ar	1/4" GAS
Pressão de trabalho	6.2 bar
(Ø) interno do tubo	10 mm
Consumo médio de ar	197 l/min
Peso	2.4 kg

1/2"	kg	€	1	019270005
2,4	123,00			

## 1927P

chave de impacto reversível em material compósito

• Mecanismo de impacto duplo



Velocidade	7,500 rpm
Binário máx.	1.750 Nm
Capacidade do parafuso	CI 8.8 M24●36 mm
Capacidade do parafuso	CI 12.9 M20●30 mm
Entrada de ar	1/4" GAS
Pressão de trabalho	6.2 bar
Diâm. interno do tubo	10 mm
Consumo médio de ar	290 l/min
Peso	2 kg

1/2"	kg	€	1	019270008
2,0	393,00			

## 1927XM

chave de impacto compacta reversível

• Dispositivo de impacto simples



Velocidade livre	10,000 rpm
Torque máx.	770 Nm
Capacidade parafuso	CI 8.8 M22●34 mm
Capacidade parafuso	CI 12.9 M18●27 mm
Entrada de ar	1/4" GAS
Pressão de trabalho	6.2 bar
Dimens. tubo interno (Ø)	10 mm
Consumo de ar médio	122 l/min
Peso	1.3 kg

1/2"	kg	€	1	019270030
1,3	245,00			

## 1927C

chave de impacto reversível, em material compósito

• Mecanismo de impacto duplo



Rotação em vazio	9,000 rpm
Torque máx.	900 Nm
Capacidade parafuso	CI 8.8 M22●34 mm
Capacidade parafuso	CI 12.9 M18●27 mm
Entrada de ar	1/4" GAS
Pressão de trabalho	6.2 bar
(Ø) interno do tubo	10 mm
Consumo médio de ar	125 l/min
Peso	2.1 kg

1/2"	kg	€	1	019270006
2,1	205,00			

## 1927P/K3

chave de impacto reversível, em material compósito, fornecida com 3 chaves de caixa de impacto



Velocidade em vazio	7,500 rpm
Binário máx.	1.750 Nm
Capacidade do parafuso	CI 8.8 M24●36 mm
Capacidade do parafuso	CI 12.9 M20●30 mm
Entrada de ar	1/4" GAS
Pressão de trabalho	6.2 bar
Ø interno do tubo	10 mm
Consumo médio de ar	290 l/min
Peso	2.9 kg

1/2"	kg	€	1	019270118
4	515,00			
350x305x86 mm				

## 1927XM/K5

Jogo de uma chave de impacto compacta reversível e cinco chaves de impacto

• Mecanismo de impacto simples



Velocidade em vazio	10,000 rpm
Torque máx.	770 Nm
Capacidade do parafuso	CI 8.8 M22●34 mm
Capacidade do parafuso	CI 12.9 M18●27 mm
Entrada de ar	1/4" GAS
Pressão de trabalho	6.2 bar
Diâmetro interno do tubo	10 mm
Consumo médio de ar	122 l/min
Peso	1.3 kg

1/2"	kg	€	1	019270129
2,8	301,00			
307x206x86 mm				

## 1927AN

Chave de impacto angular reversível

- Dispositivo de impacto simples

12"

CE



Rotações em vazio	4,700 rpm
Binário máx.	244 Nm
Capacidade parafuso	Cl 8.8 M14 ● 21 mm
Capacidade parafuso	Cl 12.9 M12 ● 19 mm
Entrada de ar	1/4" GAS
Pressão de trabalho	6,2 bar
Ø interno do tubo	10 mm
Consumo médio de ar	190 l/min
Peso	2.1 kg

1/2"	kg	€	1	019270012
	2,1	465,00		

## 1927G

chave de impacto reversível compacta

- Dispositivo de impulso simples

12"

CE



Rotação em vazio	8500 rpm
Torque máx.	325 Nm
Capacidade parafuso	Cl 8.8 M16 ● 24 mm
Capacidade parafuso	Cl 12.9 M14 ● 21 mm
Entrada de ar	1/4" GAS
Pressão de trabalho	6.2 bar
Ø interno do tubo	10 mm
Consumo médio de ar	113 l/min
Peso	1.2 kg

1/2"	kg	€	1	019270050
	1,2	382,00		

## 1927SP-AM

suporte magnético para chave de impacto

- Possui dois ímãs de elevado magnetismo com protecção de borracha nas extremidades
- Pode alojar 1 chave de impacto 1/2", 4 chaves de caixa e 1 chave dinamométrica
- Capacidade: 10 kg



400 g	€	1	019270000
	57,00		

## 1928DA

chave de impacto pneumática reversível

- Dispositivo de impacto duplo

3/4"

CE



Rotação em vazio	5,000 rpm
Torque máx.	1.695 Nm
Capacidade parafuso	Cl 8.8 M30 ● 46 mm
Capacidade parafuso	Cl 12.9 M27 ● 41 mm
Entrada de ar	3/8" GAS
Pressão de trabalho	6,2 bar
(Ø) interno do tubo	10 mm
Consumo médio de ar	240 l/min
Peso	4,3 kg

3/4"	kg	€	1	019280022
	4,3	755,00		

## 1928DAL

Chave de impacto pneumática reversível

- Dispositivo de impacto duplo

3/4"

CE



Rotação em vazio	5,000 rpm
Torque máx.	1.695 Nm
Capacidade parafuso	Cl 8.8 M27 ● 41 mm
Capacidade parafuso	Cl 12.9 M24 ● 36 mm
Entrada de ar	3/8" GAS
Pressão de trabalho	6,2 bar
(Ø) interno do tubo	10 mm
Consumo médio de ar	240 l/min
Peso	4,8 kg

3/4"	kg	€	1	019280023
	4,8	810,00		

## 1928K4

jogo de uma chave pneumática de impacto com quatro chaves de caixa, série longa

- Dispositivo de impulso "Pin Clutch"

3/4"

CE



Rotação em vazio	4,000 rpm
Torque máx.	1.493 Nm
Capacidade parafuso	Cl 8.8 M27 ● 41 mm
Capacidade parafuso	Cl 12.9 M24 ● 36 mm
Entrada de ar	3/8" GAS BSP
Pressão de trabalho	6,2 bar
(Ø) interno do tubo	10 mm
Consumo médio de ar	260 l/min
Peso chave de impacto pneumática	5,2 kg

3/4"	kg	€	1	019280104
	9,3	770,00		
410x330x106 mm				

## 1928XM

chave de impacto reversível compacta

- Dispositivo de impacto duplo
- Incrivelmente compacta e potente
- Comando de inversão com uma mão
- Três níveis de aperto reguláveis
- Exaustão através do punho

3/4"

CE



Rotação no vazio	4,800 rpm
Binário máx.	1.600 Nm
Capacidade parafuso	Cl 8.8 M27 ● 41 mm
Capacidade parafuso	Cl 12.9 M24 ● 36 mm
Entrada de ar	3/8" GAS
Pressão de trabalho	6.2 bar
Ø interno do tubo	10 mm
Consumo médio de ar	175 l/min
Peso	2.9 kg

3/4"	kg	€	1	019280030
	2,9	525,00		



## 1928P

chave de impacto reversível, em material compósito

• Mecanismo de impacto duplo



Rotações em vazio	5,000 rpm
Binário máx.	2,100 Nm
Capacidade do parafuso	CI 8.8 M30 ● 46 mm
Capacidade do parafuso	CI 12.9 M27 ● 41 mm
Entrada de ar	3/8" GAS
Pressão de trabalho	6.2 bar
Ø interno do tubo	10 mm
Consumo médio de ar	221 l/min
Peso	3.7 kg

3/4"	kg	€	1	019280006
3,7		1.040,00		

## 1930PA

chave de impacto reversível

• Mecanismo de impacto duplo



Velocidade	3,500 rpm
Binário máx.	2,445 Nm
Capacidade do parafuso	CI 8.8 M36 ● 55 mm
Capacidade do parafuso	CI 12.9 M30 ● 46 mm
Entrada de ar	1/2" GAS
Pressão de trabalho	6,2 bar
Diâm. interno do tubo	13 mm
Consumo médio de ar	350 l/min
Peso	9,6 kg

1"	kg	€	1	019300032
9,6		1.130,00		

## 1930A

chave de impacto reversível

• Dispositivo de impacto duplo



Velocidade em vazio	4,000 rpm
Binário máx.	2,445 Nm
Capacidade parafuso	CI 8.8 M36 ● 55 mm
Capacidade parafuso	CI 12.9 M30 ● 46 mm
Entrada de ar	1/2" GAS
Pressão de trabalho	6,2 bar
(Ø) interno do tubo	13 mm
Consumo médio de ar	460 l/min
Peso	9,5 kg

1"	kg	€	1	019300036
9,5		1.150,00		

## 1930LH

chave de impacto reversível

• Dispositivo de impacto duplo

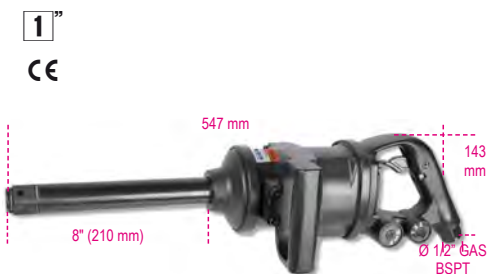

Rotação em vazio	6,000 rpm
Torque máx.	2,441 Nm
Capacidade parafuso	CI 8.8 M36 ● 55 mm
Capacidade parafuso	CI 12.9 M30 ● 46 mm
Entrada de ar	1/2" GAS
Pressão de trabalho	6,2 bar
Ø interno do tubo	13 mm
Consumo médio de ar	280 l/min
Peso	7,1 kg

1"	kg	€	1	019300030
7,1		1.170,00		

## 1930LA

chave pneumática de impacto reversível

• Dispositivo de impacto duplo



Rotação em vazio	4,000 rpm
Torque máx.	2,445 Nm
Capacidade parafuso	CI 8.8 M36 ● 55 mm
Capacidade parafuso	CI 12.9 M30 ● 46 mm
Entrada de ar	1/2" GAS
Pressão de trabalho	6,2 bar
(Ø) interno do tubo	13 mm
Consumo médio de ar	460 l/min
Peso	10,6 kg

1"	kg	€	1	019300037
10,6		1.190,00		



## 1930HLA

chave de pancada reversível

• Mecanismo de impacto duplo

1" CE



Rotação em vazio	3,000 rpm
Torque máx.	3.661 Nm
Capacidade parafuso	Cl 8.8 M42 ● 65 mm
Capacidade parafuso	Cl 12.9 M33 ● 50 mm
Entrada de ar	1/2" GAS
Pressão de trabalho	6,2 bar
(Ø) interno do tubo	13 mm
Consumo médio de ar	460 l/min
Peso	16,4 kg

1 16,4 kg 1.640,00 € 1 019300040

## 1931CD6

berbequim pneumático reversível, em material composto

CE



Rotação em vazio	2,600 rpm
Capacidade da bucha	1÷6 mm
Potência	0,23 kW
Rosca do veio	3/8" - 24UNF
Entrada de ar	1/4" GAS
Pressão de trabalho	6,2 bar
(Ø) interno do tubo	8 mm
Consumo médio de ar	130 l/min
Peso	0,6 kg

0,6 kg 241,00 € 1 019310006

## 1931CD13

berbequim pneumático reversível, em material composto

CE



Rotação em vazio	800 rpm
Capacidade da bucha	1,0÷13 mm
Potência	0,38 kW
Rosca do veio	1/2" - 20UNC
Entrada de ar	1/4" GAS
Pressão de trabalho	6,2 bar
(Ø) interno do tubo	10 mm
Consumo médio de ar	170 l/min
Peso	1,3 kg

1,3 kg 322,00 € 1 019310013

## 1930ZL

chave de pancada reversível

• Mecanismo de impacto duplo

1 1/2" CE



Rotação em vazio	3,000 rpm
Torque máx.	4.068 Nm
Capacidade parafuso	Cl 8.8 M42 ● 65 mm
Capacidade parafuso	Cl 12.9 M36 ● 55 mm
Entrada de ar	1/2" GAS
Pressão de trabalho	6,2 bar
(Ø) interno do tubo	13 mm
Consumo médio de ar	480 l/min
Peso	15 kg

1 1/2 15 kg 2.070,00 € 1 019300070

## 1931CD10

berbequim pneumático reversível, em material composto

CE



Rotação em vazio	1,800 rpm
Capacidade da bucha	1÷10 mm
Potência	0,38 kW
Rosca do veio	3/8" - 24UNF
Entrada de ar	1/4" GAS
Pressão de trabalho	6,2 bar
(Ø) interno do tubo	10 mm
Consumo médio de ar	170 l/min
Peso	1 kg

1,0 kg 217,00 € 1 019310010

## 1931AN10

berbequim pneumático angular reversível

CE



Rotação em vazio	1,400 rpm
Capacidade da bucha	1÷10 mm
Potência	0,38 kW
Rosca do veio	3/8" - 24UNF
Entrada de ar	1/4" GAS
Pressão de trabalho	6,2 bar
(Ø) interno do tubo	10 mm
Consumo médio de ar	150 l/min
Peso	1,1 kg

1,1 kg 241,00 € 1 019310030

## 1932B10

berbequim pneumático reversível



Rotação em vazio	1,800 rpm
Capacidade da bucha	1÷10 mm
Potência	0,44 kW
Rosca do veio	3/8" - 24UNF
Entrada de ar	1/4" GAS
Pressão de trabalho	6,2 bar
(Ø) interno do tubo	10 mm
Consumo médio de ar	160 l/min
Peso	1,2 kg

kg 1,2 € 173,00 1 019320040

## 1932B13

berbequim pneumático reversível



Rotação em vazio	400 rpm
Capacidade da bucha	1,5÷13 mm
Potência	0,34 kW
Rosca do veio	1/2" - 20UNC
Consumo de ar	1/4" GAS
Pressão de trabalho	6,2 bar
Ø interno do tubo	10 mm
Consumo médio de ar	180 l/min
Peso	1,6 kg

kg 1,6 € 258,00 1 019320004

## 1933ILH

retificadora pneumática longa de alta potência

• Bucha, Ø 3 mm e 6 mm

CE



Velocidade em vazio	20,000 rpm
Capacidade da bucha	3 - 6 mm
Potência	0,75 kW
Entrada de ar	1/4" GAS
Pressão de trabalho	6,2 bar
Ø interno do tubo	10 mm
Consumo médio de ar	370 l/min
Peso	1,2 kg

kg 1,2 € 368,00 1 019330011

## 1933AN90-H

rebarbadora pneumática de alta potência

• Bucha, Ø 3 mm e 6 mm

CE



Velocidade em vazio	15,000 rpm
Capacidade da bucha	3 - 6 mm
Potência	0,75 kW
Entrada de ar	1/4" GAS
Pressão de trabalho	6,2 bar
Ø interno do tubo	10 mm
Consumo médio de ar	370 l/min
Peso	1,1 kg

kg 1,1 € 368,00 1 019330021

## 1932RS13

berbequim pneumático reversível



Rotação em vazio	750 rpm
Capacidade da bucha	1,5÷13 mm
Potência	0,55 kW
Rosca do veio	3/8" - 24UNF
Entrada de ar	1/4" GAS
Pressão de trabalho	6,2 bar
(Ø) interno do tubo	10 mm
Consumo médio de ar	160 l/min
Peso	1,4 kg

kg 1,4 € 219,00 1 019320043

## 1933IH

retificadora pneumática de alta potência

• Bucha, Ø 3 mm e 6 mm

CE



Velocidade em vazio	20,000 rpm
Capacidade da bucha	3 - 6 mm
Potência	0,75 kW
Entrada de ar	1/4" GAS
Pressão de trabalho	6,2 bar
Ø interno do tubo	10 mm
Consumo médio de ar	370 l/min
Peso	800 g

g 800 € 196,00 1 019330006

## 1933

retificadora pneumática

• Pinça de Ø 3 mm e 6 mm

CE



Rotação em vazio	25,000 rpm
Capacidade da pinça	3 - 6 mm
Potência	0,20 kW
Entrada de ar	1/4" GAS
Pressão de trabalho	6,2 bar
(Ø) interno do tubo	10 mm
Consumo médio de ar	230 l/min
Peso	380 g

g 380 € 129,00 1 019330001





## 1933I

rectificadora pneumática

- Bucha coilectora, Ø 3 mm e 6 mm

CE



<b>Rotação em vazio</b>	20,000 rpm
<b>Capacidade da bucha</b>	3 - 6 mm
<b>Potência</b>	0,38 kW
<b>Entrada de ar</b>	1/4" GAS
<b>Pressão de trabalho</b>	6,2 bar
<b>(Ø) interno do tubo</b>	10 mm
<b>Consumo médio de ar</b>	260 l/min
<b>Peso</b>	670 g

670 g € 146,00 1 019330005

## 1933L

rectificadora pneumática longa

- Bucha coilectora, Ø 3 mm e 6 mm

CE



<b>Rotação em vazio</b>	25,000 rpm
<b>Capacidade da bucha</b>	3 - 6 mm
<b>Potência</b>	0,20 kW
<b>Entrada de ar</b>	1/4" GAS
<b>Pressão de trabalho</b>	6,2 bar
<b>(Ø) interno do tubo</b>	10 mm
<b>Consumo médio de ar</b>	270 l/min
<b>Peso</b>	670 g

670 g € 164,00 1 019330015

## 1933IL

rectificadora de veio longo

- Bucha coilectora, Ø 3 mm e 6 mm

CE



<b>Rotação em vazio</b>	20,000 rpm
<b>Capacidade da bucha</b>	3 - 6 mm
<b>Potência</b>	0,38 kW
<b>Entrada de ar</b>	1/4" GAS
<b>Pressão de trabalho</b>	6,2 bar
<b>(Ø) interno do tubo</b>	10 mm
<b>Consumo médio de ar</b>	113 l/min
<b>Peso</b>	1,4 kg

1,4 kg € 199,00 1 019330010

## 1933AN90

rectificadora pneumática angular

- Bucha coilectora, Ø 3 mm e 6 mm

CE



<b>Rotação em vazio</b>	20,000 rpm
<b>Capacidade da bucha</b>	3 - 6 mm
<b>Potência</b>	0,20 kW
<b>Entrada de ar</b>	1/4" GAS
<b>Pressão de trabalho</b>	6,2 bar
<b>(Ø) interno do tubo</b>	10 mm
<b>Consumo médio de ar</b>	230 l/min
<b>Peso</b>	510 g

510 g € 164,00 1 019330020

## 1934BV

rectificadora de baixa rotação para pneus

- Bucha coilectora, Ø 3 mm e 6 mm

CE



<b>Velocidade</b>	3,700 rpm
<b>Capacidade da bucha</b>	3 - 6 mm
<b>Potência</b>	0,37 kW
<b>Entrada de ar</b>	1/4" GAS
<b>Pressão de trabalho</b>	6,2 bar
<b>Diâm. interno do tubo</b>	10 mm
<b>Consumo médio de ar</b>	113 l/min
<b>Peso</b>	0,84 kg

840 g € 178,00 1 019340000

## 1934MAV

micro rectificadora

CE



<b>Velocidade</b>	56,000 rpm
<b>Capacidade da bucha</b>	3 mm
<b>Potência</b>	0,04 kW
<b>Entrada de ar</b>	1/4" GAS BSPT
<b>Pressão de trabalho</b>	6,2 bar
<b>Diâm. interno do tubo</b>	4,5 mm
<b>Consumo médio de ar</b>	115 l/min
<b>Peso</b>	0,2 kg

205 g € 152,00 1 019340010

## 1934MAV70

micro-rectificadora de alta rotação

CE



<b>Velocidade</b>	70,000 rpm
<b>Capacidade da bucha</b>	3 mm
<b>Potência</b>	0,08 kW
<b>Entrada de ar</b>	1/4" GAS BSPT
<b>Pressão de trabalho</b>	6,2 bar
<b>Diâm. interno do tubo</b>	4,5 mm
<b>Consumo médio de ar</b>	115 l/min
<b>Peso</b>	0,21 kg

210 g € 253,00 1 019340030



## 1935F

aparafusadora pneumática reversível



Rotação em vazio	800 rpm
Torque máximo	4-16 Nm
Capacidade parafuso	6-9 M
Quadra	1/4"
Entrada de ar	1/4" GAS
Pressão de trabalho	6,2 bar
Ø interno do tubo	10 mm
Consumo médio de ar	150 l/min
Peso	1,3 kg

kg	1,3	€	241,00	1	019350045
----	-----	---	--------	---	-----------

## 1936/4A

rebarbadora



Rotações em vazio	11,000 rpm
Dimensões do disco	115 mm
Potência	0,66 kW
Rosca do veio	M14
Entrada de ar	1/4" GAS
Pressão de trabalho	6,2 bar
Ø interno do tubo	10 mm
Consumo médio de ar	390 l/min
Peso	1,77 kg

kg	1,8	€	397,00	1	019360024
----	-----	---	--------	---	-----------

## 1936/5A

rebarbadora pneumática



Rotações em vazio	10,000 rpm
Dimensões do disco	125 mm
Potência	0,66 kW
Rosca do veio	M14
Entrada de ar	1/4" GAS
Pressão de trabalho	6,2 bar
Ø interno do tubo	10 mm
Consumo médio de ar	390 l/min
Peso	1,9 kg

kg	1,9	€	397,00	1	019360025
----	-----	---	--------	---	-----------

## 1936/7A

rebarbadora pneumática



Rotações em vazio	7,600 rpm
Dimensões do disco	180 mm
Potência	1,3 kW
Rosca do veio	M14
Entrada de ar	3/8" GAS
Pressão de trabalho	6,2 bar
Ø interno do tubo	13 mm
Consumo médio de ar	906 l/min
Peso	2,7 kg

kg	2,7	€	585,00	1	019360027
----	-----	---	--------	---	-----------

## 1937

Lixadeira de disco orbital, isenta de lubrificação, em material compósito

• Diâmetro orbital: 5 mm



Oscilações em vazio	12,000 rpm
Potência	0,18 kW
Diâmetro do disco	150 mm
Diâmetro orbital	5 mm
Rosca do veio	5/16"-24
Entrada de ar	1/4" GAS
Pressão de trabalho	6,2 bar
Ø interno do tubo	10 mm
Consumo médio de ar	170 l/min
Peso	0,86 kg

kg	0,86	€	419,00	1	019370001
----	------	---	--------	---	-----------

## 1937R/P

prato 6 furos, Ø 150 mm, para ref. 1937



1937R/P	€	43,50	1	019370002
---------	---	-------	---	-----------

## 1937KC

mini lixadeira roto-orbital

- Diâmetro orbital 4 mm
- 2 discos de lixar (Ø 50 mm e Ø 75 mm)
- 10 discos de lixa abrasiva (Ø 50 mm), grão 400, 600, 800
- 10 discos de lixa abrasiva (Ø 75 mm), grão 400, 600, 800



Velocidade livre	15000
Potência	0,25
Dimensões disco	50 - 75
Rosca do veio	M6 x 1,0
Entrada de ar	1/4"
Pressão de trabalho	6,2 bar
Dimensão interna tubo (Ø)	10
Consumo médio de ar	79
Peso lixadeira	0,64
Peso do kit	1,4

kg	1,4	€	240,00	1	019370171
----	-----	---	--------	---	-----------



## 1937C...

discos de lixa abrasiva para artigo 1937KC



Ø mm	P	€	kg	1937C...
50	400	14,40	1	019370175
50	600	14,40	1	019370176
50	800	14,40	1	019370177
75	400	18,20	1	019370178
75	600	18,20	1	019370179
75	800	18,20	1	019370180

\* Preços para 10 unidades

## 1937KL

mini polidora

- Disco de polir (Ø 75 mm)
- 2 esponjas de polimento (Ø 90 mm) - 1937/KL-DSB, 1937/KL-DSG
- Disco de polir em lâ (Ø 90 mm) - 1937/KL-DLA

CE



Velocidade livre	3,200 rpm
Potência	0,25 kW
Dimensões disco	75 mm
Rosca do veio	M6
Entrada de ar	1/4" GAS
Pressão de trabalho	6,2 bar
Dimensão interna tubo (Ø)	10 mm
Consumo médio de ar	91 l/min
Peso polidora	0,75 kg
Peso do kit	1,8 kg

kg	€	kg	1937KL-D
1,8	261,00	1	019370161

## 1937KL-D

acessórios para artigo 1937KL



Ø mm	€	kg	1937KL-D
1937KL-DLA 90	23,60	1	019370164
1937KL-DSB 90	23,60	1	019370165
1937KL-DSG 90	23,60	1	019370166

## 1937K...

pratos para artigos 1937KC e 1937KL



Ø mm	1937KC	1937KL	€	kg	1937K...
1937KC-RP 50	•		26,00	1	019370173
1937KL-RP 75		•	31,00	1	019370163

## 1937M

Lixadeira multiusos com 16 acessórios

CE



Rotações em vazio	3,500 rpm
Potência	0,34 kW
Entrada de ar	1/4" GAS
Pressão de trabalho	6,2 bar
(Ø) interno do tubo	10 mm
Consumo médio de ar	113 l/min
Peso lixadeira	1,5 kg
Peso kit	4,5 kg

kg	€	kg	1937M-01÷11
4,5	725,00	1	019370011

458x495x116 mm

## 1937M-01÷11

acessórios para ref. 1937M



L mm	1937M-	€	kg	1937M-
1937M-01 30		27,00	1	019370101
1937M-02 30		27,00	1	019370102
1937M-03 11		23,60	1	019370103
1937M-04 23		23,60	1	019370104
1937M-05 11		23,60	1	019370105
1937M-06 23		23,60	1	019370106
* 1937M-07 16		65,00	1	019370107
1937M-08 13	07	23,60	1	019370108
1937M-09 26	07	23,60	1	019370109
1937M-10 11	03, 05	23,60	1	019370110
1937M-11 23	01, 02, 04, 06	23,60	1	019370111

\* Os preços indicados são para 6 unidades

## 1937N10

Lixadeira de cinta pneumática, 10 mm

CE



Rotações em vazio	20,000 rpm
Potência	0,37 kW
Dimensões da cinta	10x330 mm
Entrada de ar	1/4" GAS
Pressão de trabalho	6,2 bar
(Ø) interno do tubo	10 mm
Consumo médio de ar	374 l/min
Peso	0,9 kg

kg	€	kg	1937N10
0,9	282,00	1	019370041

## 1937N10-GR

cinta para ref. 1937N10



P	€	kg	1937N10-GR
1937N10-GR60 60	29,50	1	019370146
1937N10-GR80 80	29,50	1	019370148
1937N10-GR100 100	29,50	1	019370150
1937N10-GR120 120	29,50	1	019370152

Os preços indicados são para 10 unidades

## 1937N20

lixadeira pneumática de cinta 20 mm

CE



Rotações em vazio	16,000 rpm
Potência	0,45 kW
Tamanho da cinta	20x520 mm
Entrada de ar	1/4" GAS
Pressão de trabalho	6,2 bar
(Ø) interno do tubo	10 mm
Consumo médio de ar	400 l/min
Peso	1,6 kg

kg	€	kg	1937N20
1,6	328,00	1	019370051



## 1937N20-GR

cinta para ref. 1937N20



	P	€		
1937N20-GR60	60	39,00	1	019370156
1937N20-GR80	80	39,00	1	019370158
1937N20-GR100	100	39,00	1	019370160
1937N20-GR120	120	39,00	1	019370162

Os preços indicados são para 10 unidades

## 1938

Removedor de pára-brisas

• Fornecido com 1 espátula plana 57 mm



Oscilações/minuto	20,000
Entrada de ar	1/4" GAS
Pressão de trabalho	6,2 bar
Ø interno do tubo	6,5 mm
Consumo médio de ar	200 l/min
Peso	1,0 kg

kg	€		
1,0	221,00	1	019380021

## 1938R/L

espátulas para removedor de pára-brisas

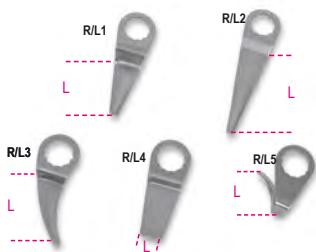

	L mm	€		
1938R/L1	57	18,80	1	019380041
1938R/L2	90	34,50	1	019380042
1938R/L3	30	21,00	1	019380043
1938R/L4	8	29,50	1	019380044
1938R/L5	36	34,00	1	019380045

## 1938R/S5

jogo de 5 espátulas para item 1938

	€		
1938R/S5	138,00	1	019380055

## 1940

martelo burilador pneumático

• Fornecido com mola de fixação e retentor de segurança para buris sextavados



Golpes por minuto	3,500
Encaixe do buril	Ø 11 mm
Dimensões do pistão	19 mm
Curso do pistão	67 mm
Entrada de ar	1/4" GAS
Pressão de trabalho	6,2 bar
Ø interno do tubo	8 mm
Consumo médio de ar	240 l/min
Peso	1,9 kg

kg	€		
1,9	178,00	1	019400001

## 1940/C6

martelo pneumático com 5 escopros e acessórios

- Para cortar chapa metálica, ferrolhos e peças, remoção de escória de soldadura, rebites, gesso e azulejos
- Jogo fornecido em estojo de ferramentas ABS incluindo:
  - 1 martelo pneumático item 1940
  - 1 escopro plano item 1940SN
  - 1 escopro de demolição item 1940ST
  - 1 escopro ponta redonda item 1940SD
  - 1 escopro biselado item 1940SPS
  - 1 escopro corte de chapa 1940SDT
  - 1 mola de não-retorno item 1940MT
  - 1 retenção de baioneta para escopros sextavados



Impactos por minuto	3.500
Encabadouro do escopro	Ø 11 mm
Dimensão do pistão	19 mm
Curso do pistão	67 mm
Entrada de ar	1/4" GAS
Pressão de trabalho	6,2 bar
Ø interno do tubo	8 mm
Consumo médio de ar	240 l/min
Peso	3,3 kg

kg	€		
3,3	252,00	1	019400000

320x240x90 mm

## 1940MT

mola de fixação para ref. 1940



	€		
1940MT	11,60	5	019400110

## 1940S...

buris para martelo 1940



	€		
1940SN	14,30	5	019400020
1940ST	14,30	5	019400021
1940SD	14,30	5	019400022
1940SPS	14,30	5	019400023
1940SDT	14,30	5	019400024

## 1940/S5

jogo de 5 buris para 1940



	€		
1940/S5	65,00	1	019400030

## 1940E10

martelo pneumático

- Compatível com escopros com encabadouro 10 mm sextavado
- Fornecido com mola e encabadouro de baioneta



Impactos por minuto	2,900
Encabadouro do escopro	Ø 10 mm
Dimensão do pistão	19 mm
Curso do pistão	67 mm
Entrada de ar	1/4" GAS
Pressão de trabalho	6,2 bar
Ø interno do tubo	10 mm
Consumo médio de ar	76 l/min
Peso	1,7 kg

kg	€		
1,7	196,00	1	019400010

## 1940E10/MT

mola de retenção sobresselente para artigo 1940E10



1940E10/MT € 1,53 5 019400112

## 1940E10/S...

escopros para martelos pneumáticos 1940E10



	€		
1940E10/SN	9,90	5	019400040
1940E10/ST	9,90	5	019400041
1940E10/SD	9,90	5	019400042
1940E10/SPS	9,90	5	019400043
1940E10/SDT	9,90	5	019400044

## 1940E10/S5

jogo de 5 escopros para martelos pneumáticos 1940E10



1940E10/S5 € 49,50 1 019400050

## 1942A

serra pneumática



Oscilações por minuto	10.000
Curso	10 mm
Entrada de ar	1/4" GAS BSP
Pressão de trabalho	6,2 bar
Ø interno do tubo	8 mm
Consumo médio de ar	75 l/min
Peso	550 g

550 g € 295,00 1 019420000

## 1942LR

lâminas bimetálicas para serra pneumática 1942A



1942LR € 6,90 5 019420032

## 1944A

martelo de agulhas axial

CE



Impactos por minuto	3.800
Alcance	33 mm
Nº de agulhas	19
Dimensões da agulha (Ø)	3 mm
Entrada de ar	1/4" GAS
Pressão de trabalho	6,2 bar
Dimensão interna do tubo (Ø)	10 mm
Consumo de ar	85 l/min
Peso	2,8 kg

2,8 kg € 333,00 1 019440011

## 1944N

Martelo de agulhas



Impactos por minuto	3800
Comprimento	33 mm
Nº de agulhas	19
Tamanho da agulha (Ø)	3 mm
Entrada de ar	1/4" GAS
Pressão de trabalho	6,2 bar
Tamanho interno da mangueira (Ø)	8 mm
Consumo de ar	85 l/min
Peso	2,7 kg

2,7 kg € 425,00 1 019440002

## 1944AR

jogo de agulhas para martelo de agulhas refª. 1944N, 1944A



	Ø mm	n.	€		
1944AR 2	2	29	43,50	1	019440015
1944AR 3	3	19	34,00	1	019440005

## 1944PA

Placas de agulha para itens 1944N e 1944A



	Ø mm	N. Aghi	€		
1944PA 2	2	29	48,00	1	019440016
1944PA 3	3	19	36,50	1	019440006

## 1945S

Agrafadora

• Agrafes tipo 80, seção comprimento de 0.95 x 0.65 mm (tamanho 21); 4-16 mm; largura: 12,8 mm



Capacidade	157 unid.
Entrada de ar	1/4" GAS
Pressão de trabalho	4.2 - 7 bar
Tamanho interno da mangueira (Ø)	8 mm
Consumo de ar (7 bar)	0,34 l/cycle
Peso	0,87 kg

0,9 kg € 181,00 1 019450000

## 1945S/G...

agrafes tipo 80, seção 0.95x0.65 mm (calibre 21), largura 12.8 mm, para item 1945S



	L mm	€		
• 1945S/G 4	4	16,90	1	019450004
1945S/G 6	6	6,70	1	019450006
1945S/G 8	8	7,20	1	019450008
1945S/G 10	10	8,10	1	019450010
1945S/G 12	12	9,00	1	019450012
1945S/G 14	14	9,70	1	019450014
1945S/G 16	16	10,70	1	019450016

Os preços indicados referem-se a 5.000 unid.  
• Os preços indicados referem-se a 10.000 unid.



## 1945P

Pistola para pinos

- Utiliza pinos tipo B6, Ø 0.64 mm (tamanho 23), comprimento: 12 - 35 mm



Capacidade	145 unid.
Entrada de ar	1/4" GAS
Pressão de trabalho	4 - 7 bar
Tamanho interno da mangueira (Ø)	8 mm
Consumo de ar (7 bar)	0.27 l/cycle
Peso	0.87 kg

kg	€	1	019450100
0,87	289,00		

## 1945P/S...

pinos tipo B6, Ø 0.64 mm (calibre 23), para item 1945P

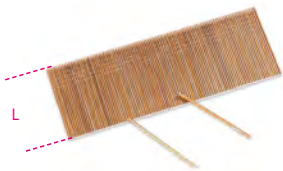

	L mm	€	1	019450112
1945P/S 12	12	7,90		
1945P/S 15	15	8,60		
1945P/S 18	18	9,40		
1945P/S 20	20	10,90		
1945P/S 21	21	11,00		
1945P/S 22	22	11,40		
1945P/S 25	25	12,20		
1945P/S 30	30	13,90		
1945P/S 35	35	15,80		

Os preços indicados referem-se a 10.000 unid.

## 1946

rebitadora pneumática

- Fornecida com rebites e bicos intermutáveis de 2,4 - 3,2 - 4,0 - 4,8 mm



Potência de tracção	8000 N
Curso	14 mm
Capacidade máx. rebite	Ø alumínio 4,8 mm
Entrada de ar	1/4" GAS
Pressão de trabalho	6,2 bar
(Ø) interno do tubo	6 mm
Consumo médio de ar	1,2 l/ciclo
Peso	1,5 kg

kg	€	1	019460001
1,5	180,00		

## 1946C4,8

rebitadora

- Entrada de ar automática
- Fornecida montada para utilização com rebites de aço, aço inoxidável, alumínio e cobre com 2.4 - 3.2 - 4.0 - 4.8 mm



Potência de tracção	8,900 N
Extensão do curso	15 mm
Capacidade máx. do rebite	Aço inoxidável Ø 4.8 mm
Entrada de ar	1/4" GAS
Pressão de trabalho	6,2 bar
Dimens. interna do tubo (Ø)	10 mm
Consumo de ar	2.6 l/ciclo
Peso	1.5 kg

kg	€	1	019460006
1,5	560,00		



## 1946C7,8

rebitadora

- Entrada de ar automática
- Fornecida montada para utilização com rebites de aço, aço inoxidável, alumínio e cobre com 4.8 - 5.6 - 6.4 - 7.8 mm



Potência de tracção	16,900 N
Extensão do curso	22.5 mm
Capacidade máx. do rebite	Aço inoxidável Ø 7.8 mm
Entrada de ar	1/4" GAS
Pressão de trabalho	6,2 bar
Dimens. interna do tubo (Ø)	10 mm
Consumo de ar	4.9 l/ciclo
Peso	1.8 kg

kg	€	1	019460008
1,8	885,00		

## 1946C/T...

Cabeças de rebites



	Ø mm	€	1	019460016
1946C/T4,8	4,8	34,00		
1946C/T6,4	6,4	34,00		

## 1946KF

rebitadora pneumática para rebites roscados

- Fornecida montada para rebites roscados em aço, aço inox, alumínio e cobre, M4, M5, M6, M8



Força de tracção	14,235 N
Curso	7 mm
Capacidade máxima rebite	Aço inox Ø, M8
Entrada de ar	1/4" GAS
Pressão de trabalho	6,2 bar
Ø interno do tubo	10 mm
Consumo de ar	2.1 l/ciclo
Peso máquina	2.1 kg
Peso kit	3.4 kg

kg	€	1	019460012
3,4	1.860,00		



## 1946KF/M...

bicos de substituição para rebitoradora ref. 1946KF



	€	kg	g
1946KF/M4	62,50	1	019460124
1946KF/M5	62,50	1	019460125
1946KF/M6	62,50	1	019460126
1946KF/M8	60,00	1	019460128

## 1947

pistola de colagem

- Pistola pneumática para silicone de média densidade, adesivo e cola
- Adequada para bastões standard (210 x 50 mm), duros e macios



Dimensões do tubo	210x50 mm
Capacidade do cartucho	350 ml
Entrada de ar	1/4" GAS
Pressão de trabalho	4.8 bar
(Ø) interno do tubo	10 mm
Consumo médio de ar	120 l/min
Peso	1,1 kg

kg	€	g
1,1	63,00	1 019470001

## 1947H

pistola para isolantes

- Pistola pneumática para silicone e isolantes em cartuchos standard de plástico ou alumínio
- Suporta cartuchos standard (215/218 mm x 50/51 mm), rígidos e moles
- Válvula de redução da pressão integrada



Dimensões do tubo	210x50 mm
Capacidade do cartucho	300/310 ml
Entrada de ar	1/4" GAS
Pressão de trabalho	4 + 8 bar
(Ø) interno do tubo	2.5 mm
Consumo médio de ar	120 l/min
Peso	750 g

g	€	g
750	219,00	1 019470011

## 1947G

bomba de massa pneumática, com extensão e bico

- Estrutura robusta em alumínio fundido
- Punho ergonómico com inclinação perfeita para trabalhar em espaços apertados
- Válvula em latão para maior vida útil
- Capacidade: 500cc ou cartuchos de 400g
- Dimensões do tubo: 54 (interior) x 260 mm
- Entrada de ar: 1/4" GAS
- Pressão de trabalho: 4+10 bar
- Peso: 1.9 kg



kg	€	g
1,9	155,00	1 019470051

## 1947G2

pistola de massa 2 em 1

- Para fornecimento contínuo e não contínuo
- Cabeça em alumínio fundido
- Punho ergonómico
- Capacidade para cartuchos de 400 g ou massa até 500 cc



Dimensão do tubo	54 (interior) x 276 mm
Entrada de ar	1/4" GAS BSP
Pressão de trabalho	3+10 bar
Peso	2,2 kg

kg	€	g
2,2	159,00	1 019470060



## 1948

caneta de gravação

- Permite a gravação em aço, aço inox, alumínio, vidro, pedra e cerâmica



Golpes por minuto	3,500 ÷ 3,800
Dureza máxima	60 HRC
Entrada de ar	1/4" GAS
Pressão de trabalho	6.2 bar
Consumo médio de ar	50 l/min
Peso	150 g

g	€	g
150	290,00	1 019480001

## 1948PR

ponta pastilhada em tungsténio para item 1948

- Dureza máx.: 60 HRC



kg	€	g
0,001	110,00	1 019480005

## 1949XS

soprador progressivo

- Em liga leve
- O fluxo de ar pode ser ajustado através da rotação da cabeça

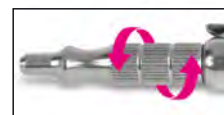

Rosca	1/4" GAS
Pressão de trabalho	3-8 bar
Pressão máx. de trabalho	10 bar
Temperatura de trabalho	-20 °C ÷ 70 T38°C
Peso	20 g

g	€	g
20	6,30	25 019490025

## 1949U5

soprador progressivo com 5 bicos

- Em material composto anti-desgaste, à prova de embates
- 3 bicos em aço, 100/160/320 mm, pontas protetoras em borracha anti-riscos
- 1 bico "Turbo" em nylon reforçado com fibra de vidro com ponta de segurança
- 1 bico giratório, 100 mm, em nylon reforçado com fibra de vidro
- Com sistema de fixação rápida



Ø 1/4" GAS BSPT

Insert roscado em latão  
Pressão de trabalho  
Pressão de trabalho máx.  
Consumo médio de ar  
Temperatura de trabalho  
Peso

1/4" GAS  
10 bar  
15 bar  
280 l/min  
-10°C ÷ 85°C  
93 g

93 g € 34,50 1 019490030

## 1949U5/A

bico em aço, 100 mm, com ponta protetora em borracha anti-riscos, para item 1949U5 - 1949P



1949U5/A € 7,00 1 019490131

## 1949U5/B

bico em aço, 160 mm, com ponta protetora em borracha anti-riscos, para item 1949U5 - 1949P



1949U5/B € 7,10 1 019490132

## 1949U5/C

bico em aço, 320 mm, com ponta protetora em borracha anti-riscos, para item 1949U5 - 1949P



1949U5/C € 9,10 1 019490133

## 1949U5/D

bico giratório, 100 mm, em nylon reforçado com fibra de vidro, para item 1949U5 - 1949P



1949U5/D € 6,70 1 019490134

## 1949U5/E

bico "Turbo" em nylon reforçado com fibra de vidro, com ponta de segurança



1949U5/E € 3,25 1 019490135

## 1949U5/F

bico plano, em forma de leque, em nylon reforçado com fibra de vidro, para itens 1949U5 e 1949P



1949U5/F € 4,20 1 019490136

## 1949U5/G

bico OSHA, em nylon reforçado com fibra de vidro, para itens 1949U5 e 1949P



1949U5/G € 3,15 1 019490137

## 1949BC

soprador progressivo com bico em borracha

- Corpo em material composto, anti-choque
- Bico substituível em borracha

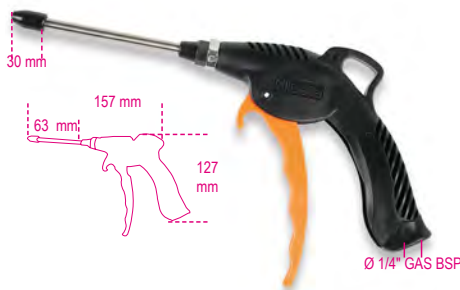

Insert roscado em latão  
Pressão de trabalho  
Pressão de trabalho máx.  
Consumo médio de ar  
Temperatura de trabalho  
Peso

1/4" GAS  
6-8 bar  
15 bar  
87 l/min  
-20°C ÷ 70°C  
120 g

120 g € 17,00 1 019490022

## 1949BC/RUL

5 bicos em borracha longos, para artigo 1949BC



1949BC/RUL € 21,00 1 019490123

## 1949P

mini soprador progressivo

- Em material composto anti-desgaste, à prova de embates
- Sistema de fixação rápida do bico
- O fluxo de ar pode ser ajustado por rotação da porca



Insert roscado em latão  
Pressão de trabalho  
Pressão de trabalho máx.  
Consumo de ar médio  
Temperatura  
Peso

1/4" GAS  
6-8 bar  
15 bar  
280 l/min  
-10°C ÷ 85°C  
70 g

70 g € 22,30 1 019490031

## 1949T

soprador progressivo telescópico

- Corpo em material composto, anti-desgaste e anti-choque
- Tubo telescópico giratório em aço: 165 mm ÷ 300 mm

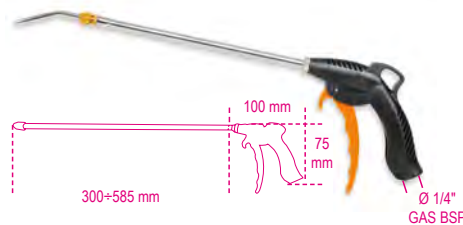

Insert roscado em latão  
Pressão de trabalho  
Pressão de trabalho máx.  
Consumo médio de ar  
Pressão de trabalho  
Peso

1/4" GAS  
6-8 bar  
15 bar  
144 l/min  
-20°C ÷ 70°C  
190 g

190 g € 27,00 1 019490040



## 1949F2

pistola de ar progressiva

- Em plástico compósito resistente, anti-impacto, à prova de riscos, com isolamento térmico
- Válvula e alavanca especial que permitem a abertura progressiva do circuito, otimizando o fluxo de ar
- Ponta com cone de segurança em plástico para manuseamento seguro quando não se encontra em funcionamento



Inserção roscada em bronze	1/4" GÁS
Pressão de trabalho	4-8 bar
Pressão de trabalho máxima	12 bar
Temperatura de trabalho	-20 °C + 70 °C
Peso	125 g

g	€	1	019490028
125	15,70		

## 1949GPA

punho de encher pneus

- corpo revestido a borracha anti-impacto
- alavanca de operação em metal
- pressão de trabalho: 0,5÷12 bar, 7÷174 psi
- botão despressurização
- dispositivo medição pressão
- comprimento do tubo: 58 cm
- rotação do tubo 360°
- entrada de ar 1/4"



bar	psi	€	1	019490018
0,5÷12	7÷174	101,00		

## 1949DGT/2

punho de encher pneus digital

- corpo revestido a borracha anti-impacto
- alavanca de operação em metal
- pressão de trabalho: 0,5÷12 bar, 7÷174 psi
- 4 unidades de medida, bar/psi/kpa/kgf
- monitor LCD iluminado
- resolução: 0.05 bar
- funcionamento automático desliga após 1.5 minuto
- comprimento do tubo: 58 cm
- rotação do tubo 360°
- alimentação: 2 pilhas AAA
- entrada de ar 1/4"



bar	psi	€	1	019490021
0,5÷12	7÷174	120,00		

## 1949M

punho para medir a pressão dos pneus



bar	psi	g	€	1	019490400
0÷4	5÷60	280	70,50		

## 1949R

pistola de ar para limpeza de radiadores

os 5 furos perpendiculares ao punho permitem a remoção de sujidade dos radiadores



L	mm	€	1	019490050
600	6	79,50		

## 1950BZK

destalonador de pneus

- punho secundário com operação por botão ajuda a segurar a ferramenta durante a utilização
- capacidade do depósito: 18 l
- pressão de funcionamento: 3-8 bar
- pressão máxima do depósito: 16 bar
- válvula de alívio de pressão
- medidor com escala graduada
- entrada de plástico para evitar danos na jante



L	Ø	€	1	019500078
440	290	363,00		

## 1950BZK/T

destalonador de pneus de veículos pesados

O destalonador de pneus da Beta está equipado com um punho secundário com operação por botão ajuda a segurar a ferramenta durante a utilização.



- Características:
- Capacidade do depósito: 36 l
  - Pressão de funcionamento: 3-8 bar
  - Pressão máxima do depósito: 16 bar
  - Válvula de alívio de pressão
  - Medidor com escala graduada
  - Entrada de plástico para evitar danos na jante

L	Ø	€	1	019500080
560	290	453,00		



## 1950GPP

punho de encher pneus portátil com carga automática e manual, com pistola de enchimento

Um equipamento indispensável para as oficinas e estações de serviço, adequado para testar e repar a pressão dos pneus através de uma pistola de enchimento com manómetro de dupla escala (bar/psi). A carga pode ser automática (através da tomada de parede) ou manual (através da válvula de enchimento)



Características técnicas:

- Capacidade do depósito: 10 l
- Pressão máxima do depósito: 16 bar (232 psi)
- Manómetro do depósito, Ø 50 mm: 0÷16 bar (232 psi)
- Manómetro de funcionamento: 0÷16 bar (232 psi)
- Comprimento do tubo: 1550 mm
- Peso vazio: 9.3 kg

H	Ø	bar	l	€	g	1
mm	mm					
1950GPP	700	300	0÷16	10	306,00	1 019500050

## 1951

pistola de limpeza

- Para limpeza de estofos, tapetes e assentos de automóveis e botas



Capacidade do reservatório	1/4" GAS
Entrada de ar	6,2 bar
Pressão de trabalho	8 mm
Ø interno do tubo	110 l/min
Consumo médio de ar	650 g
Peso	650 g

g	€	g	1
650	137,00	1	019510051

## 1951A

pistola de limpeza com aspiração

- Para limpeza de estofos, tapetes e assentos de automóveis e botas
- Para utilização com detergentes adequados
- Reservatório de 1L
- Equipada com torneira para dispensar líquido do reservatório
- Equipada com tubo corrugado, 1,8 m de comp.



Capacidade do reservatório	1 l
Entrada de ar	1/4" GAS
Pressão de trabalho	6.2 bar
Ø interno do tubo	8 mm
Consumo médio de ar	120 l/min
Peso	800 g

g	€	g	1
800	221,00	1	019510101

## 1952

pistola de pintura profissional

- Corpo em alumínio fundido com revestimento niquelado preto
- Reservatório nylon com dispositivo antigota, rosca BSP 3/8M
- Rosca corpo: rosca cilíndrica de gás 1/4" BSP
- Regulador de pressão e fluxo de ar
- Regulador do jato de pulverização, redondo ou em leque
- Regulador da quantidade de tinta
- Fornecido com chave de serviço para operações de manutenção



Ø	mm	€	g	1
1952 1,2	1,2	146,00	1	019520012
1952 1,5	1,5	146,00	1	019520015
1952 1,8	1,8	146,00	1	019520018
1952 2,0	2,0	146,00	1	019520020

## 1900S

enrolador de tubo automático, corpo em plástico anti-impacto, para utilização com ar comprimido ou água

- pressão máx. de funcionamento: 15 bar
- tubo de poliuretano
- estrutura em polipropileno
- dispositivo para fixar automaticamente o tubo no comprimento necessário
- mecanismo de cremalheira pode ser desativado para manter o cabo puxado
- amplitude de temperatura: -5 °C / +50 °C
- fornecido com suporte giratório 180° e um suporte adicional de ligação rápida

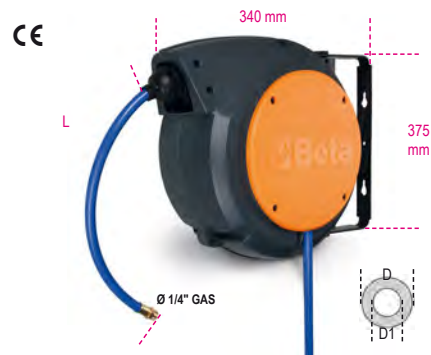

D1xD	L	Ø GAS	mm	m	BSP	€	g	1
1900S 8X10	8x12	10	10	10	1/4"	194,00	1	019000080

## 1900M

enrolador de tubo automático, corpo em plástico anti-impacto, para utilização com ar comprimido ou água

- pressão máx. de funcionamento: 15 bar
- tubo em poliuretano
- corpo em polipropileno
- dispositivo para fixar automaticamente o tubo no comprimento necessário
- mecanismo de cremalheira pode ser desativado para manter o tubo puxado
- amplitude de temperatura: -5 °C / +50 °C
- fornecido com suporte giratório 180° e um suporte adicional de ligação rápida



D1xD	L	Ø GAS	mm	m	BSP	€	g	1
1900M8X15	8x12	15	15	15	1/4"	265,00	1	019000085
1900M10X15	10x14	15	15	15	3/8"	276,00	1	019000115
1900M12X15	12x16	15	15	15	1/2"	360,00	1	019000125

## 1914

tubo espiral em poliuretano, 98 Shore, extensível

• Pressão de trabalho máxima: 12 bar

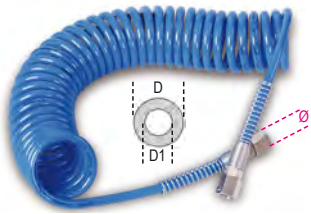

L m	DxD1 mm	Ø GAS BSP	€	📦	📄
4	5x8	1/4"	23,20	1	019140054
6	5x8	1/4"	27,00	1	019140056
10	5x8	1/4"	34,50	1	019140060

## 1915B

tubo espiral em poliuretano, 95 Shore, extensível até 9 m

• Pressão de trabalho máxima: 10 bar

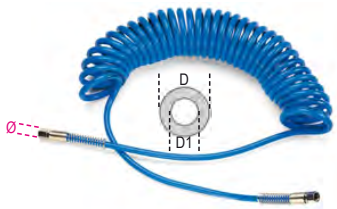

D1xD mm	Ø GAS BSP	€	📦	📄
6,5x10	1/4"	39,50	1	019150011
8x12	1/4"	47,50	1	019150012

## 1915C

tubo espiral em poliuretano, 95 Shore, extensível até 12 m

• Pressão de trabalho máxima: 10 bar

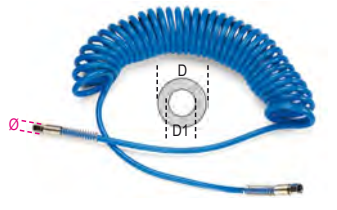

D1xD mm	Ø GAS BSP	€	📦	📄
6,5x10	1/4"	47,50	1	019150014
8x12	1/4"	58,50	1	019150015

## 1915C/L

tubo espiral em poliuretano, 95 Shore, extensível até 15 m

• Pressão de trabalho máxima: 10 bar



D1xD mm	Ø GAS BSP	€	📦	📄
8x12	1/4"	75,00	1	019150115

## 1915D

tubo em poliuretano, 95 Shore, com 9 m

• Pressão de trabalho máxima: 15 bar

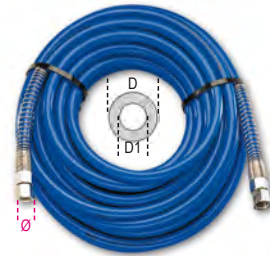

D1xD mm	Ø GAS BSP	€	📦	📄
8x12	1/4"	47,50	1	019150017

## 1915E

tubo em poliuretano, 95 Shore, com 12 m

• Pressão de trabalho máxima: 15 bar



D1xD mm	Ø GAS BSP	€	📦	📄
8x12	1/4"	63,00	1	019150019
11x16	3/8"	94,00	1	019150020

## 1915E/XL

tubo em poliuretano, 95 Shore, com 50 m

• Pressão de trabalho máxima: 15 bar



D1xD mm	Ø GAS BSP	€	📦	📄
8x12	1/4"	216,00	1	019150519
11x16	3/8"	362,00	1	019150520

## 1916I

uniões rápidas de perfil italiano  
rosca macho, cilíndricas (BSP)



Ø GAS BSP	€	📦	📄
1/4"	2,75	5	019160001
3/8"	3,10	5	019160002

## 1916G

uniões rápidas de perfil europeu  
rosca macho, afuniladas (BSPT)



Ø GAS BSPT	€	📦	📄
1/4"	2,75	5	019160005
3/8"	3,60	5	019160010
1/2"	4,00	5	019160012

## 1916GF

Engates rápidos, perfil europeu, rosca fêmea,  
cônico (BSPT)



Ø GAS BSP	€	📦	📄
1/4"	2,75	5	019160055
3/8"	3,10	5	019160060

## 1916GFE

uniões rápidas, perfil Europeu,  
rosca fêmea, afunilada (BSPT)



Ø GAS BSPT	€	📦	📄
1/4"	2,75	5	019160075
3/8"	3,60	5	019160082
1/2"	4,00	5	019160084

## 1916JM

Engates rápidos de perfil asiático, rosca  
macho cônica (BSPT)



Ø GAS BSPT	€	📦	📄
1/4"	3,85	1	019160406
3/8"	4,00	1	019160410

## 1916JF

Engates rápidos, perfil europeu, rosca fêmea,  
cilíndrico (BSP)



Ø GAS BSP	€	📦	📄
1/4"	3,85	1	019160456
3/8"	4,00	1	019160460

## 1917M

uniões de esferas universais, borracha à prova de impacto, rosca macho, cilíndricas (BSP)

• Adequadas para uniões 1916I e 1916G



Ø GAS BSP	€	🛒	📄
1/4"	9,90	5	019170001
3/8"	9,90	5	019170003
1/2"	10,60	5	019170004

## 1917F

Engates rápidos de esfera universal com borracha à prova de choque e fêmea com rosca cilíndrica (BSP)

• Engates 1916I e 1916G



Ø GAS BSP	€	🛒	📄
1/4"	10,30	5	019170005
3/8"	9,90	5	019170010
1/2"	10,90	5	019170014

## 1917JM

Engates rápidos de esferas, perfil asiático, rosca macho, cilíndrica (BSP)



Ø GAS BSP	€	🛒	📄
1/4"	16,40	1	019170406
3/8"	16,40	1	019170410
1/2"	17,70	1	019170412

## 1917JF

Engates rápidos de esferas, perfil asiático, rosca fêmea, cilíndrica (BSP)



Ø GAS BSP	€	🛒	📄
1/4"	16,40	1	019170456
3/8"	16,40	1	019170460

## 1917RG

Engate universal rotativo

- Fabricado em alumínio, rosca fêmea, cilíndrica (BSP) rosca macho, cilíndrica (BSP)
- Combina todos os engates com perfis italianos e europeus
- Gira livremente, mesmo sem área conectada



Ø GAS BSP	€	🛒	📄
1/4"	21,40	1	019170252

## 1917SP

uniões rápidas de esfera universal, com encaixe para mangueira de borracha



D1xD mm	€	🛒	📄
6x14	10,60	5	019170206
8x17	11,00	5	019170208
10x19	12,60	5	019170210

## 1918

Adaptador extremidade da mangueira, rosca macho



D1 mm	Ø GAS BSP	€	🛒	📄
8	1/4"	2,53	3	019180118
10	1/4"	2,53	3	019180120
10	3/8"	2,88	3	019180130
12	3/8"	2,96	3	019180132
10	1/2"	3,90	3	019180140
12	1/2"	4,00	3	019180142

## 1918N

uniões roscadas (BSPT)



Ø GAS	Ø1 GAS	€	🛒	📄
1/4"	1/4"	2,53	5	019180300

## 1918R

uniões redutoras roscadas (BSPT)



Ø GAS	Ø1 GAS	€	🛒	📄
1/4"	3/8"	2,88	5	019180200
3/8"	1/2"	3,90	5	019180210

# Beta

## 1919FE1/4

filtro regulador lubrificador



Entrada/saída de ar 1/4" GAS BSPT  
Entrada manómetro de pressão 1/8" GAS BSPT  
Capacidade pneumática máx. 750 l/min  
Pressão máx. 9,5 bar  
Pressão de trabalho 0,5 - 8,5 bar  
Temperatura de trabalho 5 - 60 °C  
Capacidade do filtro 5 micron  
Capacidade recip. 15 cc ar / 25 cc óleo  
Peso 700 g

g	€	🛒	📄
700	99,00	1	019190200

## 1919RB-FE1/4

jogo de copos de substituição para artigo 1919FE1/4



€	🛒	📄
21,50	1	019190210

## 1919RF-FE1/4

elemento filtrante de substituição para artigo 1919FE1/4



€	🛒	📄
5,90	1	019190230



## 1919RM-FE1/4

manômetro de substituição  
para artigo 1919FE1/4



1919RM-FE € 12,70 1 019190220

## 1919F1/4

filtro regulador lubrificador



Entrada/saída de ar 1/4" GAS BSPT  
Capacidade pneumática máx. 1000 l/min  
Pressão máx. 9,5 bar  
Pressão de trabalho 0,5 - 8,5 bar  
Temperatura de trabalho 5 - 60 °C  
Capacidade do filtro 5 microns  
Capacidade recip. 60 cc ar / 90 cc óleo  
Peso 1.3 kg

kg 1,3 € 156,00 1 019190250

## 1919F3/8

filtro regulador lubrificador



Entrada/saída de ar 3/8" GAS BSPT  
Capacidade pneumática máx. 1350 l/min  
Pressão máx. 9,5 bar  
Pressão de trabalho 0,5 - 8,5 bar  
Temperatura de trabalho 5 - 60 °C  
Capacidade do filtro 5 microns  
Capacidade recip. 60 cc ar / 90 cc óleo  
Peso 1.3 kg

kg 1,3 € 156,00 1 019190350

## 1919F1/2

filtro regulador lubrificador



Entrada/saída de ar 1/2" GAS BSPT  
Capacidade pneumática máx. 2500 l/min  
Pressão máx. 9,5 bar  
Pressão de trabalho 0,5 - 8,5 bar  
Temperatura de trabalho 5 - 60 °C  
Capacidade do filtro 5 microns  
Capacidade recip. 60 cc ar / 90 cc óleo  
Peso 1.3 kg

kg 1,3 € 156,00 1 019190450

## 1919RB-F

jogo de copos de substituição  
para artigos 1919F - 1/4", 3/8" e 1/2"



1919RB-F € 27,50 1 019190510

## 1919RF-F

elemento filtrante de substituição  
para artigos 1919F - 1/4", 3/8" e 1/2"



1919RF-F € 10,90 1 019190530

## 1919RM-F

manômetro de substituição  
para artigos 1919F - 1/4", 3/8" e 1/2"



1919RM-F € 16,40 1 019190520

## 1919ML

mini lubrificador de linha



Ø mm	L mm	Ø mm	€	1	019190030
1/4"	63	36	20,10	1	019190030
3/8"	63	36	21,80	1	019190032

## 1919SC

mini separador de condensados



Ø mm	L mm	Ø mm	€	1	019190035
1/4"	80	40	26,00	1	019190035

## 1919L

óleo de lubrificação ISO 32

Densidade a 20°C 875 Kg/m<sup>3</sup>  
Viscosidade 40°C 32 cSt  
Inflamabilidade COC 210°C



cc 500 € 17,70 5 019190050





# JOGOS DE FERRAMENTAS, MALAS, CAIXAS E CARROS



		MALAS						CAIXAS										CARROS					
		2009N/BV	2028/VV	2029/VV	2032/TV	2033L/VV	2036/TV	C5   C6T   C9MT	C7	C8	C10	C9   C10S   C11   CP15L	C16   CP17   CP17L	C12	C14	CP15	C18	C19   C19L	C20	C20L	C41S	C41H	C42H
pieces																							
5914VU/M	Manutenção em geral	109												509									
5915VU/0	Manutenção em geral	35					511																
5915VU/1	Manutenção em geral	45						511	511	511	511	511			511	511							
5915VU/2	Manutenção em geral	49					512		511	511	511	511			512			512	512				
5915VU/3	Manutenção em geral	74					512		512	512	512	512					512	512	512				
5915VU/4	Manutenção em geral	80																513	513				
5915VU/5	Manutenção em geral	111											513								513	513	513
5915VU/AS	Manutenção em geral	68							514									514	514				
5940SBK	Reparação de motocicletas e bicicletas	125																			539	539	539
5941VU/M	Manutenção em geral	64																				540	
5980EL/A	Electrónica	57	525		525	525																	
5980EL/B	Electrónica	98		526		526	526																
5980ET/A	Electrotécnica	70	523		523								523										
5980ET/B	Electrotécnica	64		524		524	524						524										
5980ID/1	Canalização	24	527					527															
5980MQ	Electrotécnica	46		524																			
5980U/BIKE	Reparação de motocicletas e bicicletas	90											517							517			



**FUNCIONALIDADE**

**ROBUSTEZ**

**DURABILIDADE**

### MOCHILAS E SACOS DE FERRAMENTAS EM TECIDO TÉCNICO

Estas são as pedras basilares da gama Beta de sacos e mochilas em tecido.

As mochilas e sacos de ferramentas Beta são fabricados em tecido técnico resistente à abrasão e desgaste, com costuras e fundo reforçados, o que se traduz em durabilidade e fiabilidade.

Cada saco tem características especiais, concebidas para diferentes utilizações e otimização do espaço: bolsos com fecho de correr, pegas telescópicas, proteções das rodas, alças reforçadas e porta-documentos transparentes são apenas algumas das particularidades de cada saco e mochila.

A atenção aos detalhes, à variedade e ao transporte totalmente seguro das ferramentas garantem que estes produtos são ideais em qualquer situação de trabalho.



### CAIXAS DE FERRAMENTAS EM POLIPROPILENO

A Beta oferece uma ampla gama de estojos para qualquer necessidade! Caixas e carros de ferramentas Beta são construídos em polipropileno robusto, compacto, à prova de embates, anti-corrosão, desenhados para suportar utilizações pesadas - por ex., a baixas temperaturas. Escolha o melhor produto para as suas necessidades de trabalho, desde o carro de ferramentas clássico, passando pela versão com rodas para fácil transporte, pelas versões com fechos TSA para liberdade total em viagem, até às versões em alumínio ou impermeáveis.

A maior parte das caixas e carros de ferramentas Beta estão disponíveis também em combinação com jogos de ferramentas para diferentes necessidades, em função do campo de aplicação: eletrónica, hidráulica, náutica e manutenção.

### 2001/B26

estojo de tecido com sortido de 26 ferramentas



2001/B26 € 266,00 1 020010215

55	6x7 - 8x9 - 10x11 - 12x13 - 14x15 - 16x17 mm	n.
96N/SC9	1,5 - 2 - 2,5 - 3 - 4 - 5 - 6 - 8 - 10 mm	9
1044N	250 mm	1
1128BMX	147 mm	1
1150	180 mm	1
1201E	3x75 - 4x100 - 5,5x150 mm	3
1202E	PH1x80 - PH2x100 mm	2
1370	300 g	1
1692	2 m	1
1770A	9 mm	1

2001/BV € 62,00 1 020010051

### 2001/BZV

estojo de ferramentas em tecido técnico resistente

- Pega superior dupla para ótimo transporte
- Bolso frontal de grandes dimensões para documentos, com fecho
- Faixa de velcro na parte traseira, para fixação do estojo à pega do carro
- 20 compartimentos para ferramentas (6 bolsos e 14 bandas elásticas)
- Laçadas para martelo
- Disponível com alça de ombro C9/RT (a encomendar separadamente)



2001/BZV € 56,50 1 020010151

380x290x60 mm - 890 g







## 2001/BZ24 MQ

estojo dobrável com conjunto de 24 ferramentas, para eletricitas



2001/BZ24 MQ € 387,00 1 020010154

	n.
1128BMX 147 mm	1
1150MQ 180 mm	1
42 8-10-13-17-19 mm	5
1274MQ 3x100 - 4x100 - 5,5x125 mm	3
1272MQ PH0x60 - PH1x80 - PH2x100 mm	3
96BP/SC9 1,5-2-2,5-3-4-5-6-8-10 mm	9
1253	1
1082MQ 160 mm	1
380x290x60 mm	

## 2001/BZ27 VU

estojo dobrável com conjunto de 27 ferramentas, para utilização universal



2001/BZ27 VU € 320,00 1 020010157

	n.
1128BMX 147 mm	1
1150 180 mm	1
42 7-8-10-13-17-19 mm	6
1201E 3x75 - 4x100 - 5,5x150 mm	3
1202E PH0x60- PH1x80 - PH2x100 mm	3
96/SC9 1,5-2-2,5-3-4-5-6-8-10 mm	9
1370 300 g	1
1048N 250 mm	1
1692/5 5 m	1
1771 18 mm	1
380x290x60 mm	

## 2002/BV6

bolsa para ferramentas em poliéster, vazia

- Com 6 compartimentos para ferramentas de diferentes tamanhos
- Alça central em tecido reforçado facilita o transporte
- Com aba interior para evitar que as ferramentas saiam
- Costuras reforçadas em todo o perímetro
- Fecho duplo em Velcro



2002/BV6 € 10,00 1 020020000

175x240 mm - 83 g

## 2002/BVL6

bolsa para ferramentas em poliéster, vazia

- Com 6 compartimentos para ferramentas de diferentes tamanhos
- Alça central em tecido reforçado facilita o transporte
- Com aba interior para evitar que as ferramentas saiam
- Costuras reforçadas em todo o perímetro
- Fecho duplo em Velcro



2002/BVL6 € 12,70 1 020020010

220x290 mm - 120 g

## 2002/BV7-ZIP

bolsa para ferramentas em poliéster, vazia

- Com 7 compartimentos para ferramentas de diferentes tamanhos e pequeno bolso para ferramentas com fecho de correr
- Alça central em tecido reforçado facilita o transporte
- Com aba interior para evitar que as ferramentas saiam
- Costuras reforçadas em todo o perímetro
- Fecho duplo em Velcro



2002/BV7-ZIP € 22,70 1 020020060

335x220 mm - 135 g

## 2002/BV8

bolsa para ferramentas em poliéster, vazia

- Com 8 compartimentos para ferramentas de diferentes tamanhos
- Alça central em tecido reforçado facilita o transporte
- Com aba interior para evitar que as ferramentas saiam
- Costuras reforçadas em todo o perímetro
- Fecho duplo em Velcro



2002/BV8 € 12,70 1 020020020

395x360 mm - 225 g

## 2002/BV9

bolsa para ferramentas em poliéster, vazia

- Com 9 compartimentos para ferramentas de diferentes tamanhos
- Alça central em tecido reforçado facilita o transporte
- Com aba interior para evitar que as ferramentas saiam
- Costuras reforçadas em todo o perímetro
- Fecho duplo em Velcro



2002/BV9 € 12,70 1 020020030

325x290 mm - 155 g

## 2002/BV12

bolsa para ferramentas em poliéster, vazia

- Com 12 compartimentos para ferramentas de diferentes tamanhos
- Alça central em tecido reforçado facilita o transporte
- Com aba interior para evitar que as ferramentas saiam
- Costuras reforçadas em todo o perímetro
- Fecho duplo em Velcro



2002/BV12 € 21,10 1 020020040

650x355 mm - 310 g

## 2002/BV13

bolsa para ferramentas em poliéster, vazia

- Com 13 compartimentos para ferramentas de diferentes tamanhos
- Alça central em tecido reforçado facilita o transporte
- Com aba interior para evitar que as ferramentas saiam
- Costuras reforçadas em todo o perímetro
- Fecho duplo em Velcro



2002/BV13 € 12,70 1 020020050

330x190 mm - 110 g

## 2002/BV42

bolsa para ferramentas em poliéster resistente, vazia

- Com 42 compartimentos para ferramentas de diferentes dimensões:
- 18 bandas elásticas e 24 bolsos, incluindo um com aba
- Pega central em tecido reforçado para fácil transporte
- Com anéis metálicos para suspensão
- Costuras de reforço em todo o perímetro da bolsa
- Fecho resistente com fivela dupla



2002/BV42 € 31,00 1 020020070

595x540 mm - 490 g

## 2005MPU

bolsa para ferramentas, vazia, em nylon, com cinto

- Cinco bolsos grandes para ferramentas
- Um bolso frontal para tesoura
- Fivela com gancho tipo carabina para fita adesiva
- Cinto ajustável (70 ÷ 120 cm)

Dimensões: 155x285x80 mm



2005MPU € 32,50 1 020050060

155x285x80 mm

## 2005MPU/E

bolsa para ferramentas com sortido de 5 ferramentas



2005MPU/E € 106,00 1 020050065

- 1128BMX 147 mm
- 1150BM 180 mm
- 1201E 3,5x100 - 4x100 mm
- 1202E PH1x80 mm
- 155x285x80 mm

## 2005PA/D

bolsa para ferramentas, vazia, em nylon, com cinto



2005PA/D € 77,00 1 020050000

## 2005PA/E

bolsa para ferramentas, vazia, em nylon, com cinto

- Dois bolsos grandes com elásticos para ferramentas
- Dois bolsos frontais para tesouras
- Dois compartimentos laterais:
  - bolso esquerdo com gancho de metal resistente para fitas métricas
  - bolso direito duplo com bolsa com cordão e fecho de correr
- Fivela com gancho tipo carabina para fita adesiva
- Cinto ajustável (70 ÷ 120 cm)



2005PA/E € 51,50 1 020050030

260x250x190 mm

## 2005PA/ET

bolsa para ferramentas com sortido de 8 ferramentas para manutenção eletrotécnica



2005PA/ET € 209,00 1 020050035

- 1082MQ 160 160 mm
- 1128BMX 147 mm
- 1253
- 1272MQF PH1x80 - PH2x100
- 1274MQF 3,5x100 - 4,5x100
- 1639ESB BMESB1925NE
- 260x250x190 mm

## 2005PA/S

bolsa para ferramentas, vazia, em nylon, com cinto



2005PA/S € 38,50 1 020050020

280x76x264 mm

## 2009N/BV

estojo de manutenção em cabedal

Fabricado inteiramente em cabedal resistente, laterais reforçadas em alumínio.

Equipado com:

- alça
- fecho com fivela metálica
- base interior robusta feita em chapa de ferro galvanizado



2009N/BV € 325,00 1 020090200

530x220x190 mm



## 2005PA/U

bolsa para ferramentas com sortido de 17 ferramentas para utilização universal



2005PA/U € 208,00 1 020050040

96/SC9 1,5-2-2,5-3-4-5-6-8-10 mm

111E 200 mm

1048N 250 mm

1128BMX 147 mm

1201E 4x100 - 5,5x125 mm

1202E PH1x80 - PH2x100 mm

1692/3 3 m

260x250x190 mm

## 2028/VV

Caixa de ferramenta, de polipropileno

2 painéis de ferramentas  
Fundo interior com divisórias removíveis  
Fechadura de combinação dupla



2028/VV € 269,00 1 020280010

480x190x400 mm - 4,7 Kg

## 2028E

Mala com sortido de ferramentas de manutenção eletrônica e eletrotécnica



2028EL/A € 1.310,00 1 020281014

(2028/VV+5980EL/A)  
2028ET/A € 1.310,00 1 020281018

(2028/VV+5980ET/A)

## 2029/VV

mala para ferramentas, em polipropileno espesso,  
extremidades em alumínio

- 2 painéis para ferramentas
- Fundo com divisórias amovíveis e ajustáveis
- Fornecida com alça de ombro
- Dois fechos com chave



2029/VV € 385,00 1 020290000

480x227x408 mm - 6 Kg

## 2029E

malas de ferramentas com jogos de ferramentas para electrónica e manutenção electrotécnica



2029 BG MQ € 2.210,00 1 020291257

(2029/VV+5980MQ)

2029ET/B € 1.830,00 1 020291021

(2029/VV+5980ET/B)

2029EL/B € 1.850,00 1 020291017

(2029/VV+5980EL/B)



## 2029EM

mala com jogo de ferramentas para manutenção e reparação de veículos híbridos e elétricos



2029EM € 2.420,00 1 020290300

52MQ 7-8-9-10-11-12-13-14-15-16-17-19-22 mm

910MQ/B 6-7-10-12-13-17-19 mm

910MQ/TX TX25 - TX30 - TX40

910MQ/55

1048MQ 250 mm

1082MQ 160 mm

1128MQ 145 mm

1150MQ 180 mm

1162MQ 160 mm

1272MQ PH1 - PH2

1274MQ 2,5x75 - 3x100 - 4x100 - 5,5x125 - 6,5x150 mm

1760PT/N

1777MQ/U 190 mm

7109A A1 - A2

7109D D2 - D3

1997MQ/GM Gr. 10

## 2032/TV

carro para ferramentas, em plástico

- 2 painéis para ferramentas
- Bolso para ferramenta
- Fundo com componentes amovíveis



2032/TV € 520,00 1 020320110

450x200x400 mm - 3 Kg



## 2032/TE

carro com sortidos de ferramentas para trabalhos de manutenção electrónica e electrotécnica



2032TET/A 1.560,00 € 1 020321328  
(2032/TV+5980ET/A)

## 2033L/VV

mala de ferramentas, em alumínio, vazia

- Elevada resistência a impactos
- Acabamento anti-riscos
- Punho ergonómico revestido a borracha
- Fecho duplo com combinação

- 2 painéis de ferramentas com elásticos
- Base interior com divisórias amovíveis



2033L/VV 421,00 € 1 020330250  
470x203x373 mm - 6 Kg

## 2033L

mala de ferramentas em alumínio com sortido de ferramentas para manutenção electrónica e eletrotécnica



2033LEL/A 1.460,00 € 1 020331224  
(2033L/VV+5980EL/A)  
2033LEL/B 1.880,00 € 1 020331225  
(2033L/VV+5980EL/B)  
2033LET/B 1.860,00 € 1 020331237  
(2033L/VV+5980ET/B)

## 2036/TV

carro para ferramentas, em polipropileno espesso, extremidade em alumínio

- 2 painéis para ferramentas
- Pega telescópica
- Rodízios de esferas



2036/TV 610,00 € 1 020360000  
480x267x408 mm - 7,5 Kg

## 2036E

carro de ferramentas tipo trolley com jogos de ferramentas para electrónica e manutenção electrotécnica



2036TET/B 2.050,00 € 1 020361223  
(2036/TV+5980ET/B)  
2036EL/B 2.070,00 € 1 020361218  
(2036/TV+5980EL/B)

## 2037/TV

Mala tipo trolley, em polipropileno, com 4 rodas, vazia

- Altamente resistente ao choque. Adequada para transporte em aviões.
- 2 painéis de ferramentas amovíveis.
- Porta-documentos incorporado.
- 4 rodízios amovíveis para manipulação horizontal do carro.
- 2 tabuleiros incluídos.
- 2 fechaduras aprovadas pela TSA com chaves.
- Pega revestida a borracha.



2037/TV 755,00 € 1 020370000  
482x295x478 mm - 8,2 Kg

## 2038/TV

mala de ferramentas tipo trolley, em polipropileno espesso

- Elevada resistência a impactos
- Perfil vedante em alumínio
- 2 fechaduras aprovadas TSA com chaves
- 2 painéis de ferramentas amovíveis.
- Punho telescópico e rodas de grandes dimensões
- 2 punhos ergonómicos revestidos a borracha incluindo (1 punho lateral)
- Fundo espaçoso
- Bolsa porta-documentos
- 3 painéis de ferramentas interiores



2038/TV 995,00 € 1 020380000  
430x375x525 mm - 9 Kg



# Beta



## 2041UC

Jogo de 33 ferramentas em caixa



2041UC € 390,00 1 020410215

- 55 6x7 - 8x9 - 10x11 - 12x13 - 14x15 - 16x17 mm
- 96/SC9 1,5 - 2 - 2,5 - 3 - 4 - 5 - 6 - 8 - 10 mm
- 111E 200 mm
- 1048VN 250 mm
- 1128BMX 147 mm
- 1150 180 mm
- 1201E 2,5x50 - 3x75 - 4x100 - 5,5x100 - 6,5x150 mm
- 1202E PH0x60 - PH1x80 - PH2x100 mm
- 1370 300 g
- 1692 3m
- 1771 170 mm
- 1833S 70 Lumen / 140 mm
- 1639NS-N 25m
- 1696 200 mm
- 535x282x87 mm - 4,5 Kg

## 2051N

jogo de 55 ferramentas para manutenção naval com caixa em propileno anti-choque



2051N € 930,00 1 020510225

- 42 7 - 8 - 10 - 12 - 13 - 14 - 17 - 19 mm
- 55AS 3/8x7/16 - 1/2x9/16 - 5/8x11/16"
- 96/SC9  $\varnothing$ 1,5+10 mm
- 111E 200 mm
- 920A  $\varnothing$  10 - 12 - 13 - 14 - 17 - 19 mm
- 920AS  $\varnothing$  7/16 - 1/2 - 9/16 - 11/16 - 7/8"
- 920/22 255 mm -  $\square$ 1/2 -  $\blacksquare$ 1/2
- 920/25  $\square$ 1/2 -  $\blacksquare$ 1/2
- 920/42  $\blacksquare$ 1/2
- 920/55  $\blacksquare$ 1/2
- 956C  $\square$ 1/2 - 16 - 20,8 mm
- 1048BM 250 mm
- 1084BM 160 mm
- 1128BMX 147 mm
- 1150BM 180 mm
- 1166BM 160 mm
- 1201E  $\bullet$ 3x75 - 4x100 - 5,5x150 - 6,5x150 mm
- 1202E  $\bullet$ PH1x80 - PH2x100 mm
- 1390  $\varnothing$  35 mm
- 1490/2  $\varnothing$  max 240 mm
- 1737 145 mm
- 1778X
- BMN1436 3,6 x 140 mm
- BMESB1925NE 25 m
- 585x393x92 mm - 9 kg

## 2055HB

mala "Home Bag" com sortido de 24 ferramentas



2055HB € 236,00 1 020550215

- 55 6x7 - 8x9 - 10x11 - 12x13 mm
- 96N/SC9 1,5 - 2 - 2,5 - 3 - 4 - 5 - 6 - 8 - 10 mm
- 1128BMX 147 mm
- 1150 180 mm
- 1048VN 250 mm
- 1201E 3x75 - 4x100 - 5,5x100 mm
- 1202E PH0x60 - PH1x80 - PH2x100 mm
- 1370 300 g
- 1692 3m
- 373x275x70 mm - 3 Kg

## 2080/DS

caixa organizadora de ferramentas PEQUENA, com 15 compartimentos e 10 divisórias amovíveis

A solução perfeita para transportar pequenas peças, incluindo parafusos, porcas, anilhas, rebites e cavilhas.

- Tampa transparente resistente, concebida para impedir que as peças saiam dos compartimentos
- Divisórias amovíveis, para formar compartimentos de diferentes tamanhos, conforme as necessidades individuais
- Podem ser empilhadas e encaixadas umas nas outras
- Dimensões interiores: 345 x 290 mm



2080/DS € 24,00 4 020800210  
375x315x65 mm - 760 g

## 2080/DL

Caixa organizadora de ferramentas GRANDE, com 15 compartimentos e 8 divisórias amovíveis

A solução perfeita para transportar pequenas peças, incluindo parafusos, porcas, anilhas, rebites e cavilhas.

- Tampa transparente resistente, concebida para impedir que as peças saiam dos compartimentos
- Divisórias amovíveis, para formar compartimentos de diferentes tamanhos, conforme as necessidades individuais
- Podem ser empilhadas e encaixadas umas nas outras
- Dimensões interiores: 410 x 300 mm



2080/DL € 28,50 3 020800211  
440x330x75 mm - 970 g

## 2080/V17

caixa organizadora de ferramentas com 17 compartimentos amovíveis  
Indispensável para acomodar e transportar as peças pequenas de forma organizada e precisa.

- Tampa resistente, concebida para evitar que as peças saiam dos compartimentos
- Compartimentos de tamanhos diferentes:
  - pequeno: 5,1x4,6x5,9h cm
  - médio: 5,1x9,9x5,9h cm
  - grande: 10x9,9x5,9h cm
- Dimensões interiores: 310 x 255 mm



2080/V17 € 26,00 4 020800200  
335x285x65 mm - 750 g

## 2080/V6

estojo de ferramentas com 6 compartimentos  
amovíveis



2080/V6 € 44,00 1 020800060  
385x320x60 mm - 1,2 kg

## 2080/V6-U

estojo de ferramentas com 6 compartimentos  
amovíveis 2080/V6



2080/V6-U € 3,40 1 020800066  
90x60x50 mm

## 2080/V12

estojo de ferramentas com 12 compartimentos  
amovíveis



2080/V12 € 69,50 1 020800000  
300x145x330 mm - 1,8 kg

## 2080/V12-...

estojo de ferramentas com 12 compartimentos  
amovíveis



2080/V12-S € 4,25 3 020800013  
95x75x65 mm  
2080/V12-M € 6,40 2 020800015  
145x75x65 mm  
2080/V12-L € 11,10 1 020800020  
295x75x65 mm

## C3

mini saco de ferramentas, em tecido técnico

Características principais:

- 1 bolsa exterior frontal com fecho
- 2 bolsas laterais
- 1 bolsa traseira com fecho de velcro
- 1 painel de ferramentas interior amovível, com elásticos em ambos os lados
- porta USB para carregar dispositivos móveis
- Com alça para ombro



C3 € 74,50 1 021030000  
230x110x320 mm - 917 g

## C5S

mochila para ferramentas, em poliéster  
reforçado

- Pega dupla para sustentação firme e equilibrada
- Duas bolsas grandes exteriores frontais
- Duas bolsas interiores espaçosas, fitas adicionais com velcro para fecho
- Bolsa interna roll-up com 4 painéis
- Alças ajustáveis reforçadas
- Capacidade de carga máxima: 15 kg



C5S € 64,00 1 021050100  
310x120x390 mm - 0,9 Kg

## C5 - 2105

mochila para ferramentas, em tecido



C5 € 179,00 1 021050000  
2105VU/0 € 635,00 1 021051122  
(C5+5915VU/0)  
400x200x500 mm - 2,8 Kg



## C6T - 2106

mochila para ferramentas, em tecido, com rodas



C6T	€ 254,00	1	021060010
2106T/VU0 (C6T+5915VU/0)	€ 710,00	1	021061123
≡ 360x200x480 mm - 4,9 Kg			

## C7 - 2107

saco para ferramentas em tecido

- 2 painéis para ferramentas amovíveis
- Bolsa interior em PC
- 2 bolsas exteriores
- Base interior em plástico, com divisórias amovíveis



C7	€ 265,00	1	021070000
2107VU/2 (C7+5915VU/2)	€ 745,00	1	021071112
2107VU/3 (C7+5915VU/3)	€ 1.280,00	1	021071114
≡ 480x165x380 mm - 4 Kg			

## C7AT

saco para ferramentas em tecido técnico

- Características principais:
- em tecido técnico de elevada durabilidade
  - base reforçada com pés de borracha
  - pega superior dupla para manuseamento seguro e equilibrado
  - bolso frontal grande para documentos com fecho de correr e compartimento adicional com fecho duplo velcro + clipe
  - bolso lateral duplo com fecho em velcro
  - compartimento interno espaçoso com bolso adicional para documentos
  - Compartimento para PC e tablet com acolchoamento interior de proteção (tamanho do PC até L=370 mm, H=250 mm - 15")
  - abertura frontal com fecho de correr bidirecional para acesso rápido às ferramentas:
    - 29 compartimentos e 13 faixas elásticas para ferramentas na parte frontal;
    - 33 compartimentos para ferramentas na parte traseira.
  - fornecido com alça de ombro acolchoada ajustável



C7AT	€ 142,00	1	021070010
≡ 420x200x340 mm - 2,8 Kg			

## C8 - 2108

Mala de ferramentas tipo trolley em tecido high-tech

- Punho telescópico
- 2 painéis de ferramentas interiores amovíveis
- 2 bolsos exteriores frontais
- Pode ser equipada com caixa de ferramentas ref. C10S



C8	€ 299,00	1	021080000
2108VU/1 (C8+5915VU/1)	€ 850,00	1	021081022
≡ 470x280x380 mm - 5,5 Kg			

## C8B

mala de ferramentas tipo em tecido técnico, para eletricitistas

- Estrutura rígida
- Pega telescópica
- 4 rodízios
- 1 painel de ferramentas interior amovível
- Bolso frontal com porta-cartões
- Fundo duplo com tabuleiro
- 2 bolsos laterais exteriores
- 2 ganchos para regulação da alça
- Pega dobrável para fácil acesso às ferramentas
- Possibilidade de trancar cadeado não incluído)



C8B	€ 241,00	1	021080300
≡ 380x250x430 mm - 4,8 Kg			

## C9 - 2109

saco para ferramentas em tecido

- Base rígida
- Bolsos interiores e exteriores para ferramentas
- Bolso exterior com fecho eclair para maior segurança
- Bolso para objectos pessoais com cinta de segurança
- Fundo duplo
- Cordão duplo para níveis
- Alça de ombro para fácil transporte



C9	€ 145,00	1	021090000
2109VU/1 (C9+5915VU/1)	€ 700,00	1	021091022
2109VU/3 (C9+5915VU/3)	€ 1.160,00	1	021091024
≡ 550x280x320 mm - 2,6 Kg			

## C9/RT

correia de ombro para artigos C9 e C10



C9/RT € 18,80 1 021090900

## C9DA

saco para ferramentas com abertura grande

Características principais:

- em tecido técnico de elevada durabilidade
- base em plástico rígido, impermeável
- pega superior reforçada para manuseamento seguro
- bolso lateral duplo com fecho de velcro
- dois compartimentos laterais para ferramentas com aberturas grandes, para acesso rápido e perfeita visibilidade do conteúdo
- 22 compartimentos para ferramentas e compartimento adicional com fecho de correr na parte frontal
- 14 compartimentos para ferramentas e compartimento adicional com fecho de correr na parte traseira
- fornecido com alça de ombro acolchoada ajustável



C9DA € 115,00 1 021090005

420x220x310 mm - 2,4 Kg

## C9MT

saco para ferramentas, vazio

- revestimento em PVC resistente, impermeável
- costuras reforçadas em todo o perímetro
- fecho com duas fivelas
- pega interior dupla para manuseamento seguro e equilibrado
- bolsa para documentos com fecho de correr



C9MT € 102,00 1 021090200

450x180x200 mm - 1,4 Kg

## 2109MT ID/1

mala com jogo de 24 ferramentas para canalizadores



2109MT ID/1 € 730,00 1 021091026

(C9MT+5980ID/1)

- 111E 250 mm
- 332 Ø 3+28 mm
- 334 Ø 3+30 mm
- 342 Ø 0+42 mm
- 345SB2 140 mm
- 376 320-410 mm
- 1048N 175-250 mm
- 1128BMX 147 mm
- 1150GBM 180 mm
- 1201E 3x75-4x100-5,5x150-8x150 mm
- 1202E PH1x80-PH2x100
- 1370 500 g
- 1690F 2 m
- 1692/5 5 m
- 1696 200 mm
- 1719BMA...M 200 mm
- 1719BM/RL 200 mm
- 1725



## C9PT



C9PT 314

## C10 - 2110

saco para ferramentas em tecido

- Estrutura rígida
- Fundo duplo. Possibilidade de remoção para maior capacidade do saco.
- Pega inclinável para fácil acesso ao conteúdo
- Cintas elásticas para ferramentas e bolsos interiores e exteriores
- Pala de cobertura
- Tabuleiro para ferramentas incluído no fundo duplo



C10 € 182,00 1 021100000

2110VU/1 € 735,00 1 021101031

(C10+5915VU/1)

2110VU/3 € 1.200,00 1 021101034

(C10+5915VU/3)

2110VU/AS € 1.300,00 1 021101036

(C10+5915VU/AS)

520x220x250 mm - 3,3 Kg







## C10S - 2110S

saco para ferramentas em tecido

- Estrutura rígida
- Fundo duplo. Possibilidade de remoção para maior capacidade do saco.
- Pega inclinável para fácil acesso ao conteúdo
- Cintas elásticas para ferramentas e bolsos interiores e exteriores
- Pala de cobertura
- Tabuleiro para ferramentas incluído no fundo duplo



	€		
C10S	143,00	1	021100001
2110SVU/1 (C10S+5915VU/1)	695,00	1	021110141
2110SVU/3 (C10S+5915VU/3)	1.160,00	1	021110144

≡ 420x220x250 mm - 2,9 Kg

## C11 - 2111

caixa de ferramentas, em tecido



	€		
C11	106,00	1	021110000
2111VU/1 (C11+5915VU/1)	660,00	1	021111031
2111VU/3 (C11+5915VU/3)	1.120,00	1	021111034

≡ 410x230x250 mm - 1,8 Kg

## C12 - 2112

saco para ferramentas em tecido

- Painel de ferramentas interior amovível
- Elásticos para fixação das ferramentas e bolsas interiores e exteriores espaçosas
- Abertura frontal para acesso mais fácil ao conteúdo
- Base impermeável rígida com pés de borracha
- Pode ser utilizado com o trolley C8



	€		
C12	230,00	1	021120000
2112ET/A (C12+5980ET/A)	1.270,00	1	021121028
2112ET/B (C12+5980ET/B)	1.670,00	1	021121029
2112VU/5 (C12+5915VU/5)	1.520,00	1	021121056

≡ 500x270x350 mm - 5,3 Kg

## C13

mala de ferramentas com rodízios, em polipropileno resistente

- Adequada a utilização no exterior
- Resistente ao impacto e a agentes químicos
- Pode ser fechada a cadeado (cadeado não incluído)
- Fecho duplo
- Duas rodas para movimentação horizontal
- Com tabuleiro de ferramentas interior amovível e bloqueável em duas posições
- Placa de identificação



	€		
C13	380,00	1	021130000

≡ 806x350x467 mm - 7,2 Kg



## C14

mala de ferramentas tipo trolley (fornecida vazia), em polipropileno, com 4 gavetas

- Estrutura em polipropileno de injeção para maior resistência ao impacto
- A tampa de proteção frontal acomoda 4 gavetas amovíveis (470x255):  
1 gaveta 30 mm altura  
2 gavetas 60 mm altura  
1 gaveta 90 mm altura
- Fechadura centralizada frontal que permite trancar as tampas superior e frontal simultaneamente
- 2 pegas laterais
- 4 rodas traseiras resistentes
- Tabuleiro superior removível
- Painel de ferramentas embutido na tampa
- 3 tabuleiros
- Placa de identificação
- Fechadura TSA



	€		
C14	970,00	1	021140000
2114VU/M (C14+5914VU/M)	2.200,00	1	021141011

≡ 585x390x457 mm - 14,5 Kg

## CP15 - 2115

caixa de ferramentas, em plástico, com tabuleiros de ferramentas amovíveis

- 1 tabuleiro integrado na tampa
- 2 tabuleiros amovíveis com divisórias ajustáveis
- 1 tabuleiro interior com divisórias ajustáveis



	€		
CP15	56,50	1	021150201
2115PVU/1 (CP15+5915VU/1)	610,00	1	021151232
2115PVU/2 (CP15+5915VU/2)	540,00	1	021151234

≡ 445x240x250 mm - 2 Kg





### CP15L - 2115

caixa de ferramentas, série longa, em plástico, com tabuleiros de ferramentas amovíveis

- 3 tabuleiros integrados na tampa com divisórias ajustáveis
- 1 tabuleiro interior com divisórias ajustáveis



CP15L	76,50	1	021150202
2115PL-VU/1 (CP15L+5915VU/1)	630,00	1	021151242
2115PL-VU/3 (CP15L+5915VU/3)	1.090,00	1	021151245

558x277x270 mm - 2,9 Kg

### 2115PI/BIKE-HOME

Sortido de 28 ferramentas

Reparação de bicicletas



2115PI/BIKE-HOME	303,00	1	021150098
------------------	--------	---	-----------

- 96BP/SC9 1,5-2-2,5-3-4-5-6-8-10 mm
- 3935
- 3969K3
- 42 8-9-10-13-14 mm
- 42SLIM 15 mm
- 1082G 160 mm
- 1150G 180 mm
- 1201E 3x75 - 5,5x150 mm
- 1202E PH0x60 - PH2x100 mm
- 3991

BMESB1925NE 25 m

BMN1436 3,6 x 140 mm

558x277x270 mm - 4,3 kg

### 2115P L-MQ32

jogo 32 ferramentas isoladas para veículos híbridos, em estojo de plástico com tabuleiro em esponja suave



2115PL-MQ32	1.330,00	1	021150332
-------------	----------	---	-----------

920MQ/55A

89MQ 10-12 mm

850MQ 1/4"

861TX/A10 T7 - T8 - T9 - T10 - T15 - T20  
T25 - T27 - T30 - T40

920MQ/A 8-10-12-13-14-17-19 mm

920MQ/21 125mm

920MQ/22 250mm

1048MQ250 250mm

1150MQ 180mm

1164MQ160 160mm

1272MQ 4.5X80-6X100mm

1274MQ 3X100-4X100-5.5X125

1997MQ/GM Gr. 10

CP15L

### C16 - 2116

caixa de ferramentas, em plástico, com compartimentos interiores, vazia



C16	125,00	1	021160000
2116VU/1 (C16+5915VU/1)	680,00	1	021161102
2116VU/3 (C16+5915VU/3)	1.140,00	1	021161105

500x260x260 mm - 2,3 Kg



### CP17 - CP17L - 2117

caixa de ferramentas, feita de aço inoxidável e plástico, bandeja de carga removível



CP17  
500x200x220 mm



CP17L  
575x245x265 mm

CP17	105,00	1	021170500
2117P-VU/1 (CP17+5915VU/1)	660,00	1	021171042
2117P-VU/3 (CP17+5915VU/3)	1.120,00	1	021171045
CP17L	151,00	1	021170502
2117L-VU/1 (CP17L+5915VU/1)	705,00	1	021171142
2117PL-VU/3 (CP17L+5915VU/3)	1.170,00	1	021171145

### C18 - 2118

caixa para ferramenta em chapa metálica



C18	49,50	1	021180001
2118VU/1 (C18+5915VU/1)	605,00	1	021181032

450x200x100 mm - 2,1 Kg

## C19 - 2119 - C19L - 2119L

caixa extensível com três divisões em chapa metálica



C19

450x200x160 mm



C19L

550x200x160 mm

	€		
C19	65,50	1	021190001
2119VU/3 (C19+5915VU/3)	1.080,00	1	021191025
C19L	84,00	1	021190002
2119L-VU/3 (C19L+5915VU/3)	1.100,00	1	021191125

## C20 - C20L - 2120

caixa extensível com cinco divisões em chapa metálica



C20

450x200x210 mm



C20L

550x200x210 mm

	€		
C20	92,50	1	021200001
2120VU/2 (C20+5915VU/2)	575,00	1	021201061
2120VU/3 (C20+5915VU/3)	1.110,00	1	021201063
2120VU/4 (C20+5915VU/4)	1.410,00	1	021201064
2120VU/AS (C20+5915VU/AS)	1.210,00	1	021201068
C20L	101,00	1	021200002
2120L-VU/2 (C20L+5915VU/2)	585,00	1	021201161
2120L-VU/3 (C20L+5915VU/3)	1.120,00	1	021201163
2120L-VU/4 (C20L+5915VU/4)	1.420,00	1	021201164
2120L-VU/AS (C20L+5915VU/AS)	1.220,00	1	021201168

## C20TSS

Caixa de ferramentas extensível com 5 divisões, em axo inox AISI 304



	€		
C20TSS	321,00	1	021203001

450x200x210 mm - 4 Kg

## C22B

caixa de ferramentas metálica



C22B O

720x320x310 mm



C22BM O

850x360x350 mm



C22BL O

1010x410x400 mm

	€		
C22B-O	262,00	1	022000150
C22BM-O	301,00	1	022000160
C22BL-O	402,00	1	022000170

C22B O: 720x320x310 mm - 13 Kg  
 C22BM O: 850x360x350 mm - 20 Kg  
 C22BL O: 1.010x410x400 mm - 26 Kg

## C22W

caixa para ferramenta vazia, em chapa metálica, forrada, para uma maior protecção da ferramenta



C22W-O

690x300x360 mm



C22WL-O

990x300x360 mm

	€		
C22W-O	292,00	1	022000269
C22WL-O	379,00	1	022000299

C22W O: 690x300x360 mm - 15 Kg  
 C22WL O: 990x300x360 mm - 28 Kg

## C22P

baú para ferramentas para a construção civil, em chapa metálica

- Pegas retrácteis integradas,
- Sapatas elevadas para mobilização com porta-paletes,
- Fechadura dupla anti-roubo (não incluída)



C22PM O

915x540x430 mm



C22PL O

1220x720x615 mm

	€		
C22PM-O	780,00	1	022000240
C22PL-O	1.210,00	1	022000245

C22PM O: 915x540x430 mm - 39 Kg  
 C22PL O: 1.220x720x615 mm - 67 Kg





**Combo é o Sistema modular da Beta** constituído por **3 tipos distintos de malas de ferramentas** para manter o seu material de trabalho totalmente seguro e organizado.

As malas são facilmente encaixáveis entre si, através de um prático mecanismo de fecho lateral.

*O sistema Beta Combo C99 está em conformidade com a norma L-BOXX by Sortimo®.*

**C99**

BETA COMBO sistema modular

As malas de ferramentas são facilmente encaixáveis entre si, através de um prático mecanismo de fecho lateral.

Inclui:

- Trolley dobrável ultracompacto com pega telescópica C99P (485x520x1095 mm)
- Caixa de ferramentas em ABS, C99V1 (445x358x152 mm)
- Caixa de ferramentas em ABS, C99V2 (445x358x254 mm)
- Caixa de ferramentas em ABS, com 2 tabuleiros portáteis C99V3/2C (445x358x322 mm)



C99 € 770,00 1 099000010

**C99V0**

mala de ferramentas COMBO em ABS, com tampa transparente

As malas de ferramentas são facilmente encaixáveis entre si, através de um prático mecanismo de fecho lateral.

Caraterísticas principais:

- Tampa transparente em policarbonato resistente para identificação rápida do conteúdo
- Dimensões externas: 445x358x118 mm
- Capacidade máxima de carga interna: 25 kg
- Pode levar cadeado
- Peso: 2.5 kg

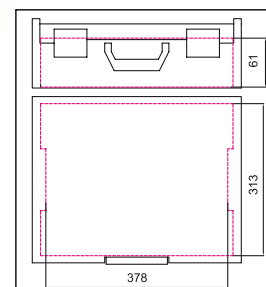

C99V0 € 123,00 1 099000202



## C99V0-P12

mala de ferramentas COMBO em ABS, com tampa transparente

As malas de ferramentas são facilmente encaixáveis entre si, através de um prático mecanismo de fecho lateral.

Características principais:

- Tampa transparente em policarbonato resistente para identificação rápida do conteúdo
- Particularmente adequada para transportar pequenos utensílios, incluindo parafusos, porcas, arruelas, rebites e buchas
- Fornecida com kit de 18 compartimentos:
  - 2 compartimentos vermelhos, 52x52 mm
  - 3 compartimentos amarelos, 104x52 mm
  - 2 compartimentos azuis, 104x104 mm
  - 1 compartimentos verdes, 104x156 mm
  - 2 compartimentos laranja, 208x52 mm
  - 2 compartimentos cinza, 312x71 mm, e 6 compartimentos ajustáveis
- Dimensões externas: 445x358x118 mm
- Capacidade máxima de carga interna: 25 kg
- Pode levar cadeado
- Peso: 3.2 kg

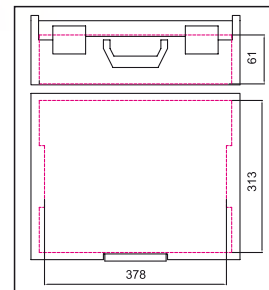

C99V0-P12

€ 174,00 1 099000200

## C99V2

Mala de ferramentas COMBO em ABS

As malas de ferramentas são facilmente encaixáveis entre si, através de um prático mecanismo de fecho lateral.

Principais características:

- Dimensões externas: 445x358x254 mm
- Capacidade máxima de carga interna: 25 kg
- Peso: 2.8 kg

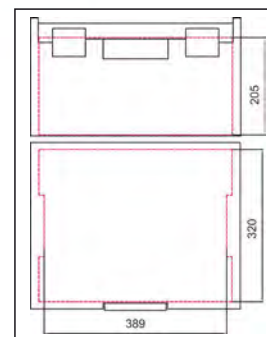

C99V2

€ 138,00 1 099000350

## C99V3/2C

Mala de ferramentas COMBO em ABS, com 2 tabuleiros portáteis

As malas de ferramentas são facilmente encaixáveis entre si, através de um prático mecanismo de fecho lateral.

Principais características:

- Dimensões externas: 445x358x322 mm
- Capacidade máxima de carga interna: 25 kg
- Fornecido com 2 tabuleiros C99C-V3 vazios
- Peso: 5.6 kg

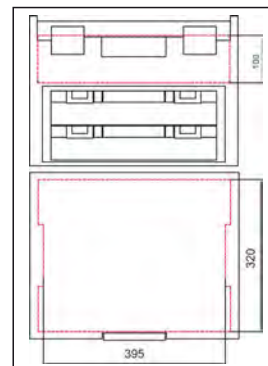

C99V3/2C

€ 265,00



099000450

## C99P

Carro de ferramentas tipo trolley rebatível

Principais características:

- Trolley de ferramentas rebatível ultracompacto
- Pega telescópica
- Dimensões aberto: 485x520x1095 mm
- Dimensões fechado: 485x80x810 mm
- Dimensões da base dobrável: 480x350 mm
- Duas rodas à prova de perfurações, Ø 175 mm
- Fornecido com alça
- Capacidade máxima: 100 kg
- Peso: 5.8 kg



C99P

€ 239,00



099000101

## C99PP

painel para malas de ferramentas COMBO



C99PP

€ 57,00



099000489



**RSC22**

bloco de ferramentas portátil com 3 gavetas

**Características principais:**

- 3 gavetas (588x277 mm)
- com guias de rolamentos de esfera:
- 1 gaveta, 50 mm altura
- 2 gavetas, 70 mm altura.
- Fechadura centralizada de segurança frontal.
- Punhos laterais retráteis para fácil movimentação.

19 kg



RSC22-O



RSC22-A



RSC22-R



h		
	50 mm	25 kg
	70 mm	25 kg

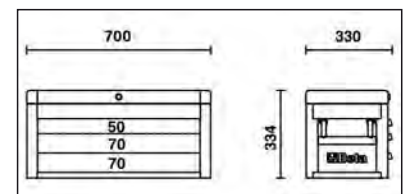
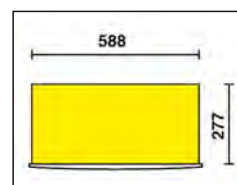

		€		
RSC22-O	RAL 2011	540,00	1	022003001
RSC22-R	RAL 3000	540,00	1	022003003
RSC22-A	RAL 7016	540,00	1	022003007



## RSC23

bloco de ferramentas portátil  
com 5 gavetas

### Características principais:

- 5 gavetas (588x277 mm)
- com guias de rolamentos de esfera:
- 2 gavetas, 50 mm altura
- 3 gavetas, 70 mm altura.
- Fechadura centralizada de segurança frontal.
- Punhos laterais retráteis para fácil movimentação.

📦 26 kg



RSC23-A



RSC23-R



RSC23-O



h	max
50 mm	25 kg
70 mm	25 kg

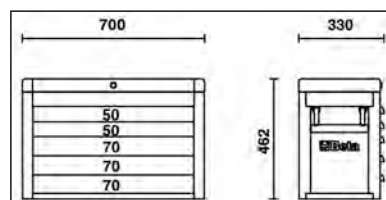
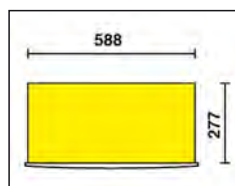

		€	📦	📄
RSC23-O	RAL 2011	685,00	1	023003001
RSC23-R	RAL 3000	685,00	1	023003003
RSC23-A	RAL 7016	685,00	1	023003007

## CD23S

trolley Caddy

### Características principais:

- Plano de trabalho em ABS compatível com os modelos C22S, C23S, C23SC, C23ST.
- A pega amovível pode ser guardada debaixo do chassis.
- 4 rodízios de Ø 125 mm:
- 2 fixos e 2 giratórios (um com travão).
- Carga máxima: 250 kg.

📦 14 kg



		€	📦	📄
CD23S		314,00	1	023000610

## RSC23C

bloco de ferramentas portátil  
com 8 gavetas

### Características principais:

- 8 gavetas (588x277 mm) com guias de rolamentos de esfera:
- 4 gavetas, 50 mm altura
- 3 gavetas, 70 mm altura
- 1 gaveta, 100 mm altura.
- Fechadura centralizada de segurança frontal.
- Punhos laterais retráteis para fácil movimentação.

📦 28 kg



RSC23C-A



RSC23C-R



RSC23C-O



h	max
50 mm	25 kg
70 mm	25 kg

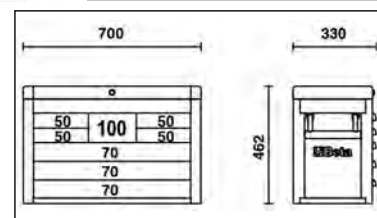
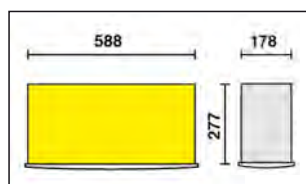

		€	📦	📄
RSC23C-O	RAL 2011	775,00	1	023003011
RSC23C-R	RAL 3000	775,00	1	023003013
RSC23C-A	RAL 7016	775,00	1	023003017

## RSC23T

bloco de ferramentas portátil  
com 5 gavetas

### Características principais:

- 5 gavetas (588x367 mm) com guias de rolamentos de esfera:
- 5 gavetas, 70 mm altura.
- Fechadura centralizada de segurança frontal.
- Pode ser equipado com 4 rodízios e 1 punho (2300ST/KIT)

📦 36 kg



RSC23T-A



RSC23T-B



RSC23T-G



RSC23T-N



RSC23T-R



RSC23T-O



RSC23T-FO

h	max
70 mm	25 kg

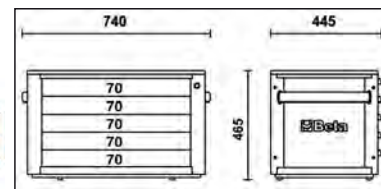
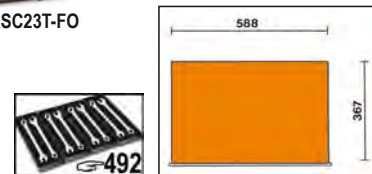

		€	📦	🚚
RSC23T-FO	RAL 2011	865,00	1	023003020
RSC23T-O	RAL 2011	865,00	1	023003021
RSC23T-G	RAL 9006	865,00	1	023003022
RSC23T-R	RAL 3000	865,00	1	023003023
RSC23T-B	RAL 5015	865,00	1	023003026
RSC23T-A	RAL 7016	865,00	1	023003027
RSC23T-N	RAL 9005	865,00	1	023003029

## 2300ST/KIT

kit de 4 rodízios e 1 punho para C23ST

- Quatro rodízios, Ø 125 mm:
- 2 fixos e 2 giratórios (um com travão).
- Punho telescópico

📦 6,5 kg

	€	📦	🚚
2300ST/KIT	232,00	1	023000950



# Beta







# CARRO DE FERRAMENTAS RSC24

# Beta RSC24

## NOVA SUPERFÍCIE DE TRABALHO MAIS FIRME E ROBUSTA MAIS CONVENIENTE E FUNCIONAL MAIS MODERNA

- Gavetas com guias de rolamentos de esferas
- Fundos das gavetas protegidos por tapetes em borracha
- Cada gaveta pode acomodar até 4 tabuleiros em esponja EVA ou ABS
- Nova superfície de trabalho em ABS reforçado, concebida para suportar os baús de ferramentas RSC22, RSC23, RSC23C e RSC23T
- Superfície de trabalho multiusos com arestas anti-queda e oito furos para chaves de fendas
- Fechadura frontal centralizada
- Quatro rodízios Ø 125 mm: 2 fixos e 2 giratórios (um com travão)
- Capacidade de carga estática: 800 kg



800 kg

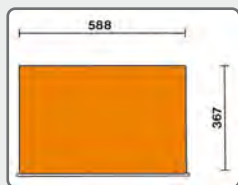
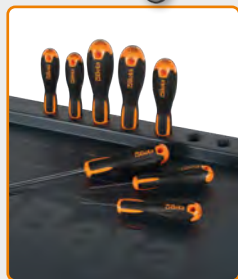

### Cores disponíveis:

FO	RAL 2011	RAL 2011
O	RAL 7016	RAL 2011
G	RAL 7016	RAL 9006
R	RAL 7016	RAL 3000
B	RAL 7016	RAL 5015
A	RAL 7016	RAL 7016
N	RAL 9005	RAL 9005

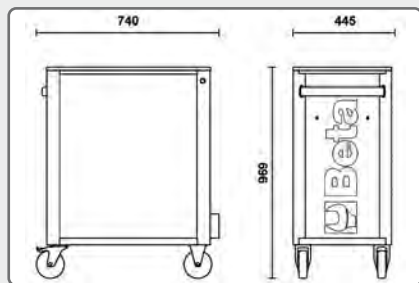

### Modelos disponíveis:

- RSC24/5 (5 gavetas)
- RSC24/6 (6 gavetas)
- RSC24/7 (7 gavetas)
- RSC24/8 (8 gavetas)



### Acessórios disponíveis:

2400 RSC24/PD-A  
2400 RSC24/PD-N



2400 RSC24/PL



2400 RSC24/SPC



2400 RSC24/PF-A  
2400 RSC24/PF-N



2400 RSC24/PF



2400 RSC24/AXLP/VL



2400 RSC24/MP



2400 RSC24/PC-A  
2400 RSC24/PC-N

## RSC24/7

carro de ferramentas com 7 gavetas

Características principais:

- 7 gavetas completamente amovíveis (588x367 mm), com guias de esferas:
- 5 gavetas, 70 mm altura
- 1 gaveta, 140 mm altura
- 1 gaveta, 210 mm altura

63 kg

	€		
RSC24/7-FO	1.200,00	1	024004070
RSC24/7-O	1.200,00	1	024004071
RSC24/7-G	1.200,00	1	024004072
RSC24/7-R	1.200,00	1	024004073
RSC24/7-B	1.200,00	1	024004076
RSC24/7-A	1.200,00	1	024004077
RSC24/7-N	1.200,00	1	024004079



RSC24/7-O

# Beta RSC24



RSC24/7-FO



RSC24/7-A



RSC24/7-B



RSC24/7-G



RSC24/7-N



RSC24/7-R



h	max
70 mm	25 kg
140 mm	30 kg
210 mm	30 kg



## RSC24/5

carro de ferramentas com 5 gavetas

Características principais:

- 5 gavetas completamente amovíveis (588x367 mm), com guias de esferas:
- 2 gavetas, 70 mm altura
- 2 gavetas, 140 mm altura
- 1 gaveta, 280 mm altura

60 kg

	€		
RSC24/5-FO	1.040,00	1	024004050
RSC24/5-O	1.040,00	1	024004051
RSC24/5-G	1.040,00	1	024004052
RSC24/5-R	1.040,00	1	024004053
RSC24/5-B	1.040,00	1	024004056
RSC24/5-A	1.040,00	1	024004057
RSC24/5-N	1.040,00	1	024004059



RSC24/5-O

Beta RSC24



h	max
70 mm	25 kg
140 mm	30 kg
280 mm	35 kg

## RSC24/6

carro de ferramentas com 6 gavetas

Características principais:

- 6 gavetas completamente amovíveis (588x367 mm), com guias de esferas:
- 4 gavetas, 70 mm altura
- 1 gavetas, 140 mm altura
- 1 gavetas, 280 mm altura

62 kg

	€		
RSC24/6-FO	1.120,00	1	024004060
RSC24/6-O	1.120,00	1	024004061
RSC24/6-G	1.120,00	1	024004062
RSC24/6-R	1.120,00	1	024004063
RSC24/6-B	1.120,00	1	024004066
RSC24/6-A	1.120,00	1	024004067
RSC24/6-N	1.120,00	1	024004069



RSC24/6-O

Beta RSC24



h	max
70 mm	25 kg
140 mm	30 kg
280 mm	35 kg

## RSC24/8

carro de ferramentas com 8 gavetas

Características principais:

- 8 gavetas completamente amovíveis (588x367 mm), com guias de esferas:
- 6 gavetas, 70 mm altura
- 2 gavetas, 140 mm altura

66 kg

	€		
RSC24/8-FO	1.300,00	1	024004080
RSC24/8-O	1.300,00	1	024004081
RSC24/8-G	1.300,00	1	024004082
RSC24/8-R	1.300,00	1	024004083
RSC24/8-B	1.300,00	1	024004086
RSC24/8-A	1.300,00	1	024004087
RSC24/8-N	1.300,00	1	024004089



RSC24/8-O

Beta RSC24



h	max
70 mm	25 kg
140 mm	30 kg

## RSC24A/6

carro com 6 gavetas,  
com sistema anti-inclinação

Características principais:

- 6 gavetas totalmente amovíveis (588x367 mm), com guias de rolamentos de esfera:
- 4 gavetas, 70 mm altura
- 1 gaveta, 140 mm altura
- 1 gaveta, 280 mm altura

62 kg

	€		
RSC24A/6-O	1.240,00	1	024004161
RSC24A/6-R	1.240,00	1	024004163
RSC24A/6-A	1.240,00	1	024004167



RSC24A/6-O

Beta RSC24



RSC24A/6-A



RSC24A/6-R



h	max
70 mm	25 kg
140 mm	30 kg
280 mm	35 kg

## RSC24A/7

carro com 7 gavetas,  
com sistema anti-inclinação

Características principais:

- 7 gavetas totalmente amovíveis (588x367 mm), com guias de rolamentos de esfera:
- 5 gavetas, 70 mm altura
- 1 gaveta, 140 mm altura
- 1 gaveta, 210 mm altura.

63 kg

	€		
RSC24A/7-O	1.330,00	1	024004171
RSC24A/7-R	1.330,00	1	024004173
RSC24A/7-A	1.330,00	1	024004177



RSC24A/7-O

Beta RSC24



RSC24A/7-A



RSC24A/7-R



h	max
70 mm	25 kg
140 mm	30 kg
210 mm	30 kg

## RSC24A/8

carro com 8 gavetas,  
com sistema anti-inclinação

Características principais:

- 8 gavetas totalmente amovíveis (588x367 mm), com guias de rolamentos de esfera:
- 6 gavetas, 70 mm altura
- 2 gavetas, 140 mm altura

66 kg

	€		
RSC24A/8-O	1.440,00	1	024004181
RSC24A/8-R	1.440,00	1	024004183
RSC24A/8-A	1.440,00	1	024004187



RSC24A/8-O

Beta RSC24



RSC24A/8-A



RSC24A/8-R



h	max
70 mm	25 kg
140 mm	30 kg



# CARRO DE FERRAMENTAS RSC24AXL

**Beta**  
RSC24

## VERSÃO LONGA:

cada gaveta pode acomodar até 6 tabuleiros em espuma EVA ou em ABS



### SISTEMA ANTI-QUEDA: IMPEDE QUE VÁRIAS GAVETAS SEJAM ABERTAS EM SIMULTÂNEO

- Gavetas com guias de rolamentos de esferas
- Superfície multiusos com sistema anti-inclinação, oito orifícios para chaves de fendas e 6 compartimentos para ferramentas.
- Frente robusta em nylon, com porta-etiquetas integrado
- Quatro rodízios Ø 125 mm: 2 fixos e 2 giratórios (um com travão)
- Capacidade de carga estática: 1000 kg
- Fundos das gavetas protegidos com tapetes em espuma de borracha
- Porta-garrafas lateral integrado
- Fechadura frontal centralizada

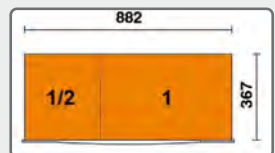
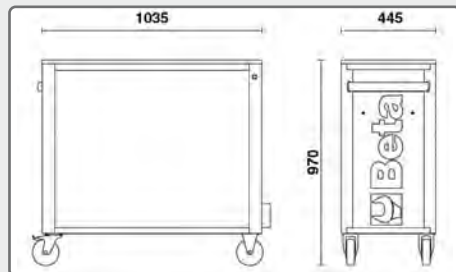

**Cores disponíveis:**

O	RAL 7016	RAL 2011
R	RAL 7016	RAL 3000
A	RAL 7016	RAL 7016

**Acessórios disponíveis:**



## RSC24AXL/7

carro com 7 gavetas, com sistema anti-inclinação, modelo longo

Características principais:

- 7 gavetas totalmente amovíveis (882x367 mm), com guias de rolamentos de esfera:

- 5 gavetas, 70 mm altura
- 1 gaveta, 140 mm altura
- 1 gaveta, 210 mm altura

1000 kg



**Beta**  
RSC24



h	max
70 mm	30 kg
140 mm	35 kg
210 mm	35 kg



84 kg

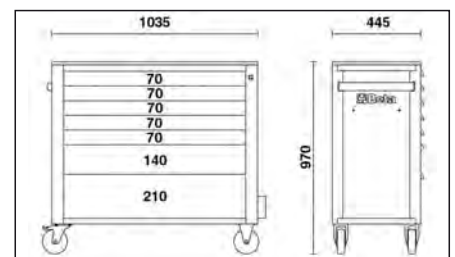

	€		
RSC24AXL/7-O	1.690,00	1	024004271
RSC24AXL/7-R	1.690,00	1	024004273
RSC24AXL/7-A	1.690,00	1	024004277



## RSC24AXL/8

carro com 8 gavetas,  
com sistema anti-inclinação,  
modelo longo

Características principais:

- 8 gavetas totalmente amovíveis (882x367 mm), com guias de rolamentos de esfera:

6 gavetas, 70 mm altura.

2 gavetas, 140 mm altura.

88 kg

	€		
RSC24AXL/8-O	1.810,00	1	024004281
RSC24AXL/8-R	1.810,00	1	024004283
RSC24AXL/8-A	1.810,00	1	024004287

1000  
kg



RSC24AXL/8-O

Beta RSC24



RSC24AXL/8-A



RSC24AXL/8-R

h	max
70 mm	30 kg
140 mm	35 kg

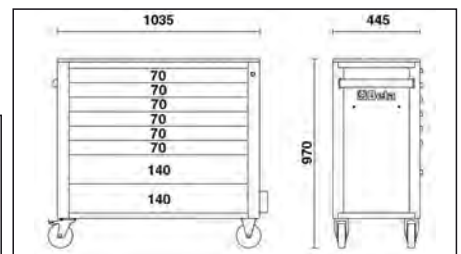

## RSC24AXL/9

carro com 9 gavetas,  
com sistema anti-inclinação,  
modelo longo

Características principais:

- 9 gavetas totalmente amovíveis (882x367 mm), com guias de rolamentos de esfera:

8 gavetas, 70 mm altura

1 gaveta, 140 mm altura.

90 kg

	€		
RSC24AXL/9-O	1.920,00	1	024004291
RSC24AXL/9-R	1.920,00	1	024004293
RSC24AXL/9-A	1.920,00	1	024004297

1000  
kg



RSC24AXL/9-O

Beta RSC24



RSC24AXL/9-A



RSC24AXL/9-R

h	max
70 mm	30 kg
140 mm	35 kg

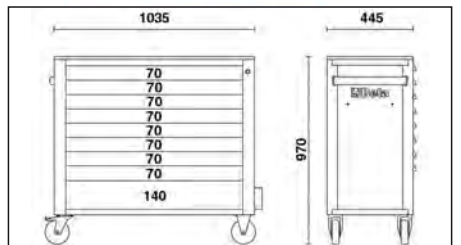
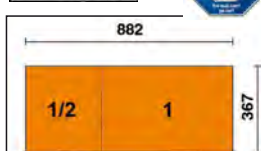

## RSC24AXLP/7

carro com 7 gavetas, com plano de trabalho em madeira e sistema anti-inclinação, modelo longo

### CARACTERÍSTICAS:

• 7 gavetas totalmente amovíveis (882x367 mm), com guias de rolamentos de esferas:

- 5 gavetas, 70 mm altura
- 1 gavetas, 140 mm altura
- 1 gavetas, 210 mm altura

- Plano de trabalho em madeira laminada com orifícios para torno 1599F/100 ou 1599GI/100 (a encomendar em separado)
- Parte frontal em nylon robusto, com porta-etiquetas
- Fundo das gavetas protegida com tapete de borracha
- 4 rodízios, Ø 125 mm: 2 fixos e 2 direcionáveis (um com travão)
- Fechadura frontal centralizada
- Capacidade de carga estática: 1.100 kg
- Porta-garrafas lateral integrado (possibilidade de montagem em ambos os lados)
- Porta-rolos de papel integrado
- Cada gaveta pode acomodar até 6 bandejas EVA ou ABS

1105 kg

1100 kg

Beta RSC24



RSC24AXLP/7-O

RSC24AXLP/7-A

RSC24AXLP/7-R

h	max
70 mm	30 kg
140 mm	35 kg
210 mm	35 kg

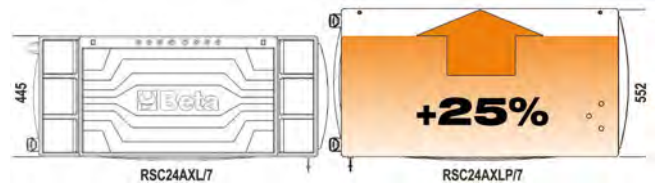

RSC24AXL/7

RSC24AXLP/7

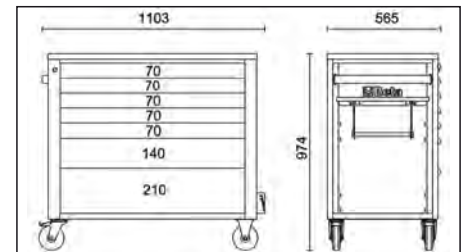

	€		
RSC24AXLP/7-O	1.940,00	1	024004571
RSC24AXLP/7-R	1.940,00	1	024004573
RSC24AXLP/7-A	1.940,00	1	024004577

## 2400 RSC24AXLP/PF

painel de ferramentas perfurado com suportes, para carro RSC24AXLP/7, RSC24L, RSC24L-CAB

Kit de 50 ganchos GPS incluído

4,5 kg



430  
2  
945

	€		
2400 RSC24AXLP/PF	137,00	1	024004992

Beta



## RSC24AXXL

carro com 8 gavetas e sistema anti-inclinação, modelo longo

Características principais:

- 1 gaveta totalmente amovível (1,176x367 mm), com guias de rolamentos de esferas
  - 7 gavetas totalmente amovíveis (882x367 mm), com guias de rolamentos de esferas:
- 6 gavetas 70 mm altura  
1 gaveta 140 mm altura

- Plano de trabalho em MDF revestido com aço inox, com orifícios para torno artigo 1599F/125 ou 1599GI/125 (opcional) e 6 tabuleiros para ferramentas
- Parte frontal em nylon resistente, com porta-etiquetas
- Fundo das gavetas protegido com tapete de borracha
- Compartimento lateral amovível, com guias de rolamentos de esferas, com prateleira e fechadura
- 4 rodízios, Ø 150 mm: 2 fixos e 2 direcionáveis com travão
- 3 fechaduras
- Porta-rolos de papel integrado
- Porta-garrafas integrado
- Capacidade de carga estática: 1,100 kg

- Possibilidade de adicionar os seguintes tabuleiros:  
até 8 tabuleiros maleáveis ou rígidos na gaveta 1,176x367 mm  
até 6 tabuleiros maleáveis ou rígidos na gaveta 882x367 mm

1100 kg

Beta RSC24



RSC24AXXL/O

h	max
70 mm (1.176x367 mm)	40 kg
70 mm (882x367 mm)	30 kg
140 mm (882x367 mm)	35 kg



RSC24AXXL/R



RSC24AXXL/A

131 kg

	€		
RSC24AXXL-O	2.400,00	1	024004781
RSC24AXXL-R	2.400,00	1	024004783
RSC24AXXL-A	2.400,00	1	024004787

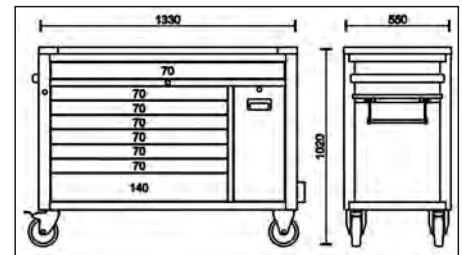
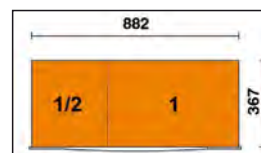
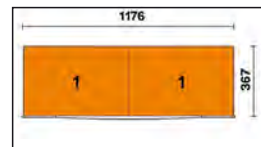

## 2400 RSC24AXXL/PF

painel de ferramentas perfurado com suportes, para carro de ferramentas RSC24AXXL

3,8 kg

	€		
2400 RSC24AXXL/PF	148,00	1	024004998



## 2400 RSC24AXLP/CPR

caixote de lixo para carro RSC24AXLP/7, RSC24AXXL

5 kg

	€		
2400 RSC24AXLP/CPR	75,00	1	024004993





## 2400 RSC24AXLP/VL

tabuleiro lateral de ferramentas para carro RSC24, RSC24A, RSC51, RSC24AXLP/7, RSC24AXXL

4 kg

2400 RSC24AXLP/VL	€ 57,50	1	024004995
-------------------	---------	---	-----------



## 2400 RSC24/PC

porta-rolos de papel para carro RSC24, RSC24A, RSC24AXL, RSC51

0,3 kg

2400 RSC24/PC-A	€ 28,50	1	024004903
2400 RSC24/PC-N	€ 28,50	1	024004904

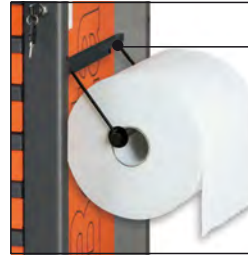

RAL7016  
2400 RSC24/PC-A  
RAL9005  
2400 RSC24/PC-N



## 2400 RSC24/PD

porta-documentos para carro RSC24, RSC24A, RSC24AXL

1,2 kg

2400 RSC24/PD-A	€ 49,50	1	024004907
2400 RSC24/PD-N	€ 49,50	1	024004908

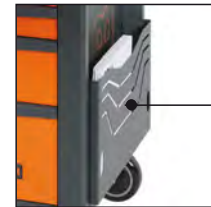

RAL7016  
2400 RSC24/PD-A  
RAL9005  
2400 RSC24/PD-N



## 2400 RSC24/PF

painel de ferramentas perfurado com suportes, para carro RSC24, RSC24A, RSC51

Kit de 50 ganchos GPS incluído

2,3 kg

2400 RSC24/PF	€ 109,00	1	024004902
---------------	----------	---	-----------

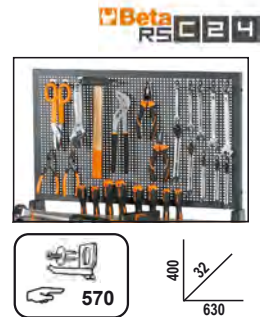

## 2400 RSC24/PF-

porta-garrafas para carro RSC24, RSC24A, RSC24AXL

0,5 kg

2400 RSC24/PF-A	€ 30,00	1	024004905
2400 RSC24/PF-N	€ 30,00	1	024004906

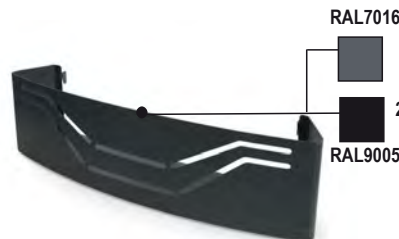

RAL7016  
2400S RSC24/PF-A  
RAL9005  
2400S RSC24/PF-N



## 2400 RSC24/PL

tabo de trabalho em madeira para carro RSC24, RSC24A, RSC24AXL, RSC51

4,3 kg

2400 RSC24/PL	€ 112,00	1	024004901
---------------	----------	---	-----------



## 2400 RSC24/SPC

suporte para computador para carro RSC24, RSC24A, RSC51, RSC24AXLP/7, RSC24AXXL

- Com gaveta amovível
- Não pode ser utilizado com o modelo RSC24AXL

3,1 kg

2400 RSC24/SPC € 162,00 1 024004909



## 2400 RSC24/MP

prateleira dobrável para artigos RSC24, RSC24A, RSC51, RSC24AXLP/7, RSC24AXXL

- Para utilização como superfície de trabalho adicional
- Dimensões superfície de trabalho: 390x440 mm, com tapete de borracha à prova de gasóleo e gasolina
- Capacidade de carga: 20 kg

3,4 kg

2400 RSC24/MP € 85,50 1 024004900



## 2499PF

prateleira porta-garrafas

- Podem ser instalados nos carros C38, C38A

2,5 kg

2499PF-O € 83,00 1 024990210  
2499PF-G € 83,00 1 024990219  
2499PF-R € 83,00 1 024990230

2499PF O

2499PF G

2499PF R



## 2499PF/M

suporte magnético universal para garrafas

2,2 kg

2499PF/M € 75,50 1 024990050



## 2499PC

porta-rolos de papel

- Compatível com os carros C25.

2,2 kg

2499PC € 88,50 1 024990090



## RSC24L/7

carro com 7 gavetas e prateleiras laterais

Características principais:

- 7 gavetas (588x367 mm) com guias de rolamentos de esfera:
- 5 gavetas, 70 mm altura
- 1 gaveta, 140 mm altura
- 1 gaveta, 210 mm altura.
- Fundo das gavetas protegido com tapete de borracha.
- 4 rodízios, Ø 125 mm:
- 2 fixos e 2 direcionáveis com travões.
- Fechadura centralizada de segurança frontal.
- Capacidade de carga estática: 1,100 kg.
- Plano de trabalho em madeira laminada com furos para fixação de um torno de bancada (1599F/100 - 1599GI/100, opcional).
- Compartimento lateral com prateleira ajustável em altura.
- Porta-rolos de papel integrado.
- Porta-garrafas duplo traseiro.
- Porta-garrafas lateral integrado

80 kg

		€		
RSC24L/7-O	RAL 2011	1.830,00	1	024004371
RSC24L/7-R	RAL 3000	1.830,00	1	024004373
RSC24L/7-A	RAL 7016	1.830,00	1	024004377

Beta RSC24

1100 kg



RSC24L/7-A



RSC24L/7-R



RSC24L/7-O

h	max
70 mm	25 kg
140 mm	30 kg
210 mm	30 kg

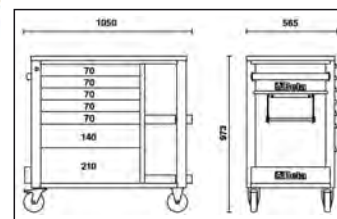
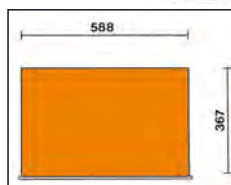

## RSC24L-CAB

carro com 7 gavetas e armário

Características principais:

- 7 gavetas (588x367 mm) com guias de rolamentos de esfera:
- 5 gavetas, 70 mm altura
- 1 gaveta, 140 mm altura
- 1 gaveta, 210 mm altura.
- Fundo das gavetas protegido com tapete de borracha.
- 4 rodízios, Ø 125 mm:
- 2 fixos e 2 direcionáveis com travão.
- Fechadura centralizada de segurança frontal.
- Armário lateral com porta com fechadura e prateleira ajustável em altura.
- Capacidade de carga estática: 1,100 kg.
- Plano de trabalho em madeira laminada com furos para fixação de um torno de bancada (1599F/100, opcional).
- Porta-rolos de papel integrado.
- Porta-garrafas duplo traseiro.
- Porta-garrafas lateral integrado

82 kg

		€		
RSC24L-CAB/O	RAL 2011	1.890,00	1	024004471
RSC24L-CAB/R	RAL 3000	1.890,00	1	024004473
RSC24L-CAB/A	RAL 7016	1.890,00	1	024004477

Beta RSC24

1100 kg



RSC24L-CAB/A



RSC24L-CAB/R



RSC24L-CAB/O

h	max
70 mm	25 kg
140 mm	30 kg
210 mm	30 kg

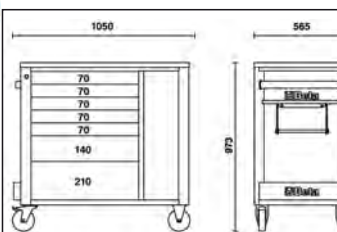
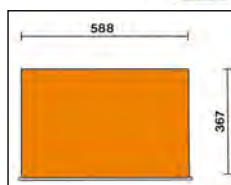



## C04TSS-7

carro com sete gavetas, totalmente em aço inoxidável, rodas anti-marcas



700 kg

Beta  
INOX  
STAINLESS STEEL

Principais características:

- Sete gavetas (570 x 410 mm) com calhas assentes em rolamentos de esferas;
- 6 gavetas, 83 mm altura;
- 1 gaveta, 170 mm altura;
- 4 rodízios Ø 125 mm
- 2 fixos e 2 giratórios (dois com travão);
- Fechadura frontal centralizada;
- Estrutura totalmente fabricada em aço inoxidável
- Roletes, suportes, esferas, interiores de gavetas e calhas em aço inoxidável
- Pegas das gavetas em alumínio

63 kg

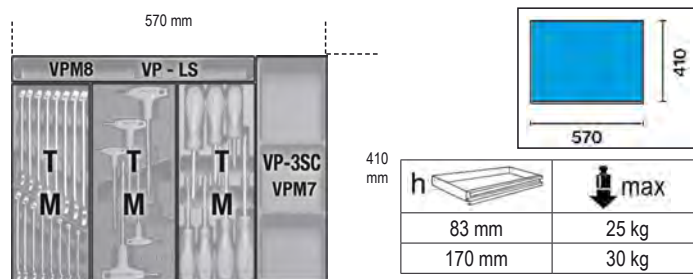

C04TSS/7

€ 2.870,00

1

024003077

296

## C25

carro Tank com prateleiras

Características principais:

- 1 tabuleiro deslizante.
- Tampo desdobrável com fecho.
- Plano de alojamento das ferramentas protegido com tapete de borracha.
- Prateleiras protegidas por tapetes de borracha à prova de óleos e combustíveis.
- 4 rodas com diâmetro de 100 mm:
- 2 rodas fixas e 2 rodas giratórias (uma com travão).
- Fechadura de segurança.
- Módulo vazio para chaves de caixa e acessórios de 1/2" para chaves de caixa e acessórios de 1/2" (024990104).
- Possibilidade de aplicar o suporte para rolos de papel 2499PC.

31,5 kg

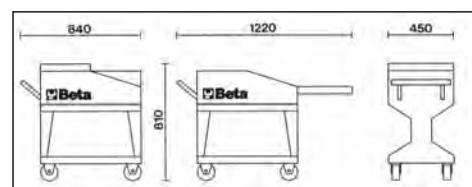

C25

€ 785,00

1

025000001

## C27S

carro de ferramentas tipo trolley rebatível para trabalhos ao ar livre

Carro de ferramentas tipo trolley, com colunas rebatíveis para transporte fácil. 2 gavetas, 588x277 mm, com guias de rolamentos de esferas para abertura nos dois sentidos.

Compartimento inferior de grandes dimensões, 588x277x220 mm.

Estrutura em metal.

2 rodízios fixos, Ø 160 mm, e 2 direccionáveis, Ø 100 mm (um com travão).

Plano de trabalho em termoplástico com 6 tabuleiros para ferramentas incluídos.

Fecho centralizado.

Pode ser equipado com divisórias para gavetas e tabuleiros soft

20 kg



C27S-O



C27S-G



C27S-R



h		max
	70 mm	20 kg

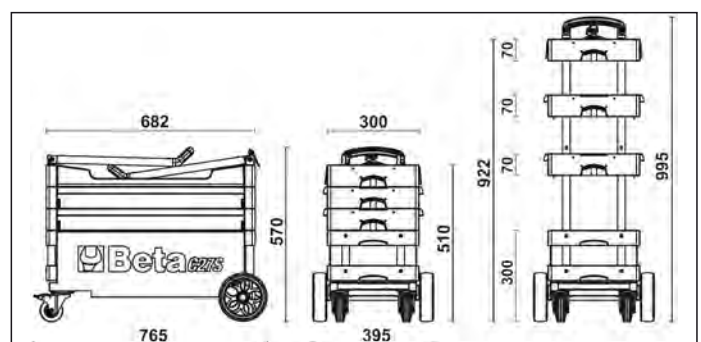
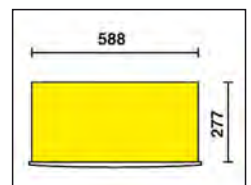

		€		
C27S-O	RAL 2011	880,00	1	027000201
C27S-G	RAL 7016	880,00	1	027000202
C27S-R	RAL 3000	880,00	1	027000203

## RSC28

trolley SuperTank com plano de trabalho em madeira e 10 gavetas

Características principais:

- 10 gavetas (588x367 mm) com guias de rolamentos de esfera.
- Sistema rápido e seguro para abertura e fecho das gavetas, frente em nylon com fibra de vidro.
- 5 gavetas laterais:
  - 4 gavetas, 70 mm altura
  - 1 gaveta, 210 mm altura.
- 5 gavetas frontais:
  - 4 gavetas, 70 mm altura
  - 1 gaveta, 210 mm altura.
- Fundo das gavetas protegido com tapete de borracha.
- 4 rodízios, Ø 150 mm:
  - 2 fixos e 2 direcionáveis com travões.
  - 2 fechaduras frontais centralizadas.
  - 3 gavetas frontais para ferramentas.
- Plano de trabalho em madeira laminada com furos para fixação de um torno de bancada (1599F/150 - 1599GI/150, opcional).
- Compartimento para ferramentas.
- Compartimento lateral com porta dobrável com fechadura.
- Porta-garrafas.
- Compartimento com 135 mm de altura com base revestida a plástico.
- Capacidade de carga estática: 1,200 kg.

  
**1200**  
**kg**



RSC28-O

 130 kg



RSC28-A



RSC28-R



h	max
70 mm	25 kg
210 mm	30 kg

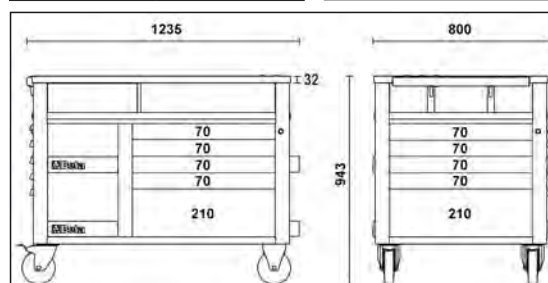
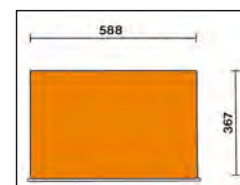

		€		
RSC28-O	RAL 2011	3.310,00	1	028003001
RSC28-R	RAL 3000	3.310,00	1	028003003
RSC28-A	RAL 7016	3.310,00	1	028003007



## C30M

bancada de trabalho móvel MaxiTank

Características principais:

- 5 gavetas frontais com guias de rolamentos de esfera: 3 gavetas (367x610 mm), 90 mm altura  
1 gaveta (588x610 mm), 90 mm altura  
1 gaveta (588x610 mm), 180 mm altura.
- Sistema de abertura rápida com frente em alumínio.
- Fundo das gavetas protegido com tapete de borracha.
- Pode ser equipado com bandejas flexíveis.
- Um macaco hidráulico, para elevar a parte frontal sem esforço, permitindo um transporte mais fácil.
- 4 rodízios: 2 direcionáveis à frente, Ø 150 mm  
2 fixos atrás, Ø 170 mm.
- Plano de trabalho revestido a borracha resistente ao óleo, 1300x800 mm, com orifício de drenagem para recolha de fluidos num pequeno reservatório.
- Compartimento de arrumação, 720x250x1300 mm, com plano de trabalho revestido a PVC e painéis frontais deslizantes.
- Fechaduras centralizadas para gavetas e painéis.
- 3 porta-garrafas laterais.
- Porta-rolos de papel
- Capacidade de carga estática: 1,800 kg.
- Pode ser equipado com plano de trabalho em madeira (3000M/PLM), opcional
- Pode ser equipado com torno 1599F/150 - 1599GI/150 (opcional).

1800 kg



200 kg



h	max
90 mm	30 kg
180 mm	35 kg

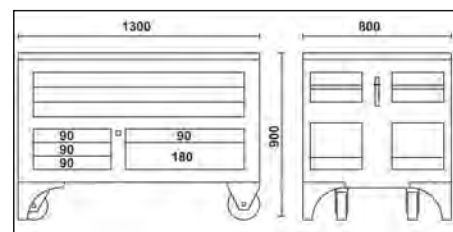
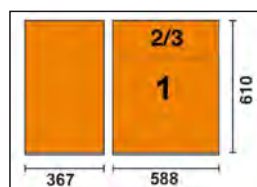

C30M

€ 5.300,00 1 030000300

## 3000M/PLM

plano de trabalho em madeira for C30M, com furos para fixação de um torno de bancada (1599F/150 - 1599GI/150)



1240x740x26 mm

10 kg

3000M/PLM

€ 515,00 1 030000350



# ARMÁRIO DE FERRAMENTAS INDUSTRIAL C35



## FUNCIONAL E ROBUSTO

- Gavetas amovíveis
- Fechadura frontal centralizada
- Possibilidade de montagem de superfície de trabalho e de divisões de gavetas (a encomendar separadamente)
- Capacidade de carga estática: 1200 kg

### Modelos disponíveis:

- C35/6GM (6 gavetas)
- C35/7GM (7 gavetas)
- C35/8GM (8 gavetas)
- C35/9GM (9 gavetas)

### Acessórios disponíveis:



## C35/6GM

armário de ferramentas industrial com 6 gavetas

### Características principais:

- 6 gavetas amovíveis (600x447 mm):
  - 2 gavetas 75 mm altura
  - 1 gaveta 100 mm altura
  - 1 gaveta 150 mm altura
  - 1 gaveta 200 mm altura
  - 1 gaveta 300 mm altura
- Fechadura frontal centralizada
- Possibilidade de montagem de superfície de trabalho e divisórias de gavetas, a encomendar separadamente

75 kg



h	max
75 mm	70 kg
100 mm	70 kg
150 mm	70 kg
200 mm	70 kg
300 mm	70 kg

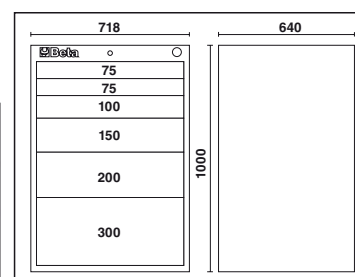
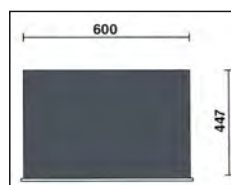

C35/6GM

€ 2.130,00 1 035000162

## C35/7GM

armário de ferramentas industrial com 7 gavetas

### Características principais:

- 7 gavetas amovíveis (600x447 mm):
  - 2 gavetas 75 mm altura
  - 1 gaveta 100 mm altura
  - 3 gavetas 150 mm altura
  - 1 gaveta 200 mm altura
- Fechadura frontal centralizada
- Possibilidade de montagem de superfície de trabalho e divisórias de gavetas, a encomendar separadamente

82 kg

C35/7GM

€ 2.220,00 1 035000172



h	max
75 mm	70 kg
100 mm	70 kg
150 mm	70 kg
200 mm	70 kg

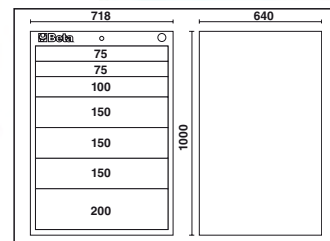
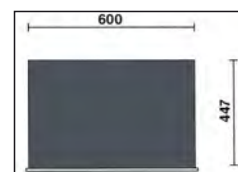

## C35/8GM

armário de ferramentas industrial com 8 gavetas

### Características principais:

- 8 gavetas amovíveis (600x447 mm):
  - 4 gavetas 75 mm altura
  - 1 gaveta 100 mm altura
  - 2 gavetas 150 mm altura
  - 1 gaveta 200 mm altura
- Fechadura frontal centralizada
- Possibilidade de montagem de superfície de trabalho e divisórias de gavetas, a encomendar separadamente

86 kg

C35/8GM

€ 2.370,00 1 035000182



h	max
75 mm	70 kg
100 mm	70 kg
150 mm	70 kg
200 mm	70 kg

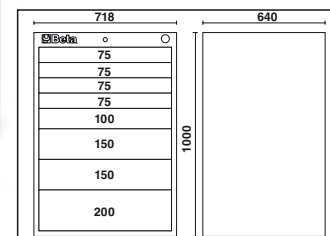

## C35/9GM

armário de ferramentas industrial com 9 gavetas

### Características principais:

- 8 gavetas amovíveis (600x447 mm):
  - 6 gavetas 75 mm altura
  - 3 gavetas 150 mm altura
- Fechadura frontal centralizada
- Possibilidade de montagem de superfície de trabalho e divisórias de gavetas, a encomendar separadamente

91 kg

C35/9GM

€ 2.480,00 1 035000192



h	max
75 mm	70 kg
150 mm	70 kg

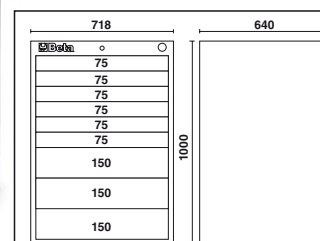
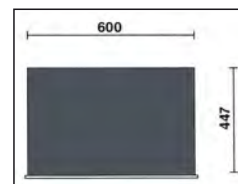

## 3500/P-M

superfície de trabalho com rebordo para armário de ferramentas C35

3500/P-M

700x600 mm

€ 414,00 1 035000505







# CARRO DE FERRAMENTAS C37

## PÁRA-CHOQUES

- Gavetas com guias de rolamentos de esferas
- Robusta superfície de trabalho multiusos
- Sistema de abertura rápida em alumínio, a todo o comprimento da gaveta
- Compartimentos e furos para chaves de fendas
- Quatro rodízios Ø 125 mm: 2 fixos e 2 giratórios (um com travão)
- Capacidade de carga estática: 1000 kg
- Pára-choques nos cantos a toda a altura do carro, para evitar danos aos veículos na garagem
- Fundos das gavetas protegidos com tapetes em espuma de borracha
- Fechadura frontal centralizada
- Porta-garrafas e porta-rolos de papel integrados, ajustáveis em várias posições

### Modelos disponíveis:

- C37/6 (6 gavetas)
- C37/7 (7 gavetas)
- C37/8 (8 gavetas)
- C37A/7 (7 gavetas com Sistema anti-queda)

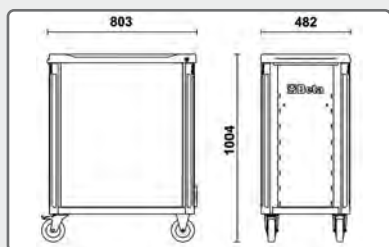
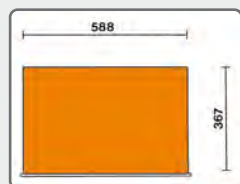

### Cores disponíveis:

O	RAL 2011
G	RAL 7016
R	RAL 3000



### Acessórios disponíveis:

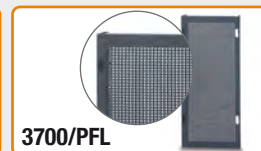

## C37/7

carro de ferramentas com 7 gavetas

Características principais:

- 7 gavetas (588x367 mm) com guias de rolamentos de esferas:
- 5 gavetas 75 mm altura
- 1 gaveta 150 mm altura
- 1 gaveta 225 mm altura

71 kg

1000 kg



C37/7-O



C37/7-G



C37/7-R



	€	1	037000071
C37/7-O	1.450,00	1	037000071
C37/7-G	1.450,00	1	037000072
C37/7-R	1.450,00	1	037000073

h	max
75 mm	30 kg
150 mm	35 kg
225 mm	35 kg

## C37/6

carro de ferramentas  
com 6 gavetas

Características principais:

- 6 gavetas (588x367 mm) com guias de rolamentos de esferas:
- 4 gavetas 75 mm altura
- 1 gaveta 150 mm altura
- 1 gaveta 305 mm altura

1000  
kg



h	max
75 mm	30 kg
150 mm	35 kg
305 mm	40 kg



69 kg

	€		
C37/6-O	1.400,00	1	037000061
C37/6-G	1.400,00	1	037000062
C37/6-R	1.400,00	1	037000063

## C37/8

carro de ferramentas  
com 8 gavetas

Características principais:

- 8 gavetas (588x367 mm) com guias de rolamentos de esferas:
- 6 gavetas 75 mm altura
- 2 gavetas 150 mm altura

1000  
kg



h	max
75 mm	30 kg
150 mm	35 kg



73 kg

	€		
C37/8-O	1.500,00	1	037000081
C37/8-G	1.500,00	1	037000082
C37/8-R	1.500,00	1	037000083

## C37A/7

carro com 7 gavetas,  
com sistema anti-inclinação

Características principais:

- 7 gavetas (588x367 mm), com guias de rolamentos de esferas:
- 5 gavetas 75 mm altura
- 1 gaveta 150 mm altura
- 1 gaveta 225 mm altura

1000  
kg



h	max
75 mm	30 kg
150 mm	35 kg
225 mm	35 kg



71 kg

	€		
C37A/7-O	1.490,00	1	037000271
C37A/7-G	1.490,00	1	037000272
C37A/7-R	1.490,00	1	037000273



### 3700/PLA

plano de trabalho em aço inox para carro de ferramentas item C37, C37A

2,8 kg

3700/PLA € 84,00 1 037000100



672x396x1,5 mm

### 3700/PLL

superfície de trabalho em madeira para carro C37, C37A

Possibilita montagem de torno (1599P/100, a encomendar separadamente)

3,9 kg

3700/PLL € 106,00 1 037000101



672x396x28 mm

### 3700/PF

painel perfurado com suportes para carro de ferramentas item C37, C37A

Kit de 50 ganchos GPS incluído

3,2 kg

3700/PF € 153,00 1 037000102

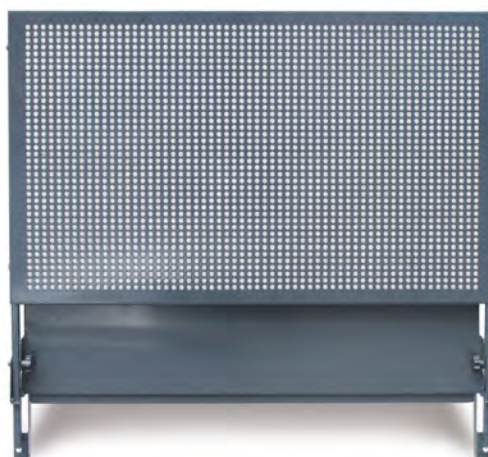

626  
650

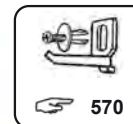

### 3700/PFL

painel lateral perfurado para carro de ferramentas item C37, C37A

1,9 kg

3700/PFL € 44,50 1 037000104



754  
321



### 3700/PC

suporte para computador para carro de ferramentas item C37, C37A

3,1 kg

3700/PC € 114,00 1 037000103

303  
418





# CARRO DE FERRAMENTAS C39

## LATERAIS E PARTE FRONTAL DAS GAVETAS EM LIGA DE ALUMÍNIO

+ **ROBUSTEZ**

+ **LEVEZA**

- Gavetas com guias de rolamentos de esferas
- Superfície de trabalho termoplástica, concebida para suportar o baú de ferramentas portátil C39T
- Sistema de abertura rápida em alumínio, a todo o comprimento da gaveta
- Quatro rodízios Ø 125 mm: 2 fixos e 2 giratórios (um com travão)
- Capacidade de carga estática: 1200 kg
- Fundos das gavetas protegidos com tapetes em espuma de borracha
- Fechadura frontal centralizada
- Compartimentos e furos para chaves de fendas
- Porta-garrafas lateral e traseiro integrados
- Porta-rolos de papel integrado

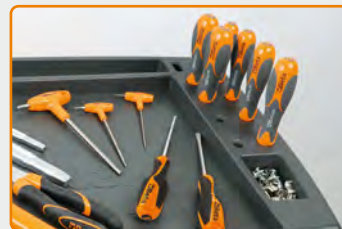

**Cores disponíveis:**

### Modelos disponíveis:

- C39/6 (6 gavetas)
- C39/7 (7 gavetas)
- C39/8 (8 gavetas)

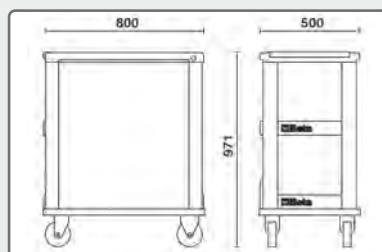
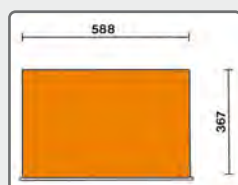

O	RAL 2011
G	RAL 7016
R	RAL 3000

## C39/7

carro com sete gavetas

Características principais:

- 7 gavetas (588x367 mm) montadas em guias telescópicas de esfera:
- 5 gavetas, 70 mm altura.
- 1 gaveta, 140 mm altura.
- 1 gaveta, 210 mm altura.

61 kg

1200 kg



C39-7/G



C39-7/R

C39-7/O

h	max
70 mm	30 kg
140 mm	35 kg
210 mm	35 kg



	€		
C39-7/O	2.180,00	1	039000001
C39-7/G	2.180,00	1	039000002
C39-7/R	2.180,00	1	039000003

## C39/6

carro com 6 gavetas

Características principais:

- 6 gavetas (588x367 mm) com guias de rolamentos de esferas:

4 gavetas, 70 mm altura

1 gaveta, 140 mm altura

1 gaveta, 280 mm altura

1200 kg



C39-6/O



C39-6/G



C39-6/R



h	max
70 mm	30 kg
140 mm	35 kg
280 mm	40 kg



59 kg

	€		
C39-6/O	2.070,00	1	039000031
C39-6/G	2.070,00	1	039000032
C39-6/R	2.070,00	1	039000033

## C39/8

carro com 8 gavetas

Características principais:

- 8 gavetas (588x367 mm) com guias de rolamentos de esferas:

6 gavetas, 70 mm altura

2 gavetas, 140 mm altura

1200 kg



C39-8/O



C39-8/G



C39-8/R



h	max
70 mm	30 kg
140 mm	35 kg



64 kg

	€		
C39-8/O	2.330,00	1	039000041
C39-8/G	2.330,00	1	039000042
C39-8/R	2.330,00	1	039000043

## C39T

baú portátil para ferramenta com quatro gavetas

Características principais:

- 4 gavetas (588x367 mm) em guias de rolamentos de esferas:

4 gavetas, 70 mm altura

• Fecho centralizado frontal de segurança.

• Gaveta e perfis laterais em alumínio



C39T-O



C39T-R



C39T-G



29 kg

h	max
70 mm	30 kg

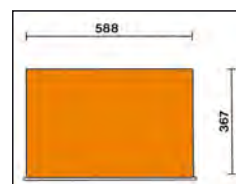
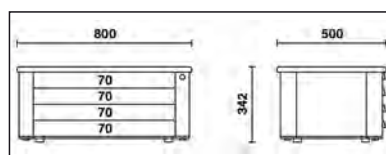

	€		
C39T-O	1.400,00	1	039000101
C39T-G	1.400,00	1	039000102
C39T-R	1.400,00	1	039000103

## 2400-COVER RSC24

capa de nylon para carros de ferramentas RSC24/A - C39



2400-COVER RSC24

€ 28,50 1 024000910

## 2400-COVER RSC24AXL

capa de nylon para carros de ferramentas RSC24A-XL, RSC24L, RSC24L-CAB



2400-COVER RSC24AXL

€ 38,50 1 024000930

# Beta



## C39SM

carro de ferramentas especial, tipo SM

### Especificações

- Tampo em madeira prensada
- 4 rodas, Ø 125 mm
- 2 fixas e 2 giratórias (uma com travão), com protecção
- Capacidade de carga estática: 1200 kg

### módulo 7 gavetas

- 588x367 mm, com calha de rolamentos de esferas:
- 6 gavetas, 70 mm altura
- 1 gavetas, 240 mm altura
- Base das gavetas protegida com tapete em borracha
- Fecho frontal centralizado
- Sistema de abertura ao comprimento total da gaveta
- Painel frontal da gaveta em alumínio

### Módulo de serviço

- Caixa de lixo integrado
- Compartimento para rolo de papel
- 1 gaveta grande (420x305x270 mm)

1200 kg



C39SM-G



C39SM-R



C39SM-O



h	max
70 mm	30 kg
240 mm	40 kg

125 kg

		€		
C39SM-O	RAL 2011	3.540,00	1	039390001
C39SM-G	RAL 7016	3.540,00	1	039390002
C39SM-R	RAL 3000	3.540,00	1	039390003

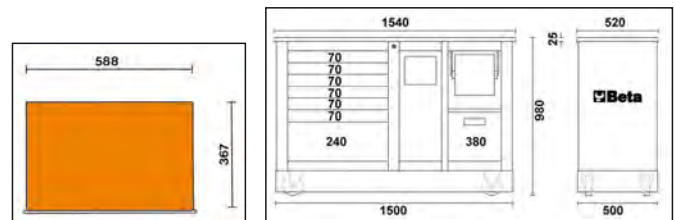

## C39MD

carro de ferramentas especial, tipo MD

### Especificações

- Tampo em madeira prensada
- 4 rodas, Ø 125 mm
- 2 fixas e 2 giratórias (1 com travão), com protecção
- Capacidade de carga estática: 1200 kg

### módulo 7 gavetas

- 588x367 mm, com calhas assentes em rolamentos de esferas:
- 6 gavetas, 70 mm altura
- 1 gaveta, 240 mm altura
- Base das gavetas protegida com tapete em borracha
- Fecho frontal centralizado
- Sistema de abertura ao comprimento total da gaveta
- Painel frontal da gaveta em alumínio

### módulo 2 gavetas

- 588x367x270 mm e 588x367x380 mm, com calhas assentes em rolamentos de esferas
- Base das gavetas protegida com tapete em borracha
- Fecho frontal centralizado
- Sistema de abertura ao comprimento total da gaveta
- Painel frontal da gaveta em alumínio

1200 kg



C39MD-G



C39MD-R



C39MD-O



h	max
70 mm	30 kg
240 mm	40 kg

123 kg

		€		
C39MD-O	RAL 2011	3.650,00	1	039390101
C39MD-G	RAL 7016	3.650,00	1	039390102
C39MD-R	RAL 3000	3.650,00	1	039390103

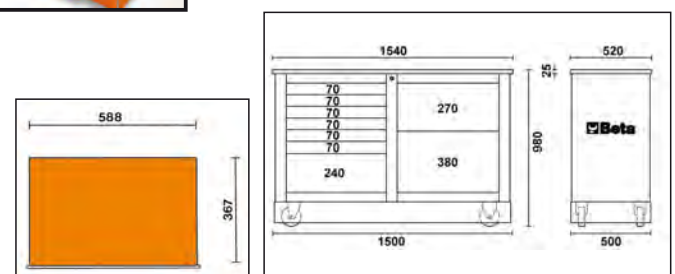

## C41S

malas de ferramentas tipo trolley com dois módulos

Características principais:

- estrutura em metal e topos em plástico que garantem uma alta robustez e peso reduzido.
- 2 módulos separados:
  - 1 caixa de ferramentas,
  - 1 módulo com duas gavetas de 95 mm e 295 mm de altura respectivamente.
- Rodas com grande diâmetro (160 mm), para um transporte facilitado - por exemplo, em escadas.
- Fechadura lateral centralizada para fechar as gavetas do módulo de baixo.
- Gavetas montadas em guias telescópicas e com fechadura de ganchos duplos.
- Punho telescópico em alumínio
- Porta utensílios na caixa superior
- Gaveta inferior com extensão de duplo rolamento de esferas

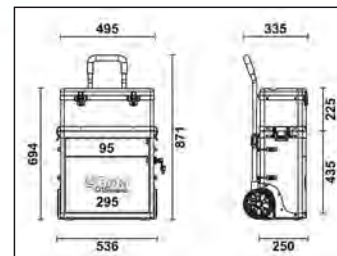
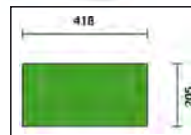

16 kg

C41S

€ 600,00 1 041000001

## C41H

malas de ferramentas tipo trolley com dois módulos

Características principais:

- estrutura em metal e topos em plástico que garantem uma alta robustez e peso reduzido.
- 2 módulos removíveis:
  - 1 caixa de ferramentas,
  - 1 módulo com duas gavetas 95 mm de altura,
  - 1 uma caixa removível de plástico, 66 mm altura, e 1 gaveta de 295 mm de altura.
- Rodas com grande diâmetro (160 mm), para um transporte facilitado - por exemplo, em escadas.
- Fechadura lateral centralizada para fechar as gavetas do módulo de baixo
- Gavetas montadas em guias telescópicas e com fechadura de ganchos duplos.
- Punho telescópico em alumínio
- Porta utensílios na caixa superior
- Gaveta inferior com extensão de duplo rolamento de esferas



C41H-O



C41H-W

C41H-Y

C41H-R

C41H-V

C41H-B

C41H-G

C41H-N

21 kg

		€		
C41H-O	RAL 2011	680,00	1	041000002
C41H-N	RAL 9005	680,00	1	041000005
C41H-B	RAL 5002	680,00	1	041000006
C41H-R	RAL 3000	680,00	1	041000008
C41H-G	RAL 7016	680,00	1	041000010
C41H-Y	RAL 1023	680,00	1	041000012
C41H-W	RAL 9016	680,00	1	041000021
C41H-V	RAL 6016	680,00	1	041000024

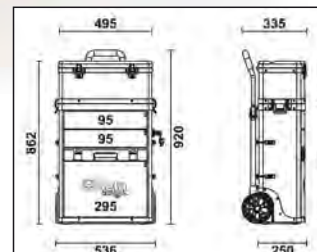
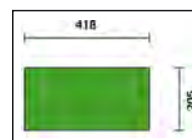

## C41H/CE

caixa para ferramentas, com compartimentos para pequenas ferramentas removíveis, em material plástico

1,3 kg

C41H/CE

€ 42,50 1 041000916



## C42H

Mala de ferramentas tipo trolley com três módulos

### Características principais:

- Estrutura em metal e topos em plástico que garantem uma alta robustez e peso reduzido.
- 3 módulos removíveis:
  - 1 caixa de ferramentas superior, 220 mm altura
  - 1 módulo central, 180 mm altura,
  - 1 módulo inferior com rodas, 20 mm altura.
- Rodas de grande diâmetro (ø160 mm).
- Punho telescópico, ajustável em 3 posições.
- Sistema de desengate rápido dos módulos: acesso fácil e rápido a todos os compartimentos.
- Caixa de ferramentas superior com compartimento interno para ferramentas e 3 tabuleiros integrados na tampa.
- Pode ser utilizada apenas com 2 módulos.

14 kg

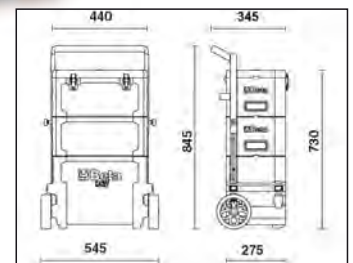

C42H

€ 482,00 1 042000002





## CX49-G

trolley multiusos

pode ser usado como estação de trabalho móvel para ferramentas de diagnóstico, laptops, dispositivos de teste e carregadores de bateria.

- Estrutura em chapa pintada: firmeza e robustez incomparáveis
- Punho ergonómico
- Tampo 2 níveis
- Prateleira deslizante para teclado
- 2 prateleiras centrais com posição ajustável e 1 inferior fixa
- 4 práticos enroladores laterais em plástico
- 2 úteis compartimentos laterais
- 2 rodízios traseiros fixos Ø 160 mm
- 2 rodízios frontais giratórios Ø 100 mm (1 com travão)
- Peso: 36 kg

CX49-G

€ 895,00 1 049000102

1099 mm  
460 mm  
435 mm



## CA49-G

Trolley multiusos com porta

Pode ser usado como estação de trabalho móvel para ferramentas de diagnóstico, laptops, dispositivos de teste e carregadores de bateria.

Características

- Estrutura em chapa pintada: firmeza e robustez incomparáveis
- Punho ergonómico
- Tampo 2 níveis
- Prateleira deslizante para teclado
- 1 prateleiras centrais com posição ajustável e 1 inferior fixa
- 4 práticos enroladores laterais em plástico
- 2 úteis compartimentos laterais
- 2 rodízios traseiros fixos Ø 160 mm
- 2 rodízios frontais giratórios Ø 100 mm (1 com travão)
- Peso: 36,5 kg

CA49-G

€ 1.010,00 1 049000112



1099 mm  
460 mm  
435 mm

## 4900-COVER C49

Capa em nylon, para trolley multiusos C49

4900-COVER C49

€ 42,50 1 049000930



As dimensões compactas e a versatilidade de utilização fazem da plataforma C48M a solução ideal para o manuseamento de cargas pesadas (caixas, bidons, objetos volumosos, peças de equipamentos) em total segurança, inclusive em áreas de difícil acesso e em ambientes de trabalho que não permitem o acesso através de empilhadores convencionais.

Isso resulta em riscos significativamente reduzidos para os operadores - por exemplo, distúrbios músculo-esqueléticos causados pela movimentação manual de cargas.

Plataforma motorizada, com motor 24V - 400W com alimentação a bateria 2x12V 33Ah e placa de controlo Curtis.

Piso de carga em aço resistente, revestido com borracha antiderrapante, com painéis tubulares redondos que impedem a queda de objetos durante o transporte.

Os painéis podem ser removidos para atender às necessidades individuais de transporte.

A consola de controlo está equipada com:

- chave de ignição
- botão de ajuste de velocidade
- punhos laterais para controlo de tração
- sinal sonoro intermitente, ativado ao fazer marcha-atrás
- indicador de carga da bateria
- botão de corte do travão elétrico
- botão de emergência.

Equipada com 2 rodas de tração pneumática (Ø 260 mm) e 2 rodas giratórias de borracha (Ø 150 mm), travão eletromagnético e caixa de diferencial. Fornecido com carregador de bateria externo, 220V/50Hz - V/A 24/12

#### ESPECIFICAÇÕES FUNCIONAIS

Capacidade de carga: 400 kg

Velocidade de condução: 4-6 km/h (ajustável)

Duração da bateria: 4 horas

Inclinação máxima permitida com carga total: 6%

Inclinação máxima permitida com carga de 100 kg: 18%

Travão eletrónico

Buzina

Proteção anti-esmagamento

Indicador de carga da bateria

Sistema de controlo Curtis

#### ESPECIFICAÇÕES TÉCNICAS

Dimensões gerais: 1280x630x1100h mm

Dimensões úteis da plataforma de carga com painéis: 1180x580 mm

Dimensões úteis da plataforma de carga sem painéis: 1260x620 mm

Altura da plataforma de carga em relação ao chão: 320 mm

Altura do compartimento da bateria em relação ao chão: 65 mm

Peso com baterias: 140 kg

**Beta**  
**BRUTUS**

400  
kg

CE



1100  
630  
1280



140 kg

## C48P

carro de ferramentas dobrável

### Características:

- Plataforma de carga em polipropileno reforçado (PP), com revestimento antiderrapante e inserções TPV para proteção dos cantos
- Pega retrátil para arrumação fácil e rápida
- Quatro rodízios antimarcas, Ø 125 mm: 2 fixos e 2 giratórios com travões
- Capacidade máxima: 300 kg
- Largura útil da plataforma de carga: 705 mm
- Profundidade plataforma de carga: 480 mm
- Altura plataforma de carga: 200 mm



11 kg

C48P € 307,00 1 048000030

## C51

carro

- 3 planos cobertos com borracha estriada anti-deslizante
- Punho de transporte ergonómico
- Duas opções de fixação de posto de trabalho superior
- Quatro rodas Ø 100 mm: 2 fixas e 2 giratórias (1 com travão)
- Capacidade de carga, parado: 200 kg (distribuídos pelas 3 prateleiras)

21 kg

		€		
C51 O	RAL 2011	342,00	1	051000001
C51 G	RAL 7016	342,00	1	051000002
C51 R	RAL 3000	342,00	1	051000003

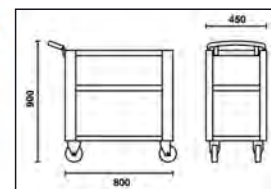
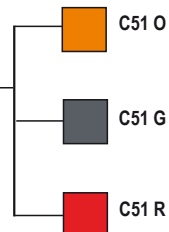

# Beta

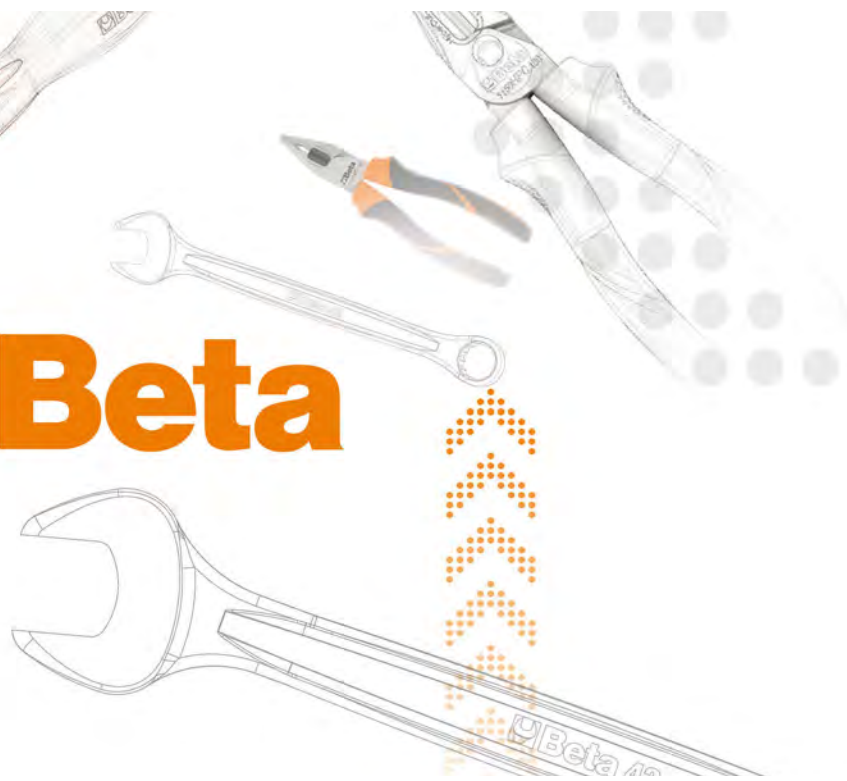
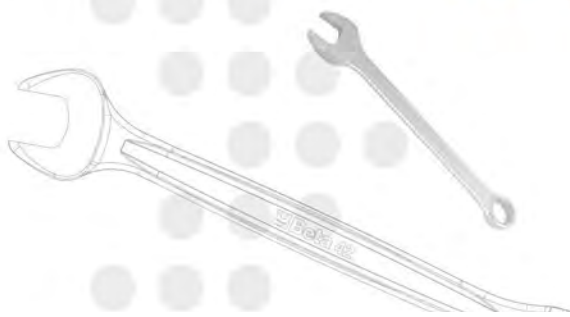



## RSC51

carro com 3 gavetas

Principais características:

- Superfície de trabalho em ABS reforçado, sólida e robusta
- Tampo multiusos com arestas anti-queda e 8 furos para chaves de fendas
- 3 gavetas (588x367 mm) com guias de rolamentos de esferas, 70 mm altura
- Bases das gavetas protegidas por tapetes em borracha
- Cada gaveta pode acomodar até 4 tabuleiros maleáveis em EVA ou ABS
- Fechadura de segurança frontal centralizada
- Conveniente apoio lateral para chave de fendas integrado
- Dois suportes laterais integrados para latas de spray
- Grande prateleira inferior protegida por tapete à prova de petróleo/gasolina
- 4 rodízios, Ø 125 mm: 2 fixos e 2 giratórios (um com travão)

- Capacidade de carga estática: 400 kg
- Capacidade de cada gaveta: 15 kg, distribuídos de forma equilibrada



RSC51-R



RSC51-A

RSC51-FO

38 kg

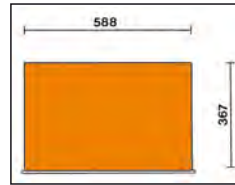

h	max
70 mm	15 kg

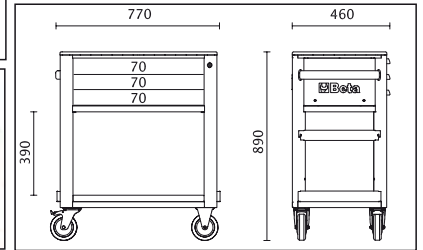

		€		
RSC51-FO	RAL 2011 - 7016	685,00	1	051000300
RSC51-R	RAL 3000 - 7016	685,00	1	051000303
RSC51-A	RAL 7016	685,00	1	051000307

## 2400 RSC24/MP

prateleira dobrável para artigos RSC24, RSC24A, RSC51, RSC24AXLP/7, RSC24AXXL

- Para utilização como superfície de trabalho adicional
- Dimensões superfície de trabalho: 390x440 mm, com tapete de borracha à prova de gásóleo e gasolina
- Capacidade de carga: 20 kg

3,4 kg

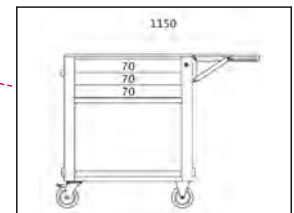

		€		
2400 RSC24/MP		85,50	1	024004900



## CP51

mala de ferramentas tipo trolley robusta

- 2 planos cobertos com borracha estriada anti-deslizante
- Punho de transporte ergonómico
- 4 rodas Ø 125 mm:  
2 fixas e 2 giratórias com travão
- Capacidade de carga: 750 kg (distribuído pelas 2 praticados)

37 kg

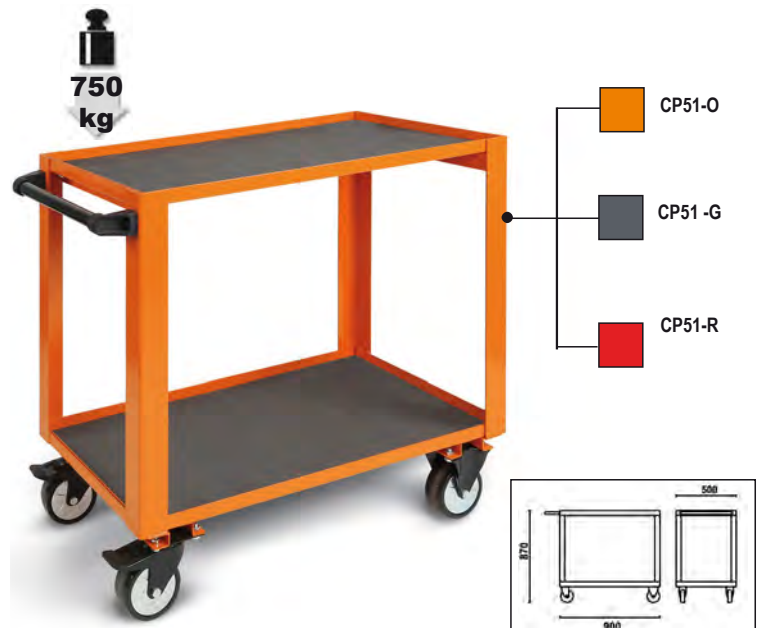

		€		
CP51 O	RAL 2011	452,00	1	051000501
CP51 G	RAL 7016	452,00	1	051000502
CP51 R	RAL 3000	452,00	1	051000503

## CB52

bancada com rodas para caixas de velocidades/transmissões com sistema de recuperação de líquidos  
Inclinação e furos de drenagem para recuperação de líquidos em depósito coletor

Equipada com:

- 4 rodízios giratórios, 2 com travões
- gaveta para ferramentas
- depósito coletor de líquido; capacidade: 7 l
- 2 prateleiras

Dimensões: 1200x640x870 mm  
Peso: 60 kg

60 kg



CB52-O		€		
		865,00	1	052000201

## C56P O

bancada de trabalho dobrável

Compacta e fácil de transportar.

Tampo 800x500mm, em MDF e chapa de ferro galvanizada com 30 mm espessura; possibilidade de utilização em ambos os lados.

Pega com revestimento em borracha para fácil transporte.

Pés anti-derrapantes.

Capacidade estática de carga: 250 kg

25 kg

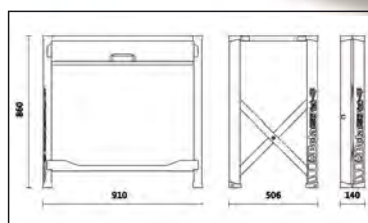

C56P O

€ 476,00 1 056000011

## C56PL O

Bancada de trabalho rebatível, versão leve

Leve, compacta, fácil de transportar.

Tampo (800x500mm) em chapa de ferro galvanizado, protegida por cobertura de borracha resistente ao óleo e combustíveis (para utilização apenas de 1 lado)

Pega com revestimento em borracha para fácil transporte.

Pés anti-derrapantes.

Capacidade estática de carga: 200 kg

18,5 kg

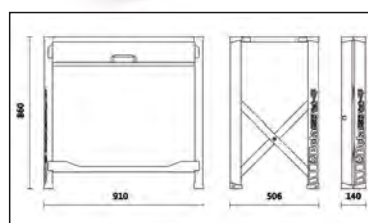

C56PL O

€ 411,00 1 056000021



## C54S

armários Cargo

Concebidos a partir de diversos inquéritos efectuados a utilizadores profissionais, oferecem algumas das soluções para operar de um modo confortável e racional. Painéis perfurados apoiados sobre dobradiças no interior das portas para que seja possível usufruir do espaço proporcionado pela superfície interior.

### Características principais:

- 1 gaveta montada sobre guias telescópicas.
- Grande facilidade em efectuar alterações estruturais para encontrar a melhor solução para cada caso específico.
- Fixação á parede através de duas cavidades existentes no painel posterior ou como solução móvel possibilidade de fixação através de dois parafusos a um carro Team C50.
- Fechadura simultânea de segurança para portas e gavetas.
- Módulos de gavetas vazios com inserts para chaves de caixa e acessórios de 1/2".



37 kg

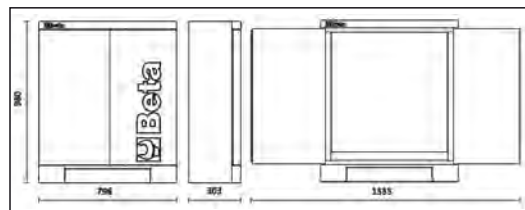

C54S-O

€ 865,00 1 054000301



Beta



## C57SA

bancada de trabalho MasterCargo

- Modelo com armário (C57P) e um bloco de gavetas.

Bloco de gavetas composto por 5 gavetas, 588x367 mm, 3 de 90 mm altura, 1 de 180 mm altura e 1 de 280 mm altura, com guias de rolamentos de esferas. Pode ser equipada com tabuleiros. Fecho centralizado.

Painel para ferramentas, com orifícios para fixação à parede. Persiana em alumínio com fechadura de segurança. Três painéis perfurados amovíveis para ferramentas.

Plano de trabalho em madeira laminada plastificada, com três orifícios para torno ref. 1599F/150 - 1599GI/150, extra opcional.



C57S/A-O

205 kg



C57S/A-G

C57S/A-R



h	max
90 mm	30 kg
180 mm	40 kg
280 mm	40 kg

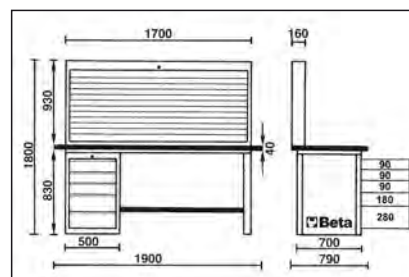

		€		
C57S/A-O	RAL 2011	5.450,00	1	057001005
C57S/A-G	RAL 7016	5.450,00	1	057001205
C57S/A-R	RAL 3000	5.450,00	1	057001405

## C57SD

bancada de trabalho MasterCargo

- Modelo com um bloco de gavetas.

Bloco de gavetas composto por 5 gavetas, 588x367 mm, 3 de 90 mm altura, 1 de 180 mm altura e 1 de 280 mm altura, com guias de rolamentos de esferas. Pode ser equipada com tabuleiros. Fecho centralizado.

Plano de trabalho em madeira laminada, plastificada, com três orifícios para torno ref. 1599F/150 - 1599GI/150, extra opcional.



C57S/D-O

158 kg

h	max
90 mm	30 kg
180 mm	40 kg
280 mm	40 kg

		€		
C57S/D-O	RAL 2011	3.830,00	1	057001004
C57S/D-G	RAL 7016	3.830,00	1	057001204
C57S/D-R	RAL 3000	3.830,00	1	057001404

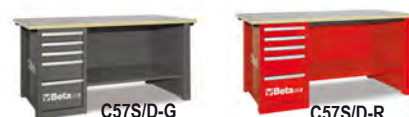

C57S/D-G

C57S/D-R

## C57SB

bancada de trabalho MasterCargo

- Modelo com armário (C57P) e dois blocos de gavetas.

Bloco de gavetas composto por 5 gavetas, 588x367 mm, 3 de 90 mm altura, 1 de 180 mm altura e 1 de 280 mm altura, com guias de rolamentos de esferas. Pode ser equipada com tabuleiros. Fecho centralizado.

Painel para ferramentas, com orifícios para fixação à parede. Persiana em alumínio com fechadura de segurança. Três painéis perfurados amovíveis para ferramentas.

Plano de trabalho em madeira laminada plastificada, com três orifícios para torno ref. 1599F/150 - 1599GI/150, extra opcional.



1800 kg

C57S/B-O



C57S/B-G



C57S/B-R



243 kg

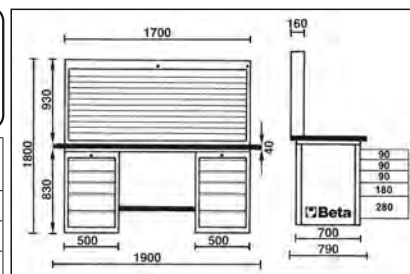

h	max
90 mm	30 kg
180 mm	40 kg
280 mm	40 kg

	€			
C57S/B-O	RAL 2011	6.750,00	1	057001006
C57S/B-G	RAL 7016	6.750,00	1	057001206
C57S/B-R	RAL 3000	6.750,00	1	057001406

## C57SC

bancada de trabalho MasterCargo

- Modelo com dois blocos de gavetas.

Bloco de gavetas composto por 5 gavetas, 588x367 mm, 3 de 90 mm altura, 1 de 180 mm altura e 1 de 280 mm altura, com guias de rolamentos de esferas. Pode ser equipada com tabuleiros. Fecho centralizado.

Plano de trabalho em madeira laminada, plastificada, com três orifícios para torno ref. 1599F/150 - 1599GI/150, extra opcional.



1800 kg



C57S/C-O

h	max
90 mm	30 kg
180 mm	40 kg
280 mm	40 kg

196 kg

	€			
C57S/C-O	RAL 2011	5.200,00	1	057001003
C57S/C-G	RAL 7016	5.200,00	1	057001203
C57S/C-R	RAL 3000	5.200,00	1	057001403



C57S/C-G



C57S/C-R



## C57SP

Armário para ferramentas

Armário para ferramentas, com dois orifícios para fixação à parede.  
Persiana em alumínio com fecho de segurança.  
Três painéis perfurados amovíveis para fixação de ferramentas com ganchos.

60 kg

		€		
C57SP-O	RAL 2011	1.600,00	1	057001020
C57SP-G	RAL 7016	1.600,00	1	057001220
C57SP-R	RAL 3000	1.600,00	1	057001420



C57SP O

1700 mm

930 mm



570



C57SP G



C57SP R

## 5700LAMP

lâmpada para bancada MasterCargo

- Estrutura robusta constituída por quatro elementos metálicos e fornecimento dos parafusos de fixação.
- Suporte de lâmpada com lâmpada LED 1120-lumen, 4000K, 14W.
- Alimentação 230V.
- Fornecido sem cabo.

9 kg

		€		
5700LAMP		393,00	1	057000005

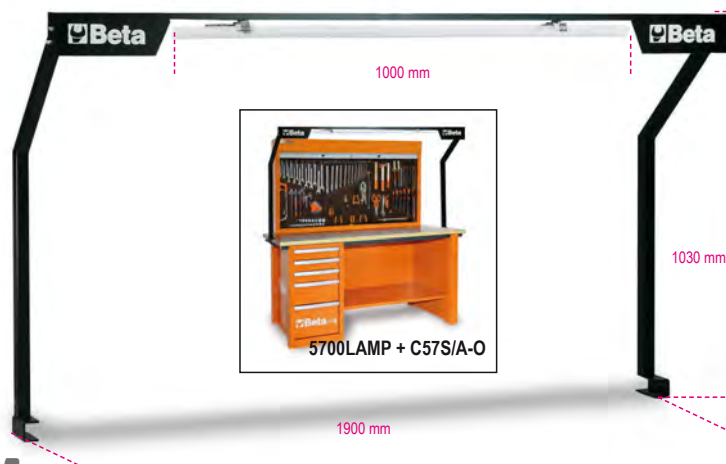

5700LAMP + C57S/A-O

## C58P

painel para ferramentas

- Armário para ferramentas, com dois orifícios para fixação à parede.
- Persiana em alumínio pintado com fechadura.
- Dois painéis de ferramentas perfurados amovíveis.

47,5 kg

		€		
C58P-O	RAL 2011	1.210,00	1	058000221
C58P-G	RAL 7016	1.210,00	1	058000222
C58P-R	RAL 3000	1.210,00	1	058000223



C58P-G



C58P-R

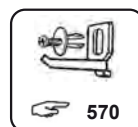

570



C58P-O

1360 mm

930 mm

## PV

painel para ferramentas

	LxA mm		€		
PV1	1000x920	10,2	226,00	1	088880010
PV1,5	1500x920	14,2	299,00	1	088880015

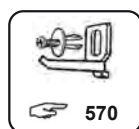

570

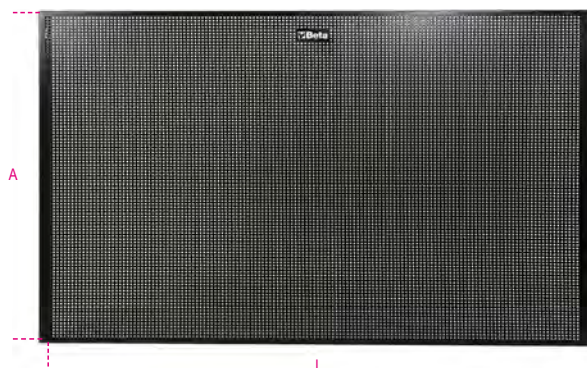

# BANCADAS DE TRABALHO MODULARES

A Beta lançou a nova gama de bancadas de trabalho, MODULAR, concebidas para permitir aos profissionais configurar os seus locais de trabalho, adaptando-os às suas necessidades individuais.

A linha possui uma ampla variedade de **combinações pré-montadas**, em alternativa, pode personalizar totalmente a sua configuração, incluindo bancadas, pernas, carros e caixas de ferramentas, sistemas de parede para ferramentas e acessórios. A bancada com 75 cm de profundidade significa ter disponível uma superfície de trabalho grande, cómoda e funcional. Pode ser equipada com um torno, permitindo assim a realização de trabalhos pesados.

A nova gama MODULAR, concebida de acordo com os mais recentes estudos de ergonomia é reforçada pela reconhecida robustez e qualidade da Beta, destacando-se assim como um parceiro de trabalho essencial.



Aceda a [www.beta-tools.com](http://www.beta-tools.com)



para configurar a sua oficina online

## CARRO DE FERRAMENTAS



## PAINÉIS PERFURADOS



## PLANO DE TRABALHO

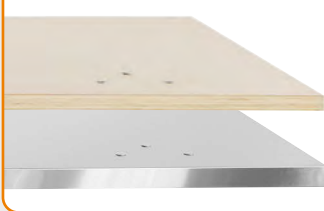

PERNA

## C58BC-W1,6

bancada de trabalho simples com plano de trabalho em madeira, 1,6 m de comprimento

Especificações:

- Plano de trabalho (1600x750 mm), em madeira laminada, com 38 mm de espessura
- Estrutura em aço com 4 pés de apoio
- Orifícios para torno (1599F/150 - 1599GI/150, opcional)
- Meia prateleira inferior para objetos 1288x335 mm; espessura: 40 mm
- Possibilidade de fixação ao solo
- Capacidade de carga estática: 1.000 kg, distribuída uniformemente

Possibilidade de adicionar os seguintes acessórios:

- Painel lateral perfurado C58PFL
- Arestas anti-queda, 1600 mm, C58BAC 1,6

61 kg

1000 kg

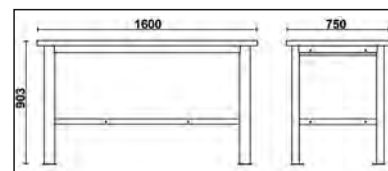

C58BC-W1,6

€ 645,00 1 058000601

## C58BC-X1,6

bancada de trabalho simples com plano de trabalho em MDF revestido a aço inox, 1,6 m de comprimento

Especificações:

- Plano de trabalho (1600x750 mm) em MDF revestido a aço inox, 38 mm de espessura
- Estrutura em aço com 4 pés de apoio
- Orifícios para torno (1599F/150 - 1599GI/150, opcional)
- Meia prateleira inferior para objetos, 1288x335 mm; espessura: 40 mm
- Possibilidade de fixação ao solo
- Capacidade de carga estática: 1000 kg, distribuída uniformemente

Possibilidade de adicionar os seguintes acessórios:

- Painel lateral perfurado C58PFL
- Arestas anti-queda, 1600 mm, C58BAC 1,6

74 kg

1000 kg

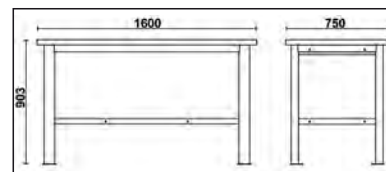

C58BC-X1,6

€ 680,00 1 058000606

## C58BC-W1,6 2C

bancada de trabalho, com 1,6 m de comprimento, com plano de trabalho em madeira e 2 gavetas

Especificações:

- Plano de trabalho (1600x750 mm) em madeira laminada com 38 mm de espessura
- 2 gavetas (367x588 mm) com guias de rolamentos de esferas:
  - 1 gaveta com 70 mm de altura
  - 1 gaveta com 140 mm de altura.
- Fundo das gavetas protegido com tapete de borracha
- Cada gaveta pode conter até 4 tabuleiros maleáveis
- Fechadura frontal centralizada
- Estrutura em aço com 4 pés de apoio
- Orifícios para torno (1599F/150 - 1599GI/150, opcional)
- Meia prateleira inferior para objetos, 1288x335 mm; espessura: 40 mm
- Possibilidade de fixação ao solo
- Capacidade de carga estática: 1000 kg, distribuída uniformemente

Possibilidade de adicionar os seguintes acessórios:

- Painel lateral perfurado C58PFL
- Arestas anti-queda, 1600 mm, C58BAC 1,6

103,5 kg

1000 kg



C58BC-W1,6 2C/O



C58BC-W1,6 2C/A

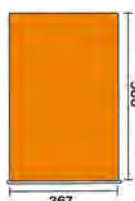

h	max
70 mm	25 kg
140 mm	30 kg

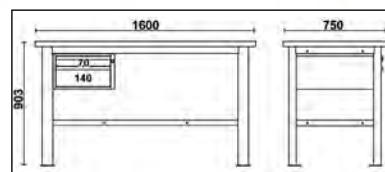

C58BC-W1,6 2C/O 935,00 1 058000611

C58BC-W1,6 2C/A 935,00 1 058000613



## C58BC-W1,6 4C

bancada de trabalho, 1,6 m de comprimento com plano de trabalho em madeira e 4 gavetas

Especificações:

- Plano de trabalho (1600x750 mm) em madeira laminada com 38 mm de espessura
- 4 gavetas (367x588 mm) com guias de rolamentos de esferas:
- 1 gaveta com 210 mm de altura
- 3 gavetas com 70 mm de altura.
- Fundo das gavetas protegido com tapete de borracha
- Cada gaveta pode conter até 4 tabuleiros maleáveis
- Fechadura frontal centralizada
- Estrutura em aço com 4 pés de apoio
- Orifícios para (1599F/150 - 1599GI/150, opcional)
- Meia prateleira inferior para objetos, 1288x335 mm; espessura: 40 mm
- Possibilidade de fixação ao solo
- Capacidade de carga estática: 1000 kg, distribuída uniformemente

Possibilidade de adicionar os seguintes acessórios:

- Painel lateral perfurado C58PFL
- Arestas anti-queda, 1600 mm, C58BAC 1,6

1000 kg



82 kg



h	max
70 mm	25 kg
210 mm	30 kg

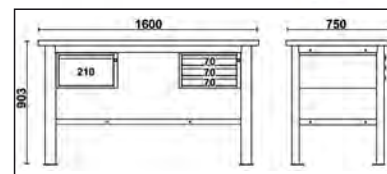

	€		
C58BC-W1,6 4C/O	1.240,00	1	058000612
C58BC-W1,6 4C/A	1.240,00	1	058000614

## C58BC-W2,1

bancada de trabalho simples com plano de trabalho em madeira, 2,1 m de comprimento

Especificações:

- Plano de trabalho (2100x750 mm) em madeira laminada, 38 mm de espessura
- Estrutura em aço com 4 pés de apoio
- Orifícios para torno (1599F/150 - 1599GI/150, opcional)
- Meia prateleira inferior para objetos, 1788x335 mm; espessura: 40 mm
- Possibilidade de fixação ao solo
- Capacidade de carga estática: 800 kg, distribuída uniformemente

Possibilidade de adicionar os seguintes acessórios:

- Painel lateral perfurado C58PFL
- Arestas anti-queda, 2100 mm, C58BAC 2.1

70 kg

800 kg

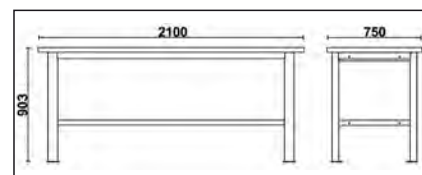

	€		
C58BC-W2,1	760,00	1	058000621

## C58BC-X2,1

bancada de trabalho simples com plano de trabalho em MDF revestido a aço inox, 2,1 m de comprimento

Especificações:

- Plano de trabalho (2100x750 mm) em MDF revestido a aço inox, 38 mm de espessura
- Estrutura em aço com 4 pés de apoio
- Orifícios para torno (1599F/150 - 1599GI/150, opcional)
- Meia prateleira inferior para objetos, 1788x335 mm; espessura: 40 mm
- Possibilidade de fixação ao solo
- Capacidade de carga estática: 1000 kg, distribuída uniformemente

Possibilidade de adicionar os seguintes acessórios:

- Painel lateral perfurado C58PFL
- Arestas anti-queda, 2.100 mm, C58BAC 2.1

800 kg



93 kg

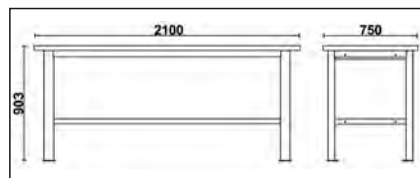

C58BC-X2,1

€ 795,00 1 058000626

## C58BC-W2,1 2C

bancada de trabalho, 2,1 m de comprimento, com plano de trabalho em madeira e 2 gavetas

Especificações:

- Plano de trabalho (2100x750 mm) em madeira laminada com 38 mm de espessura
- 2 gavetas (367x588 mm) com guias de rolamentos de esferas:
  - 1 gaveta com 70 mm de altura
  - 1 gaveta com 140 mm de altura.
- Fundo das gavetas protegido com tapete de borracha
- Cada gaveta pode conter até 4 tabuleiros maleáveis
- Fechadura frontal centralizada
- Estrutura em aço com 4 pés de apoio
- Orifícios para torno (1599F/150 - 1599GI/150, opcional)
- Meia prateleira inferior para objetos, 1788x335 mm; espessura: 40 mm
- Possibilidade de fixação ao solo
- Capacidade de carga estática: 800 kg, distribuída uniformemente

800 kg



C58BC-W2,1 2C/O

Possibilidade de adicionar os seguintes acessórios:

- Painel lateral perfurado C58PFL
- Arestas anti-queda, 2100 mm, C58BAC 2.1

91 kg

RAL 7016



C58BC-W2,1 2C/A

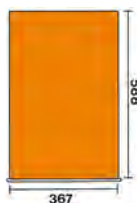

h	max
70 mm	25 kg
140 mm	30 kg

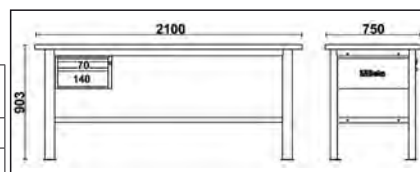

C58BC-W2,1 2C/O

€ 1.050,00 1 058000631

C58BC-W2,1 2C/A

€ 1.050,00 1 058000636

## C58BC-W2,1 4C

bancada de trabalho, 2,1 m de comprimento, com plano de trabalho em madeira e 4 gavetas

Especificações:

- Plano de trabalho (2100x750 mm) em madeira laminada com 38 mm de espessura
- 4 gavetas (367x588 mm) com guias de rolamentos de esferas:  
2 gavetas com 70 mm de altura  
2 gavetas com 140 mm de altura.
- Fundo das gavetas protegido com tapete de borracha
- Cada gaveta pode conter até 4 tabuleiros maleáveis
- Fechadura frontal centralizada
- Estrutura em aço com 4 pés de apoio
- Orifícios para torno (1599F/150 - 1599GI/150, opcional)
- 2 meias prateleiras inferiores para objetos, 1788x335 mm; espessura: 40 mm
- Capacidade de carga estática: 800 kg, distribuída uniformemente
- Possibilidade de fixação ao solo

Possibilidade de adicionar os seguintes acessórios:

- Painel lateral perfurado C58PFL
- Arestas anti-queda, 2100 mm, C58BAC 2.1

118 kg

	€		
C58BC-W2,1 4C/O	1.340,00	1	058000632
C58BC-W2,1 4C/A	1.340,00	1	058000637

800 kg



h	max
70 mm	25 kg
140 mm	30 kg

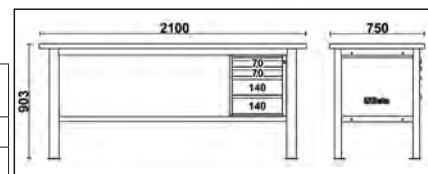

## C58BC-W2,1 4CA

bancada de trabalho, 2,1 m de comprimento, com plano de trabalho em madeira, 4 gavetas e módulo de porta

Especificações:

- Plano de trabalho (2100x750 mm) em madeira laminada com 38 mm de espessura
- 4 gavetas (367x588 mm) com guias de rolamentos de esferas:  
2 gavetas com 70 mm de altura  
2 gavetas com 140 mm de altura.
- Fundo das gavetas protegido com tapete de borracha
- Cada gaveta pode conter até 4 tabuleiros maleáveis
- Fechadura frontal centralizada
- 1 módulo com porta e fechadura
- Estrutura em aço com 4 pés de apoio
- Orifícios para torno (1599F/150 - 1599GI/150, opcional)
- 2 meias prateleiras inferiores para objetos, 1788x335 mm; espessura: 40 mm
- Capacidade de carga estática: 800 kg, distribuída uniformemente
- Possibilidade de fixação ao solo

Possibilidade de adicionar os seguintes acessórios:

- Painel lateral perfurado C58PFL
- Arestas anti-queda, 2100 mm, C58BAC 2.1

133 kg

	€		
C58BC-W2,1 4CA/O	1.570,00	1	058000633
C58BC-W2,1 4CA/A	1.570,00	1	058000638

800 kg



h	max
70 mm	25 kg
140 mm	30 kg

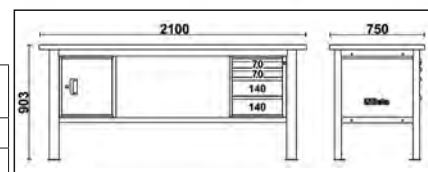



## C58BC-W2,1 6CA

bancada de trabalho, 2,1 m de comprimento, com plano de trabalho em madeira, 6 gavetas e módulo de porta

Especificações:

- Plano de trabalho (2100x750 mm) em madeira laminada com 38 mm de espessura
- 6 gavetas (367x588 mm) com guias de rolamentos de esferas:
  - 1 gaveta com 210 mm de altura
  - 4 gavetas com 70 mm de altura
  - 1 gaveta com 140 mm de altura.
- Fundo das gavetas protegido com tapete de borracha
- Cada gaveta pode conter até 4 tabuleiros maleáveis
- Fechadura frontal centralizada
- 1 módulo com porta e fechadura
- Estrutura em aço com 4 pés de apoio
- Orifícios para torno (1599F/150 - 1599GI/150, opcional)
- 2 meias prateleiras inferiores para objetos, 1788x335 mm; espessura: 40 mm
- Capacidade de carga estática: 800 kg, distribuída uniformemente
- Possibilidade de fixação ao solo

Possibilidade de adicionar os seguintes acessórios:

- Painel lateral perfurado C58PFL
- Arestas anti-queda, 2100 mm, C58BAC 2.1

162 kg

800 kg



h	max
70 mm	25 kg
140 mm	30 kg
210 mm	30 kg

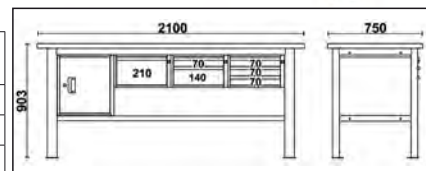

	€		
C58BC-W2,1 6CA/O	2.010,00	1	058000634
C58BC-W2,1 6CA/A	2.010,00	1	058000639

## C58BC-W2,1 8CA

bancada de trabalho, 2,1 m de comprimento, com plano de trabalho em madeira, 8 gavetas e módulo de porta

Especificações:

- Plano de trabalho (2100x750 mm) em madeira laminada com 38 mm de espessura
- 8 gavetas (367x588 mm) com guias de rolamentos de esferas:
  - 5 gaveta com 70 mm de altura
  - 2 gavetas com 140 mm de altura
  - 1 gaveta com 210 mm de altura.
- Fundo das gavetas protegido com tapete de borracha
- Cada gaveta pode conter até 4 tabuleiros maleáveis
- Fechadura frontal centralizada
- 1 módulo com porta e fechadura
- Estrutura em aço com 4 pés de apoio
- Orifícios para torno (1599F/150 - 1599GI/150, opcional)
- 2 meias prateleiras inferiores para objetos, 1788x335 mm; espessura: 40 mm
- Capacidade de carga estática: 800 kg, distribuída uniformemente
- Possibilidade de fixação ao solo

Possibilidade de adicionar os seguintes acessórios:

- Painel lateral perfurado C58PFL
- Arestas anti-queda, 2100 mm, C58BAC 2.1

174 kg

800 kg



h	max
70 mm	25 kg
140 mm	30 kg
210 mm	30 kg

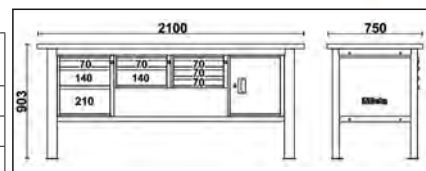

	€		
C58BC-W2,1 8CA/O	2.160,00	1	058000635
C58BC-W2,1 8CA/A	2.160,00	1	058000640

## C58BC-X2,1 4C

bancada de trabalho, 2,1 m de comprimento, com plano de trabalho em MDF revestido a aço inox e 4 gavetas

Especificações:

- Plano de trabalho (2100x750 mm) em MDF revestido a aço inox com 38 mm de espessura
- 4 gavetas (367x588 mm) com guias de rolamentos de esferas:
  - 2 gaveta com 70 mm de altura
  - 2 gavetas com 140 mm de altura
- Fundo das gavetas protegido com tapete de borracha
- Cada gaveta pode conter até 4 tabuleiros maleáveis
- Fechadura frontal centralizada
- Estrutura em aço com 4 pés de apoio
- Orifícios para torno (1599F/150 - 1599GI/150, opcional)
- 2 meias prateleiras inferiores para objetos, 1788x335 mm; espessura: 40 mm
- Capacidade de carga estática: 800 kg, distribuída uniformemente
- Possibilidade de fixação ao solo

Possibilidade de adicionar os seguintes acessórios:

- Painel lateral perfurado C58PFL
- Arestas anti-queda, 2100 mm, C58BAC 2.1

141 kg

	€		
C58BC-X2,1 4C/O	1.370,00	1	058000623
C58BC-X2,1 4C/A	1.370,00	1	058000627

800 kg

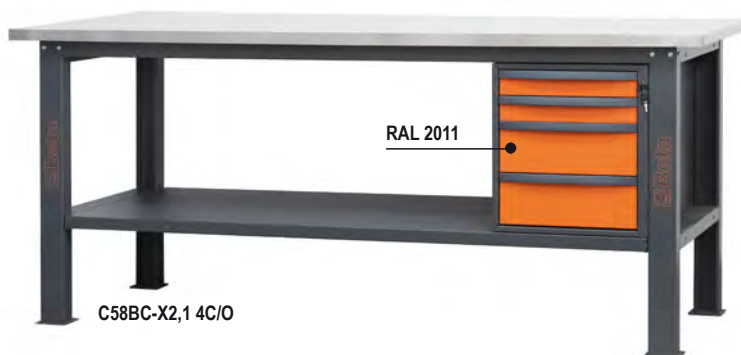

C58BC-X2,1 4C/O

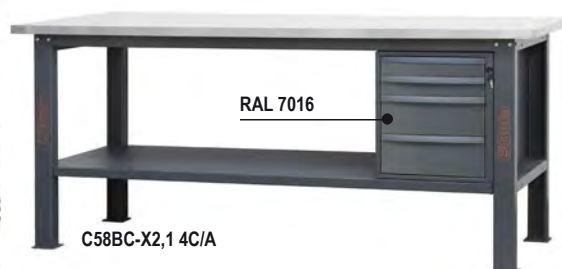

C58BC-X2,1 4C/A

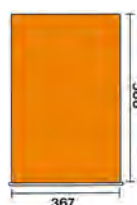

h	max
70 mm	25 kg
140 mm	30 kg

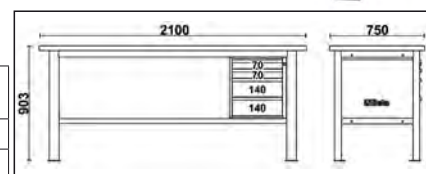

## C58BC-X2,1 4CA

bancada de trabalho, 2,1 m de comprimento, com plano de trabalho em MDF revestido a aço inox, 4 gavetas e módulo de porta

Especificações:

- Plano de trabalho (2100x750 mm) em MDF revestido a aço inox com 38 mm de espessura
- 4 gavetas (367x588 mm) com guias de rolamentos de esferas:
  - 2 gaveta com 70 mm de altura
  - 2 gavetas com 140 mm de altura
- Fundo das gavetas protegido com tapete de borracha
- Cada gaveta pode conter até 4 tabuleiros maleáveis
- Fechadura frontal centralizada
- 1 módulo com porta e fechadura
- Estrutura em aço com 4 pés de apoio
- Orifícios para torno (1599F/150 - 1599GI/150, opcional)
- 2 meias prateleiras inferiores para objetos, 1788x335 mm; espessura: 40 mm
- Capacidade de carga estática: 800 kg, distribuída uniformemente
- Possibilidade de fixação ao solo

Possibilidade de adicionar os seguintes acessórios:

- Painel lateral perfurado C58PFL
- Arestas anti-queda, 2100 mm, C58BAC 2.1

155,5 kg

	€		
C58BC-X2,1 4CA/O	1.600,00	1	058000624
C58BC-X2,1 4CA/A	1.600,00	1	058000628

800 kg



C58BC-X2,1 4CA/O

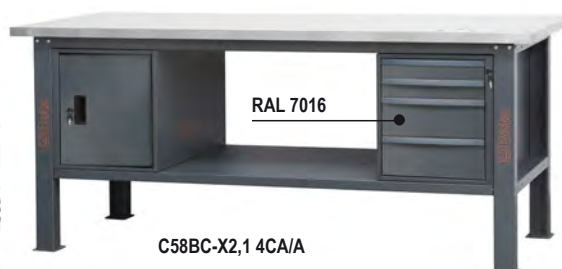

C58BC-X2,1 4CA/A

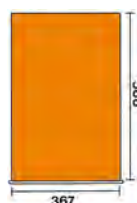

h	max
70 mm	25 kg
140 mm	30 kg

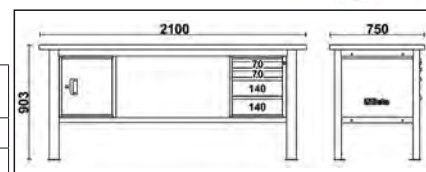

## C58BC-X2,1 8CA

bancada de trabalho, 2,1 m de comprimento, com plano de trabalho em MDF revestido a aço inox, 8 gavetas e módulo de porta

Especificações:

- Plano de trabalho (2100x750 mm) em MDF revestido a aço inox com 38 mm de espessura
- 8 gavetas (367x588 mm) com guias de rolamentos de esferas:
  - 5 gaveta com 70 mm de altura
  - 2 gavetas com 140 mm de altura
  - 1 gavetas com 210 mm de altura
- Fundo das gavetas protegido com tapete de borracha
- Cada gaveta pode conter até 4 tabuleiros maleáveis
- Fechadura frontal centralizada
- 1 módulo com porta e fechadura
- Estrutura em aço com 2 pés de apoio
- Orifícios para torno (1599F/150 - 1599GI/150, opcional)
- 2 meias prateleiras inferiores para objetos, 1788x335 mm; espessura: 40 mm
- Capacidade de carga estática: 800 kg, distribuída uniformemente
- Possibilidade de fixação ao solo

Possibilidade de adicionar os seguintes acessórios:

- Painel lateral perfurado C58PFL
- Arestas anti-queda, 2100 mm, C58BAC 2.1

197 kg

	€		
C58BC-X2,1 8CA/O	2.190,00	1	058000625
C58BC-X2,1 8CA/A	2.190,00	1	058000629



h	max
70 mm	25 kg
140 mm	30 kg
210 mm	30 kg

## C58PLT-W 1,6

plano de trabalho (1600x750 mm) em madeira laminada, para bancadas de trabalho modulares C58BC

- Espessura: 38 mm
- Orifícios para torno (1599F/150 - 1599GI/150, opcional)

35,5 kg

	€		
C58PLT-W 1,6	349,00	1	058000641



## C58PLT-X 1,6

plano de trabalho (1600x750 mm) em MDF revestido a aço inox, para bancadas de trabalho modulares C58BC

- Espessura: 38 mm
- Orifícios para torno (1599F/150 - 1599GI/150, opcional)

48,5 kg

	€		
C58PLT-X 1,6	384,00	1	058000646



## C58PLT-W 2,1

plano de trabalho (2100x750 mm) em madeira laminada, para bancadas de trabalho modulares C58BC

- Espessura: 38 mm
- Orifícios para torno (1599F/150 - 1599GI/150, opcional)

41 kg

	€		
C58PLT-W 2,1	436,00	1	058000651





## C58PLT-X 2,1

plano de trabalho (2100x750 mm) em MDF revestido a aço inox, para bancadas de trabalho modulares C58BC

- Espessura: 38 mm
- Orifícios para torno (1599F/150 - 1599GI/150, opcional)



63,5 kg

C58PLT-X 2,1

€ 469,00 1 058000656

## C58GF

perna de altura fixa, para bancadas de trabalho modulares C58BC

- Estrutura em chapa robusta, com orifícios para fixação de prateleiras
- Altura: 866 mm
- Possibilidade de fixação ao solo
- Cor: cinzento antracite RAL7016
- Capacidade de carga: 400 kg

8 kg



C58GF

€ 98,50 1 058000660

## C58GT

perna com regulação vertical, para bancadas de trabalho modulares C58BC

A altura com regulação vertical permite satisfazer as necessidades individuais, o que se traduz em bancadas de trabalho perfeitamente ergonómicas.

- Estrutura em chapa robusta, com orifícios para fixação de prateleiras
- Altura: 715 ÷ 1065 mm; distância entre orifícios: 25 mm
- Possibilidade de fixação ao solo
- Cor: cinzento antracite RAL7016
- Capacidade de carga: 400 kg

10 kg



C58GT

€ 117,00 1 058000661

## C58GRGM

perna com rodízios direcionáveis e pega, para bancadas de trabalho modulares C58BC

- Estrutura em chapa robusta, com orifícios para fixação de prateleiras
- 2 rodízios direcionáveis, Ø 125 mm, com travões
- Pega lateral para transporte cómodo da bancada de trabalho
- Altura total: 824 mm, incluindo rodízios
- Cor: cinzento antracite RAL7016
- Capacidade de carga: 400 kg

9,5 kg



C58GRGM

€ 177,00 1 058000662

## C58GRF

perna com rodízios fixos, para bancadas de trabalho modulares C58BC

- Estrutura em chapa robusta, com orifícios para fixação de prateleiras
- 2 rodízios fixos, Ø 125 mm
- Altura total: 824 mm, incluindo rodízios
- Cor: cinzento antracite RAL7016
- Capacidade de carga: 400 kg

8,5 kg



C58GRF

€ 150,00 1 058000663

## C58CS 1C

carro de ferramentas, 257 mm de altura, com 1 gaveta, para bancadas de trabalho modulares C58BC

- 1 gaveta totalmente amovível (367x588 mm), com guias de rolamentos de esferas, 210 mm de altura
- Fechadura frontal centralizada
- Fundo das gavetas protegido com tapete de borracha
- Cada gaveta pode conter até 4 tabuleiros maleáveis

18,5 kg



h		max
210 mm		30 kg

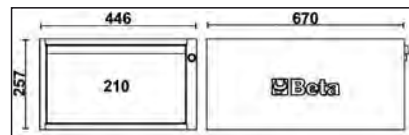

C58CS/O 1C	€ 259,00	1	058000671
C58CS/A 1C	€ 259,00	1	058000674

## C58CS 2C

carro de ferramentas, 257 mm de altura, com 2 gavetas, para bancadas de trabalho modulares C58BC

- 2 gavetas totalmente amovíveis (367x588 mm), com guias de rolamentos de esferas:

1 gaveta com 70 mm de altura

1 gaveta com 140 mm de altura

- Fechadura frontal centralizada
- Fundo das gavetas protegido com tapete de borracha
- Cada gaveta pode conter até 4 tabuleiros maleáveis

21 kg



h		max
70 mm		25 kg
140 mm		30 kg

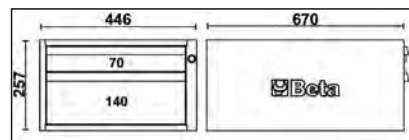

C58CS/O 2C	€ 289,00	1	058000672
C58CS/A 2C	€ 289,00	1	058000675

## C58CS 3C

carro de ferramentas, 257 mm de altura, com 3 gavetas, para bancadas de trabalho modulares C58BC

- 3 gavetas totalmente amovíveis (367x588 mm), com guias de rolamentos de esferas, com 70 mm de altura
- Fechadura frontal centralizada
- Fundo das gavetas protegido com tapete de borracha
- Cada gaveta pode conter até 4 tabuleiros maleáveis

24 kg



h		max
70 mm		25 kg

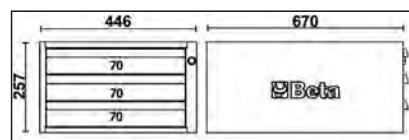

C58CS/O 3C	€ 336,00	1	058000673
C58CS/A 3C	€ 336,00	1	058000676

## C58MA

módulo, 479 mm de altura, com porta, para bancadas de trabalho modulares C58BC

- Fechadura frontal
- Porta em chapa pode ser instalada com abertura à direita ou à esquerda
- Dimensões úteis interiores: 440x640x447 mm

15 kg

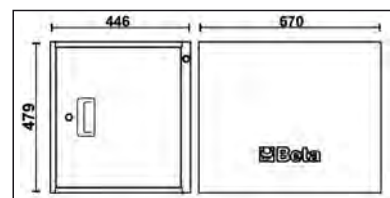
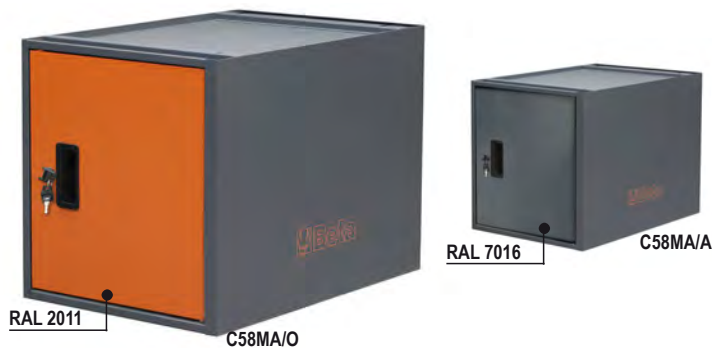

	€		
C58MA/O	228,00	1	058000680
C58MA/A	228,00	1	058000681

## C58CSH 3C

bloco de ferramentas, 479 mm de altura, com 3 gavetas, para bancadas de trabalho modulares C58BC

- 3 gavetas totalmente amovíveis (367x588 mm), com guias de rolamentos de esferas:
- 1 gaveta com 70 mm de altura
- 1 gaveta com 140 mm de altura
- 1 gaveta com 210 mm de altura
- Fechadura frontal centralizada
- Fundo das gavetas protegido com tapete de borracha
- Cada gaveta pode conter até 4 tabuleiros maleáveis

31 kg

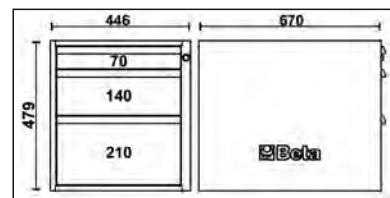

h	max
70 mm	25 kg
140 mm	30 kg
210 mm	30 kg

	€		
C58CSH/O 3C	411,00	1	058000682
C58CSH/A 3C	411,00	1	058000686

## C58CSH 4C

bloco de ferramentas, 479 mm de altura, com 4 gavetas, para bancadas de trabalho modulares C58BC

- 4 gavetas totalmente amovíveis (367x588 mm), com guias de rolamentos de esferas:
- 2 gavetas com 70 mm de altura
- 2 gavetas com 140 mm de altura
- Fechadura frontal centralizada
- Fundo das gavetas protegido com tapete de borracha
- Cada gaveta pode conter até 4 tabuleiros maleáveis

35 kg

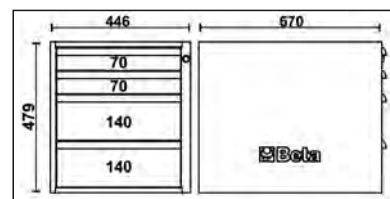

h	max
70 mm	25 kg
140 mm	30 kg

	€		
C58CSH/O 4C	450,00	1	058000683
C58CSH/A 4C	450,00	1	058000687



## C58CSH 5C

bloco de ferramentas, 479 mm de altura, com 5 gavetas, para bancadas de trabalho modulares C58BC

- 5 gavetas totalmente amovíveis (367x588 mm), com guias de rolamentos de esferas:
- 4 gavetas com 70 mm de altura
- 1 gaveta com 140 mm de altura
- Fechadura frontal centralizada
- Fundo das gavetas protegido com tapete de borracha
- Cada gaveta pode conter até 4 tabuleiros maleáveis

37,5 kg

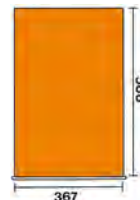

RAL 2011

C58CSH/O 5C

RAL 7016

C58CSH/A 5C

	€		
C58CSH/O 5C	489,00	1	058000684
C58CSH/A 5C	489,00	1	058000688

h	max
70 mm	25 kg
140 mm	30kg

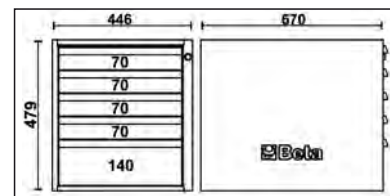

## C58CSH 6C

bloco de ferramentas, 479 mm de altura, com 6 gavetas, para bancadas de trabalho modulares C58BC

- 6 gavetas totalmente amovíveis (367x588 mm), com guias de rolamentos de esferas, com 70 mm de altura
- Fechadura frontal centralizada
- Fundo das gavetas protegido com tapete de borracha
- Cada gaveta pode conter até 4 tabuleiros maleáveis

40 kg



RAL 2011

C58CSH/O 6C

RAL 7016

C58CSH/A 6C

	€		
C58CSH/O 6C	530,00	1	058000685
C58CSH/A 6C	530,00	1	058000689

h	max
70 mm	25 kg

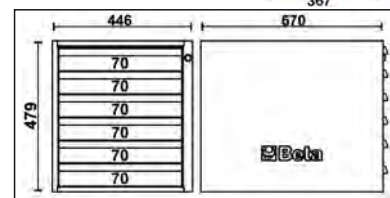

## C58K/2PF-1,6M

kit de 2 painéis perfurados para ferramentas com estrutura, para bancadas de trabalho modulares C58BC, 1,6 m de comprimento

Kit inclui:

- 3 apoios
- 3 suportes de 400 mm
- 2 suportes de 765 mm; permite instalar 1 tomada múltipla de 19" (não incluída)
- 2 painéis de ferramentas perfurados, 765x25x400 mm

14,4 kg

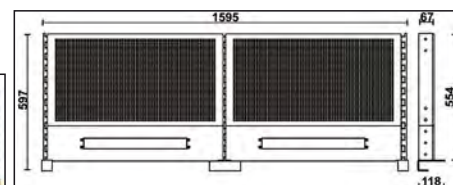

	€		
C58K/2PF-1,6M	382,00	1	058000802

## C58K/4PF-1,6M

kit de 4 painéis perfurados para ferramentas com estrutura, para bancadas de trabalho modulares C58BC, 1,6 m de comprimento

Kit inclui:

- 3 apoios
- 6 suportes de 400 mm
- 2 suportes de 765 mm; permite instalar 1 tomada múltipla de 19" (não incluída)
- 4 painéis de ferramentas perfurados, 765x25x400 mm

23,9 kg

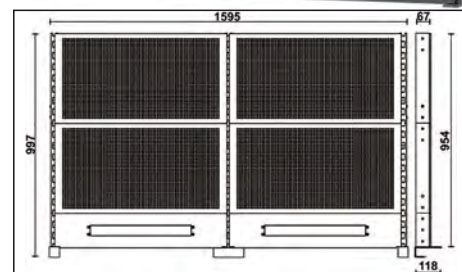
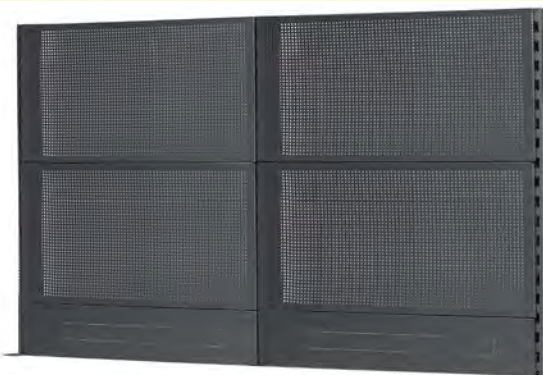

C58K/4PF-1,6M

€ 645,00 1 058000804

## C58K/2PF-2,1M

kit de 2 painéis perfurados para ferramentas com estrutura, para bancadas de trabalho modulares C58BC, 2,1 m de comprimento

Kit inclui:

- 3 apoios
- 3 suportes de 400 mm
- 2 suportes de 1015 mm; permite instalar 1 tomada múltipla de 19" (não incluída)
- 2 painéis de ferramentas perfurados, 1015x25x400 mm

17 kg

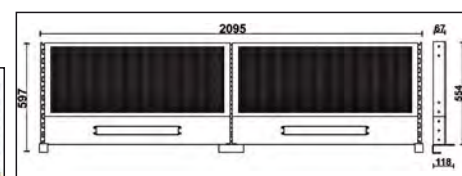
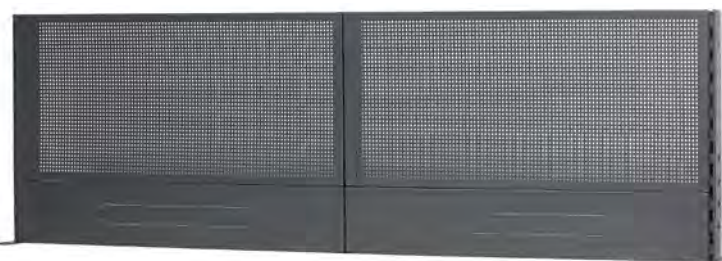

C58K/2PF-2,1M

€ 415,00 1 058000812

## C58K/4PF-2,1M

kit de 4 painéis perfurados para ferramentas com estrutura, para bancadas de trabalho modulares C58BC, 2,1 m de comprimento

Kit inclui:

- 3 apoios
- 6 suportes de 400 mm
- 2 suportes de 1015 mm; permite instalar 1 tomada múltipla de 19" (não incluída)
- 4 painéis de ferramentas perfurados, 1015x25x400 mm

28,2 kg

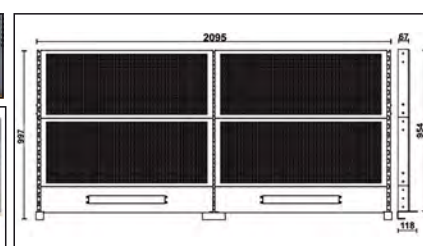

C58K/4PF-2,1M

€ 695,00 1 058000814

## C58SP 1,6

meia prateleira de apoio, para bancadas de trabalho modulares C58BC, 1,6 m de comprimento

- Espessura: 40 mm
- Material de fixação incluído

9,7 kg

C58SP 1,6 € 97,50 1 058000690



## C58SP 2,1

meia prateleira de apoio, para bancadas de trabalho modulares C58BC, 2,1 m de comprimento

- Espessura: 40 mm
- Material de fixação incluído

13,3 kg

C58SP 2,1 € 128,00 1 058000691



## C58BAC 1,6

arestas anti-queda para bancadas de trabalho modulares C58BC, 1,6 m de comprimento

- Permite instalar 2 tomadas elétricas e 1 tomada múltipla 19" (não incluídas)
- Dimensões: 1600x55x120 mm

4,5 kg

C58BAC 1,6 € 54,50 1 058000692



## C58BAC 2,1

arestas anti-queda para bancadas de trabalho modulares C58BC, 2,1 m de comprimento

- Permite instalar 2 tomadas elétricas e 1 tomada múltipla 19" (não incluídas)
- Dimensões: 2100x55x120 mm

5,8 kg

C58BAC 2,1 € 64,50 1 058000693



## C58PFL

painel lateral perfurado para bancadas de trabalho modulares C58BC

- Dimensões: 560x25x545 mm
- Material de fixação incluído

1,8 kg

C58PFL € 62,50 1 058000696

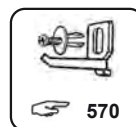



## C58MP-0,8M

prateleira para bancadas de trabalho modulares C58BC, 1,6 m de comprimento

- Dimensões: 774x335 mm
- Concebida para aplicação de perfis de alumínio com fita LED artigo 5000 RSC50 2.0/PLEDC ou 5000 RSC50 2.0/PLED-ST (opcional), para iluminar a área de trabalho

5 3,5 kg



C58MP-0,8M

€ 68,00 1 058000840

## C58MP-1M

prateleira para bancadas de trabalho modulares C58BC, 2,1 m de comprimento

- Dimensões: 1024x335 mm
- Concebida para aplicação de perfis de alumínio com fita LED artigo 5000 RSC50 2.0/PLEDC ou 5000 RSC50 2.0/PLED-ST (opcional), para iluminar a área de trabalho

5 4,5 kg



C58MP-1M

€ 78,50 1 058000841

## C58BLP-1,6M

calha para lâmpada LED, para bancadas de trabalho modulares C58BC, 1,6 m de comprimento

- Comprimento da estrutura: 1550 mm
- Pode ser fornecida com 1 lâmpada LED C58PLED-150 (opcional)

5 5,2 kg



C58BLP-1,6M

€ 89,50 1 058000850

## C58BLP-1M

calha para lâmpada LED, para bancadas de trabalho modulares, C58BC 2,1 m de comprimento

- Comprimento da estrutura: 1024 mm
- Pode ser fornecida com 1 lâmpada LED C58PLED-90 (opcional)
- Para completar a montagem do banco de 2,1 m, é necessário encomendar 2 unidades

5 3,8 kg



C58BLP-1M

€ 74,50 1 058000851

## C58PLED-150

lâmpada LED para bancadas de trabalho modulares C58BC, 1,6 m de comprimento

- Dimensões: 1500x25x78 mm
- Potência: 48W
- Brilho: 4320 lumens
- Temperatura de luz: 6400k
- Feixe de luz: 180°
- Grau de proteção: IP20
- Duração média: >20.000 horas
- Temperatura de funcionamento: -10 °C ÷ +45 °C
- Voltagem de funcionamento: 220-240AC, 50/60 Hz
- Fornecida com ganchos de fixação

5 540 g



CC

C58PLED-150

€ 50,50 1 058000860

## C58PLED-90

Lâmpada LED para bancadas de trabalho modulares C58BC, 2,1 m de comprimento

CE

- Dimensões: 900x25x78 mm
- Potência: 24W
- Brilho: 2200 lumens
- Temperatura de luz: 6400k
- Feixe de luz: 180°
- Grau de proteção: IP20
- Duração média: >20.000 horas
- Temperatura de funcionamento: -10 °C ÷ +45 °C
- Voltagem de funcionamento: 220-240AC, 50/60 Hz
- Fornecida com ganchos de fixação



340 g

C58PLED-90

€ 31,50 1 058000861

## C56

bancada de trabalho

- Plano de trabalho em chapa galvanizada com rebordos salientes
- Estrutura em aço com 6 pernas de suporte
- Capacidade de carga estática: 1.200 kg
- Compatível com armário para ferramentas C57P; não permite fixação ao plano de trabalho
- Duas gavetas com fechadura
- Pode ser fixo ao pavimento

82 kg



		€		
C56-O	RAL 2011	1.130,00	1	056000201
C56-G	RAL 7016	1.130,00	1	056000202
C56-R	RAL 3000	1.130,00	1	056000203

## C56W

bancada de trabalho com tampo em madeira

- Tampo em contraplacado com orifícios para torno (1599F/125 - 1599GI/125, opcional).
- Estrutura em aço com 6 pernas de apoio
- Capacidade de carga, estacionária: 1,200 kg
- Adaptável ao painel de ferramentas C57P; não pode ser fixo na superfície de trabalho.
- Duas gavetas com fechadura.
- Possibilidade de fixação ao solo.

86 kg



		€		
C56W-O	RAL 2011	1.330,00	1	056000251
C56W-G	RAL 7016	1.330,00	1	056000252
C56W-R	RAL 3000	1.330,00	1	056000253

## C59A

Bancada de trabalho "Endurance" com 1 módulo com 6 gavetas

Características principais:

- Tampo em madeira prensada com orifícios para torno ref. 1599F/125 - 1599GI/125 (opcional extra).
- 6 gavetas (588x367 mm) com guias de rolamentos de esferas:
- 4 gavetas, 70 mm altura (capacidade máx.: 25 kg)
- 1 gaveta, 140 mm altura (capacidade máx.: 30 kg)
- 1 gaveta, 280 mm altura (capacidade máx.: 35 kg)
- Base das gavetas protegida com tapete em borracha.
- Pannel frontal das gavetas em nylon.
- As gavetas podem ser equipadas com tabuleiros.
- Fecho frontal centralizado.
- Prateleira inferior.
- Pode ser equipada com suporte para rolo de papel (2400 RSC24/PC) e porta-garrafas (2400 RSC24/PF-), extras opcionais.

115 kg

		€		
C59A-O	RAL 2011 - 7016	2.140,00	1	059000011
C59A-A	RAL 7016	2.140,00	1	059000031
C59A-R	RAL 3000 - 7016	2.140,00	1	059000051



C59A-O



1500 kg



C59A-A



C59A-R

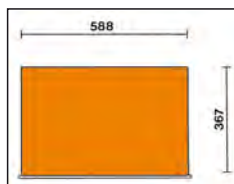

h	max
70 mm	25 kg
140 mm	30 kg
280 mm	35 kg

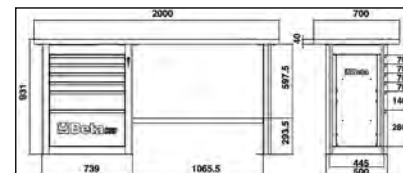

## C59B

Bancada de trabalho "Endurance" com 2 módulos com 6 gavetas

Características principais:

- Tampo em madeira prensada com orifícios para torno ref. 1599F/125 - 1599GI/125 (extra opcional).
- 12 gavetas (588x367 mm) com guias de rolamentos de esferas:
- 8 gavetas, 70 mm altura
- 2 gavetas, 140 mm altura
- 2 gavetas, 280 mm altura
- Base das gavetas protegida com tapete em borracha.
- As gavetas podem ser equipadas com tabuleiros.
- Fecho frontal centralizado.
- Prateleira inferior.
- Pode ser equipada com suporte para rolo de papel (2400 RSC24/PC) e porta-garrafas (2400 RSC24/PF-), extras opcionais.

155 kg

		€		
C59B-O	RAL 2011 - 7016	2.840,00	1	059000012
C59B-R	RAL 3000 - 7016	2.840,00	1	059000052
C59B-A	RAL 7016	2.840,00	1	059000032

1500 kg



C59B-O



C59B-A



C59B-R

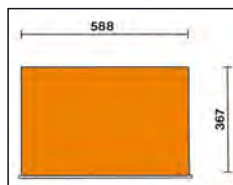

h	max
70 mm	25 kg
140 mm	30 kg
280 mm	35 kg

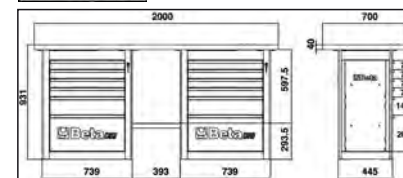



## C59C

Bancada de trabalho "Endurance" com 1 módulo com 6 gavetas, modelo curto

### Características principais:

- Tampo em madeira prensada com orifícios para torno ref. 1599F/125 - 1599GI/125 (extra opcional).
  - 6 gavetas (588x367 mm) com guias de rolamentos de esferas:
- 4 gavetas, 70 mm altura  
 1 gaveta, 140 mm altura  
 1 gaveta, 280 mm altura
- Base das gavetas protegida com tapete em borracha.
  - As gavetas podem ser equipadas com tabuleiros.
  - Fecho frontal centralizado.
  - Prateleira inferior.
  - Pode ser equipada com suporte para rolo de papel (2400 RSC24/PC) e porta-garrafas (2400 RSC24/PF-), extras opcionais.

1500 kg



C59C-O



C59C-A



C59C-R

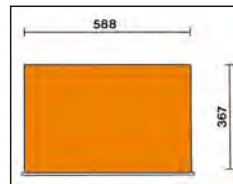

h	max
70 mm	25 kg
140 mm	30 kg
280 mm	35 kg

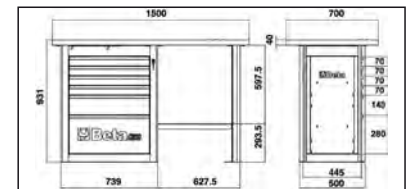

105 kg

		€		
C59C-O	RAL 2011 - 7016	1.930,00	1	059000013
C59C-R	RAL 3000 - 7016	1.930,00	1	059000053
C59C-A	RAL 7016	1.930,00	1	059000033





# BASE MODULAR EM PVC ANTIDERRAPANTE

	PCP	SCG/M	SCG/F
	<b>6x</b>	<b>5x</b>	<b>5x</b>
	<b>8x</b>	<b>6x</b>	<b>6x</b>
	<b>10x</b>	<b>7x</b>	<b>7x</b>

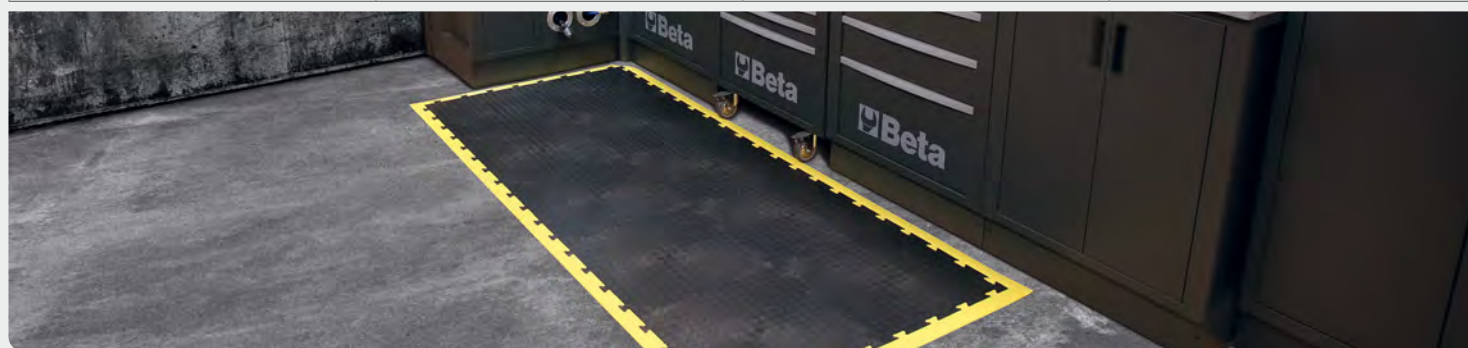

## PCP

base modular em PVC antiderrapante

Um complemento perfeito para as combinações de equipamentos de oficina e bancadas de trabalho da Beta.

Caraterísticas principais:

- Superfície com padrão de relevo "bolha"
- Testado para resistência ao fogo de acordo com a norma EN 13501-1
- Grau anti-derrapante: R10, de acordo com a norma DIN EN 16165
- Resistente à maioria dos solventes e produtos químicos
- Boa insonorização e isolamento térmico
- Limpeza fácil
- Sistema de montagem modular

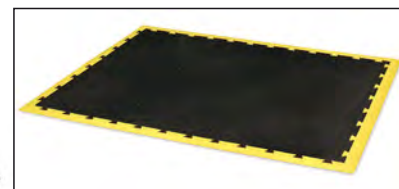
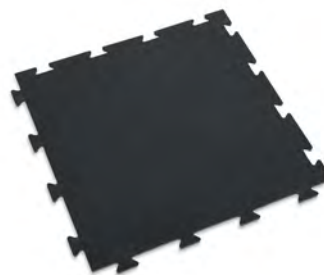

1,4 kg

PCP      mm      €      10      088880800

500x500x80 mm      11,50

## SCG

rampa modular para bases PCP

Um elemento indispensável para marcar os limites das áreas de trabalho.

Caraterísticas principais:

- Calha articulada macho ou fêmea
- A aresta pode ser cortada num ângulo de 45° para fazer um canto
- Cor amarela, para máxima visibilidade
- Com inclinação, para facilitar a subida dos veículos de movimentação de cargas

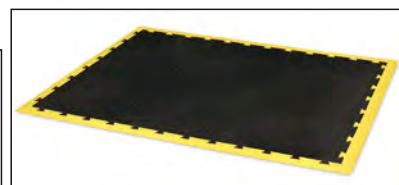

SCG/M      mm      €      10      088880805

SCG/F      mm      9,10      10      088880810

483x50x7,5 mm      9,10





# MOBILIÁRIO PARA OFICINA RSC55



No sentido de dar resposta aos requisitos de um mercado cada vez mais exigente no que se refere à qualidade, design e especificidade, a Beta Utensili desenvolveu o “Racing System C55”, mobiliário modular para oficina à medida das suas necessidades, permitindo-lhe criar um espaço de trabalho moderno.



## QUALIDADE

A melhor qualidade italiana BETA para equipar a sua oficina



## ORGANIZAÇÃO

Um posto de trabalho organizado, sinónimo de trabalho optimizado



## DESIGN

Acabamentos perfeitos para um posto de trabalho organizado e atractivo



## MODULARIDADE

Mobiliário modular para oficina, adequado ao seu espaço e às suas necessidades







# MOBILIÁRIO PARA OFICINA RSC55



**MADE IN ITALY**



Aceda a **www.rsc55.com**  
para configurar a sua oficina online

## AS SUAS CORES PARA A SUA OFICINA!

O RSC55 permite-lhe organizar o Sistema de bancadas e painel de parede com persiana em versão neutra (cinza) e personalizar os inserts verticais coloridos, escolhendo entre 7 fitas adesivas distintas.

**1. Organize os seus módulos numa cor neutra**

**2. Organize o insert vertical**  
Escolha uma cor que lhe agrade ou de acordo com as cores da sua empresa

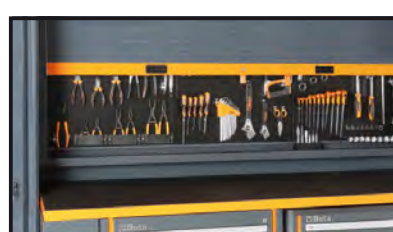
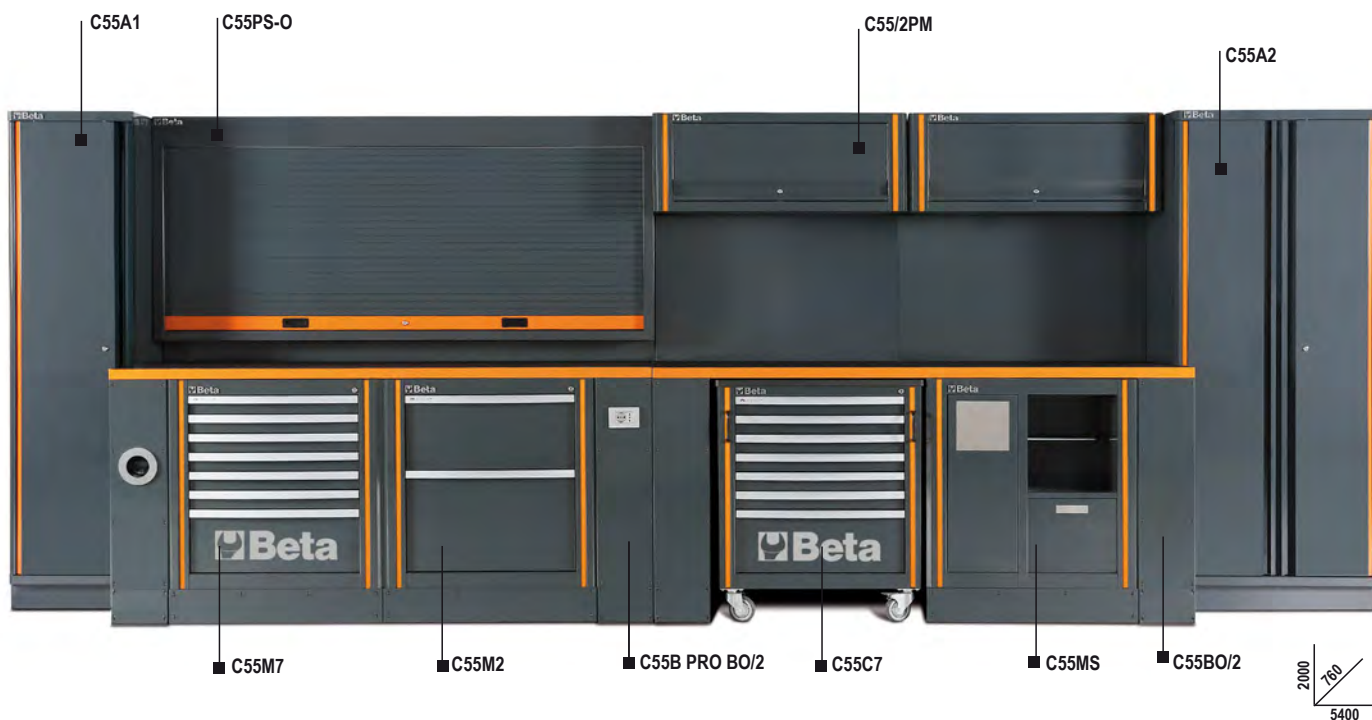

Conjunto completo incluindo:

- Armário de uma porta (C55A1)
- Armário de duas portas (C55A2)
- Bancada de trabalho (C55BO/2)
- Bancada de trabalho com tomadas (C55PRO BO/2)
- Carro com 7 gavetas (C55C7)
- Módulo fixo com 2 gavetas de arrumação (C55M2)
- Módulo fixo com 7 gavetas (C55M7)
- Módulo de serviço fixo (C55MS)
- Painel de ferramentas com armários suspensos (C55/2PM)
- Painel de ferramentas com persiana (C55PS-O)



## C55AB

estante para oficina

Módulo incluindo:

- Armário de duas portas (C55A2)
- Bancada de trabalho (C55BO/2)
- Módulo fixo com 7 gavetas (C55M7)
- Módulo de serviço fixo (C55MS)
- Painel de ferramentas com armários suspensos (C55/2PM)

407 kg



C55AB

€ 11.300,00 1 055000020



## C55PB/3

estante para oficina

Conjunto inclui:

- Bancada de trabalho (C55BO/2)
- Carro com 8 gavetas (C55C8)
- Módulo fixo com 2 gavetas (C55M2)
- Painel de ferramentas com persiana (C55PS-O)

334 kg



C55PB/3

€ 9.550,00 1 055000035





## C55PB-PRO/7

bancada de trabalho, a combinar com mobiliário para oficina RSC55

Composição:

### C55B

Bancada de trabalho com tampo (2050x700 mm) com revestimento ABS anti-impacto e anti-riscos, resistente a óleos e hidrocarbonetos.

Equipada com:

- Furos para torno (1599F/150 - 1599GI/150, opcional)
- Pés com regulação vertical

### C55M7

Módulo fixo com 7 gavetas (588x367 mm) com guias de rolamentos de esferas

- Sistema de abertura em alumínio a todo o comprimento da gaveta
- Bases das gavetas com tapetes de proteção em borracha
- Fechadura frontal centralizada
- Pode ser equipado com tabuleiros flexíveis

### C55MS

Módulo de serviço fixo

- Caixote de lixo incorporado
- Compartimento para rolo de papel
- Gaveta, 305x270 mm

### C55/2PM + C55/PF

Painel de ferramentas com 2 armários suspensos

- 2 armários suspensos, 1024x400x300 mm, com molas de gás
- 2 painéis de ferramentas, 1024x620x25 mm
- 2 painéis de ferramentas perfurados, 1024x620x25 mm

350 kg

C55PB-PRO/7

€ 10.700,00



1



055000065



## C55PB-PRO/8

bancada de trabalho, a combinar com mobiliário para oficina RSC55

Composição:

### C55B

Bancada de trabalho com tampo (2050x700 mm) com revestimento ABS anti-impacto e anti-riscos, resistente a óleos e hidrocarbonetos.

Equipada com:

- Furos para torno (1599F/150 - 1599GI/150, opcional)
- Pés com regulação vertical

### C55C7

Carro com 7 gavetas (588x367 mm) com guias de rolamentos de esferas

- 4 rodízios Ø 100 mm, 2 fixos e 2 giratórios (um com travão)
- Sistema de abertura em alumínio a todo o comprimento da gaveta
- Bases das gavetas com tapetes de proteção em borracha
- Fechadura frontal centralizada
- Pode ser equipado com tabuleiros flexíveis

### C55MA

Módulo fixo com 2 portas

- Sistema de abertura push-pull
- Fechadura
- Prateleira interior ajustável

### C55PS

Painel de ferramentas com persiana

- Persiana em alumínio, com regulação vertical e fechadura
- Painel de ferramentas perfurado e amovível

347 kg

C55PB-PRO/8

€ 9.200,00



1



055000066



## C55B/2

bancada de trabalho com 2 m de comprimento, para combinar com mobiliário de oficina

Bancada (2050x700 mm) com tampo revestido a PVC anti-riscos e anti-impacto, resistente a hidrocarbonetos

- Furos para fixação de torno (1599F/150 - 1599GI/150, opcional)
- Pés com regulação vertical

105 kg

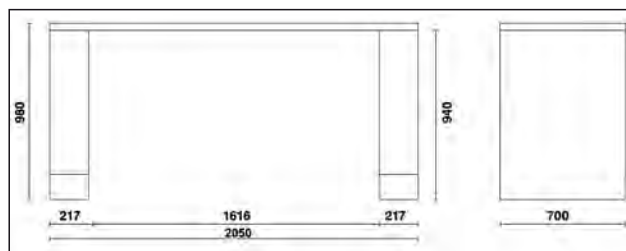

C55BO/2	€ 2.630,00	1	055000101
C55BG/2	€ 2.630,00	1	055000111

## C55PRO B/2

bancada de trabalho com 2m de comprimento, para combinar com mobiliário de oficina

Bancada (2050x700 mm) com tampo revestido a PVC anti-riscos e anti-impacto, resistente a hidrocarbonetos

Fichas e enrolador integrados:

- Tomada Schuko+16+10A
- Tomada EU +10A
- Bocal de saída do ar comprimido com enrolador, Ø 8 mm, comp.: 10 m.
- Furos para fixação de torno (1599F/150 - 1599GI/150, opcional)
- Pés com regulação vertical

110 kg

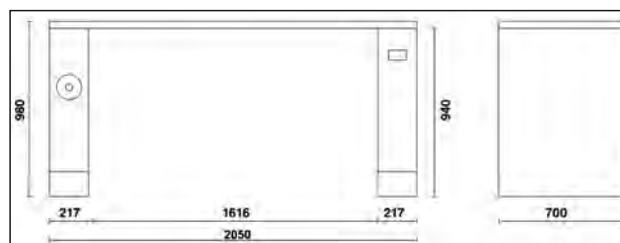
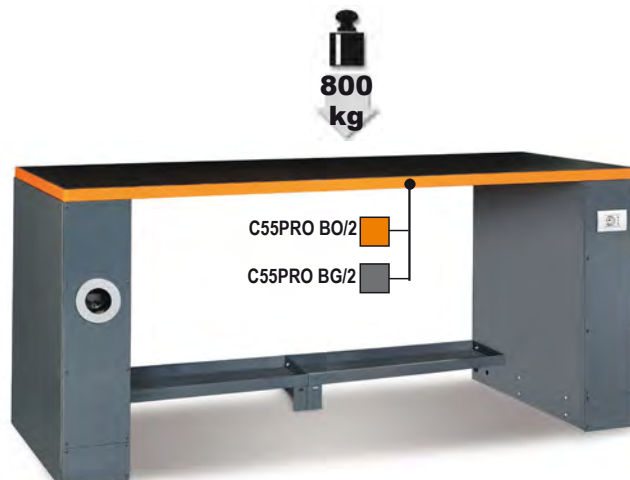

C55PRO BO/2	€ 3.210,00	1	055000151
C55PRO BG/2	€ 3.210,00	1	055000171

## C55B/2,8

bancada 2.8 m comprimento, para combinar com mobiliário de oficina

- Bancada de trabalho (2850x700 mm) com tampo revestido a PVC anti-riscos e anti-impacto, resistente a hidrocarbonetos
- Com furos para fixação do torno (1599F/150 - 1599GI/150, extra opcional)
- Pés com regulação vertical

131 kg

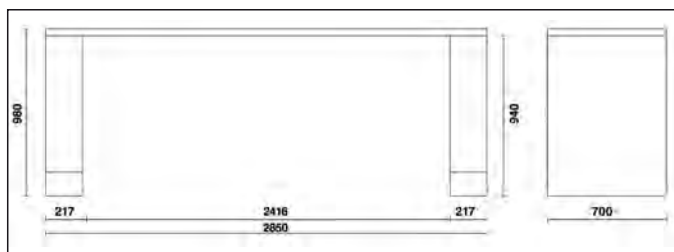
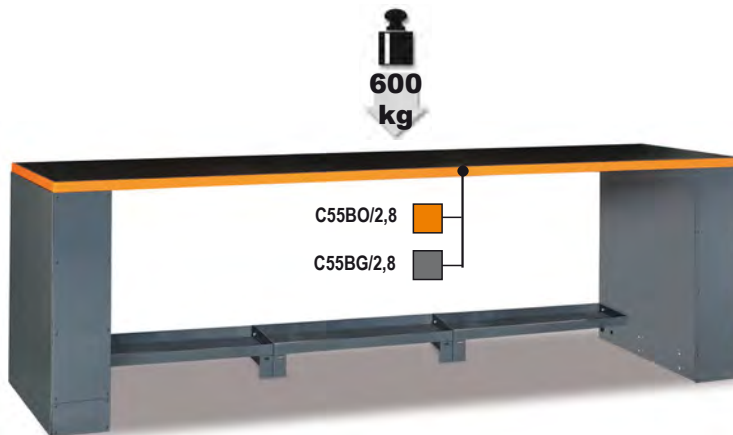

C55BO/2,8	3.300,00	1	055000261
C55BG/2,8	3.300,00	1	055000281

## C55PRO B/2,8

bancada com 2,8 m de comprimento, para combinar com mobiliário de oficina

Bancada de trabalho (2850x700) com tampo revestido a PVC anti-riscos e anti-impacto, resistente a hidrocarbonetos

Fichas e enrolador integrados:

- Tomada Schuko+16+10A
- Tomada 10A
- Bocal saída de ar comprimido com enrolador, Ø 8 mm, comp.: 10 m.
- Furos para fixação de torno (1599F/150 - 1599GI/150, opcional)
- Pés com regulação vertical

134 kg

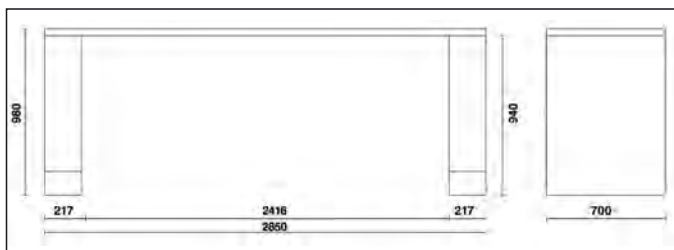
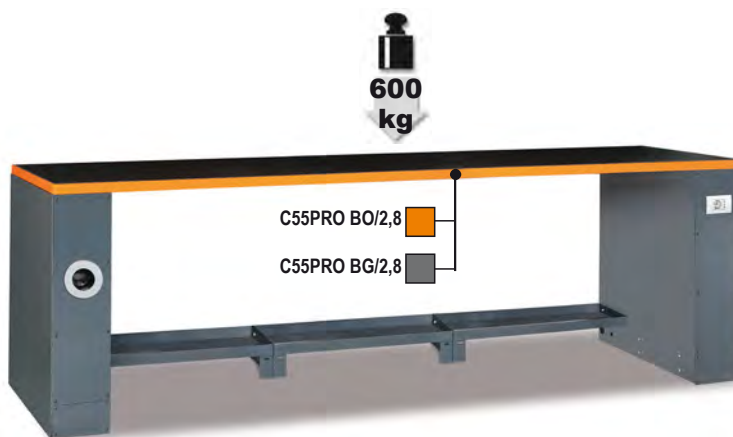

C55PRO BO/2,8	3.870,00	1	055000271
C55PRO BG/2,8	3.870,00	1	055000283



## C55B-D4

Bancada de trabalho dupla, com apoio central, 4m

Bancada de 4100x700mm revestida a PVC, resistente a choques, cortes e hidrocarbonetos. • Furos para torno 1599F/150 - 1599GI/150 (pedido à parte) • Pés com regulação de altura • Apoio central com compartimento e porta de correr de 350x700mm

185 kg

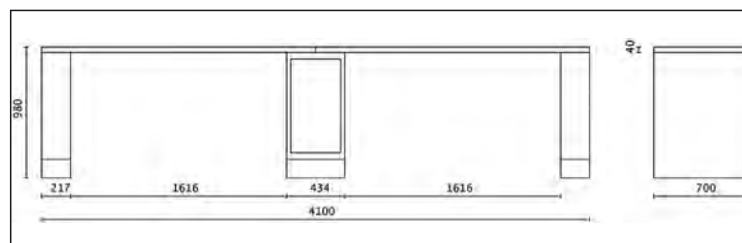
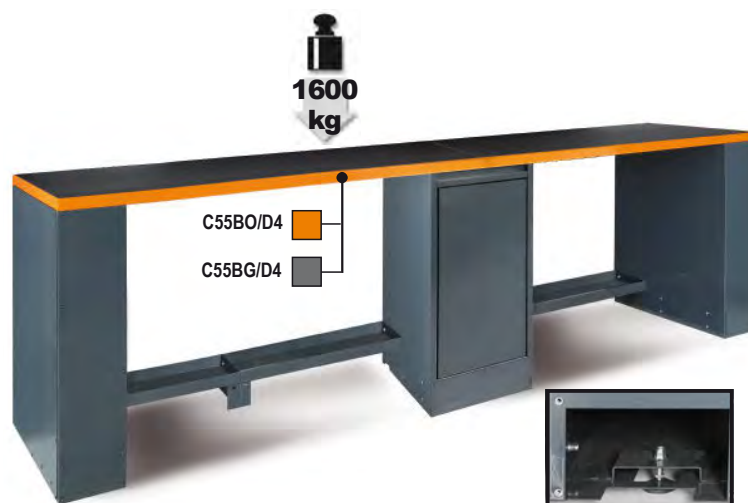

C55BO/D4	€ 5.350,00	1	055000109
C55BG/D4	€ 5.350,00	1	055000119

## C55PRO B-D4

bancada de trabalho dupla, com apoio central, 4m

Bancada de trabalho (4100x700mm) com tampo revestido a PVC anti-riscos e anti-impacto, resistente a hidrocarbonetos

Tomada e enrolador incluído:

- Tomada Schuko +16 +10A
- Tomada EU +10A
- Saída de ar comprimido com enrolador Ø 8 mm, comp.: 10 m
- Furos para fixação de torno (1599F/150 - 1599GI/150, opcional)
- Pés com regulação de altura
- Apoio central com compartimento para ferramentas e porta 365x750mm

190 kg

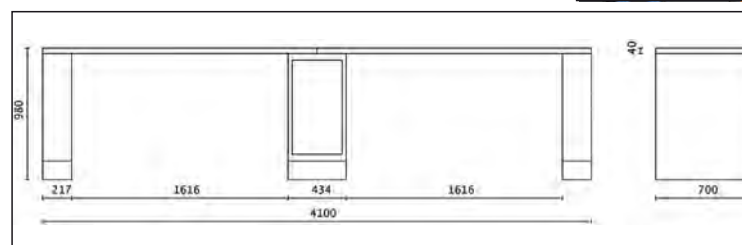
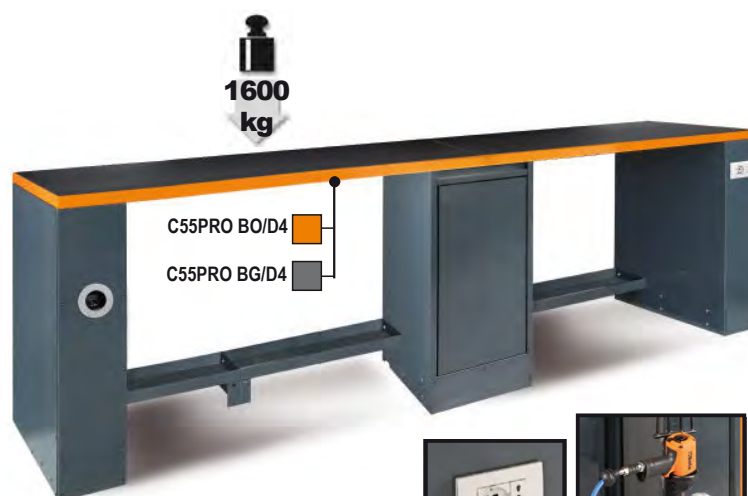

C55PRO-BO/D4	€ 5.950,00	1	055000159
C55PRO-BG/D4	€ 5.950,00	1	055000179

 **Beta**

## C55B/G

Apoio universal para bancada de oficina

- Com ajuste vertical
- Pode ser utilizado em ambos os lados da bancada de trabalho
- Abertura frontal e lateral

32 kg

C55B/G € 710,00 1 055000096

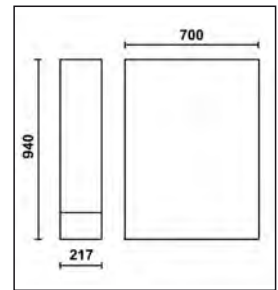

## C55B/GAA

apoio universal com enrolador de tubo para bancada de trabalho

- Enrolador de tubo automático para ar comprimido ou água fria, Ø 8 mm
- Comprimento do tubo: 10 m 1900S 8x10
- Pés com regulação vertical
- Abertura frontal e lateral

36,4 kg

C55B/GAA € 1.130,00 1 055000099

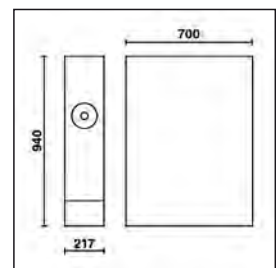
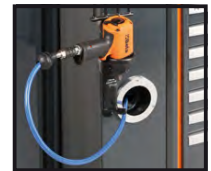

## C55B/GDP

pilar duplo para bancadas de trabalho

- Compartimento para rolo de papel
- Compartimento com porta
- Pés com regulação vertical

45 kg

C55B/GDP € 1.680,00 1 055000292

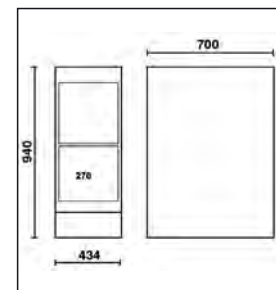

## C55B/GDS

perna dupla para bancada de trabalho adjacente

- Compartimento com porta deslizante, 365x750 mm
- Pés com regulação ajustável

45 kg

C55B/GDS € 1.510,00 1 055000291

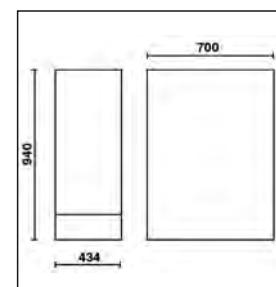

## C55B/GE

Apoio universal com tomadas para bancada de oficina

- Tomada Shuko+16+10A
- Ficha EU + 10A
- Com ajuste vertical
- Abertura frontal e lateral

30,4 kg

C55B/GE € 870,00 1 055000097

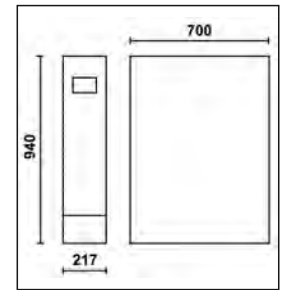

## C55B/GAE

apoio universal com enrolador de cabo elétrico para bancada de trabalho

- Enrolador de cabo elétrico automático com tomada Schuko 1844 15H05SCK
- Comprimento do cabo: 15 m
- Interruptor de proteção térmica
- Pés com ajuste vertical
- Abertura frontal e lateral

37,5 kg

C55B/GAE € 1.200,00 1 055000094

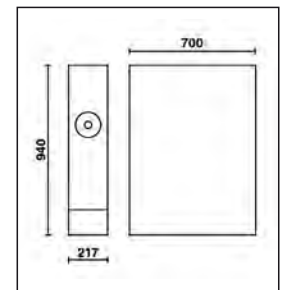
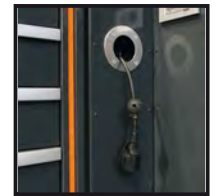



## C55/PL-1,024

plano de trabalho com 1m de comprimento

Plano de trabalho em chapa pintada (1024x700 mm) com revestimento em PVC anti-riscos e anti-impacto, resistente a hidrocarbonetos

21 kg

C55/PLO-1,024	€ 585,00	1	055000130
C55/PLG-1,024	€ 585,00	1	055000131



## C55B PT/2

bancada com 2 m de comprimento, para combinar com mobiliário de oficina

Bancada em chapa metálica pintada (2050x700 mm) com tampo revestido a PVC anti-riscos e anti-impacto, resistente a hidrocarbonetos  
Furos para fixação do torno (1599F/150 - 1599GI/150, opcional)

43 kg

C55BO PT/2	€ 1.210,00	1	055000106
C55BG PT/2	€ 1.210,00	1	055000116



## C55B PT/2,8

bancada com 2,8 m de comprimento, para combinar com mobiliário de oficina

Bancada em chapa metálica pintada (2850x700 mm) com tampo revestido a PVC anti-riscos e anti-impacto, resistente a hidrocarbonetos  
Furos para fixação do torno (1599F/150 - 1599GI/150, opcional)

67 kg

C55BO PT/2,8	€ 1.880,00	1	055000266
C55BG PT/2,8	€ 1.880,00	1	055000286



## C55RB

Revestimento em PVC resistente ao impacto e a hidrocarbonetos

Proteção de bancada de trabalho.

C55RB/2: para bancadas com 2 m de comprimento

C55RB/2.8: para bancadas com 2.8 m de comprimento

C55RB/0.7: para bancadas 700x700mm

C55RB/1: para bancadas com 1 m de comprimento

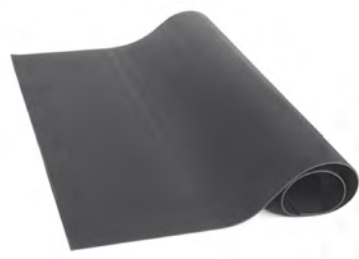

C55RB/2	€ 205,00	1	055000195
C55RB/2,8	€ 278,00	1	055000196
C55RB/0,7	€ 114,00	1	055000199
C55RB/1	€ 156,00	1	055000198

## C55B/VS

Suporte inferior para bancada de trabalho, com 0,8m de comprimento

Dimensões: 800x230x60 mm

4,2 kg

C55B/VS	€ 156,00	1	055000095
---------	----------	---	-----------

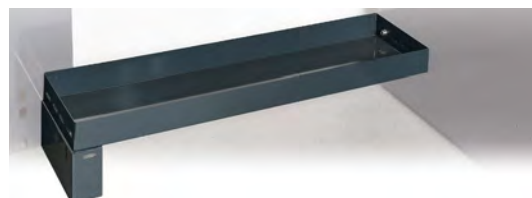

## C55C7

carro com 7 gavetas, para combinar com mobiliário de oficina

7 gavetas (588x367 mm) com calhas assentes em rolamentos de esferas

- 4 rodízios Ø 100 mm, 2 fixos (um com travão) and 2 giratórios
- Sistema de abertura em alumínio a toda a extensão da gaveta
- Gavetas protegidas com tapetes em borracha
- Fecho frontal centralizado
- Adaptável a encaixes maleáveis

79 kg



h	max
70 mm	30 kg
245 mm	40 kg

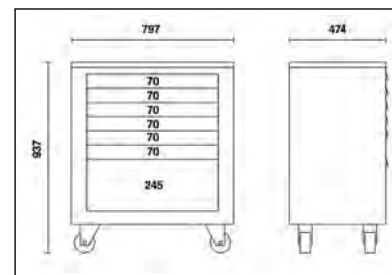
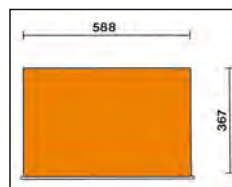

C55C7

€ 2.430,00 1 055000201

# Beta

## C55C8

carro com 8 gavetas, para combinar com mobiliário de oficina

8 gavetas (588x367 mm) com calhas assentes em rolamentos de esferas

- 4 rodízios Ø 100 mm, 2 fixos (um com travão) e 2 rotativos
- Sistema de abertura em alumínio a toda a extensão da gaveta
- Gavetas protegidas por tapetes em borracha
- Fecho frontal centralizado
- Adaptável a encaixes maleáveis

80,8 kg



h	max
70 mm	30 kg
175 mm	40 kg

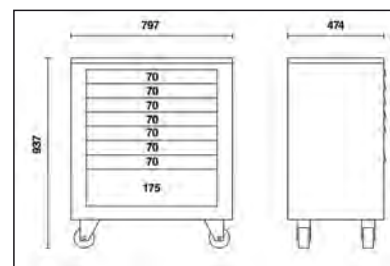
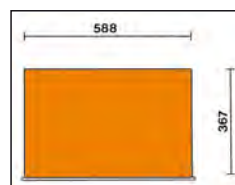

C55C8

2.470,00



1



055000206

## C55M2

módulo fixo com 2 gavetas, para combinar com mobiliário de oficina

2 gavetas (588x367mm) com calhas assentes em rolamentos de esferas

- Sistema de abertura em alumínio a toda a extensão da gaveta
- Gavetas protegidas por tapetes em borracha
- Fecho frontal centralizado

66 kg



h	max
280 mm	40 kg
385 mm	40 kg

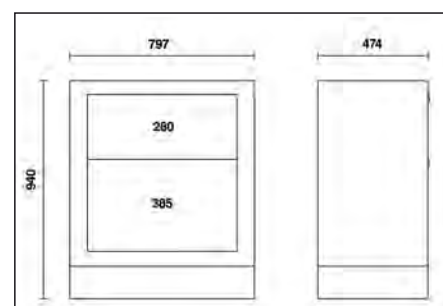
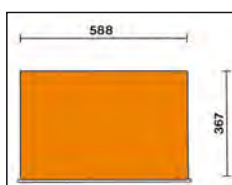

C55M2

2.070,00



1



055000202



## C55M4

Módulo fixo com 4 gavetas para combinar com mobiliário de oficina

4 gavetas (588x367) com calhas assentes em rolamentos de esferas

- Sistema de abertura em alumínio a toda a extensão da gaveta
- Base das gavetas protegida com tapetes em borracha
- Fecho frontal centralizado

75 kg

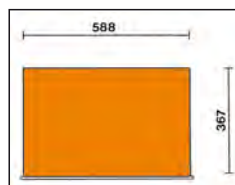

h	max
140 mm	30 kg
245 mm	40 kg

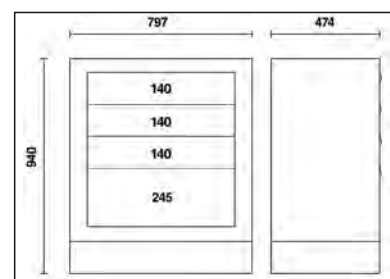

C55M4

€ 2.170,00 1 055000212

## C55M7

módulo fixo com 7 gavetas, para combinar com mobiliário de oficina

7 gavetas (588x367 mm) com calhas assentes em rolamentos de esferas

- Sistema de abertura em alumínio a toda a extensão da gaveta
- Gavetas protegidas com tapetes em borracha
- Fecho frontal centralizado
- Adaptável a encaixes maleáveis

78 kg

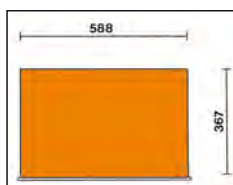

h	max
70 mm	30 kg
245 mm	40 kg

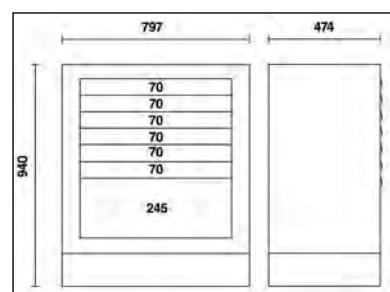

C55M7

€ 2.300,00 1 055000203

## C55M8

Módulo fixo com 8 gavetas para equipamento de oficina

8 gavetas (588x367 mm) com calhas assentes em rolamentos de esferas

- Sistema de abertura em alumínio a toda a extensão da gaveta
- Gavetas protegidas com tapetes em borracha
- Fecho frontal centralizado
- Adaptável a tabuleiros maleáveis

78,9 kg



h	max
70 mm	30 kg
175 mm	40 kg

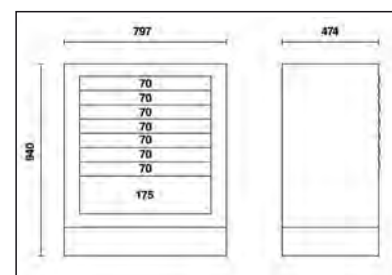
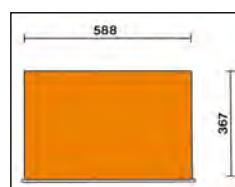

C55M8

€ 2.340,00 1 055000207

## C55CS

Módulo para resíduos diferenciados, para equipamento de oficina

- Compartimento de resíduos deslizante (588x465mm)
- 2 recipientes internos de separação de resíduos

61,4 kg

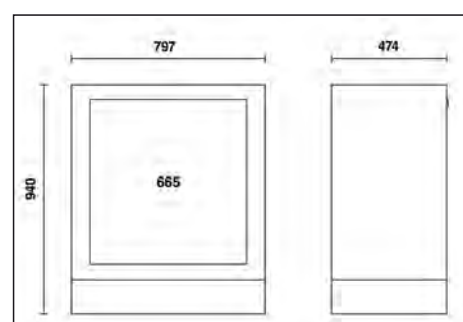

C55 CS

€ 2.090,00 1 055000208

## C55MA

módulo fixo de duas portas, para combinar com mobiliário de oficina

- Abertura push-pull
- Com fechadura • Prateleira interior, com regulação vertical

75 kg

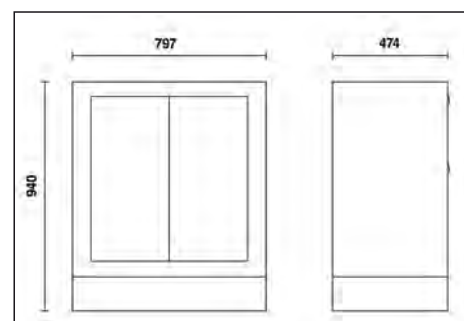

C55MA

€ 1.790,00 1 055000205

## C55MDO

Módulo fixo de distribuição de óleo para móveis de oficina

- 2 bobinas com mangueira de 7m - 1/2" incluída
- Contém 2 pistolas com contador de litro digital e coletor automático.
- Caudal máx: 30 l / min
- Viscosidade: 8 ÷ 2000 mPas

93,4 kg

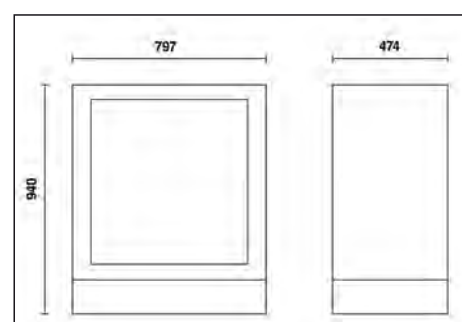

C55MDO

€ 3.620,00 1 055000210



## C55MS

módulo fixo, para combinar com mobiliário de oficina

- Caixa de lixo integrado
- Compartimento para rolo de papel perfurado
- Gaveta de arrumação, 305x270 mm

75 kg

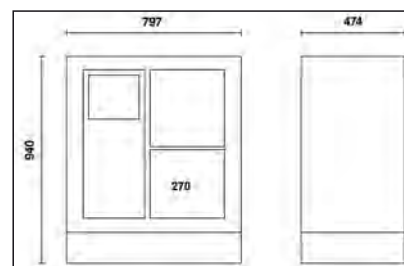

C55MS

€ 1.890,00



1



055000204

## C55T3

Carro

- 3 planos com revestimento antiderrapante em borracha rugosa
- Punho ergonómico
- 2 opções de fixação de posto de trabalho central
- 4 rodízios Ø 100 mm (2 com travões)
- Capacidade estática de carga: 200 kg (distribuída pelas 3 prateleiras)

22,8 kg

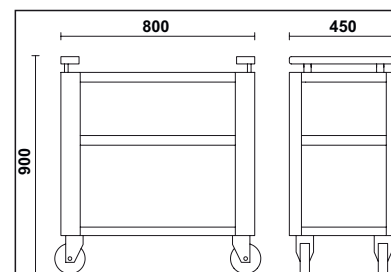

C55T3

€ 426,00



1



055000219

## C55P/MCD

Suportes centrais duplos

10 kg

C55P/MCD € 180,00 1 055000257



## C55P/2MDX-SX

Par de suportes verticais, direito/esquerdo

10 kg

C55P/2MDX-SX € 327,00 1 055000253



## C55PM

Armário suspenso com 1m de comprimento

• Dimensões: 1024x400x300 mm; com amortecedores a gás, para fácil utilização das portas.

23,4 kg

C55PM € 1.200,00 1 055000302

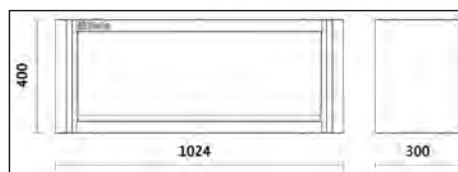

## C55PFA-1,0

Painel de ferramentas perfurado, com 1 m de comprimento, para combinar com mobiliário de oficina

Painel de ferramentas em aço perfurado (1024x1020x25 mm)

11 kg

C55PFA-1,0 € 402,00 1 055000316

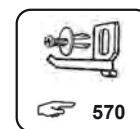
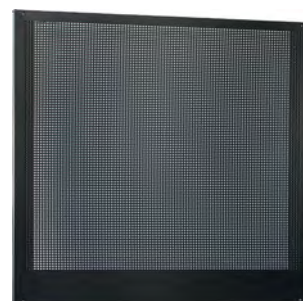

## C55/PF

Painel de ferramentas com armário, para combinar com mobiliário de oficina, com 1m de comprimento

• Painel de ferramentas (1024x600mm) compatível com C55PT 1,0 x 0,6

6 kg

C55/PF € 276,00 1 055000307

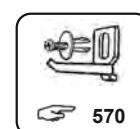
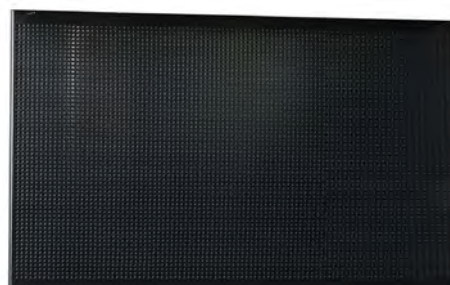

## C55PT1,0X0,6

Painel inferior do armário, com 1 m de comprimento

Dimensões: 1024x620x25 mm

8 kg

C55PT1,0X0,6 € 221,00 1 055000314



## C55PTE-1,0

Painel inferior do armário, com 1 m de comprimento

Dimensões: 1024x620x25 mm

Prevê incorporação de 2 tomadas (não incluídas)

8 kg

C55PTE-1,0 € 262,00 1 055000319



## C55/2PM

painel de ferramentas com 2 armários suspensos, para combinar com mobiliário de oficina

- 2 armários suspensos, 1024x400x300 mm, com molas pneumáticas, para fácil utilização das portas.
- Painel de ferramentas para parede, 2050x620 mm; adaptável aos painéis de ferramentas perfurados C55/PF (a encomendar separadamente)
- Fornecido com a estrutura
- Corresponde a bancada de trabalho de 2 m de comprimento

82,7 kg

C55/2PM € 3.340,00 1 055000301

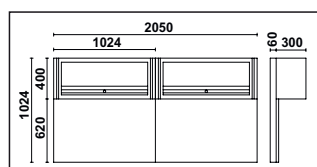
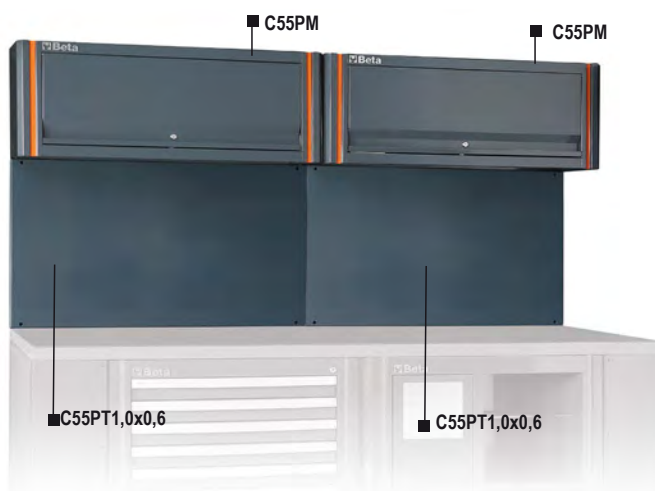



### C55PFA-0,8

Painel de ferramentas perfurado, com 0,8 m de comprimento, para combinar com mobiliário de oficina

Painel de ferramentas em aço perfurado (800x1020x25 mm)

10 kg

C55PFA-0,8 € 370,00 1 055000315

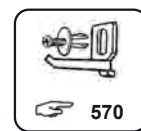

### C55PM/M0,8

Armário suspenso com 0,8m de comprimento, para combinar com mobiliário de oficina

Dimensões: 800x400x300 mm; com molas pneumáticas para facilitar a abertura das portas.

19 kg

C55PM/M0,8 € 1.150,00 1 055000312

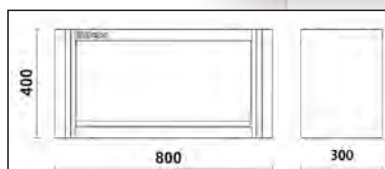

### C55PTE-0,8

Painel inferior do armário, com 0,8 m de comprimento

Dimensões: 800x620x25 mm

Prevê incorporação de 1 Tomada (não incluída)

6 kg

C55PTE-0,8 € 238,00 1 055000318



### C55PT0,8X0,6

Painel inferior do armário, com 0,8 m de comprimento

Dimensões: 800x620x25 mm

7,8 kg

C55PT0,8X0,6 € 205,00 1 055000313



### C55/1PF

painel perfurado para ferramentas, a combinar com mobiliário de oficina

• Painel perfurado para ferramentas (800x600 mm)

4,6 kg

C55/1PF € 172,00 1 055000309

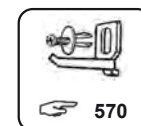
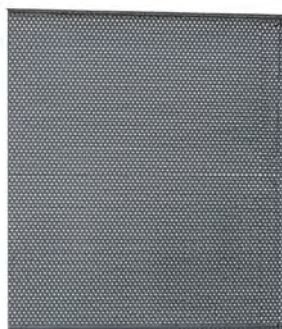

## C55PS

painel para ferramentas com persiana, para combinar com mobiliário de oficina

- Persiana em alumínio, com regulação vertical e fechadura
- Painel de ferramentas perfurado e amovível
- Fornecido com estrutura
- Kit de 50 ganchos GPS incluídos
- Corresponde a bancada de trabalho de 2 m de comprimento

85,7 kg

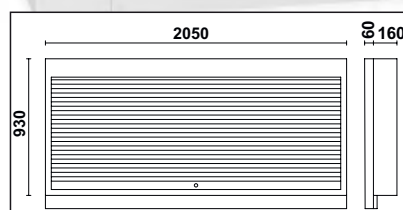

C55PS-O	2.490,00	1	055000250
C55PS-G	2.490,00	1	055000255

## C55PSE

Painel para ferramentas com persiana, com 2 tomadas

- Persiana em alumínio, com regulação vertical e fechadura
- Painel de ferramentas perfurado e amovível
- Fornecido com estrutura
- Kit de 50 ganchos GPS incluídos
- Tomadas incluídas
- Bancada de trabalho com 2m de comprimento

85,7 kg

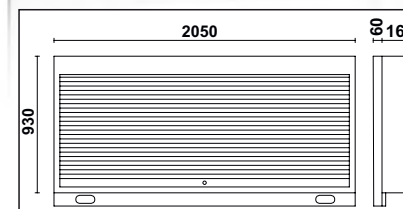

C55PSE-O	2.520,00	1	055000258
C55PSE-G	2.520,00	1	055000260

## C55AE

Perfil de apoio com tomadas, com 2 m de comprimento

Dimensões: 2050x25x90mm  
2 Tomadas

3 kg



C55AE	221,00	1	055000325
-------	--------	---	-----------

## C55AC

ângulo de apoio

Bancada com pés de apoio (700x700)

2 sistemas de parede de ferramentas com 2 prateleiras de fixação (670x160mm)

63 kg

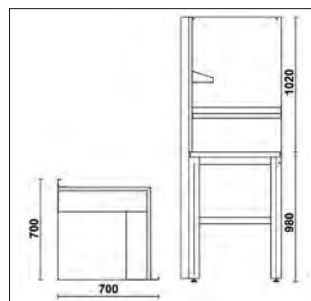

C55AC-O

C55AC-G

C55AC-O	€ 2.740,00	1	055000360
C55AC-G	€ 2.740,00	1	055000380

## C55KAI

Canto para bancada 700x700, com apoio para combinar com mobiliário de oficina

• Tampo em chapa pintada (700x700mm) com revestimento em PVC resistente ao impacto e hidrocarbonetos

33 kg

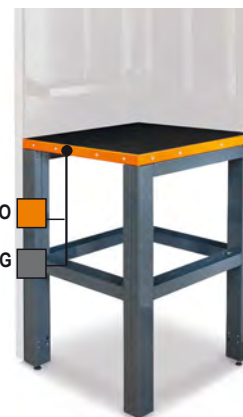

C55KAI-O

C55KAI-G

C55KAI-O	€ 1.570,00	1	055000365
C55KAI-G	€ 1.570,00	1	055000385

## C55MP

prateleiras em aço para cantos

Dimensões: 700x160x80 mm

3 kg



C55MP	€ 164,00	1	055000374
-------	----------	---	-----------

# Beta



## C55A1

armário para ferramentas em chapa metálica com uma porta, a combinar com mobiliário de oficina RSC55

- 3 prateleiras amovíveis com regulação vertical
- varão para vestuário sob a primeira prateleira
- com fechadura
- dimensões anteriores: 1770x420x420 mm

47,3 kg

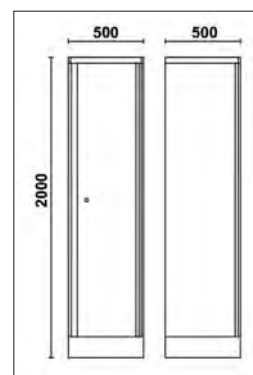
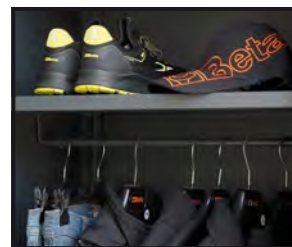

C55A1

€ 870,00 1 055000411

## C55A1/R42

prateleira interior para armário de ferramentas C55A1/C55AT1

1,9 kg



C55A1/R42

497x403 mm

€ 37,50 1 055000461

## C55 A1/RB42

prateleira interior para armário C55A1/C55AT1, com varão para vestuário

2,3 kg

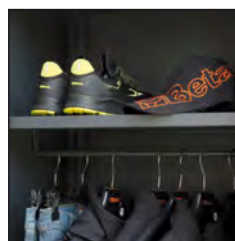

C55 A1/RB42

mm 497x403

€ 47,00 1 055000463



# Beta



## C55A2

armário para ferramentas em chapa metálica com duas portas, a combinar com mobiliário de oficina

- 3 prateleiras amovíveis com regulação vertical
- Com fechadura
- Dimensões interiores (úteis): 1798x797x403 mm

69,5 kg

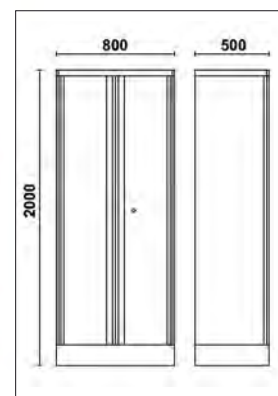

C55A2 € 1.170,00 1 055000412

## C55A2/R70

prateleira interior para armário de ferramentas C55A2/C55AT2

3,6 kg

50 kg



C55A2/R70 700x420 mm € 60,50 1 055000462

# Beta

## C55AT1

armário para ferramentas em chapa metálica com duas portas em policarbonato transparente, para combinar com mobiliário modular de oficina

- 3 prateleiras amovíveis e de altura ajustável
- Com fechadura
- Dimensões espaço útil interior: 1798x497x403 mm

41 kg

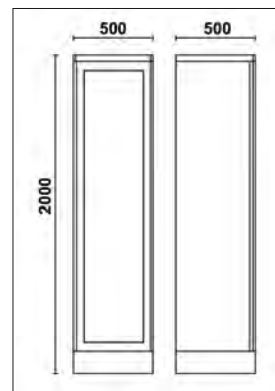

C55AT1 € 970,00 1 055000421

## C55AT2

armário para ferramentas em chapa metálica com duas portas em policarbonato transparente, para combinar com mobiliário modular de oficina

- 3 prateleiras amovíveis e de altura ajustável
- Com fechadura
- Dimensões espaço útil interior: 1798x797x403 mm

56 kg

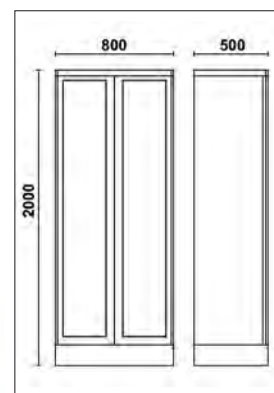

C55AT2 € 1.310,00 1 055000422

## C55STR

fita adesiva 25 m

permite adaptar as fitas verticais do mobiliário de garagem ref. C55



RAL2011  
RAL3000  
RAL6029  
RAL9016  
RAL1023  
RAL5015  
RAL1035  
RAL9006

	€		
C55STR-O/2011	88,50	1	055000901
C55STR-R/3000	88,50	1	055000903
C55STR-V/6029	88,50	1	055000906
C55STR-Y/1023	88,50	1	055000905
C55STR-B/5015	88,50	1	055000904
C55STR-S/9006	88,50	1	055000902







# MOBILIÁRIO PARA OFICINA RSC50 2.0



A Beta continua a evoluir de acordo com as tendências do mercado, para enfrentar com sucesso os desafios do futuro. Como resultado, o mobiliário modular para oficina, RSC50, foi atualizado para o **novo e revolucionário sistema, RSC50 2.0**. A nova **bancada de 70 cm de comprimento**, os três tipos de materiais à escolha (chapa, madeira laminada e MDF revestido **a aço inoxidável**) fazem do RSC50 2.0 uma gama ITALIANA única. RSC50 2.0 significa uma combinação perfeita de design moderno e funcionalidade incomparável. Concebido para satisfazer as necessidades dos profissionais atuais.

 **Beta**  
RSC50 2.0



## QUALIDADE

O nosso cuidado na escolha dos materiais, atenção meticulosa aos detalhes e o design atraente fazem do RSC50 2.0 uma linha única de mobiliário de oficina.



## FUNCIONALIDADE E RESISTÊNCIA

O plano de trabalho com 70 cm de profundidade resultam numa superfície prática e funcional, de grandes dimensões. Pode ser equipado com um torno, permitindo assim a realização de trabalhos pesados.



## EFICIÊNCIA

Instalação simples e rápida, graças à otimização das várias peças da gama.



## FLEXIBILIDADE

Instalação simples e rápida, graças à otimização das várias peças da gama.



## COMPATIBILIDADE

As gavetas nas dimensões standard da Beta (588x367 mm) podem acomodar os vários módulos de ferramentas, disponíveis nas versões maleável e rígida, em EVA e ABS, respetivamente.

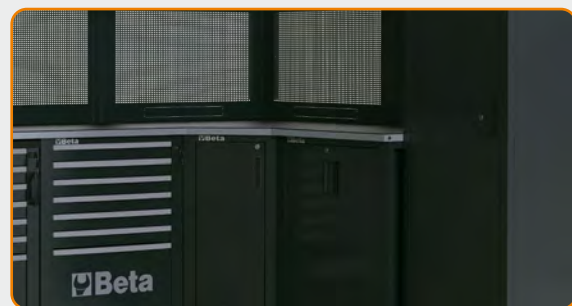
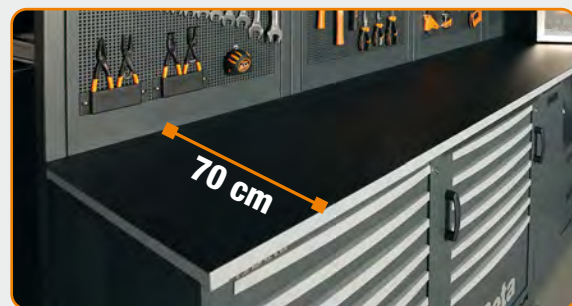





# MOBILIÁRIO PARA OFICINA RSC50 2.0



Configure a sua oficina  
em 3D online em  
[www.beta-tools.com/rsc50](http://www.beta-tools.com/rsc50)

A gama de mobiliário para oficina, RSC50 2.0, é composta por combinações pré-montadas, desenvolvidas pela Beta para profissionais, em alternativa, pode projetar o seu próprio local de trabalho, escolhendo entre vários módulos de bancada, armários de parede e acessórios de decoração.

**Escolha o sistema RSC50 2.0 e saiba como a Beta continua a revolucionar o mundo dos equipamentos de oficina com soluções que fazem a diferença!**

## RSC50 2.0 I

combinação de mobiliário modular para oficina, RSC50 2.0

Combinação composta por:

- 1 bancada de 2240x700 mm (RSC50 2.0 NPG//3-2,2MT)
- 1 bancada de 1495x700 mm (RSC50 2.0 NPG/2-1,5MT)
- 1 módulo fixo com 7 gavetas (RSC50 2.0 M7)
- 1 carro de ferramentas com 7 gavetas (RSC50 2.0 C7)
- 1 módulo de serviço fixo com 2 gavetas (RSC50 2.0 MS-2C)
- 1 canto completo independente (RSC50 2.0 NAC-G)
- 1 módulo fixo com 5 gavetas (RSC50 2.0 M5)
- 1 módulo fixo de duas portas (RSC50 2.0 MA)
- 5 armários suspensos (RSC50 2.0 PM)
- 5 painéis de ferramentas perfurados superiores (RSC50 2.0 PFS)
- 5 painéis de ferramentas perfurados inferiores (RSC50 2.0 PFI)
- 5 pares de suportes verticais direitos/esquerdos (RSC50 2.0 P/2MDX-SX)
- 2 armários de uma porta (RSC50 2.0 A1)

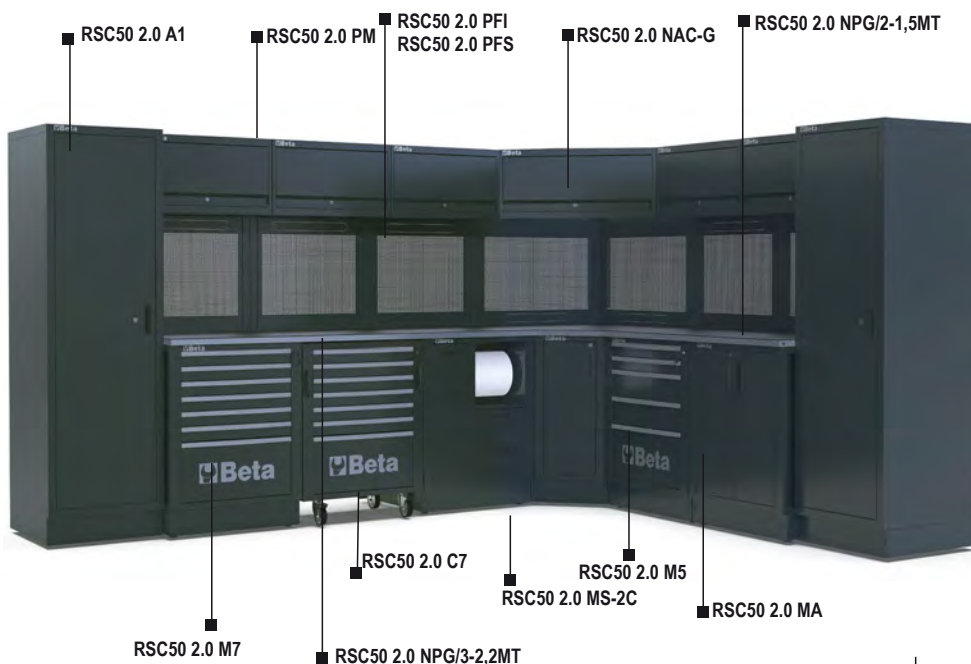

804 kg

RSC50 2.0 I 23.900,00 € 1 050001046

## RSC50 2.0 L

combinação de mobiliário modular para oficina, RSC50 2.0

Combinação composta por:

- 1 bancada de 2240x700 mm (RSC50 2.0 NPG/3-2,2MT)
- 1 bancada de 750x700 mm (RSC50 2.0 NPG/1-0,7MT)
- 1 módulo de serviço fixo (RSC50 2.0 MS-2AVV) com enrolador para tubo de ar comprimido artigo 1900S 8x10 e enrolador de cabo elétrico artigo 1844 15-H05/SCK (incluído)
- 1 carro de ferramentas com 7 gavetas (RSC50 2.0 C7)
- 1 módulo fixo com 7 gavetas (RSC50 2.0 M7)
- 1 canto completo independente (RSC50 2.0 NAC-G)
- 1 módulo fixo de duas portas (RSC50 2.0 MA)
- 1 painel para ferramentas com persiana e estrutura em alumínio (RSC50 2.0 PS)
- 2 armários suspensos (RSC50 2.0 PM)
- 2 painéis de ferramentas perfurados superiores (RSC50 2.0 PFS)
- 2 painéis de ferramentas perfurados inferiores (RSC50 2.0 PFI)
- 2 pares de suportes verticais direito/esquerdo (RSC50 2.0 P/2MDX-SX)
- 2 armários de ferramentas de uma porta (RSC50 2.0 A1)

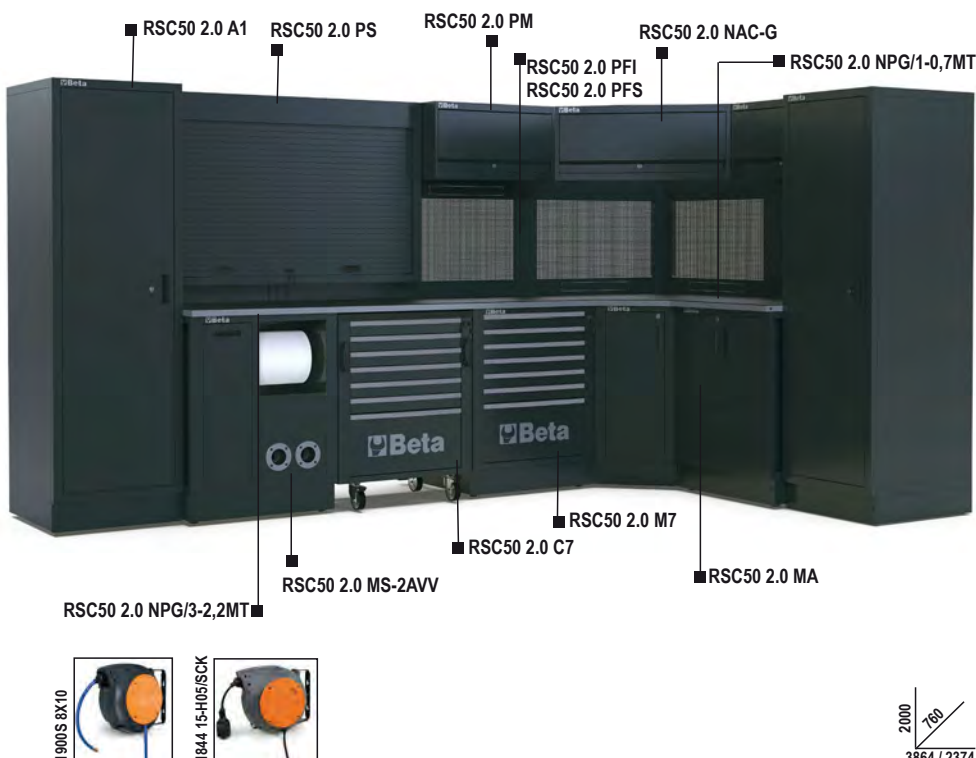

720 kg

RSC50 2.0 L 21.300,00 € 1 050001051



## RSC50 2.0

combinação de mobiliário modular para oficina, RSC50 2.0

Combinação composta por:

- 1 armário de ferramentas de uma porta (RSC50 2.0 A1)
- 1 bancada de 750x700 mm (RSC50 2.0 NPG/1-0,7MT)
- 1 bancada de 2240x700 mm (RSC50 2.0 NPG/3-2,2MT)
- 1 carro de ferramentas com 7 gavetas (RSC50 2.0 C7)
- 1 módulo fixo com 4 gavetas (RSC50 2.0 M4)
- 1 módulo fixo com 7 gavetas (RSC50 2.0 M7)
- 1 módulo de serviço fixo (RSC50 2.0 MS-AVV) com enrolador para tubo de ar comprimido artigo 1900S 8x10 (incluído)
- 1 armário suspenso com persiana e estrutura em alumínio (RSC50 2.0 PS)
- 2 armários suspensos (RSC50 2.0 PM)
- 2 painéis de ferramentas perfurados superiores (RSC50 2.0 PFS)
- 2 painéis de ferramentas perfurados inferiores (RSC50 2.0 PFI)
- 2 pares de suportes verticais direito/esquerdo (RSC50 2.0 P/2MDX-SX)
- 1 armário de ferramentas de duas portas (RSC50 2.0 A2)

604 kg

RSC50 2.0 € 16.400,00 1 050001001

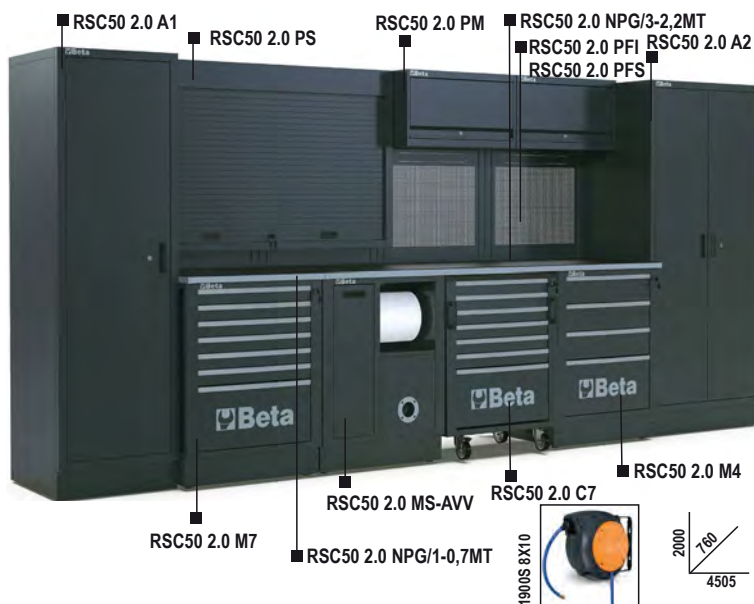

## RSC50 2.0 H

combinação de mobiliário modular para oficina, RSC50 2.0

Combinação composta por:

- 1 bancada de 2240x700 mm (RSC50 2.0 NPG//3-2,2MT)
- 1 módulo de serviço fixo com 2 gavetas (RSC50 2.0 MS-2C)
- 1 carro de ferramentas com 7 gavetas (RSC50 2.0 C7)
- 1 módulo fixo com 7 gavetas (RSC50 2.0 M7)
- 1 módulo fixo com lavatório (RSC50 2.0 ML)
- 4 armários suspensos (RSC50 2.0 PM)
- 4 painéis de ferramentas perfurados superiores (RSC50 2.0 PFS)
- 4 painéis de ferramentas perfurados inferiores (RSC50 2.0 PFI)
- 4 pares de suportes verticais direito/esquerdo (RSC50 2.0 P/2MDX-SX)
- 1 armário de ferramentas de uma porta (RSC50 2.0 A1)

464 kg

RSC50 2.0 H € 14.300,00 1 050001041

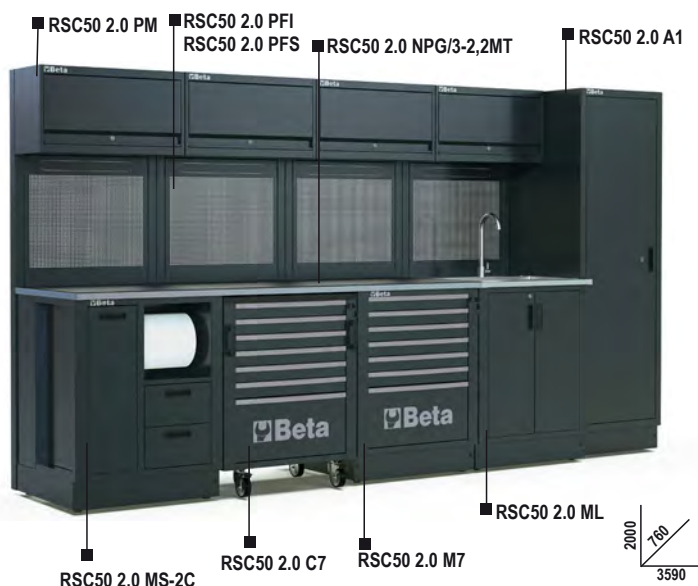

## RSC50 2.0 G

combinação de mobiliário modular para oficina, RSC50 2.0

Combinação composta por:

- 1 bancada de 2240x700 mm (RSC50 2.0 NPG/3-3,2MT)
- 1 módulo de serviço fixo (RSC50 2.0 MS-2AVV) com enrolador para tubo de ar comprimido, artigo 1900S 8x10 e enrolador de cabo elétrico artigo 1844 15-H05/SCK (incluído)
- 1 carro de ferramentas com 7 gavetas (RSC50 2.0 C7)
- 1 módulo fixo com 4 gavetas (RSC50 2.0 M4)
- 3 armários suspensos (RSC50 2.0 PM)
- 3 painéis de ferramentas perfurados superiores (RSC50 2.0 PFS)
- 3 painéis de ferramentas perfurados inferiores (RSC50 2.0 PFI)
- 3 pares de suportes verticais direito/esquerdo (RSC50 2.0 P/2MDX-SX)
- 1 armário de ferramentas de duas portas (RSC50 2.0 A2)

416 kg

RSC50 2.0 G € 12.100,00 1 050001036



## RSC50 2.0 F

combinação de mobiliário modular para oficina, RSC50 2.0

Combinação composta por:

- 1 bancada de 2240x700 mm (RSC50 2.0 NPG/3-2,2MT)
- 1 módulo fixo com 7 gavetas (RSC50 2.0 M7)
- 1 carro de ferramentas com 7 gavetas (RSC50 2.0 C7)
- 1 módulo de serviço fixo com 2 gavetas (RSC50 2.0 MS-2C)
- 3 armários suspensos (RSC50 2.0 PM)
- 3 painéis de ferramentas perfurados superiores (RSC50 2.0 PFS)
- 3 painéis de ferramentas perfurados inferiores (RSC50 2.0 PFI)
- 3 pares de suportes verticais direito/esquerdo (RSC50 2.0 P/2MDX-SX)
- 1 armário duas portas (RSC50 2.0 A2)

411 kg

RSC50 2.0 F

11.900,00

1

050001031

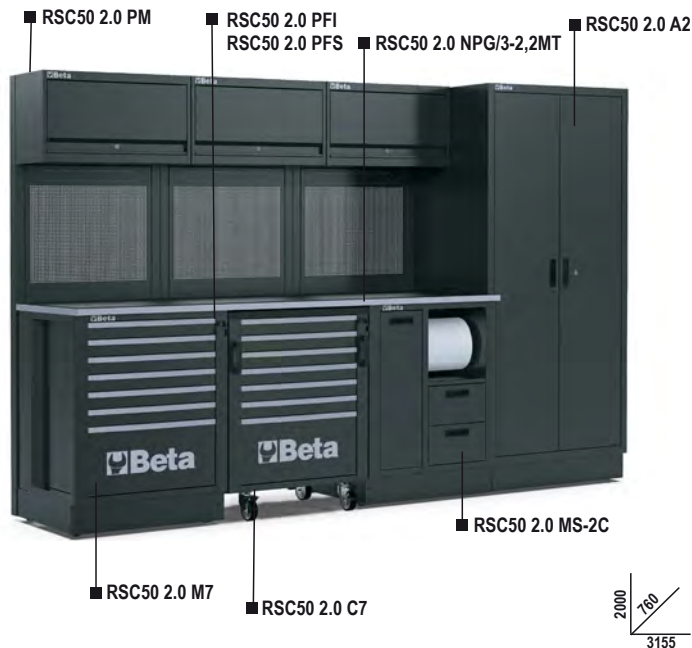

## RSC50 2.0 FX

combinação de mobiliário modular para oficina RSC50 2.0

Combinação inclui:

- 1 plano de trabalho (2240x700 mm) em MDF revestido a aço inox (RSC50 2.0 PX/3-2. 2MT)
- 1 módulo fixo com 7 gavetas (RSC50 2.0 M7)
- 1 carro de ferramentas com 7 gavetas (RSC50 2.0 C7)
- 1 módulo de serviço fixo com 2 gavetas (RSC50 2.0 MS-2C)
- 3 armários de parede (RSC50 2.0 PM)
- 3 painéis de ferramentas perfurados superiores (RSC50 2.0 PFS)
- 3 painéis de ferramentas perfurados inferiores (RSC50 2.0 PFI)
- 3 pares de suportes direito/esquerdo (RSC50 2.0 P/2MDX-SX)
- 1 armário de ferramentas de duas portas (RSC50 2.0 A2)

405 kg

RSC50 2.0 FX

11.500,00

1

050001032



## RSC50 2.0 FW

combinação de mobiliário modular para oficina RSC50 2.0

Combinação inclui:

- 1 plano de trabalho (2240x700 mm) em madeira laminada (RSC50 2.0 PW/3-2. 2MT)
- 1 módulo fixo com 7 gavetas (RSC50 2.0 M7)
- 1 carro de ferramentas com 7 gavetas (RSC50 2.0 C7)
- 1 módulo de serviço fixo com 2 gavetas (RSC50 2.0 MS-2C)
- 3 armários de parede (RSC50 2.0 PM)
- 3 painéis de ferramentas perfurados superiores (RSC50 2.0 PFS)
- 3 painéis de ferramentas perfurados inferiores (RSC50 2.0 PFI)
- 3 pares de suportes direito/esquerdo (RSC50 2.0 P/2MDX-SX)
- 1 armário de ferramentas de duas portas (RSC50 2.0 A2)

386 kg

RSC50 2.0 FW

11.300,00

1

050001033

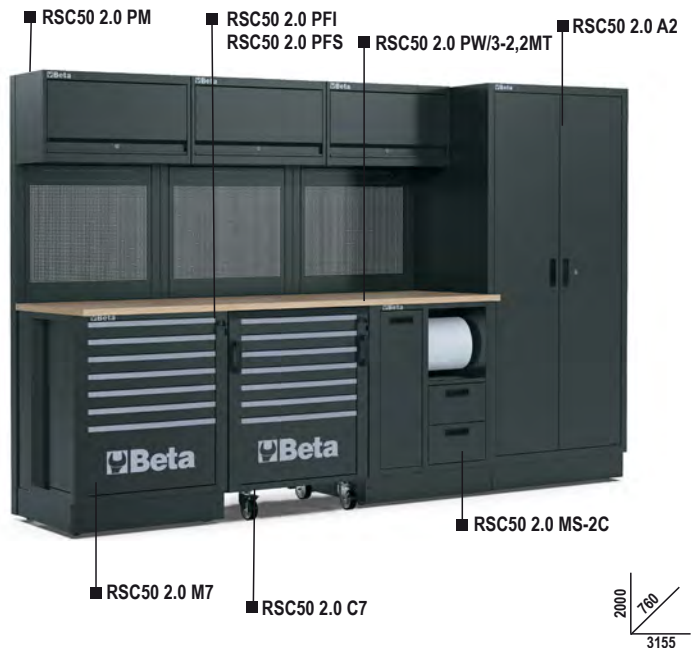

## RSC50 2.0 E

combinação de mobiliário modular para oficina, RSC50 2.0

Combinação composta por:

- 1 bancada de 2240x700 mm (RSC50 2.0 NPG/3-2,2MT)
- 1 módulo de serviço fixo com 2 gavetas (RSC50 2.0 MS-2C)
- 1 módulo fixo com 7 gavetas (RSC50 2.0 M7)
- 1 módulo fixo de duas portas (RSC50 2.0 MA)
- 3 armários suspensos (RSC50 2.0 PM)
- 3 painéis de ferramentas perfurados superiores (RSC50 2.0 PFS)
- 3 painéis de ferramentas perfurados inferiores (RSC50 2.0 PFI)
- 3 pares de suportes verticais direito/esquerdo (RSC50 2.0 P/2MDX-SX)

310 kg

RSC50 2.0 E

€ 9.750,00



1 050001026



## RSC50 2.0 D

combinação de mobiliário modular para oficina, RSC50 2.0

Combinação composta por:

- 1 bancada de 1495x700 mm (RSC50 2.0 NPG/2-1,5MT)
- 1 módulo fixo com 7 gavetas (RSC50 2.0 M7)
- 1 módulo fixo de duas portas (RSC50 2.0 MA)
- 2 armários suspensos (RSC50 2.0 PM)
- 2 painéis de ferramentas perfurados superiores (RSC50 2.0 PFS)
- 2 painéis de ferramentas perfurados inferiores (RSC50 2.0 PFI)
- 2 pares de suportes verticais direito/esquerdo (RSC50 2.0 P/2MDX-SX)
- 1 armário de ferramentas de uma porta (RSC50 2.0 A1)

276 kg

RSC50 2.0 D

€ 7.450,00



1 050001021

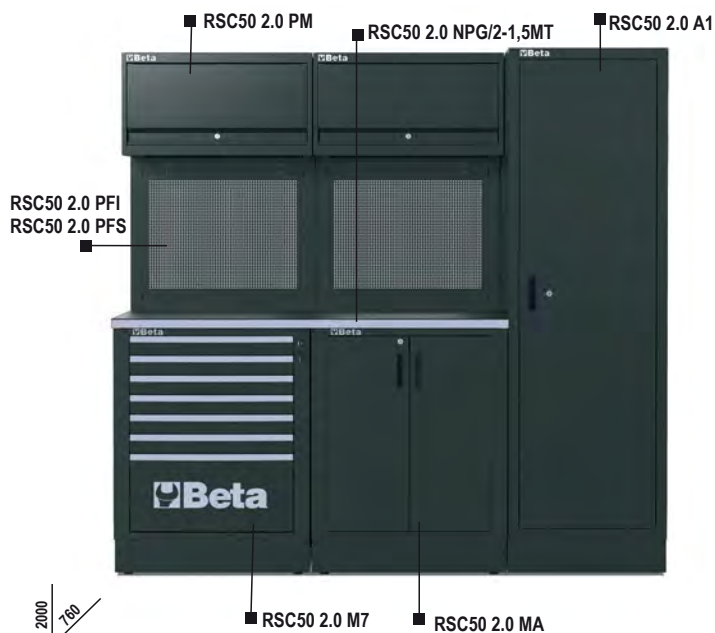

## RSC50 2.0 DX

combinação de mobiliário modular para oficina RSC50 2.0

Combinação inclui:

- 1 plano de trabalho (1495x700 mm) em MDF revestido a aço inox (RSC50 2.0 PX/2-1.5MT)
- 1 módulo fixo com 7 gavetas (RSC50 2.0 M7)
- 1 módulo fixo de duas portas (RSC50 2.0 MA)
- 2 armários de parede (RSC50 2.0 PM)
- 2 painéis de ferramentas perfurados superiores (RSC50 2.0 PFS)
- 2 painéis de ferramentas perfurados inferiores (RSC50 2.0 PFI)
- 2 pares de suportes direito/esquerdo (RSC50 2.0 P/2MDX-SX)
- 1 armário de ferramentas de uma porta (RSC50 2.0 A1)

275 kg

RSC50 2.0 DX

€ 7.200,00



1 050001023





## RSC50 2.0 DW

combinação de mobiliário modular para oficina RSC50 2.0

Combinação inclui:

- 1 plano de trabalho (1495x700 mm) em madeira laminada (RSC50 2.0 PW/2-1.5MT)
- 1 módulo fixo com 7 gavetas (RSC50 2.0 M7)
- 1 módulo fixo de duas portas (RSC50 2.0 MA)
- 2 armários de parede (RSC50 2.0 PM)
- 2 painéis de ferramentas perfurados superiores (RSC50 2.0 PFS)
- 2 painéis de ferramentas perfurados inferiores (RSC50 2.0 PFI)
- 2 pares de suportes direito/esquerdo (RSC50 2.0 P/2MDX-SX)
- 1 armário de ferramentas de uma porta (RSC50 2.0 A1)

263 kg

RSC50 2.0 DW

€ 7.050,00 1 050001024



## RSC50 2.0 C

combinação de mobiliário modular para oficina, RSC50 2.0

Combinação composta por:

- 1 bancada de trabalho de 1495x700 mm (RSC50 2.0 NPG/2-1,5MT)
- 1 módulo de serviço fixo com 2 gavetas (RSC50 2.0 MS-2C)
- 1 módulo fixo com 7 gavetas (RSC50 2.0 M7)
- 2 armários suspensos (RSC50 2.0 PM)
- 2 painéis de ferramentas perfurados superiores (RSC50 2.0 PFS)
- 2 painéis de ferramentas perfurados inferiores (RSC50 2.0 PFI)
- 2 pares de suportes verticais direito/esquerdo (RSC50 2.0 P/2MDX-SX)
- 1 armário de ferramentas de uma porta (RSC50 2.0 A1)

279 kg

RSC50 2.0 C

€ 7.750,00 1 050001016

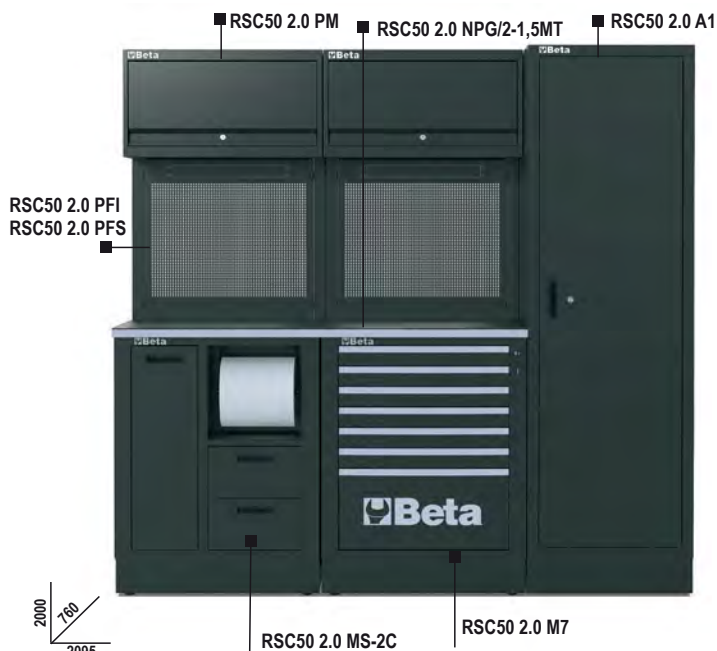

## RSC50 2.0 B

combinação de mobiliário modular para oficina RSC50 2.0

Combinação composta por:

- 1 bancada de trabalho de 1495x700 mm (RSC50 2.0 NPG/2-1,5MT)
- 1 módulo fixo de duas portas (RSC50 2.0 MA)
- 1 módulo fixo com 7 gavetas (RSC50 2.0 M7)
- 1 armário suspenso com persiana e estrutura em alumínio (RSC50 2.0 PS)

224 kg

RSC50 2.0 B

€ 6.700,00 1 050001011



## RSC50 2.0 A

combinação de mobiliário modular para oficina, RSC50 2.0

Combinação composta por:

- 1 bancada de 1495x700 mm (RSC50 2.0 NPG/2-1,5MT)
- 1 módulo fixo com 7 gavetas (RSC50 2.0 M7)
- 1 módulo de serviço fixo com 2 gavetas (RSC50 2.0 MS-2C)
- 2 armários suspensos (RSC50 2.0 PM)
- 2 painéis de ferramentas perfurados superiores (RSC50 2.0 PFS)
- 2 painéis de ferramentas perfurados inferiores (RSC50 2.0 PFI)
- 2 pares de suportes verticais direito/esquerdo (RSC50 2.0 P/2MDX-SX)

212 kg

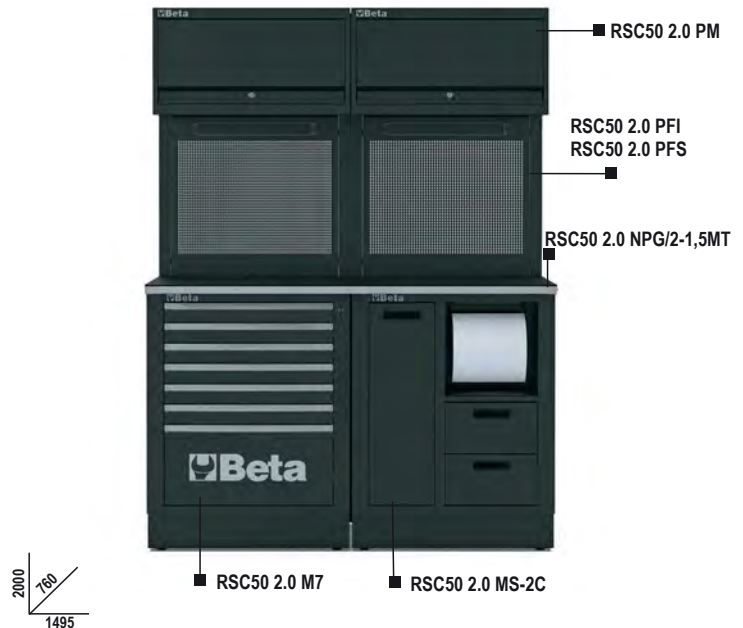

RSC50 2.0 A 6.800,00 € 1 050001006

## RSC50 2.0 NP/1-0,7MT

plano de trabalho em chapa, 0,75 m de comprimento, para bancada de trabalho, para combinar com mobiliário de oficina RSC50 2.0

Plano de trabalho (750x700 mm) em chapa pintada, com revestimento em PVC anti-impacto e anti-riscos resistente a hidrocarbonetos.

Fornecido com dois apoios laterais.

Orifícios em ambos os lados para fixação de torno (1599P/125, opcional). Permite a aplicação de perfis de alumínio com fita LED artigo 5000 RSC50 2.0/PLEDC ou 5000 RSC50 2.0/PLED-ST (opcional), para iluminação dos módulos de bancada inferiores.

16,7 kg

RSC50 2.0 NPA/1-0,7MT 585,00 € 1 050001117  
RSC50 2.0 NPG/1-0,7MT 600,00 € 1 050001118

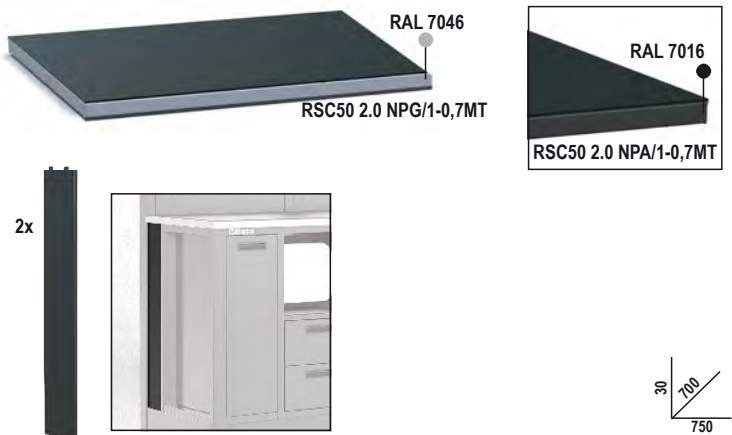

## RSC50 2.0 NP/2-1,5MT

plano de trabalho em chapa, 1,5 m de comprimento, para bancada de trabalho, para combinar com mobiliário de oficina RSC50 2.0

Plano de trabalho (1495x700 mm) em chapa pintada, com revestimento em PVC anti-impacto e anti-riscos, resistente a hidrocarbonetos. Fornecido com dois apoios laterais.

Orifícios em ambos os lados para fixação de torno (1599P/125, opcional). Permite a aplicação de perfis de alumínio com fita LED 5000 RSC50 2.0/PLEDC ou 5000 RSC50 2.0/PLED-ST (opcional), para a iluminação dos módulos de bancada inferiores.

31 kg

RSC50 2.0 NPA/2-1,5MT 805,00 € 1 050001124  
RSC50 2.0 NPG/2-1,5MT 805,00 € 1 050001125

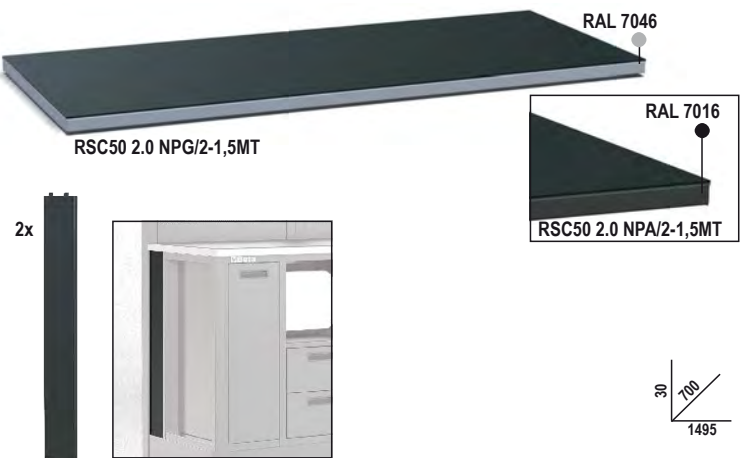

## RSC50 2.0 NP/3-2,2MT

plano de trabalho em chapa, 2,2 m de comprimento, para bancada de trabalho, para combinar com mobiliário de oficina RSC50 2.0

Plano de trabalho (2240x700 mm) em chapa pintada, com revestimento em PVC resistente aos choques e aos riscos, resistente a hidrocarbonetos. Fornecido com dois apoios laterais.

Orifícios em ambos os lados para fixação de torno (1599P/125, opcional). Permite a aplicação de perfis de alumínio com fita LED 5000 RSC50 2.0/PLEDC ou 5000 RSC50 2.0/PLED-ST (opcional), para a iluminação de módulos inferiores de bancada.

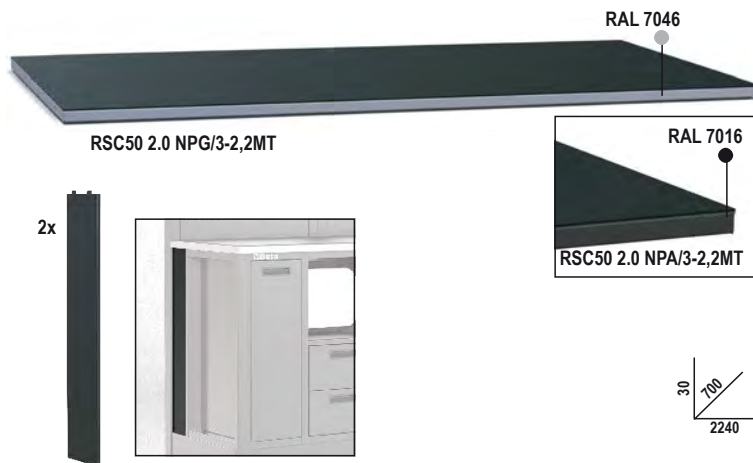

49,6 kg

RSC50 2.0 NPA/2-2,2MT	€ 1.130,00	1	050001132
RSC50 2.0 NPG/2-2,2MT	€ 1.130,00	1	050001133

## RSC50 2.0 PW/1-0,7MT

plano de trabalho em madeira laminada, 0,75 m de comprimento, para bancada de trabalho, para combinar com mobiliário de oficina RSC50 2.0

Plano de trabalho (750x700 mm) em madeira laminada. Fornecido com dois apoios laterais.

Permite instalação de torno (1599P/125, a encomendar separadamente)

7 kg

RSC50 2.0 PW/1-0,7MT	€ 293,00	1	050001126
----------------------	----------	---	-----------

## RSC50 2.0 PX/1-0,7MT

plano de trabalho em MDF revestido a aço inox, 0,75 m de comprimento, para bancada de trabalho, para combinar com mobiliário de oficina RSC50 2.0

Plano de trabalho (750x700 mm) em MDF revestido a aço inox. Fornecido com dois apoios laterais.

Permite instalação de torno (1599P/125, a encomendar separadamente)

13,5 kg

RSC50 2.0 PX/1-0,7MT	€ 347,00	1	050001127
----------------------	----------	---	-----------

## RSC50 2.0 PW/2-1,5MT

plano de trabalho em madeira laminada, 1,5 m de comprimento, para bancada de trabalho, para combinar com mobiliário de oficina RSC50 2.0

Plano de trabalho (1495x700 mm) em madeira laminada. Fornecido com dois apoios laterais.

Permite instalação de torno (1599P/125, a encomendar separadamente)

14,5 kg

RSC50 2.0 PW/2-1,5MT	€ 423,00	1	050001130
----------------------	----------	---	-----------

## RSC50 2.0 PX/2-1,5MT

plano de trabalho em MDF revestido a aço inox, 1,5 m de comprimento, para bancada de trabalho, para combinar com mobiliário de oficina RSC50 2.0

Plano de trabalho (1495x700 mm) em MDF revestido a aço inox. Fornecido com dois apoios laterais.

Permite instalação de torno (1599P/125, a encomendar separadamente)

27 kg

RSC50 2.0 PX/2-1,5MT	€ 540,00	1	050001131
----------------------	----------	---	-----------



## RSC50 2.0 PW/3-2,2MT

plano de trabalho em madeira laminada, 2,2 m de comprimento, para bancada de trabalho, para combinação de equipamento de oficina RSC50 2.0

Plano de trabalho (2240x700 mm) em madeira laminada. Fornecido com dois apoios laterais.

Permite instalação de torno (1599P/125, a encomendar separadamente)

21 kg



RSC50 2.0 PW/3-2,2MT

€ 610,00 1 050001136

## RSC50 2.0 PX/3-2,2MT

plano de trabalho em MDF revestido a aço inox, 2,2 m de comprimento, para bancada de trabalho, para combinar com mobiliário de oficina RSC50 2.0

Plano de trabalho (2240x700 mm) em MDF revestido a aço inox. Fornecido com dois apoios laterais.

Permite instalação de torno (1599P/125, a encomendar separadamente)

40,5 kg



RSC50 2.0 PX/3-2,2MT

€ 715,00 1 050001137

## RSC50 2.0 RB

revestimento em PVC anti-impacto, anti-riscos, resistente a hidrocarbonetos, para combinar com mobiliário de oficina, RSC50  
Um essencial para proteger bancadas de trabalho.

RSC50 RB/0,63: para bancada de canto, 630x630 mm

RSC50 RB/0,75: para bancada de 750 mm de comprimento

RSC50 RB/1,5: para bancada de 1495 mm de comprimento

RSC50 RB/2,2: para bancada de 2240 mm de comprimento



	€		
RSC50 RB/0,63	59,50	1	050001140
RSC50 RB/0,75	71,50	1	050001141
RSC50 RB/1,5	143,00	1	050001142
RSC50 RB/2,2	215,00	1	050001143

## RSC50 2.0 C5

carro de ferramentas com 5 gavetas, para combinar com mobiliário de oficina, RSC50 2.0

- 5 gavetas (588x367 mm) com guias de rolamentos de esferas
- 4 rodízios direcionáveis, Ø 100 mm (2 com travão)
- Fundo das gavetas protegido com tapete de borracha
- Fechadura frontal centralizada
- Pegas integradas na estrutura para maior facilidade de manuseamento
- Cada gaveta permite instalar até 4 maleáveis ou rígidos

58 kg

h	max
70 mm	25 kg
140 mm	30 kg
280 mm	35 kg

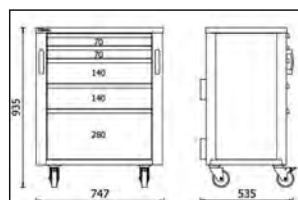
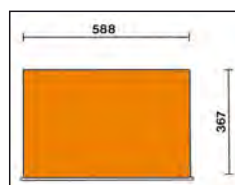

RSC50 2.0 C5

€ 1.960,00 1 050001205

800 kg



## RSC50 2.0 C6

carro de ferramentas com 6 gavetas, para combinar com mobiliário de oficina RSC50 2.0

- 6 gavetas (588x367 mm) com guias de rolamentos de esferas
- 4 rodízios direcionáveis, Ø 100 mm (2 com travões)
- Fundo das gavetas protegido com tapete de borracha
- Fechadura frontal centralizada
- Pegas integradas na estrutura para maior facilidade de manuseamento
- Cada gaveta permite instalar até 4 painéis maleáveis ou rígidos

61 kg

h	max
70 mm	25 kg
140 mm	30 kg
280 mm	35 kg

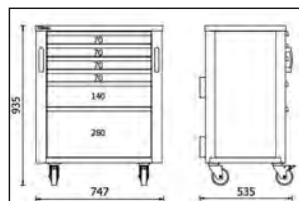
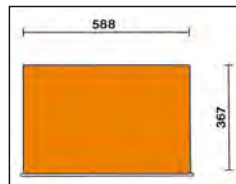

800 kg



RSC50 2.0 C6

€ 2.010,00 1 050001206

## RSC50 2.0 C7

carro de ferramentas com 7 gavetas, para combinar com mobiliário de oficina, RSC50 2.0

- 7 gavetas (588x367 mm) com guias de rolamentos de esferas
- 4 rodízios direcionáveis, Ø 100 mm (2 com travão)
- Fundo das gavetas protegido com tapete de borracha
- Fechadura frontal centralizada
- Pegas integradas na estrutura para maior facilidade de manuseamento
- Cada gaveta permite instalar até 4 painéis maleáveis ou rígidos

62 kg

h	max
70 mm	25 kg
280 mm	35 kg

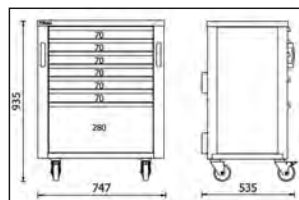
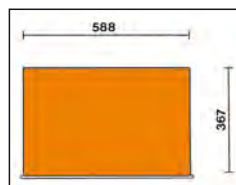

800 kg



RSC50 2.0 C7

€ 2.050,00 1 050001207



**Beta**

## RSC50 2.0 C8

carro de ferramentas com 8 gavetas, para combinar com mobiliário de oficina, RSC50 2.0

- 8 gavetas (588x367 mm) com guias de rolamentos de esferas
- 4 rodízios direcionáveis, Ø 100 mm (2 com travão)
- Fundo das gavetas protegido com tapete de borracha
- Fechadura frontal centralizada
- Pegas integradas na estrutura para maior facilidade de manuseamento
- Cada gaveta permite instalar até 4 maleáveis ou rígidos

64 kg

RSC50 2.0 C8

€ 2.090,00 1 050001208

h	max
70 mm	25 kg
140 mm	30 kg

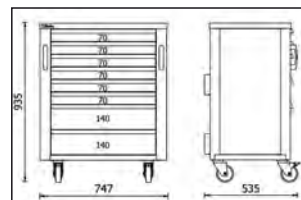
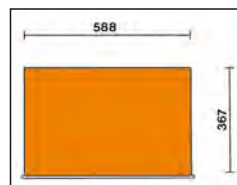

## RSC50 2.0 M4

módulo fixo com 4 gavetas, para combinar com mobiliário de oficina, RSC50 2.0

- 4 gavetas (588x367 mm) com guias de rolamentos de esferas
- Fundo das gavetas protegido com tapete de borracha
- Fechadura frontal centralizada
- Pés com regulação vertical
- Cada gaveta permite instalar até 4 maleáveis ou rígidos

61,5 kg

RSC50 2.0 M4

€ 1.660,00 1 050001264

h	max
140 mm	30 kg
280 mm	35 kg

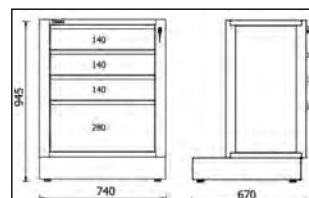
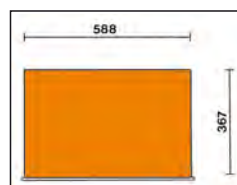

## RSC50 2.0 M5

módulo fixo com 5 gavetas, para combinar com mobiliário de oficina, RSC50 2.0

- 5 gavetas (588x367 mm) com guias de rolamentos de esferas
- Fundo das gavetas protegido com tapete de borracha
- Fechadura frontal centralizada
- Pés com regulação vertical
- Cada gaveta permite instalar até 4 maleáveis ou rígidos

63,5 kg

RSC50 2.0 M5

€ 1.710,00 1 050001265

h	max
70 mm	25 kg
140 mm	30 kg
280 mm	35 kg

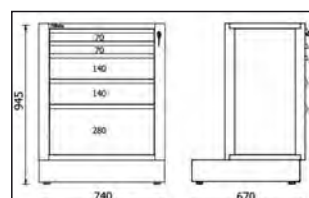
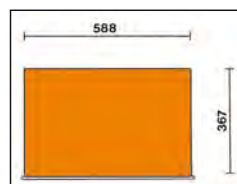



## RSC50 2.0 M6

módulo fixo com 6 gavetas, para combinar com mobiliário de oficina RSC50 2.0

- 6 gavetas (588x367 mm) com guias de rolamentos de esferas
- Fundo das gavetas protegido com tapete de borracha
- Fechadura frontal centralizada
- Pés com regulação vertical
- Cada gaveta permite instalar até 4 tabuleiros maleáveis ou rígidos

65,5 kg

h	max
70 mm	25 kg
140 mm	30 kg
280 mm	35 kg

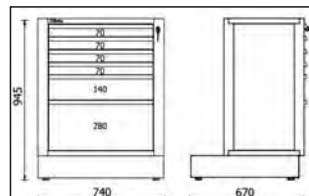
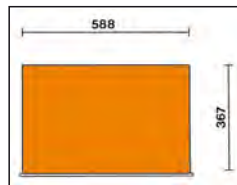

RSC50 2.0 M6

€ 1.750,00 1 050001226

## RSC50 2.0 M7

módulo fixo com 7 gavetas, para combinar com mobiliário de oficina, RSC50 2.0

- 7 gavetas (588x367 mm) com guias de rolamentos de esferas
- Fundo das gavetas protegido com tapete de borracha
- Fechadura frontal centralizada
- Pés com regulação vertical
- Cada gaveta permite instalar até 4 maleáveis ou rígidos

67,5 kg

h	max
70 mm	25 kg
280 mm	35 kg

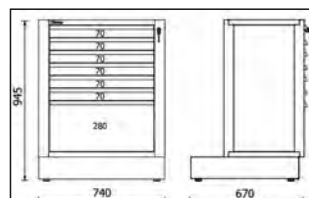
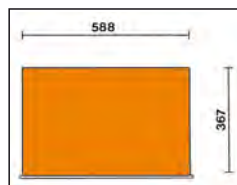

RSC50 2.0 M7

€ 1.800,00 1 050001267

## RSC50 2.0 M8

módulo fixo com 8 gavetas, para combinar com mobiliário de oficina, RSC50 2.0

- 8 gavetas (588x367 mm) com guias de rolamentos de esferas
- Fundo das gavetas protegido com tapete de borracha
- Fechadura frontal centralizada
- Pés com regulação vertical
- Cada gaveta permite instalar até 4 maleáveis ou rígidos

69,5 kg

h	max
70 mm	25 kg
140 mm	30 kg

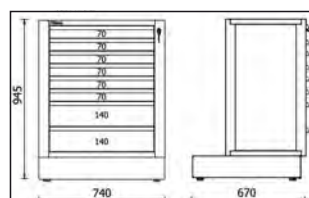
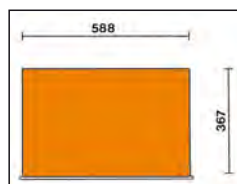

RSC50 2.0 M8

€ 1.840,00 1 050001268

## RSC50 2.0 M10

módulo fixo com 10 gavetas, para combinar com mobiliário de oficina, RSC50 2.0

- 10 gavetas (588x367 mm) com guias de rolamentos de esferas
- Fundo das gavetas protegido com tapete de borracha
- Fechadura frontal centralizada
- Pés com regulação vertical
- Cada gaveta permite instalar até 4 maleáveis ou rígidos

76 kg

h	max
70 mm	25 kg

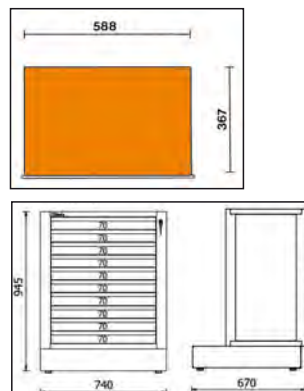

RSC50 2.0 M10

€ 1.930,00

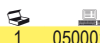

1 050001231

## RSC50 2.0 MS-2C

módulo de serviço, fixo, para combinar com mobiliário de oficina, RSC50 2.0

- Caixa de lixo integrado
- Compartimento para rolo de papel
- Duas gavetas, 310x370 mm, 180 mm de altura, com guias de rolamentos de esferas (dimensões internas)
- Pés com regulação vertical

49 kg

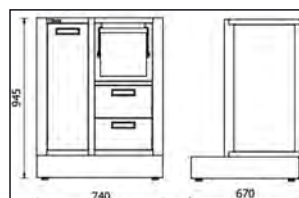

RSC50 2.0 MS-2C

€ 1.680,00

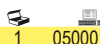

1 050001283

## RSC50 2.0 MS-AVV

módulo de serviço fixo, para combinar com mobiliário de oficina, RSC50 2.0, vazio

Permite utilizar dois enroladores, a escolher de entre os seguintes modelos:

- Enrolador para ar comprimido 1900S 8x10
- Enrolador de cabo elétrico 1843 15-H05, 1844 10-H05, 1844 15-H05, 1844 15-H07, 1844 15-H05/SCK, 1844 15-H07/SCK, 1845 12-H05, 1846 10-H05, 1846 10-H07 e 1846 15-H05

- Caixa de lixo integrado
- Compartimento para rolo de papel
- Pés com regulação vertical

49 kg

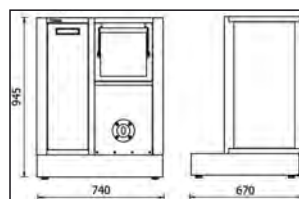

RSC50 2.0 MS-AVV

€ 1.550,00

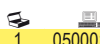

1 050001281

## RSC50 2.0 MS-2AVV

módulo de serviço, fixo, para combinar com mobiliário de oficina,  
RSC50 2.0, vazio

Permite utilizar dois enroladores, a escolher de entre os seguintes modelos:

- Enrolador para ar comprimido 1900S 8x10
- Enroladores de cabo elétrico 1843 15-H05, 1844 10-H05, 1844 15-H05, 1844 15-H07, 1844 15-H05/SCK, 1844 15-H07/SCK, 1845 12-H05, 1846 10-H05, 1846 10-H07 e 1846 15-H05

- Caixote de lixo integrado
- Compartimento para rolo de papel
- Pés com regulação vertical

50 kg

RSC50 2.0 MS-2AVV

€ 1.610,00 1 050001282

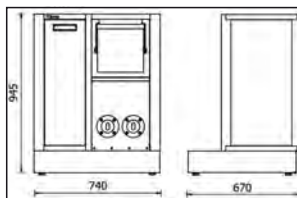

## RSC50 2.0 MA

módulo fixo com duas portas, para combinar com mobiliário de oficina,  
RSC50 2.0

- Com fechadura
- Prateleira interior com regulação vertical
- Dimensões internas: 615x435x740 mm
- Pés com regulação vertical

46 kg

RSC50 2.0 MA

€ 1.390,00 1 050001262

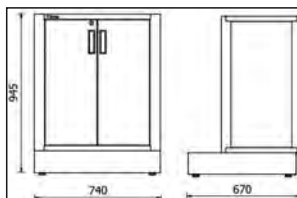

## RSC50 2.0 CS

módulo para resíduos diferenciados, para combinar com mobiliário de  
oficina, RSC50 2.0

- Compartimento de resíduos deslizante (588x355x580 mm) com guias de rolamentos de esferas
- 2 recipientes internos espaçosos para separação de lixo
- Pés com regulação vertical

48 kg

RSC50 2.0 CS

€ 1.610,00 1 050001285

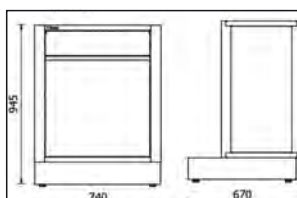



## RSC50 2.0 ML

módulo fixo com lavatório, para combinar com mobiliário de oficina, RSC50 2.0

Especificações:

- Lavatório em aço inox
- Fornecido com:
  - 1 torneira misturadora
  - 1 unidade de drenagem
  - 1 tampa do ralo
  - 1 tampa de filtro
  - 1 dispensador de sabão

Módulo fixo de duas portas com fechadura:

- Dimensões interiores: 615x435x575 mm
- Pés com regulação vertical

39 kg

RSC50 2.0 ML

€ 1.730,00



1



050001284

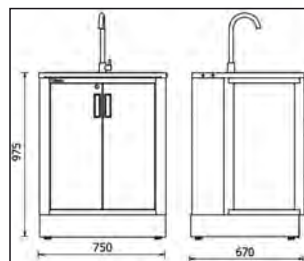

## RSC50 2.0 MDO

módulo fixo de distribuição de óleo, para combinar com mobiliário de oficina, RSC50 2.0

- 2 enroladores com tubo de 7m - 1/2" incluídos
- Equipado com 2 pistolas com contador de litros digital e coletor automático.
  - Débito: 30 l/min
  - Viscosidade: 8÷2000 mPas
- Pés com regulação vertical

92 kg

RSC50 2.0 MDO

€ 3.530,00



1



050001290

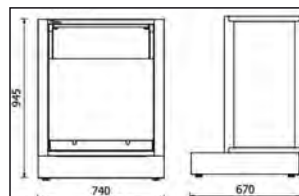

## RSC50 2.0 T3

carro de ferramentas com 3 prateleiras, para combinar com mobiliário de oficina, RSC50 2.0

- Quatro rodízios, Ø 100 mm (duas com travão)
- Capacidade de carga estática: 200 kg (distribuídos pelas 3 prateleiras)

23 kg

RSC50 2.0 T3

€ 380,00



1



050001253

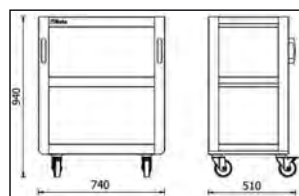

## RSC50 2.0 KPF

kit de painéis perfurados para ferramentas, para combinar com mobiliário de oficina, RSC50 2.0

Kit composto por:

- Um painel de ferramentas perfurado superior, 650x400x25 mm
- Um painel de ferramentas perfurado inferior, 650x625x25 mm, permite instalar uma tomada múltipla de 19" (não incluída)
- Um par de suportes direito/esquerdo

17,5 kg

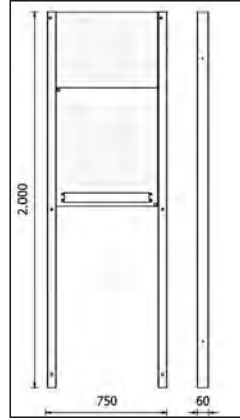
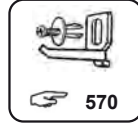

RSC50 2.0 KPF

€ 645,00 1 050001310

## RSC50 2.0 PFS

painel de ferramentas perfurado superior, para combinar com mobiliário de oficina, RSC50 2.0

- Dimensões: 650x400x25 mm

3 kg



RSC50 2.0 PFS

€ 184,00 1 050001312

## RSC50 2.0 PFI

painel de ferramentas perfurado inferior, para combinar com mobiliário de oficina, RSC50 2.0

- Dimensões: 650x625x25 mm
- permite instalar uma tomada múltipla de 19" (não incluída)

4,5 kg

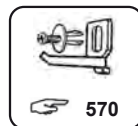

RSC50 2.0 PFI

€ 210,00 1 050001313

## RSC50 2.0 P/2MDX-SX

par de suportes verticais, direito/esquerdo, para painéis de ferramentas perfurados, para combinar com mobiliário de oficina, RSC50 S2.0

8,5 kg

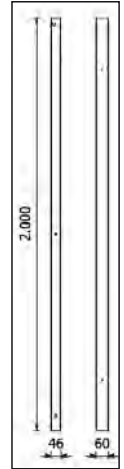

RSC50 2.0 P/2MDX-SX

€ 251,00 1 050001352

## RSC50 2.0 PM

armário suspenso, para combinar com mobiliário de oficina, RSC50 2.0

- Dimensões: 740x300x400 mm
- Equipado com amortecedores a gás, para fácil utilização da porta
- Indicado para aplicação de perfis em alumínio com fitas de LED artigo 5000 RSC50 2.0/PLEDC ou 5000 RSC50 2.0/PLED-ST (a serem solicitados separadamente), para iluminar área de trabalho e/ou interior de armário suspenso.

15 kg



30 kg

RSC50 2.0 PM

€ 600,00 1 050001302

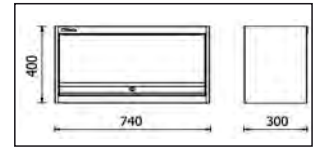

## RSC50 2.0 MTP

prateleira triangular, para combinar com mobiliário de oficina, RSC50 2.0

- Dimensões: 740x300x400 mm
- Permite a aplicação de perfis de alumínio com fita LED artigo 5000 RSC50 2.0/PLEDC ou 5000 RSC50 2.0/PLED-ST (opcional), para iluminar a área de trabalho

5 kg



10 kg

RSC50 2.0 MTP

€ 305,00 1 050001305



# Beta





## RSC50 2.0 PS

painel para ferramentas com persiana, para combinar com mobiliário de oficina, RSC50 2.0

- Persiana em alumínio, com regulação vertical, com fechadura
- Painel de ferramentas perfurado amovível
- Fornecido com estrutura
- Kit de 50 ganchos GPS incluído

80 kg

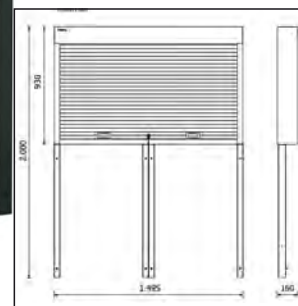

RSC50 2.0 PS

€ 2.700,00 1 050001360

## RSC50 2.0 NAC

canto completo, para combinar com mobiliário de oficina RSC50 2.0

- Plano de trabalho de canto (964x964 mm) em chapa pintada com revestimento PVC anti-impacto e anti-risco, resistente a hidrocarbonetos
- Armário de canto suspenso com fechadura e amortecedores a gás, para fácil utilização da porta
- 2 painéis perfurados para ferramentas (869x1027 mm)
- Módulo de canto inferior com compartimento de arrumação de grandes dimensões
- Pés com regulação vertical

143 kg



RSC50 2.0 NAC-A

RAL 7016

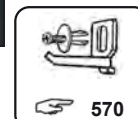

RAL 7046

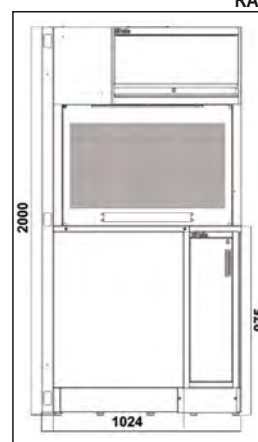

RSC50 2.0 NAC-G

RSC50 2.0 NAC-A

€ 5.350,00 1 050001339

RSC50 2.0 NAC-G

€ 5.450,00 1 050001340

# Beta

## RSC50 2.0 NAC-W

canto completo, para combinar com mobiliário de oficina RSC50 2.0

- Plano de trabalho de canto (964x964 mm) em madeira laminada
- Armário de canto suspenso com fechadura e amortecedores a gás, para fácil utilização da porta
- 2 painéis perfurados para ferramentas (869x1,027 mm)
- Módulo de canto inferior com compartimento de arrumação de grandes dimensões
- Pés com regulação vertical

139 kg

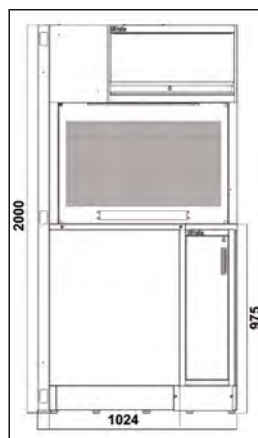
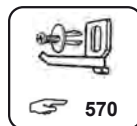

RSC50 2.0 NAC-W

RSC50 2.0 NAC-W

€ 4.680,00 1 050001327

## RSC50 2.0 NAC-X

canto completo, para combinar com mobiliário de oficina RSC50 2.0

- Plano de trabalho de canto (964x964 mm) em MDF revestido a aço inox
- Armário de canto suspenso com fechadura e amortecedores a gás, para fácil utilização da porta
- 2 painéis perfurados para ferramentas (869x1027 mm)
- Módulo de canto inferior com compartimento de arrumação de grandes dimensões
- Pés com regulação vertical

148 kg

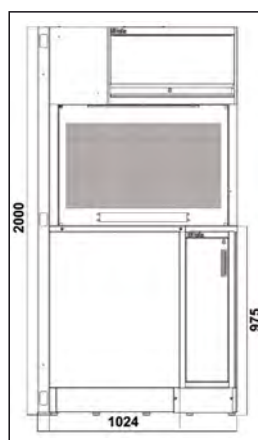
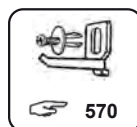

RSC50 2.0 NAC-X

RSC50 2.0 NAC-X

€ 4.740,00 1 050001328

## RSC50 2.0 KNAI

módulo de canto inferior, para combinar com mobiliário de oficina RSC50 2.0

- Plano de trabalho (964x964 mm) em chapa de aço pintada com revestimento PVC anti-risco e anti-impacto, resistente a hidrocarbonetos
- Módulo de canto fixo com compartimento de arrumação de grandes dimensões
- Pés com regulação vertical

80 kg



RAL 7046

RAL 7016

RSC50 2.0 KNAI-A

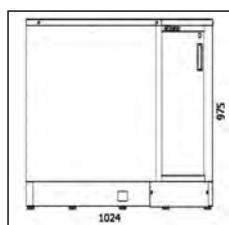

RSC50 2.0 KNAI-G

RSC50 2.0 KNAI-A 3.200,00 1 050001345

RSC50 2.0 KNAI-G 3.300,00 1 050001346

## RSC50 2.0 KNAI-W

módulo de canto inferior, para combinar com mobiliário de oficina RSC50 2.0

- Plano de trabalho (964x964 mm) em madeira laminada
- Módulo de canto fixo com compartimento de arrumação de grandes dimensões
- Pés com regulação vertical

76 kg

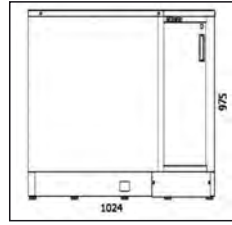

RSC50 2.0 KNAI-W

RSC50 2.0 KNAI-W

€ 2.520,00 1 050001337

## RSC50 2.0 KNAI-X

módulo de canto inferior, para combinar com mobiliário de oficina RSC50 2.0

- Plano de trabalho (964x964 mm) em MDF revestido a aço inox
- Módulo de canto fixo com compartimento de arrumação de grandes dimensões
- Pés com regulação vertical

85 kg

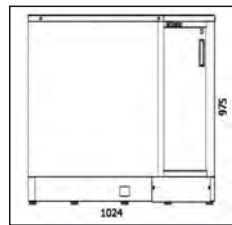

RSC50 2.0 KNAI-X

RSC50 2.0 KNAI-X

€ 2.590,00 1 050001338

## RSC50 2.0 A1

armário para ferramentas em chapa com uma porta, para combinar com mobiliário de oficina, RSC50 2.0

- 4 prateleiras amovíveis com regulação vertical
- Varão para vestuário sob a primeira prateleira
- Com fechadura
- Dimensões interiores: 590x615 mm
- Pés com regulação vertical

67 kg

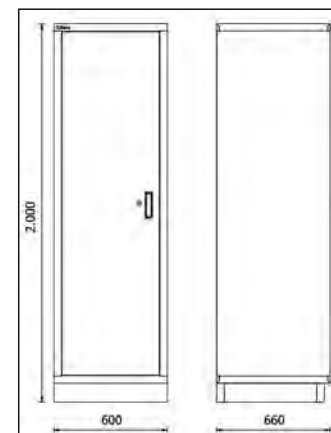

RSC50 2.0 A1

€ 955,00 1 050001411

## RSC50 2.0 A1/R59

prateleira interior para armário de ferramentas RSC50 A1

3,1 kg



RSC50 2.0 A1/R59 605x596 mm

€ 59,50 1 050001913



## RSC50 2.0 A1/RB59

prateleira interior para armário de ferramentas RSC50 A1, com varão para vestuário

3,4 kg

RSC50 2.0 A1/RB59 605x596 mm € 70,50 1 050001914

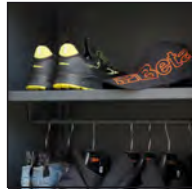

## RSC50 2.0 A2

armário para ferramentas em chapa, com duas portas, para combinar com mobiliário de oficina, RSC50 2.0

- 4 prateleiras amovíveis com regulação vertical
- Com fechadura
- Dimensões internas: 910x615 mm
- Pés com regulação vertical

85 kg

RSC50 2.0 A2 1.460,00 € 1 050001412

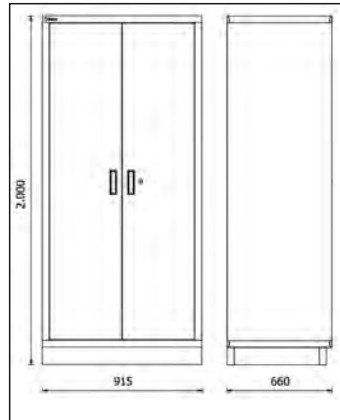

## RSC50 2.0 A2/3C

armário de ferramentas com duas portas em chapa e 3 gavetas, para mobiliário modular para oficina RSC50 2.0

- 4 prateleiras amovíveis com regulação vertical
- Fornecido com módulo de 3 gavetas (681x360 mm)
- Fechadura frontal
- Dimensões interiores: 910x615 mm
- Pés com regulação vertical

105,50 kg

RSC50 2.0 A2/3C 1.750,00 € 1 050001413

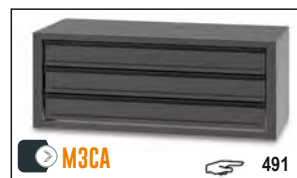

M3CA 491

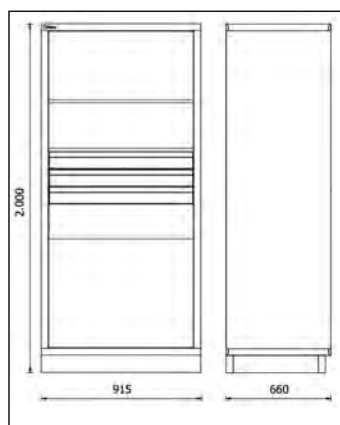

## RSC50 2.0 A2/R91

prateleira interior para armário de ferramentas RSC50 A2

4,2 kg

RSC50 2.0 A2/R91 911x596 mm € 86,00 1 050001915



## 5000 RSC50 2.0/MP

prateleira, para combinar com mobiliário de oficina, RSC50 2.0

- Dimensões: 740x140x80 mm
- Permite a aplicação de perfis de alumínio com fita LED artigo 5000 RSC50 2.0/PLEDC ou 5000 RSC50 2.0/PLED-ST (opcional), para iluminar a área de trabalho

2,0 kg

5000 RSC50 2.0/MP € 139,00 1 050001705



## 5000 RSC50/MPA140

prateleira de canto, 140 mm de profundidade, para combinar com mobiliário de oficina, RSC50

- Dimensões: 630x630x35 mm, 140 mm de profundidade
- Permite a aplicação de perfis de alumínio com fita LED artigo 5000 RSC50 2.0/PLEDC ou 5000 RSC50 2.0/PLED-ST (opcional), para iluminar a área de trabalho

3,8 kg

5000 RSC50/MPA140 € 183,00 1 050001706



## 5000 RSC50 2.0/CLL

resguardo linear, para combinar com mobiliário de oficina RSC50 2.0

- Dimensões: 740x125x30 mm
- Para aplicar em painéis de ferramentas perfurados
- Concebido para aplicação de perfis em alumínio com fita LED artigo 5000 RSC50 2.0/PLEDC ou 5000 RSC50 2.0/PLED-ST (opcional), para iluminar a área de trabalho

1 kg

5000 RSC50 2.0/CLL € 139,00 1 050001710



## 5000 RSC50/CAL

resguardo de canto, para combinar com mobiliário de oficina RSC50

- Dimensões: 655x655x30 mm
- Concebido para aplicação de perfis em alumínio com fita LED artigo 5000 RSC50 2.0/PLEDC ou 5000 RSC50 2.0/PLED-ST (opcional), para iluminar a área de trabalho

1,2 kg

5000 RSC50/CAL € 183,00 1 050001711



## 5000 RSC50 2.0/KFC

kit de 10 frentes de gaveta coloridas, para combinar com mobiliário de oficina RSC50 2.0

Para personalizar a cor das frentes das gavetas para combinar com mobiliário de oficina RSC50 2.0

Recomendado para utilização em combinação com bancadas em cinza antracite RAL7016 (-A).

Artigo	Cor	Preço (€)	Qtd.	Referência
5000 RSC50 2.0/KFC2011	Amarelo	96,50	1	050001731
5000 RSC50 2.0/KFC3000	Vermelho	96,50	1	050001733
5000 RSC50 2.0/KFC5015	Azul	96,50	1	050001734
5000 RSC50 2.0/KFC7016	Cinza	96,50	1	050001737





# MOBILIÁRIO PARA OFICINA C45PRO 2.0

## ORGULHAMO-NOS DE APRESENTAR A VERSÃO 2.0 DA NOSSA LINHA DE SUCESSO, C45PRO.

Tendo por base a nova bancada de 61,5 cm de comprimento, esta gama destaca-se por ser ainda mais cómoda e profissional, para responder às necessidades dos profissionais cada vez mais exigentes.

O mobiliário modular para oficina, **C45PRO 2.0**, permite-lhe criar o seu próprio espaço de trabalho em função do espaço disponível e das suas necessidades de utilização. Esta linha simples e versátil, baseada em combinações pré-determinadas, pode expandir-se ou alterar-se ao longo do tempo.

Em alternativa, pode personalizar completamente o seu posto de trabalho, começando pelas bancadas - disponíveis em MDF com revestimento em aço inoxidável ou madeira laminada - e complementando-as com os inúmeros componentes e acessórios que tem à sua disposição.

- Personalize o seu local de trabalho para que se adequue às suas necessidades
- Remodele a sua garagem ou oficina
- Faça a sua escolha a partir das soluções pré-montadas
- Crie o seu posto de trabalho de raiz



Aceda a [www.beta-tools.com](http://www.beta-tools.com)



para configurar a sua oficina online

# Beta

## C45PRO 2.0

### C45PRO 2.0 DX

combinação de mobiliário modular para oficina C45PRO 2.0

Combinação composta por:

- 1 superfície de trabalho em MDF revestido a aço inox 2040x615 mm (C45PRO 2.0 PXE/3-2,0MT)
- 1 superfície de trabalho em MDF revestido a aço inox 1360x615 mm (C45PRO 2.0 PXE/2-1,3MT)
- 1 módulo fixo com 7 gavetas (C45PRO 2.0 M7)
- 1 carro de ferramentas com 7 gavetas (C45PRO 2.0 C7)
- 1 módulo de serviço fixo (C45PRO 2.0 MS)
- 1 módulo fixo com 5 gavetas (C45PRO 2.0 M5)
- 1 módulo fixo com duas portas (C45PRO 2.0 MA)
- 1 canto completo com bancada em MDF revestido a aço inox (C45PRO 2.0 CORNER/X)
- 5 painéis de ferramentas perfurados (C45PRO 2.0 PF)
- 5 armários suspensos (C45PRO 2.0 PM)
- 7 suportes de parede, tipo largo (C45PRO 2.0 SL)
- 2 suporte de parede, tipo estreito (C45PRO 2.0 SS)
- 2 armários de uma porta (C45PRO 2.0 AS1)

640 kg

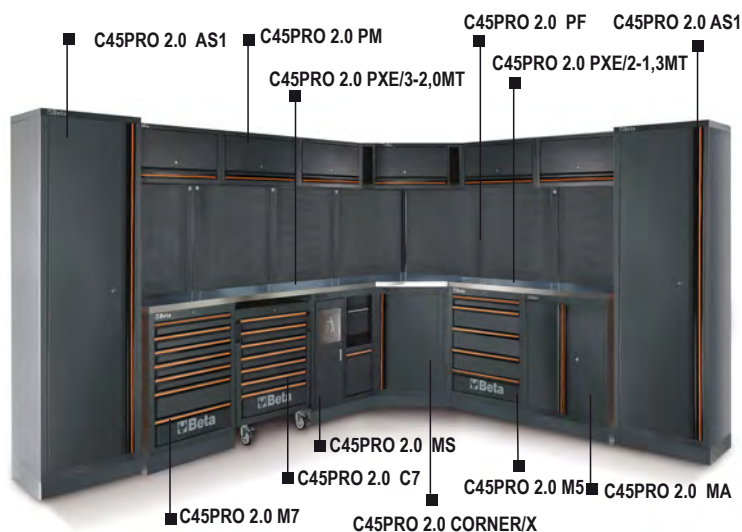

C45PRO 2.0 DX

€ 11.100,00 1 045002031

2000  
845  
3718  
3038



## C45PRO 2.0 DW

combinação de mobiliário modular para oficina C45PRO 2.0

Combinação composta por:

- 1 superfície de trabalho em madeira laminada 2040x615 mm (C45PRO 2.0 PWE/3-2,0MT)
- 1 superfície de trabalho em madeira laminada 1360x615 mm (C45PRO 2.0 PWE/2-1,3MT)
- 1 módulo fixo com 7 gavetas (C45PRO 2.0 M7)
- 1 carro de ferramentas com 7 gavetas (C45PRO 2.0 C7)
- 1 módulo de serviço fixo (C45PRO 2.0 MS)
- 1 módulo fixo com 5 gavetas (C45PRO 2.0 M5)
- 1 módulo fixo com duas portas (C45PRO 2.0 MA)
- 1 canto completo com bancada em madeira laminada (C45PRO 2.0 CORNER/W)
- 5 painéis de ferramentas perfurados (C45PRO 2.0 PF)
- 5 armários suspensos (C45PRO 2.0 PM)
- 7 suportes de parede, tipo largo (C45PRO 2.0 SL)
- 2 suporte de parede, tipo estreito (C45PRO 2.0 SS)
- 2 armários de uma porta (C45PRO 2.0 AS1)

606 kg

C45PRO 2.0 DW

10.800,00



1



045002032

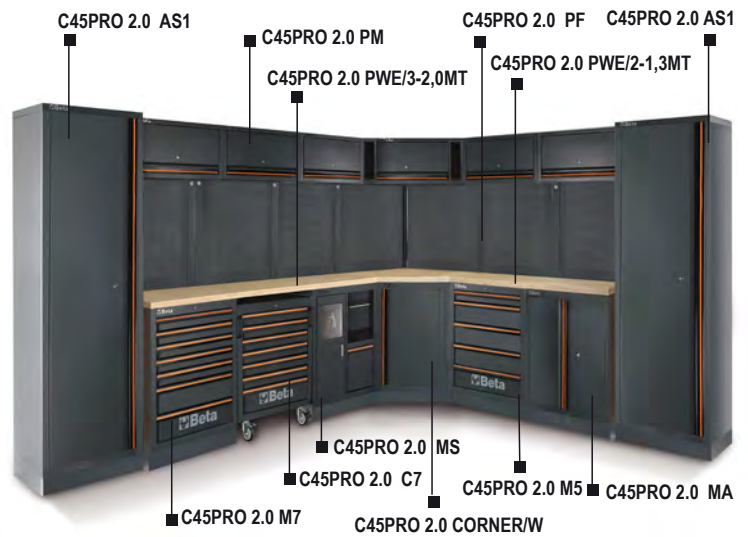

## C45PRO 2.0 FX

Mobiliário modular para oficina C45PRO 2.0

Combinação compreendendo:

- 1 Plano de trabalho em MDF revestido a aço inox, 2040x615 mm (C45PRO 2.0 PXE/3-2,0MT)
- 1 Plano de trabalho em MDF revestido a aço inox, 1360x615 mm (C45PRO 2.0 PXE/2-1,3MT)
- 1 módulo fixo com duas portas (C45PRO 2.0 MA)
- 1 carro de ferramentas com 7 gavetas (C45PRO 2.0 C7)
- 1 módulo fixo com 7 gavetas (C45PRO 2.0 M7)
- 1 módulo fixo com 2 enroladores integrados (C45PRO 2.0 ACT)
- 1 módulo de serviço fixo (C45PRO 2.0 MS)
- 1 canto completo com plano de trabalho em MDF revestido a aço inox (C45PRO 2.0 CORNER/X)
- 2 painéis de ferramentas perfurados (C45PRO 2.0 PF)
- 1 painel de ferramentas perfurado, pode ser equipado com uma tomada (não incluída) (C45PRO 2.0 PFE)
- 3 armários suspensos (C45PRO 2.0 PM)
- 1 armário suspenso com persiana em alumínio (C45PRO 2.0 PAS)
- 6 suportes de parede, tipo largo (C45PRO 2.0 SL)
- 4 suportes de parede, tipo largo (C45PRO 2.0 SS)
- 2 armários de uma porta (C45PRO 2.0 AS1)

658 kg

C45PRO 2.0 FX

11.700,00



1



045002035

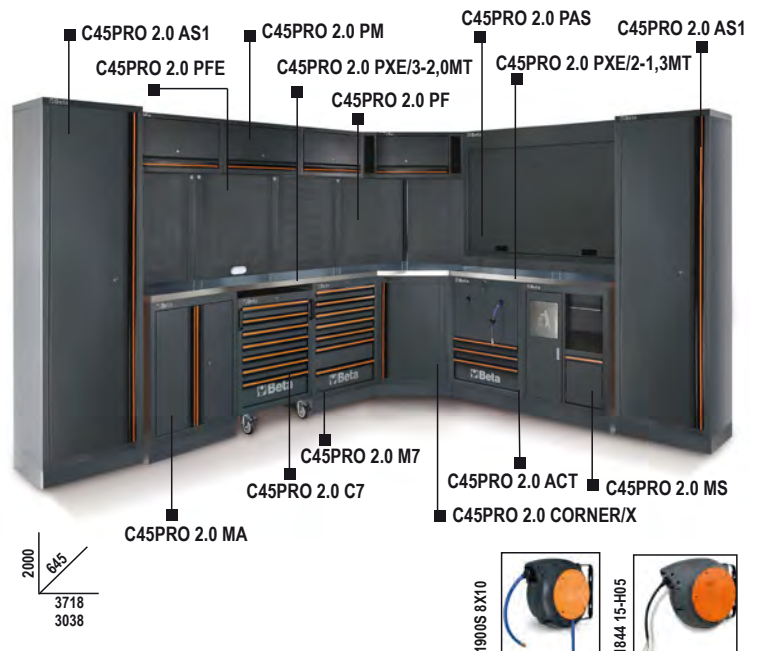

## C45PRO 2.0 FW

Mobiliário modular para oficina C45PRO 2.0

Combinação inclui:

- 1 Plano de trabalho em madeira laminada, 2040x615 mm (C45PRO 2.0 PWE/3-2,0MT)
- 1 Plano de trabalho em madeira laminada, 1600x615 mm (C45PRO 2.0 PWE/2-1,3MT)
- 1 módulo fixo de duas portas (C45PRO 2.0 MA)
- 1 carro de ferramentas com 7 gavetas (C45PRO 2.0 C7)
- 1 módulo fixo com 7 gavetas (C45PRO 2.0 M7)
- 1 módulo fixo com 2 enroladores integrados (C45PRO 2.0 ACT)
- 1 módulo de serviço fixo (C45PRO 2.0 MS)
- 1 canto completo com bancada em madeira laminada (C45PRO 2.0 CORNER/W)
- 2 painéis de ferramentas perfurados (C45PRO 2.0 PF)
- 1 painel de ferramentas perfurado, pode ser equipado com uma tomada (não incluída) (C45PRO 2.0 PFE)
- 3 armários suspensos (C45PRO 2.0 PM)
- 1 armário suspenso com persiana em alumínio (C45PRO 2.0 PAS)
- 6 suportes de parede, tipo largo (C45PRO 2.0 SL)
- 4 suportes de parede, tipo largo (C45PRO 2.0 SS)
- 2 armários de uma porta (C45PRO 2.0 AS1)

625 kg

C45PRO 2.0 FW

11.400,00



1



045002045

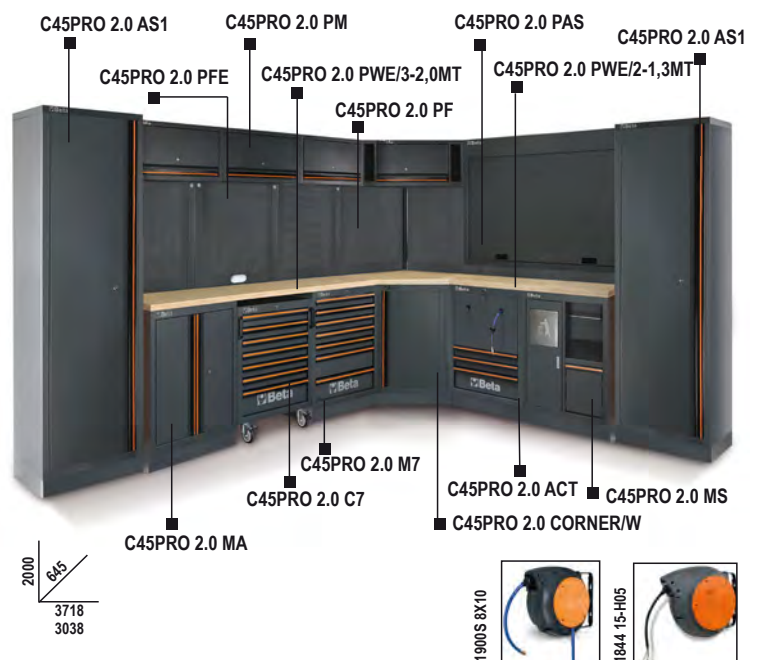

## C45PRO 2.0 GX

Mobiliário modular para oficina C45PRO 2.0

Combinação inclui:

- 1 Plano de trabalho em MDF revestido a aço inox, 2040x615 mm (C45PXE/3-2,0MT)
- 1 Plano de trabalho em MDF revestido a aço inox, 680x615 mm (C45PXE/1-0,7MT)
- 1 módulo fixo com 2 enroladores integrados (C45PRO 2.0 ACT)
- 1 carro de ferramentas com 7 gavetas (C45PRO 2.0 C7)
- 1 módulo fixo com 7 gavetas (C45PRO 2.0 M7)
- 1 módulo fixo com duas portas (C45PRO 2.0 MA)
- 1 módulo fixo com coletor integrado (C45PRO 2.0 ML)
- 1 canto completo com superfície de MDF revestida em aço inox (C45PRO 2.0 CORNER/X)
- 1 painel de ferramentas perfurado (C45PRO 2.0 PF)
- 1 painel de ferramentas perfurado, pode ser equipado com uma tomada (não incluída) (C45PRO 2.0 PFE)
- 2 armários suspensos (C45PRO 2.0 PM)
- 1 armário suspenso com persiana em alumínio (C45PRO 2.0 PAS)
- 5 suportes de parede, tipo largo (C45PRO 2.0 SL)
- 4 suportes de parede, tipo largo (C45PRO 2.0 SS)
- 2 armários de uma porta (C45PRO 2.0 AS1)

554 kg

C45PRO 2.0 GX

10.500,00



1



045002036

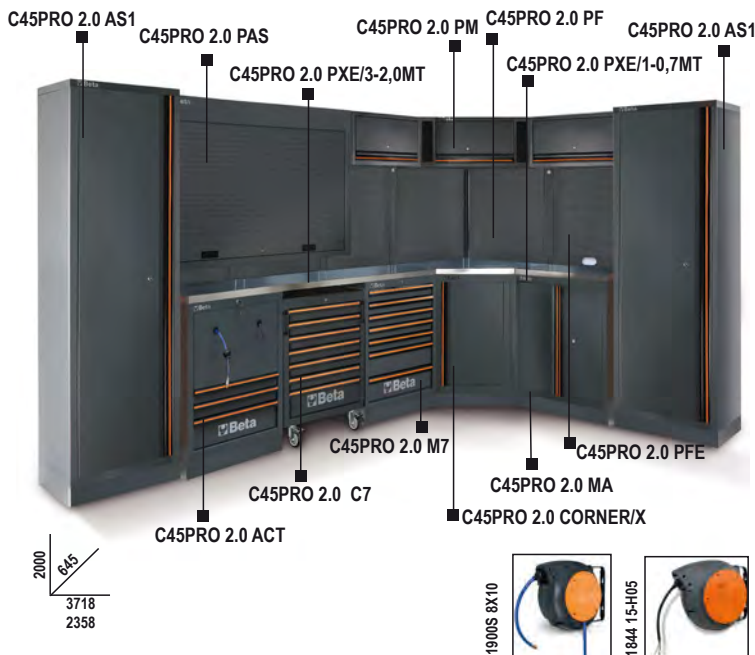

## C45PRO 2.0 GW

Mobiliário modular para oficina C45PRO 2.0

Combinação inclui:

- 1 Plano de trabalho em MDF revestido a aço inox, 2040x615 mm (C45PRO 2.0 PWE/3-2,0MT)
- 1 Plano de trabalho em MDF revestido a aço inox, 680x615 mm (C45PRO 2.0 PWE/1-0,7MT)
- 1 módulo fixo com 2 enroladores integrados (C45PRO 2.0 ACT)
- 1 carro de ferramentas com 7 gavetas (C45PRO 2.0 C7)
- 1 módulo fixo com 7 gavetas (C45PRO 2.0 M7)
- 1 módulo fixo de duas portas (C45PRO 2.0 MA)
- 1 canto completo com plano de trabalho em madeira laminada (C45PRO 2.0 CORNER/W)
- 1 painel de ferramentas perfurados (C45PRO 2.0 PF)
- 1 painel de ferramentas perfurado, pode ser equipado com uma tomada (não incluída) (C45PRO 2.0 PFE)
- 2 armários suspensos (C45PRO 2.0 PM)
- 1 armário suspenso com persiana em alumínio (C45PRO 2.0 PAS)
- 6 suportes de parede, tipo largo (C45PRO 2.0 SL)
- 2 suportes de parede, tipo largo (C45PRO 2.0 SS)
- 2 armários de uma porta (C45PRO 2.0 AS1)

551 kg

C45PRO 2.0 GW

10.200,00



1



045002037

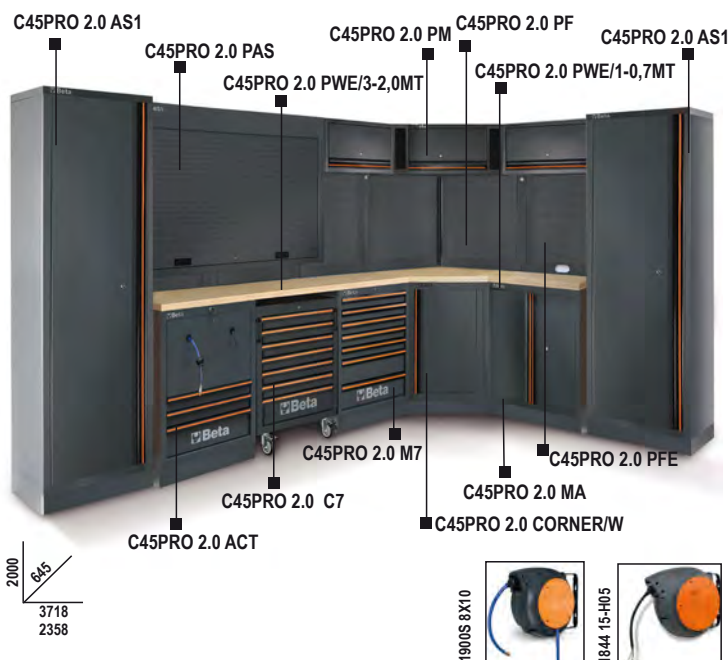

## C45PRO 2.0 X

combinação de mobiliário modular para oficina C45PRO 2.0

Combinação composta por:

- Superfície de trabalho em MDF revestido a aço inox 2040x615 mm (C45PRO 2.0 PXE/3-2,0MT)
- 1 módulo fixo com 7 gavetas (C45PRO 2.0 M7)
- 1 carro de ferramentas com 7 gavetas (C45PRO 2.0 C7)
- 1 módulo de serviço fixo (C45PRO 2.0 MS)
- 3 painéis de ferramentas perfurados (C45PRO 2.0 PF)
- 3 armários suspensos (C45PRO 2.0 PM)
- 3 suportes de parede, tipo largo (C45PRO 2.0 SL)
- 1 suporte de parede, tipo estreito (C45PRO 2.0 SS)
- 1 armário de duas portas (C45PRO 2.0 AS2)

334 kg

C45PRO 2.0 X

5.550,00



1



045002001

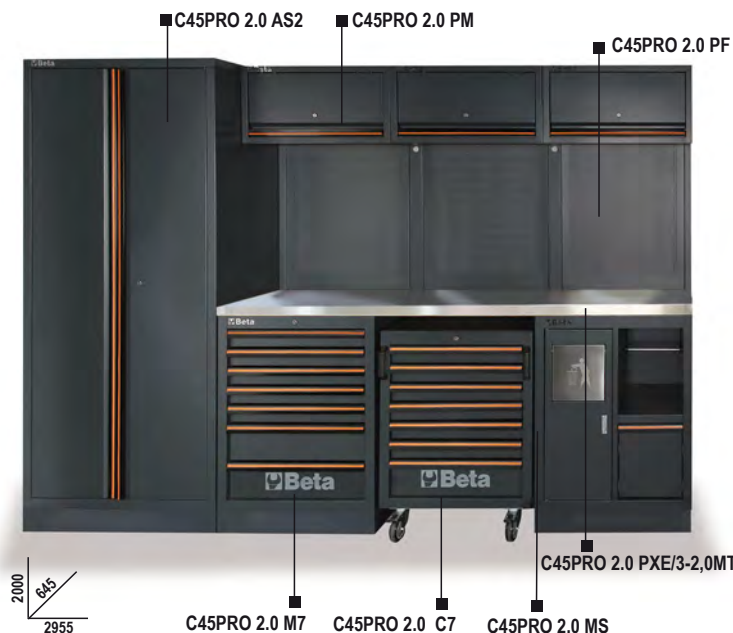



## C45PRO 2.0 W

combinação de mobiliário modular para oficina C45PRO 2.0

Combinação composta por:

- Superfície de trabalho em madeira laminada 2040x615 mm (C45PRO 2.0 PWE/3-2,0MT)
- 1 módulo fixo com 7 gavetas (C45PRO 2.0 M7)
- 1 carro de ferramentas com 7 gavetas (C45PRO 2.0 C7)
- 1 módulo de serviço fixo (C45PRO 2.0 MS)
- 3 painéis de ferramentas perfurados (C45PRO 2.0 PF)
- 3 armários suspensos (C45PRO 2.0 PM)
- 3 suportes de parede, tipo largo (C45PRO 2.0 SL)
- 1 suporte de parede, tipo estreito (C45PRO 2.0 SS)
- 1 armário de duas portas (C45PRO 2.0 AS2)

318 kg

C45PRO 2.0 W

€ 5.400,00 1 045002002

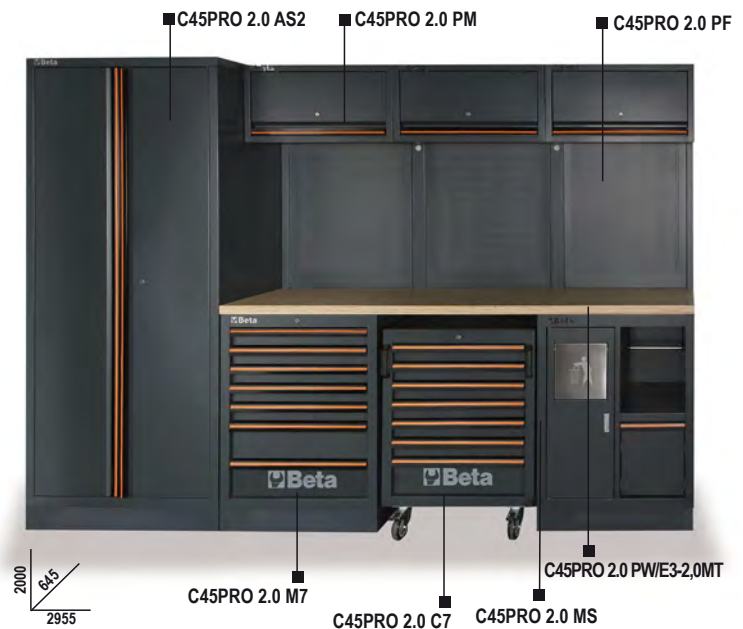

## C45PRO 2.0 HX

Mobiliário modular para oficina C45PRO 2.0

Combinação inclui:

- 1 Plano de trabalho em MDF revestido a aço inox, 2040x615 mm (C45PXE/3-2,0MT)
- 1 módulo fixo com 2 enroladores integrados (C45PRO 2.0 ACT)
- 1 carro de ferramentas com 7 gavetas (C45PRO 2.0 C7)
- 1 módulo fixo com 4 gavetas (C45PRO 2.0 M4)
- 3 armários suspensos (C45PRO 2.0 PM)
- 3 painéis de ferramentas perfurados (C45PRO 2.0 PF)
- 3 suportes de parede, tipo largo (C45PRO 2.0 SL)
- 1 suporte de parede, tipo estreito (C45PRO 2.0 SS)
- 1 armário de duas portas (C45PRO 2.0 AS2)

333 kg

C45PRO 2.0 HX

€ 5.950,00 1 045002038

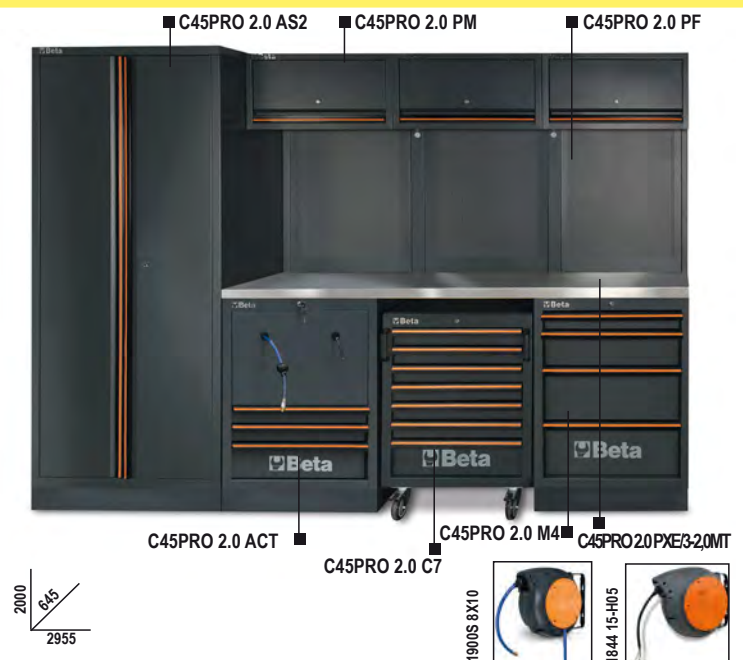

## C45PRO 2.0 HW

Mobiliário modular para oficina C45PRO 2.0

Combinação inclui:

- 1 Plano de trabalho em madeira laminada, 2040x615 mm (C45PWE/3-2,0MT)
- 1 módulo fixo com 2 enroladores integrados (C45PRO 2.0 ACT)
- 1 carro de ferramentas com 7 gavetas (C45PRO 2.0 C7)
- 1 módulo fixo com 4 gavetas (C45PRO 2.0 M4)
- 3 armários suspensos (C45PRO 2.0 PM)
- 3 painéis de ferramentas perfurados (C45PRO 2.0 PF)
- 3 suportes de parede, tipo largo (C45PRO 2.0 SL)
- 1 suporte de parede, tipo estreito (C45PRO 2.0 SS)
- 1 armário de duas portas (C45PRO 2.0 AS2)

318 kg

C45PRO 2.0 HW

€ 5.800,00 1 045002039

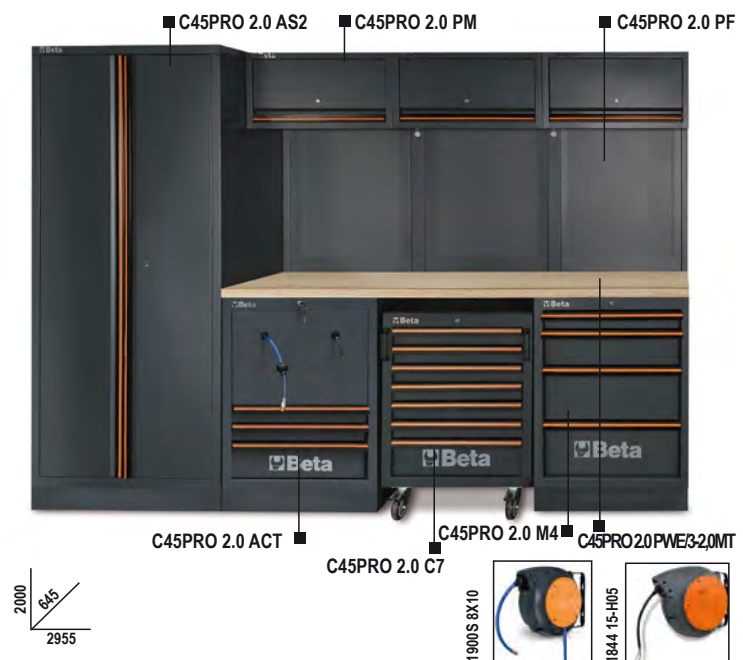



## C45PRO 2.0 AX

combinação de mobiliário modular para oficina C45PRO 2.0

Combinação composta por:

- Superfície de trabalho em MDF revestido a aço inox 2040x615 mm (C45PRO 2.0 PXE/3-2,0MT)
- 1 módulo de serviço fixo (C45PRO 2.0 MS)
- 1 módulo fixo com 7 gavetas (C45PRO 2.0 M7)
- 1 módulo fixo com duas portas (C45PRO 2.0 MA)
- 3 armários suspensos (C45PRO 2.0 PM)
- 3 painéis de ferramentas perfurados (C45PRO 2.0 PF)
- 2 suportes de parede, tipo largo (C45PRO 2.0 SL)
- 2 suporte de parede, tipo estreito (C45PRO 2.0 SS)

234,5 kg

C45PRO 2.0 AX

€ 3.860,00



1

045002003



## C45PRO 2.0 AW

combinação de mobiliário modular para oficina C45PRO 2.0

Combinação composta por:

- Superfície de trabalho em madeira laminada 2040x615 mm (C45PRO 2.0 PWE/3-2,0MT)
- 1 módulo de serviço fixo (C45PRO 2.0 MS)
- 1 módulo fixo com 7 gavetas (C45PRO 2.0 M7)
- 1 módulo fixo com duas portas (C45PRO 2.0 MA)
- 3 armários suspensos (C45PRO 2.0 PM)
- 3 painéis de ferramentas perfurados (C45PRO 2.0 PF)
- 2 suportes de parede, tipo largo (C45PRO 2.0 SL)
- 2 suporte de parede, tipo estreito (C45PRO 2.0 SS)

219 kg

C45PRO 2.0 AW

€ 3.750,00



1

045002004



## C45PRO 2.0 BX

combinação de mobiliário modular para oficina C45PRO 2.0

Combinação composta por:

- Superfície de trabalho em MDF revestido a aço inox 1360x615 mm (C45PRO 2.0 PXE/2-1,30MT)
- 1 módulo fixo com 5 gavetas (C45PRO 2.0 M5)
- 1 módulo de serviço fixo com duas portas (C45PRO 2.0 MA)
- 2 armários suspensos (C45PRO 2.0 PM)
- 2 painéis de ferramentas perfurados (C45PRO 2.0 PF)
- 2 suportes de parede, tipo largo (C45PRO 2.0 SL)
- 1 suporte de parede, tipo estreito (C45PRO 2.0 SS)
- 1 armário de uma porta (C45PRO 2.0 AS1)

206 kg

C45PRO 2.0 BX

€ 3.460,00



1

045002021

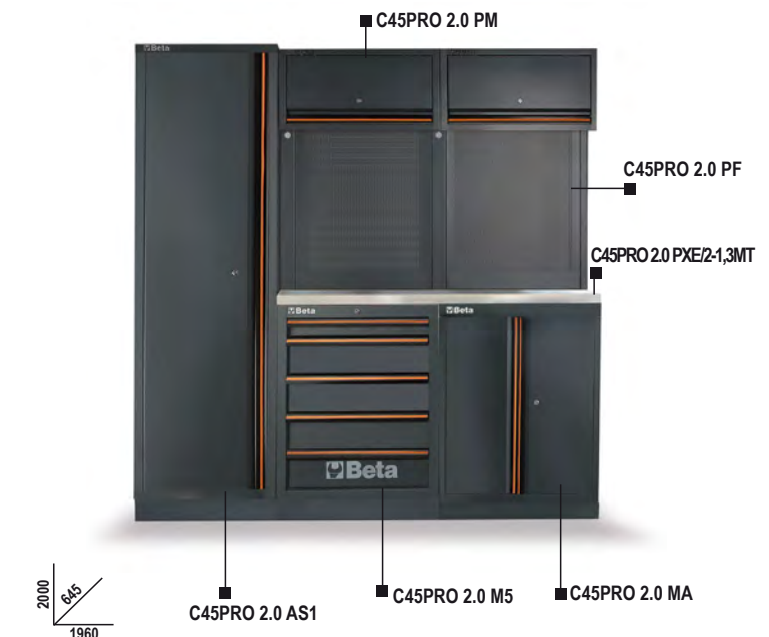

## C45PRO 2.0 BW

combinação de mobiliário modular para oficina C45PRO 2.0

Combinação composta por:

- Superfície de trabalho em madeira laminada 1360x615 mm (C45PRO 2.0 PWE/2-1.30MT)
- 1 módulo fixo com 5 gavetas (C45PRO 2.0 M5)
- 1 módulo fixo com duas portas (C45PRO 2.0 MA)
- 2 armários suspensos (C45PRO 2.0 PM)
- 2 painéis de ferramentas perfurados (C45PRO 2.0 PF)
- 2 suportes de parede, tipo largo (C45PRO 2.0 SL)
- 1 suporte de parede, tipo estreito (C45PRO 2.0 SS)
- 1 armário de uma porta (C45PRO 2.0 AS1)

196 kg

C45PRO 2.0 BW

€ 3.350,00

1

045002022

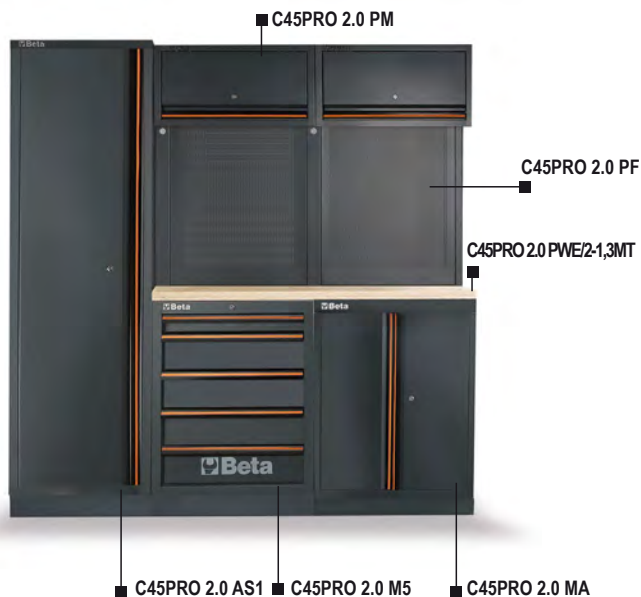

## C45PRO 2.0 EX

combinação de mobiliário modular para oficina C45PRO 2.0

Combinação composta por:

- 2 painéis de ferramentas perfurados (C45PRO 2.0 PF)
- 2 armários suspensos (C45PRO 2.0 PM)
- 2 suportes de parede, tipo largo (C45PRO 2.0 SL)
- 1 suporte de parede, tipo estreito (C45PRO 2.0 SS)
- 1 armário de uma porta (C45PRO 2.0 AS1)
- Módulo fixo com 7 gavetas e superfície de trabalho em MDF revestido a aço inox, dimensões 1360x615 mm (C45PRO 2.0 M7A/X):
  - 1 gaveta 1248x406 mm
  - 6 gavetas 782x406 mm
  - 5 gavetas, 65 mm de altura
  - 1 gaveta, 145 mm de altura
- 1 compartimento de armazenamento com prateleira e porta

203 kg

C45PRO 2.0 EX

€ 3.670,00

1

045002033



## C45PRO 2.0 EW

combinação de mobiliário modular para oficina C45PRO 2.0

Combinação composta por:

- 2 painéis de ferramentas perfurados (C45PRO 2.0 PF)
- 2 armários suspensos (C45PRO 2.0 PM)
- 2 suportes de parede, tipo largo (C45PRO 2.0 SL)
- 1 suporte de parede, tipo estreito (C45PRO 2.0 SS)
- 1 armário de ferramentas de uma porta (C45PRO 2.0 AS1)
- Módulo fixo com 7 gavetas e Plano de trabalho em madeira laminada, 1360x615 mm (C45PRO 2.0 M7A / W):
  - 1 gaveta, 1248x406 mm
  - 6 gavetas, 782x406 mm
  - 5 gavetas 65 mm de altura
  - 1 gaveta 145 mm de altura
- 1 compartimento de armazenamento com prateleira e porta

193 kg

C45PRO 2.0 EW

€ 3.560,00

1

045002034



## C45PRO 2.0 CX

combinação de mobiliário modular para oficina C45PRO 2.0

Combinação composta por:

- Superfície trabalho em MDF revestida a aço inox 1360x615 mm (C45PRO 2.0 PXE/2-1.30MT)
- 1 módulo de serviço fixo (C45PRO 2.0 MS)
- 1 módulo fixo com 7 gavetas (C45PRO 2.0 M7)
- 2 armários suspensos (C45PRO 2.0 PM)
- 2 painéis de ferramentas perfurados (C45PRO 2.0 PF)
- 2 suportes de parede, tipo largo (C45PRO 2.0 SL)
- 1 suporte de parede, tipo estreito (C45PRO 2.0 SS)
- 1 armário de uma porta (C45PRO 2.0 AS1)

225 kg

C45PRO 2.0 CX

€ 3.690,00



1

045002023

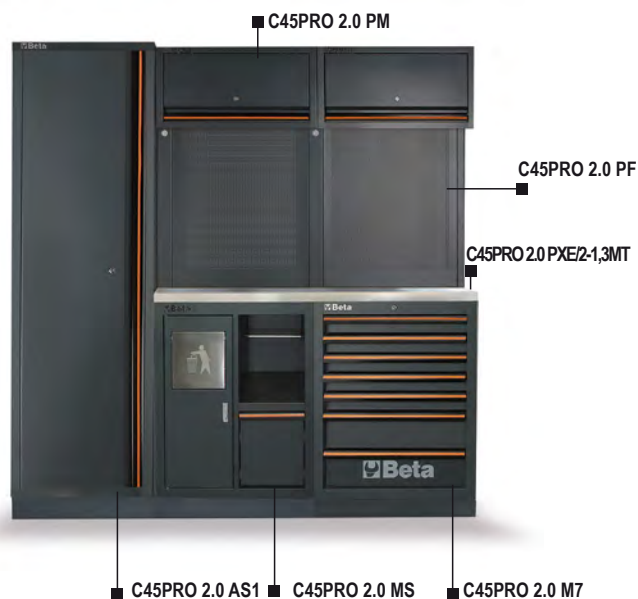

## C45PRO 2.0 CW

combinação de mobiliário modular para oficina C45PRO 2.0

Combinação composta por:

- Superfície de trabalho em madeira laminada 1360x615 mm (C45PRO 2.0 PWE/2-1.30MT)
- 1 módulo de serviço fixo (C45PRO 2.0 MS)
- 1 módulo fixo com 7 gavetas (C45PRO 2.0 M7)
- 2 armários suspensos (C45PRO 2.0 PM)
- 2 painéis de ferramentas perfurados (C45PRO 2.0 PF)
- 2 suportes de parede, tipo largo (C45PRO 2.0 SL)
- 1 suporte de parede, tipo estreito (C45PRO 2.0 SS)
- 1 armário de uma porta (C45PRO 2.0 AS1)

215 kg

C45PRO 2.0 CW

€ 3.590,00



1

045002024



## C45PRO 2.0 BPX-2,0

combinação de mobiliário modular para oficina C45PRO 2.0

Combinação inclui:

- Plano de trabalho em MDF revestido a aço inox, dimensões 2040x615 mm (C45PXE / 3-2,0MT)
- Módulo fixo com 7 gavetas (C45PRO 2.0 M7)
- Módulo fixo com 5 gavetas (C45PRO 2.0 M5)
- 3 painéis de ferramentas perfurados (C45PRO 2.0 PF)
- 2 suporte de parede, tipo largo (C45PRO 2.0 SL)
- 2 suportes de parede, tipo estreito (C45PRO 2.0 SS)

181 kg

C45PRO 2.0 BPX-2,0

€ 2.870,00



1

045002042





## C45PRO 2.0 BPW-2,0

combinação de mobiliário modular para oficina C45PRO 2.0

Combinação inclui:

- Plano de trabalho em madeira laminada, dimensões 2040x615 mm (C45PWE / 3-2,0MT)
- Módulo fixo com 7 gavetas (C45PRO 2.0 M7)
- Módulo fixo com 5 gavetas (C45PRO 2.0 M5)
- 3 painéis de ferramentas perfurados (C45PRO 2.0 PF)
- 2 suportes de parede, tipo largo (C45PRO 2.0 SL)
- 2 suportes de parede, tipo estreito (C45PRO 2.0 SS)

165 kg

C45PRO 2.0 BPW-2,0

€ 2.770,00

1

045002052

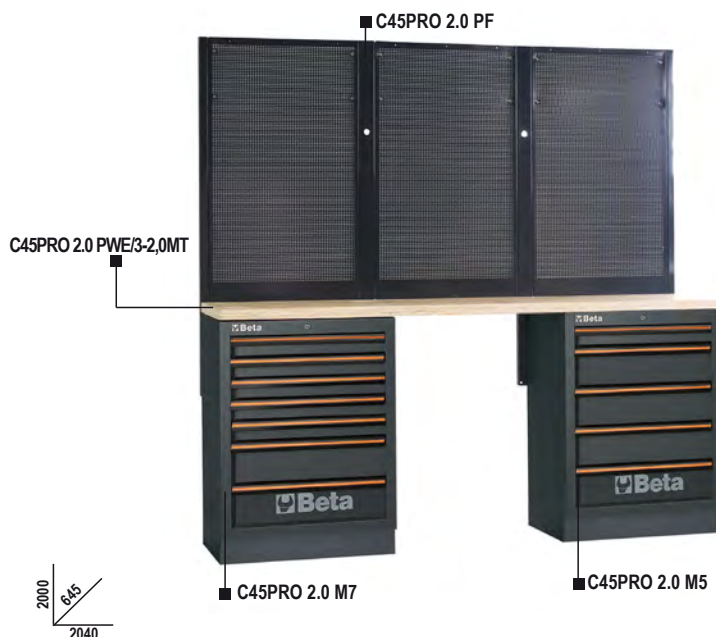

## C45PRO 2.0 BPX-1,3

combinação de mobiliário modular para oficina C45PRO 2.0

Combinação inclui:

- Plano de trabalho em MDF revestido a aço inox, dimensões 1360x615 mm (C45PXE / 2-1,3MT)
- Módulo fixo com 7 gavetas (C45PRO 2.0 M7)
- Módulo fixo com 5 gavetas (C45PRO 2.0 M5)
- 2 painéis de ferramentas perfurados (C45PRO 2.0 PF)
- 1 suporte de parede, tipo largo (C45PRO 2.0 SL)
- 2 suportes de parede, tipo estreito (C45PRO 2.0 SS)

155 kg

C45PRO 2.0 BPX-1,3

€ 2.540,00

1

045002041

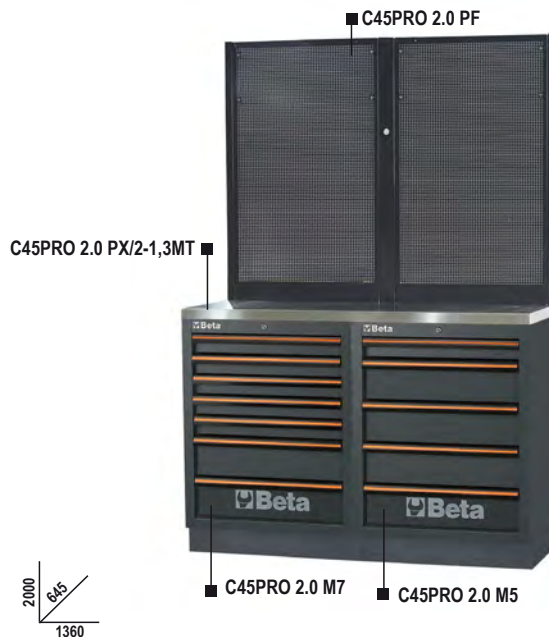

## C45PRO 2.0 BPW-1,3

combinação de mobiliário modular para oficina C45PRO 2.0

Combinação inclui:

- Superfície de trabalho em madeira laminada, dimensões 1360x615 mm (C45PWE / 2-1,3MT)
- Módulo fixo com 7 gavetas (C45PRO 2.0 M7)
- Módulo fixo com 5 gavetas (C45PRO 2.0 M5)
- 2 painéis de ferramentas perfurados (C45PRO 2.0 PF)
- 1 suporte de parede, tipo largo (C45PRO 2.0 SL)
- 2 suportes de parede, tipo estreito (C45PRO 2.0 SS)

145 kg

C45PRO 2.0 BPW-1,3

€ 2.430,00

1

045002051

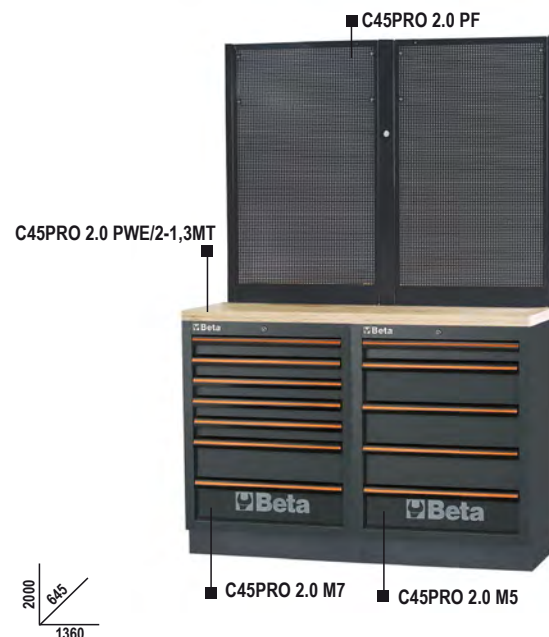

## C45PRO 2.0 BLX

bancada de trabalho para mobiliário modular para oficina C45PRO 2.0

- Plano de trabalho (1.360x615 mm) em MDF revestido a aço inox
- Estrutura em chapa
- Pés com regulação vertical
- Permite fixação de torno (1599P/150, opcional)
- Só deve ser utilizado como complemento de uma combinação de equipamentos e não como elemento único



C45PRO 2.0 BLX

€ 800,00 1 045002156

## C45PRO 2.0 BLW

bancada de trabalho para mobiliário modular para oficina C45PRO 2.0

- Plano de trabalho (1.360x615 mm) em madeira laminada
- Estrutura em chapa
- Pés com regulação vertical
- Permite fixação de torno (1599P/150, opcional)
- Só deve ser utilizado como complemento de uma combinação de equipamentos e não como elemento único



C45PRO 2.0 BLW

€ 730,00 1 045002157

## C45PRO 2.0 M7A/X

módulo fixo com 7 gavetas, para combinar com mobiliário de oficina C45PRO 2.0

- Plano de trabalho (1360x615 mm) em MDF revestido a aço inox
  - 1 gaveta (1248x406 mm) com guias de rolamentos de esferas
  - 6 gavetas (782x406 mm) com guias de rolamentos de esferas:
- 5 gavetas com 65 mm de altura  
1 gaveta com 145 mm de altura
- Fundo das gavetas protegido com tapete de borracha
  - Fechadura frontal centralizada
  - Pés com regulação vertical
  - Pode ser equipado com tabuleiros maleáveis
  - 1 compartimento de arrumação com prateleira e porta, dimensões interiores 504x424x597 mm
  - Permite fixação de torno (1599P/150, opcional)



81 kg

h	max
65 mm	25 kg
105 mm	40 kg
145 mm	30 kg

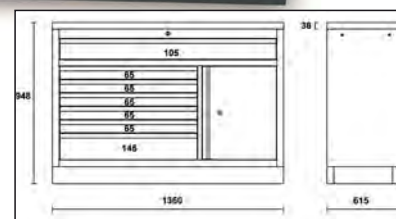

C45PRO 2.0 M7A/X

€ 1.950,00 1 045002161

## C45PRO 2.0 M7A/W

módulo fixo com 7 gavetas, para combinar com mobiliário de oficina C45PRO 2.0

- Plano de trabalho em madeira laminada, 1360x615 mm
- 1 gaveta (1248x406 mm) com guias de rolamentos de esferas
- 6 gavetas (782x406 mm) com guias de rolamentos de esferas:
- 5 gavetas com 65 mm de altura
- 1 gaveta com 145 mm de altura
- Fundo das gavetas protegido com tapete de borracha
- Fechadura frontal centralizada
- Pés com regulação vertical
- Pode ser equipado com tabuleiros maleáveis
- 1 compartimento de arrumação com prateleira e porta, dimensões interiores 504x424x597 mm
- Permite fixação de torno (1599P/150, opcional)

80 kg

C45PRO 2.0 M7A/W

€ 1.840,00



1



045002171



h	max
65 mm	25 kg
105 mm	40 kg
145 mm	30 kg

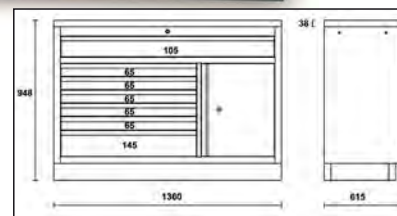

## C45PRO 2.0 MWS/X

carro Posto de Serviço com 7 gavetas e caixote do lixo integrado

- superfície de trabalho (1680 mm) em aço inox com revestimento MDF
- 1 gaveta (1248x406 mm) com guias de rolamentos de esferas
- 6 gavetas (782x406 mm) com guias de rolamentos de esferas:
- 5 gavetas 65 mm altura
- 1 gaveta 145 mm altura
- fundo das gavetas protegido com tapete de borracha
- pode ser equipado com bandejas em espuma
- 1 compartimento com prateleira e porta, dimensões interiores 504x424x597 mm
- caixote do lixo integrado
- compartimento para rolo de papel integrado
- 4 rodízios muito robustos, Ø 150 mm, 2 fixos e 2 direcionáveis com travão
- fechadura frontal centralizada
- permite instalação de torno (1599P/150, a encomendar separadamente)

126 kg

C45PRO 2.0 MWS/X

€ 1.870,00



1



045000181



h	max
65 mm	25 kg
105 mm	40 kg
145 mm	30 kg

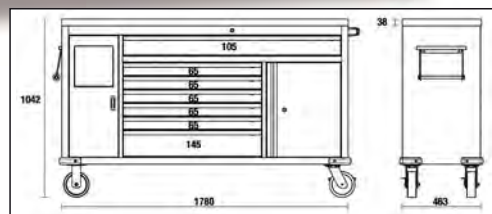

## C45PRO 2.0 MWS/W

carro Posto de Serviço com 7 gavetas e caixote do lixo integrado

- superfície de trabalho (1680 mm) em madeira laminada
- 1 gaveta (1248x406 mm) com guias de rolamentos de esferas
- 6 gavetas (782x406 mm) com guias de rolamentos de esferas:
- 5 gavetas 65 mm altura
- 1 gaveta 145 mm altura
- fundo das gavetas protegido com tapete de borracha
- pode ser equipado com bandejas em espuma
- 1 compartimento com prateleira e porta, dimensões interiores 504x424x597 mm
- caixote do lixo integrado
- compartimento para rolo de papel integrado
- 4 rodízios muito robustos, Ø 150 mm, 2 fixos e 2 direcionáveis com travão
- fechadura frontal centralizada
- permite instalação de torno (1599P/150, a encomendar separadamente)

122 kg

C45PRO 2.0 MWS/W

€ 1.820,00



1



045000191



h	max
65 mm	25 kg
105 mm	40 kg
145 mm	30 kg

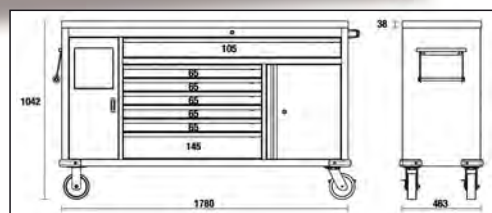



## C45PRO 2.0 CPF

par de painéis de ferramentas perfurados para carro C45PRO MWS

Fornecido com estrutura

Kit de 50 ganchos GPS incluído

11 kg

C45PRO 2.0 CPF

€ 242,00 1 045000195



## C45PRO 2.0 PXE/1-0,7MT

plano de trabalho em MDF revestido a aço inox, 680x615 mm, para bancada de trabalho, para combinar com mobiliário de oficina C45PRO 2.0

- Espessura: 38 mm
- Permite fixação de torno (1599P/150, opcional)
- Com 2 espaçadores e 2 amortecedores laterais

14 kg

C45PRO 2.0 PXE/1-0,7MT

€ 342,00 1 045002131



## C45PRO 2.0 PWE/1-0,7MT

plano de trabalho em madeira laminada, 680x615 mm, para bancada de trabalho, para combinar com mobiliário de oficina C45PRO 2.0

- Espessura: 38 mm
- Permite fixação de torno (1599P/150, opcional)
- Com 2 espaçadores e 2 amortecedores laterais

8 kg

C45PRO 2.0 PWE/1-0,7MT

€ 242,00 1 045002141



## C45PRO 2.0 PXE/2-1,3MT

plano de trabalho em MDF revestido a aço inox, 1360x615 mm, para bancada de trabalho, para combinar com mobiliário de oficina C45PRO 2.0

- Espessura: 38 mm
- Permite fixação de torno (1599P/150, opcional)
- Com 4 espaçadores e 2 amortecedores laterais

27 kg

C45PRO 2.0 PXE/2-1,3MT

€ 535,00 1 045002133



## C45PRO 2.0 PWE/2-1,3MT

plano de trabalho em madeira laminada, 1360x615 mm, para bancada de trabalho, para combinar com mobiliário de oficina C45PRO 2.0

- Espessura: 38 mm
- Permite fixação de torno (1599P/150, opcional)
- Com 4 espaçadores e 2 amortecedores laterais

17 kg

C45PRO 2.0 PWE/2-1,3MT

€ 430,00 1 045002143



## C45PRO 2.0 PXE/3-2,0MT

plano de trabalho em MDF revestido a aço inox 2040x615 mm, para bancada de trabalho, para combinar com mobiliário de oficina C45PRO 2.0

- Espessura: 38 mm
- Permite fixação de torno (1599P/150, opcional)
- Com 6 espaçadores e 2 amortecedores laterais

41,5 kg

C45PRO 2.0 PXE/3-2,0MT € 700,00 1 045002140



## C45PRO 2.0 PWE/3-2,0MT

plano de trabalho em madeira laminada, 2040x615 mm, para bancada de trabalho, para combinar com mobiliário de oficina C45PRO 2.0

- Espessura: 38 mm
- Permite fixação de torno (1599P/150, opcional)
- Com 6 espaçadores e 2 amortecedores laterais

26 kg

C45PRO 2.0 PWE/3-2,0MT € 595,00 1 045002150



## C45PRO 2.0 C5

carro de ferramentas com 5 gavetas, para combinar com mobiliário de oficina C45PRO 2.0

- Plano de trabalho em ABS com sistema anti-inclinação
- 5 gavetas (532x406 mm) com guias de rolamentos de esferas
- 4 rodízios direcionais, Ø 100 mm (2 com travão)
- Fundo das gavetas protegido com tapete de borracha
- Fechadura frontal centralizada
- Pode ser equipado com tabuleiros maleáveis
- Pegas integradas na estrutura para maior facilidade de manuseamento

46 kg

C45PRO 2.0 C5 € 905,00 1 045000226

h	max
65 mm	25 kg
145 mm	30 kg

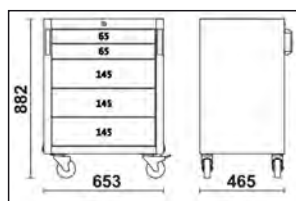
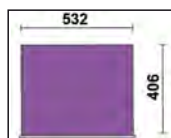

 **Beta**

## C45PRO 2.0 C7

carro de ferramentas com 7 gavetas, para combinar com mobiliário de oficina C45PRO 2.0

- Plano de trabalho em ABS com sistema anti-inclinação
- 7 gavetas (532x406 mm) com guias de rolamentos de esferas
- 4 rodas, Ø 100 mm (2 com travão)
- Fundo das gavetas protegido com tapete de borracha
- Fechadura frontal centralizada
- Pode ser equipado com tabuleiros maleáveis
- Pegas integradas na estrutura para maior facilidade de manuseamento

50 kg

C45PRO 2.0 C7

€ 1.000,00



1



045000228

h	max
65 mm	25 kg
145 mm	30 kg

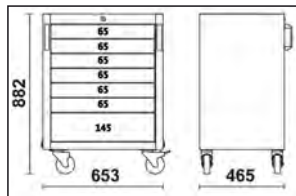
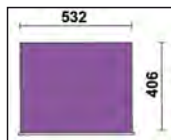

## C45PRO 2.0 M4

módulo fixo com 4 gavetas, para combinar com mobiliário de oficina C45PRO 2.0

- 4 gavetas (566x406 mm) com guias de rolamentos de esferas
- Fundo das gavetas protegido com tapete de borracha
- Fechadura frontal centralizada
- Pés com regulação vertical
- Pode ser equipado com tabuleiros maleáveis

46,7 kg

C45PRO 2.0 M4

€ 725,00



1



045000234

h	max
65 mm	25 kg
145 mm	30 kg
225 mm	30 kg

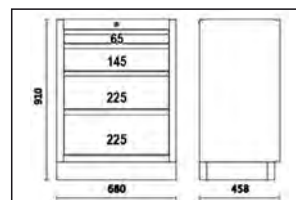
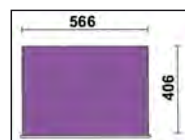

## C45PRO 2.0 M5

módulo fixo com 5 gavetas, para combinar com mobiliário de oficina C45PRO 2.0

- 5 gavetas (566x406 mm) com guias de rolamentos de esferas
- Fundo das gavetas protegido com tapete de borracha
- Fechadura frontal centralizada
- Pés com regulação vertical
- Pode ser equipado com tabuleiros maleáveis

49,3 kg

C45PRO 2.0 M5

€ 770,00



1



045000235

h	max
65 mm	25 kg
145 mm	30 kg

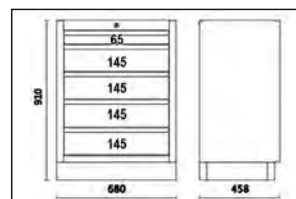
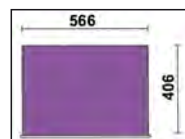



## C45PRO 2.0 M7

módulo fixo com 7 gavetas, para combinar com mobiliário de oficina C45PRO C45PRO 2.0

- 7 gavetas (566x406 mm) com guias de rolamentos de esferas
- Fundo das gavetas protegido com tapete de borracha
- Fechadura frontal centralizada
- Pés com regulação vertical
- Pode ser equipado com tabuleiros maleáveis

54,3 kg

h	max
65 mm	25 kg
145 mm	30 kg

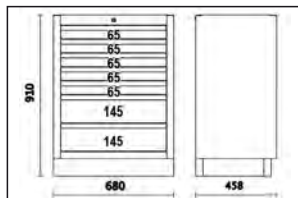
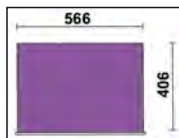

C45PRO 2.0 M7

€ 855,00 1 045000237

## C45PRO 2.0 M8

módulo fixo com 8 gavetas, para combinar com mobiliário de oficina C45PRO 2.0

- 8 gavetas (566x406 mm) com guias de rolamentos de esferas
- Fundo das gavetas protegido com tapete de borracha
- Fechadura frontal centralizada
- Pés com regulação vertical
- Pode ser equipado com tabuleiros maleáveis

56,8 kg

h	max
65 mm	25 kg
145 mm	30 kg

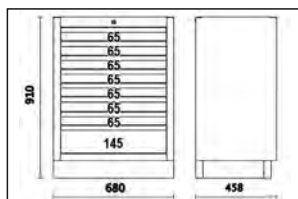
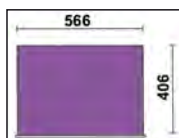

C45PRO 2.0 M8

€ 930,00 1 045000238

## C45PRO 2.0 MS

módulo de serviço fixo para combinar com mobiliário de oficina C45PRO 2.0

- Caixa de lixo integrada
- Porta-rolos de papel
- Pés com regulação vertical

37 kg

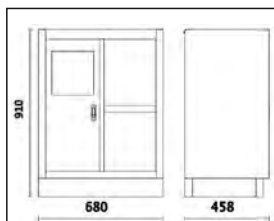

C45PRO 2.0 MS

€ 580,00 1 045000239

## C45PRO 2.0 RD/X

módulo de ecoponto fixo para combinar com equipamento para oficina C45PRO 2.0

- Bancada em MDF com revestimento aço inox (1.360x615 mm)
- Robusta estrutura em chapa com 4 caixotes com porta basculante para separação de resíduos
- Cada compartimento está Equipado com:  
um caixote de plástico amovível; capacidade: 25 l  
4 rodízios direcionáveis, Ø 60 mm
- Fornecido com kit de 4 fitas adesivas coloridas
- Pés reguláveis em altura

80 kg

C45PRO 2.0 RD/X

€ 2.000,00

1

045002241

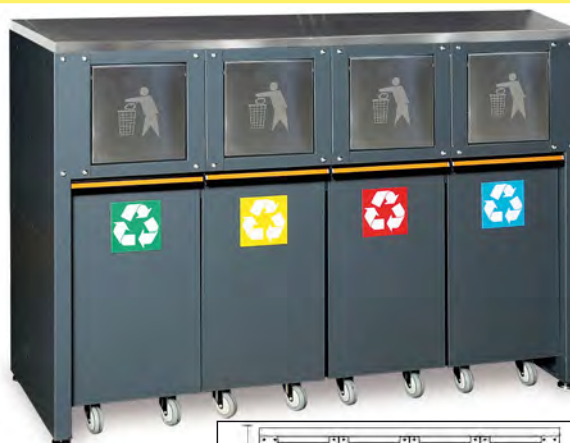

C45PRO 2.0 RD/X

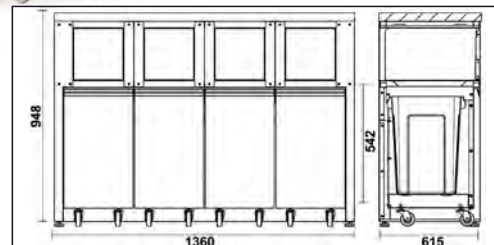

## C45PRO 2.0 RD/W

módulo de ecoponto fixo, para combinar com mobiliário de oficina C45PRO 2.0

- Plano de trabalho em madeira laminada (1360x615 mm)
- Estrutura robusta em chapa com 4 caixotes com porta basculante para separação de resíduos
- Cada recipiente está equipado com:  
um caixote de plástico amovível; capacidade: 25 litros  
4 rodízios direcionáveis, Ø 60 mm
- Fornecido com kit de 4 fitas adesivas coloridas
- Pés com regulação vertical

80 kg

C45PRO 2.0 RD/W

€ 1.890,00

1

045002240



C45PRO 2.0 RD/W

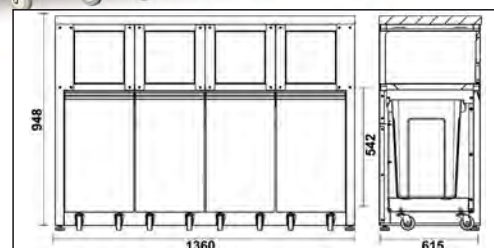

## C45PRO 2.0 MA

módulo fixo de duas portas para combinar com mobiliário de oficina C45PRO 2.0

- Com fechadura
- Prateleira com regulação vertical
- Dimensões interiores 670x420 mm
- Pés com regulação vertical

29,4 kg

C45PRO 2.0 MA

€ 430,00

1

045000232

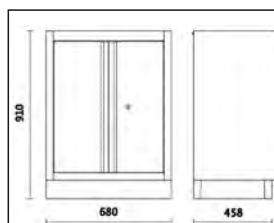

## C45PRO 2.0 MAL

módulo fixo, 1360 mm de comprimento, com duas portas em chapa, para combinar com mobiliário de oficina C45PRO 2.0

- Com fechadura
- Prateleira com regulação vertical
- Dimensões internas: 1355x420 mm
- Pés com regulação vertical

44,8 kg

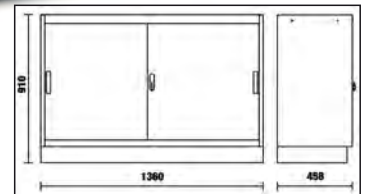

C45PRO 2.0 MAL

€ 760,00 1 045000229

## C45PRO 2.0 MAT

módulo fixo, 1360 mm de comprimento, com duas portas em policarbonato transparente, para combinar com mobiliário de oficina C45PRO 2.0

- Com fechadura
- Prateleira com regulação vertical
- Dimensões interiores: 1355x420 mm
- Pés com regulação vertical

44,1 kg

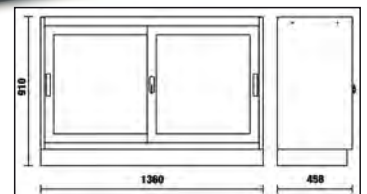

C45PRO 2.0 MAT

€ 830,00 1 045000230

## C45PRO 2.0 M3A

módulo fixo com 3 gavetas e duas portas, para combinar com mobiliário de oficina C45PRO 2.0

- 3 gavetas (566x406 mm) com guias de rolamentos de esferas
- Fundo das gavetas protegido com tapete de borracha
- Pode ser equipado com tabuleiros maleáveis
- Fechadura frontal centralizada
- Compartimento com porta dupla e fechadura (dimensões interiores 670x440 mm), completo com prateleira
- Pés com regulação vertical

44 kg

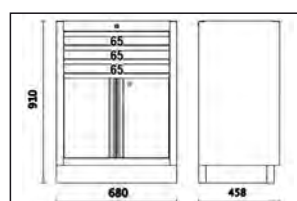
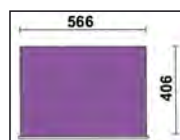
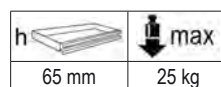

C45PRO 2.0 M3A

€ 745,00 1 045000231



## C45PRO 2.0 MRE

módulo fixo para carregar ferramentas elétricas, para mobiliário modular para oficina C45PRO 2.0

- Compartimento lateral amovível, com guias de esferas, para alojar ferramentas elétricas
- Compartimento lateral fixo com porta e fechadura para carregadores e baterias, equipado com: prateleira interna regulável em altura
- casquilhos de cabos protegidos com borracha
- aberturas de ventilação
- 1 gaveta (256x400x190 mm), com guias de esferas
- Fecho centralizado à frente
- Pés com regulação vertical

57 kg

C45PRO 2.0 MRE

€ 705,00 1 045000242

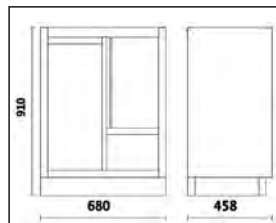

## C45PRO 2.0 ML

módulo fixo com lavatório, para combinar com mobiliário de oficina C45PRO 2.0

Especificações técnicas:

- Lavatório em aço inox.
- Fornecido com:
  - 1 torneira misturadora
  - 1 unidade de drenagem
  - 1 tampa do ralo
  - 1 tampa de filtro
  - 1 dispensador de sabão

Módulo fixo de duas portas com fechadura:

- Dimensões interiores úteis 600x603x416 mm
- Pés com regulação vertical

44 kg

C45PRO 2.0 ML

€ 1.250,00 1 045002233

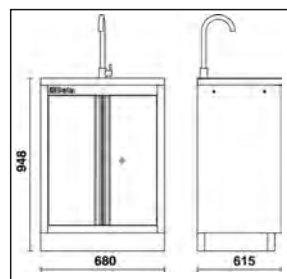

## C45PRO 2.0 ACT

módulo fixo com 3 gavetas e 2 enroladores, para combinar com mobiliário de oficina C45PRO 2.0

- 3 gavetas (566x406 mm) com guias de rolamentos de esferas
- Fundo das gavetas protegido com tapete de borracha
- Fechadura frontal centralizada
- Pés com regulação vertical

Fornecido com:

- 1 enrolador de tubo de ar comprimido ou água fria, 8 mm, comprimento 10 m, artigo 1900S 8x10
- 1 enrolador de cabo elétrico, comprimento 15 m, artigo 1844 15-H05

50,7 kg

C45PRO 2.0 ACT

€ 1.110,00 1 045000247



h	max
65 mm	25 kg
145 mm	30 kg

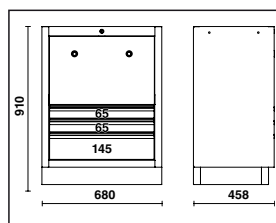
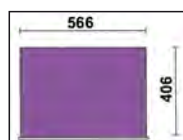

## C45PRO 2.0 TC

módulo fixo para enrolador com 3 gavetas, para combinar com mobiliário de oficina C45PRO 2.0, vazio

- 3 gavetas (566x406 mm) com guias de rolamentos de esferas;
- Fundo das gavetas protegido com tapete de borracha;
- Fechadura frontal centralizada;
- Pés com regulação vertical;

- Pode ser equipado com 2 enroladores, a escolher de entre os seguintes:
  - 2 enroladores de tubo de ar comprimido ou água fria, 8 mm, comprimento 10 m artigo 1900S 8x10
  - 2 enroladores de cabo elétrico, a escolher de entre os seguintes artigos: 1843 15-H05, 1844 10-H05, 1844 15-H05, 1844 15-H07, 1845 12-H05, 1846 10-H05, 1846 10-H07 e 1846 15-H05
  - 1 enrolador de tubo de ar comprimido ou água fria, 8 mm, comprimento 10 m artigo 1900S 8x10 e 1 enrolador de cabo elétrico, a escolher de entre os artigos acima referidos

h		
	65 mm	25 kg
	145 mm	30 kg

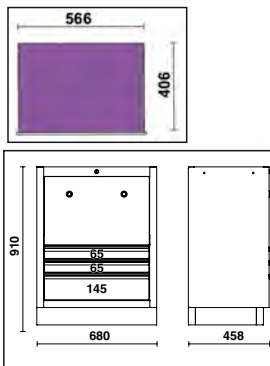

40,9 kg

C45PRO 2.0 TC € 675,00 1 045000249

## C45PRO 2.0 T3

carro de ferramentas com 3 prateleiras, para combinar com mobiliário de oficina C45PRO 2.0

- 4 rodízios direcionáveis, Ø 100 mm (um com travão)
- Capacidade de carga estática: 200 kg (distribuídos pelas 3 prateleiras)

19,2 kg

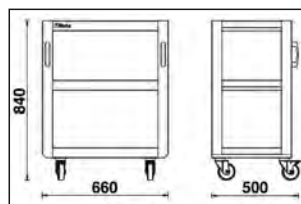

C45PRO 2.0 T3 € 336,00 1 045000250

## C45PRO 2.0 SS

suporte de parede, tipo estreito, para combinar com mobiliário de oficina C45PRO 2.0

- Dimensões: 1420x32.5x30 mm

1,5 kg



C45PRO 2.0 SS € 32,50 1 045000333

## C45PRO 2.0 SL

suporte de parede, tipo largo, para combinar com mobiliário de oficina C45PRO 2.0

- Dimensões: 1420x65x30 mm

2 kg



C45PRO 2.0 SL € 43,50 1 045000366

## C45PRO 2.0 PAS

sistema de parede para ferramentas, para combinar com mobiliário de oficina C45PRO 2.0

- Persiana em alumínio, regulação em altura, com fechadura
- Dois painéis perfurados amovíveis
- Pode ser utilizado em combinação com a bancada de trabalho de 1,3 m de comprimento
- Kit de 50 ganchos GPS incluído

📦 49,7 kg

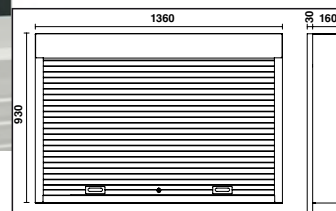

C45PRO 2.0 PAS

€ 1.090,00 1 045000290

## C45PRO 2.0 PF

painel de ferramentas perfurado para combinar com mobiliário de oficina C45PRO 2.0

- Dimensões 1052x614,5x24 mm

📦 5,3 kg



C45PRO 2.0 PF

€ 135,00 1 045000313

## C45PRO 2.0 PFE

painel de ferramentas perfurado para combinar com mobiliário de oficina C45PRO 2.0

- Dimensões 1052x614,5x24 mm
- Pode ser equipado com 1 tomada elétrica (não incluída)

📦 5,3 kg



C45PRO 2.0 PFE

€ 129,00 1 045000312

## C45PRO 2.0 MP

prateleira em aço para painéis de ferramentas perfurados, para combinar com mobiliário de oficina C45PRO 2.0

Dimensões: 614x160x80 mm

📦 2,1 kg



C45PRO 2.0 MP

€ 58,00 1 045000315



## C45PRO 2.0 CORNER/X

canto completo autónomo para combinar com mobiliário de oficina C45PRO 2.0

- Armário de canto suspenso com fechadura e 2 compartimentos de armazenamento
- 2 painéis de ferramentas perfurados (1052x860 mm)
- Bancada de canto em MDF revestida a aço inox (1018x1018 mm)
- Módulo de canto inferior com grande compartimento de armazenamento
- Pés com regulação vertical

127 kg

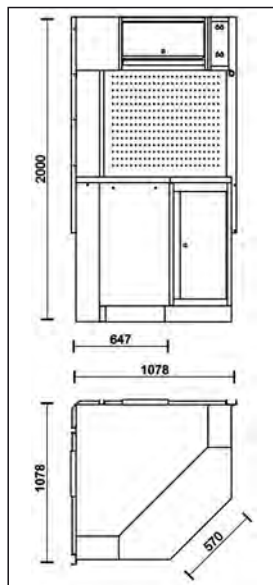

C45PRO 2.0 CORNER/X

€ 2.550,00 1 045002401

## C45PRO 2.0 CORNER/W

canto completo independente para combinar com mobiliário de oficina C45PRO 2.0

- Armário de canto suspenso com fechadura e 2 compartimentos de armazenamento
- 2 painéis de ferramentas perfurados (1052x860 mm)
- Bancada de canto em madeira laminada (1018x1018 mm)
- Módulo de canto inferior com grande compartimento de armazenamento
- Pés com regulação vertical

119 kg

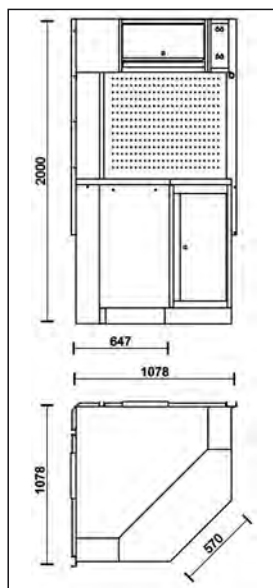

C45PRO 2.0 CORNER/W

€ 2.480,00 1 045002411



**Beta**

## C45PRO 2.0 CAI/X

módulo de canto inferior, para combinar com mobiliário de oficina C45PRO 2.0

- Plano de trabalho em MDF revestido a aço inox, (1018x1018 mm)
- Módulo de canto fixo com grande compartimento de armazenamento
- Pés com regulação vertical

77 kg

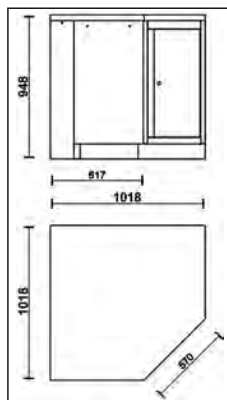

C45PRO 2.0 CAI/X

€ 1.380,00 1 045002412

## C45PRO 2.0 CAI/W

módulo de canto inferior, para combinar com mobiliário de oficina C45PRO 2.0

- Plano de trabalho em madeira laminada (1018x1018 mm)
- Módulo de canto fixo com grande compartimento de armazenamento
- Pés com regulação vertical

69 kg

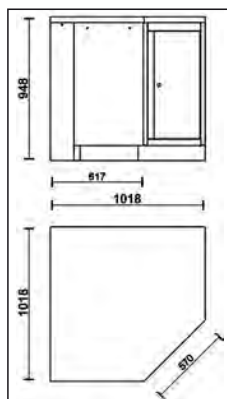

C45PRO 2.0 CAI/W

€ 1.300,00 1 045002402

## C45PRO 2.0 PM

armário suspenso para combinar com mobiliário de oficina C45PRO 2.0

- Comprimento: 680 mm
- Com amortecedores a gás, para fácil utilização da porta
- Com fechadura

10 kg

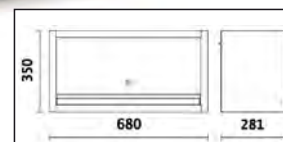

C45PRO 2.0 PM

€ 249,00 1 045000302

## SSPE

suporte para colocação sob o armário de ferramentas elétricas

- Para utilização apenas sob o armário suspenso C45PRO 2.0 PM (equipamento de oficina C45PRO 2.0)
- Com 5 compartimentos convenientes para ferramentas elétricas
- Dimensões: 680 x 280 x 150 mm

6 kg



SSPE

€ 108,00 1 088880482

## C45PRO 2.0 PML

armário suspenso, longo, para combinar com mobiliário de oficina C45PRO 2.0

- Comprimento: 1360 mm
- Com amortecedores a gás, para fácil utilização da porta
- Com fechadura

17 kg

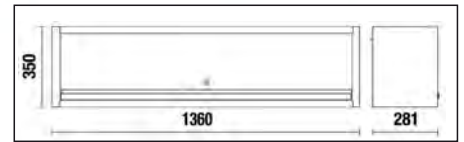

C45PRO 2.0 PML

€ 445,00 1 045000303

## C45PRO 2.0 AS1

armário de ferramentas em chapa com uma porta e suporte, para combinar com mobiliário de oficina C45PRO 2.0

- 4 prateleiras amovíveis com regulação vertical
- Varão para vestuário sob a primeira prateleira
- Com fechadura
- Porta em chapa pode ser instalada para abertura à direita ou à esquerda
- Dimensões internas: 590x430 mm
- Pés com regulação vertical

57,5 kg

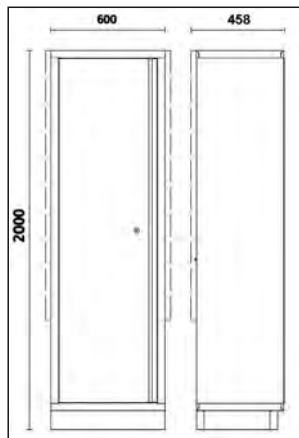

C45PRO 2.0 AS1

€ 885,00 1 045000451

## C45PRO 2.0 A1/R600

prateleira interior para armário C45PRO AS1

2,5 kg



C45PRO 2.0 A1/R600

€ 54,00 1 045000466

## C45PRO 2.0 A1/RB600

prateleira interior para armário C45PRO 2.0 AS1, com varão para vestuário

3,3 kg

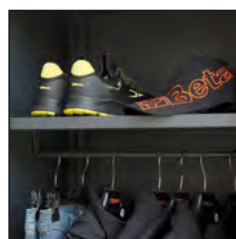

C45PRO 2.0 A1/RB600

€ 62,00 1 045000467



## C45PRO 2.0 AS2

armário de ferramentas de chapa, de duas portas com suporte, para combinar com mobiliário de oficina C45PRO 2.0

- 4 prateleiras amovíveis com regulação vertical
- Com fechadura
- Porta em chapa pode ser instalada para abertura à direita ou à esquerda
- Dimensões internas: 910x430 mm
- Pés com regulação vertical

80 kg

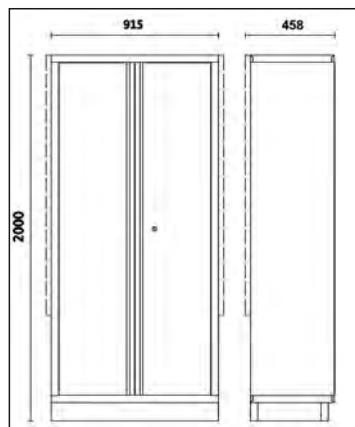

C45PRO 2.0 AS2

€ 1.180,00 1 045000481

## C45PRO 2.0 AS2/3C

armário de ferramentas com duas portas em chapa, 3 gavetas e suporte, para mobiliário modular para oficina C45PRO 2.0

- 4 prateleiras amovíveis com regulação vertical
- Fornecido com módulo de 3 gavetas (681x360 mm)
- Fechadura frontal
- Porta de chapa pode ser instalada com abertura à direita ou à esquerda
- Dimensões interiores: 910x430 mm
- Pés com regulação vertical

100,5 kg

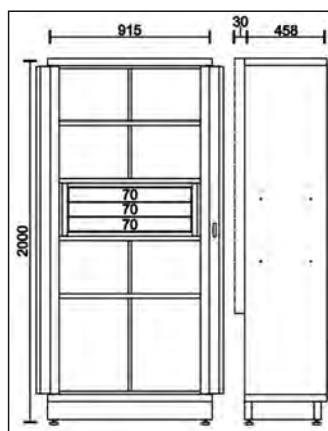
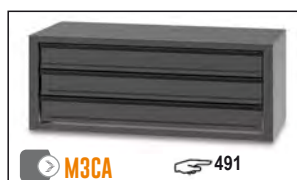

C45PRO 2.0 AS2/3C

€ 1.460,00 1 045000482

## C45PRO 2.0 A2/R915

Prateleira interior para armário de ferramentas C45PRO 2.0 AS2

4,5 kg

50 kg

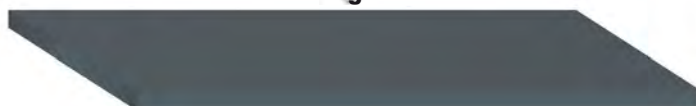

C45PRO 2.0 A2/R915

€ 67,00 1 045000496

## C45STR

fita adesiva colorida para combinar com mobiliário de oficina C45PRO 2.0

- Permite a personalização da cor das inserções horizontais e verticais no equipamento para oficina C45PRO 2.0



	L m	€		
C45STR-O/2011	30	69,50	1	045000911
C45STR-G/9006	25	63,00	1	045000912
C45STR-R/3000	25	63,00	1	045000913
C45STR-B/5015	25	63,00	1	045000914
C45STR-Y/1023	25	63,00	1	045000915
C45STR-V/6029	25	63,00	1	045000916

## S4CB

estante, 4 prateleiras básicas

Um elemento indispensável para otimizar e gerir eficazmente produtos e ferramentas em armazéns, oficinas, escritórios e pontos de venda. Fabricada em chapa de aço resistente, é ideal para acomodar vários tipos de mercadorias.

- Capacidade de carga de cada prateleira: 250 kg • Capacidade de carga total: 1.000 kg
- Pode ser fixada ao chão

82 kg



	mm	€		
S4CB	1552x600x1803mm	735,00	1	088880490

## S4CA

estante, 4 prateleiras básicas e prateleiras adicionais

As prateleiras adicionais prolongam as prateleiras básicas para aumentar o espaço de arrumação. Fabricada em chapa de aço resistente, é ideal para acomodar vários tipos de mercadorias.

- Capacidade de carga de cada prateleira: 250 kg • Capacidade de carga total: 1.000 kg
- Pode ser fixada ao chão

72 kg



	mm	€		
S4CA	1552x600x1803mm	625,00	1	088880495



# ACESSÓRIOS RSC55 - RSC50 2.0 - C45PRO 2.0

		5000 RSC50 2.0/PLED-ST	5000 RSC50 2.0/PLED	5000 RSC50 2.0/ASL	5000 RSC50 2.0/CTR
	A	1x	-	1x	-
	B	-	1x	1x	1x
	A	1x	1x	1x	-
	B	-	2x	1x	1x
	A	1x	2x	1x	-
	B	-	3x	1x	1x

## 5000 RSC50 2.0/PLEDC

perfil de alumínio com fita LED, para combinar com mobiliário de oficina

Para aplicar sob bancadas, sob/em armários suspensos, sob prateleiras e resguardos lineares/de canto, para iluminar áreas de trabalho.

Especificações:

- Fita LED IP20 de 6,5 W; comprimento: 50 cm
- Fornecida com cabos
- Fixação fácil através de ímanes



80 g

5000 RSC50 2.0/PLEDC

€ 42,00 1 050001712

## 5000 RSC50 2.0/PLED-ST

perfil em alumínio com fita LED e interruptor SOFT TOUCH, para combinar com mobiliário de oficina

Aplicar sob bancadas, sob/em armários suspensos, sob prateleiras e resguardos lineares/de canto, para iluminar áreas de trabalho.

Especificações:

- Fita LED IP20 de 6,5W; comprimento: 50 cm
- Interruptor SOFT TOUCH para ligar e ajustar a potência da iluminação
- Fornecido com cabos
- Fixação fácil através de ímãs



80 g

5000 RSC50 2.0/PLED-ST

€ 45,00 1 050001715

## 5000 RSC50 2.0/ASL

fonte de alimentação para fita LED, para combinar com mobiliário de oficina

Especificações:

- Fonte de alimentação 24VDC 22W
- Pode fornecer energia até 3 fitas LED de 6.5 W



210 g

5000 RSC50 2.0/ASL

€ 35,00 1 050001716



## 5000 RSC50 2.0/CTR

Controlador de fita LED, com controlo remoto RF, para combinar com mobiliário de oficina

Apenas para utilização com fita LED artigo 5000 RSC50 2.0/PLEDC

Kit inclui:

1 mini recetor

1 controlo remoto RF sem fio

Especificações do mini recetor:

Tensão de entrada: 5V -24VDC

Corrente nominal de saída: 5A

Pico corrente de saída: 12A

Temperatura de funcionamento: -20 ÷ +35 °C

Especificações do controlo remoto RF:

Botão ON/OFF

Botão BRIGHT +/-: permite o ajuste manual da luminosidade

Botão 25%/50%/100%: permite o ajuste automático da luminosidade

Bateria: 3V CR2025 (incluída)

Dimensões: 86x40x7 mm

Recursos integrados:

- Memória
- Modo (luminosidade manual/automático)
- Ajuste de luminosidade



25 g

5000 RSC50 2.0/CTR

€



1



050001721

## CPMB/3C

recipientes para peças pequenas com 3 gavetas para bancadas de trabalho

- Estrutura externa em PP
- Gavetas para peças pequenas em PET
- Empilháveis

Especificações das gavetas:

- Dimensões do interior da gaveta: 160x107x105h mm
- Inquebrável
- Transparência de efeito vidro inalterada ao longo do tempo
- Antirriscos
- Resistente a óleo, ácidos e produtos químicos agressivos
- Também adequado para utilização em produtos alimentares



2,3 kg

CPMB/3C

€



1



088880443

## KIT 6VC/3C

kit de 6 gavetas amovíveis para recipientes para peças pequenas CPMB/3C

1,1 kg



6x



KIT 6VC/3C

€



1



088880453

## CPMB/5C

recipientes para peças pequenas com 5 gavetas para bancadas de trabalho

- Estrutura externa em PP
- Gavetas para peças pequenas em PET
- Empilháveis

Especificações das gavetas:

- Dimensões do interior da gaveta: 90x86x62h mm
- Inquebrável
- Transparência de efeito vidro inalterada ao longo do tempo
- Antirriscos
- Resistente a óleo, ácidos e produtos químicos agressivos
- Também adequado para utilização em produtos alimentares

1,7 kg

CPMB/5C € 70,00 1 088880445



## KIT 10VC/5C

kit de 10 gavetas amovíveis para recipientes para peças pequenas CPMB/5C

800 g

KIT 10VC/5C € 30,00 1 088880455



10x



## PM/5C

suporte de parede com 5 gavetas em plástico para peças de pequenas dimensões

- Dimensões do interior da gaveta: 95x120 mm
- Podem ser utilizados com os painéis de ferramentas de parede: C45PRO, RSC50 2.0 e RSC55 2.0

2,7 kg

PM/5C € 123,00 1 088880450



165  
140  
600



## PM/6C

suporte de parede com 6 gavetas em plástico para peças de pequenas dimensões

- Dimensões do interior da gaveta: 80x60 mm
- Podem ser utilizados com os painéis de ferramentas de parede C45PRO 2.0, RSC50 2.0 e RSC55

970 g

PM/6C € 94,50 1 088880440



115  
85  
600



## CP

suporte de parede em aço para sprays

- Pode ser utilizado em painéis de ferramentas de parede
- Fornecido com 2 suportes

533 g

CP € 119,00 1 088880470



115  
85  
280



## SPC

suporte para computador

- Compatível com os sistemas RSC55, RSC50 2.0 e C45PRO 2.0
- Dimensões 398x243x138 mm

1,5 kg

SPC

€ 96,00 1 088880480



## SP5S

suporte de parede com 5 compartimentos

- Em chapa metálica
- 5 compartimentos de ferramentas variáveis em altura
- Dimensões: 260x60x290 mm

1,8 kg

SP5S

€ 119,00 1 088880475



## M3CA

módulo de 3 gavetas para armários de ferramentas de duas portas  
C45PRO AS2 e RSC50 A2

- 3 gavetas totalmente amovíveis (661x360 mm), com guias de rolamentos de esferas
- Altura das gavetas: 78 mm
- Fundo das gavetas protegido com tapete de borracha
- Fornecido com kit de montagem

20,5 kg

M3CA

€ 295,00 1 088880485



# Beta



**CARROS**

**FERRAMENTAS SORTIDAS**

**MÓDULOS**

			Nr. peças	CARROS																
				RSC22	RSC23	RSC23C	RSC23T	RSC24/5	RSC24/6 - RSC24A/6 - C37/6 - C39/6	RSC24/7 - RSC24A/7 - RSC24AXL/7 RSC24AXLP/7 - RSC24AXL - RSC24L/7 RSC24L-CAB - C37/7 - C37A/7 - C39/7	RSC24/8 - RSC24A/8 - RSC24AXL/8 C37/8 - C39/8	RSC24AXL/9	C4 - C5 - C6T - C9MT	C25	C27S	RSC28	C30M			
sem suportes	5902MT	Máquinas de movimentação de terras	106	529	529	529														
	5902MT/AS	Máquinas de movimentação de terras	99	530	530	530														
	5902VI	Para a manutenção industrial	107	494	494		494							494	494				494	
	5904VG/3	Automóvel	132					533	533	533	533									
	5905VG/1	Automóvel	94											536					536	
	5905VG/2	Automóvel	118											537						
	5910VI/3	Para a manutenção industrial	297																498	
com suportes	5954VG	Automóvel	138																542	
	5954VI	Para a manutenção industrial	133																	
	5957U-P	Utilização universal	133																	
	5957VG	Automóvel	174		543		543	543												
	5957VI	Para a manutenção industrial	162			501		501	501											
	5958U	Utilização universal	85		516		516													
módulos soft específicos	5904VG/2M	Automóvel	170				531	531	531	531	531	531							531	
	5904VU/1M	Utilização universal	90				503	503	503	503	503	503							503	
	5904VU/2M	Utilização universal	144				504	504	504	504	504	504							504	
	5927VU/M	Utilização universal	108	514	514	514								501						
	5935ET/1MB	Electrotechnical	96																	
	5935VG/1MB	Automóvel	98																	
	5935VI/2MB	Para a manutenção industrial	133																	
	5945VUM	Utilização universal	231																	
	5988H/7M	Automóvel	333										519	519					519	
	5988L/4M	Automóvel	273					520	520	520	520	520	520							
	5980U/BIKE-M	Reparação de bicicletas	106				518		518	518	518	518	518						518	
	5988U6/M	Utilização universal	214								521	521	521						521	
	5988U/7M	Utilização universal	215				510	510	510	510	510	510	510						510	
	5988 VHB-MQ	Electrotechnical	66				525	525	525	525	525	525	525						525	
	5989 VEM	Automóvel	66				528	528	528	528	528	528	528						528	
	tabuleiros maleáveis	5904VI/1T	Para a manutenção industrial	98				494	494	494	494	494	494							494
		5904VI/2T	Para a manutenção industrial	153				497			497	497	497							497
5904VI/3T		Para a manutenção industrial	144							495	495	495							495	
5904VG/2T		Automóvel	99				532	532	532	532	532	532							532	
5904VG/3T		Automóvel	102				534	534	534	534	534	534							534	
5904VG/5T		Automóvel	153				535		535	535	535	535							535	
5904VU/2T		Utilização universal	104				505	505	505	505	505	505							505	
5904VU/3T		Utilização universal	146				506	506	506	506	506	506	506						506	
5904VU/4T		Utilização universal	197				507	507	507	507	507	507	507							
5908VG/2T		Automóvel	214																538	
5908VI/2T		Para a manutenção industrial	232								496	496							496	
5908VU/2T		Utilização universal	161				508		508	508	508	508	508						508	
5910VI/3T		Para a manutenção industrial	261																	499

**CARROS**

**FERRAMENTAS SORTIDAS**

**MÓDULOS**

**Nr. peças**

			C35	C39MD - C39SM	C39T	C45PRO 2.0	RSC51	C54S - RSC55C	RSC55	RSC55PS - RSC55PSE	RSC50 2.0	C57SA - C57SD - C57SB C57SC - C57SP	C58P - C45PRO PAS	C59A - C59C	C59B	C59C
sem suportes	5902MT	Máquinas de movimentação de terras	106		529											
	5902MT/AS	Máquinas de movimentação de terras	99		530											
	5902VI	Para a manutenção industrial	107													
	5904VG/3	Automóvel	132						533		533	533		533	533	533
	5905VG/1	Automóvel	94													
	5905VG/2	Automóvel	118													
	5910VI/3	Para a manutenção industrial	297													
com suportes	5954VG	Automóvel	138					542								
	5954VI	Para a manutenção industrial	133					502	502							
	5957U-P	Utilização universal	133							515	515	515				
	5957VG	Automóvel	174							543		543				
	5957VI	Para a manutenção industrial	162									501				501
	5958U	Utilização universal	85			516			516	516	516		516			
módulos soft específicos	5904VG/2M	Automóvel	170	531	531				531		531	531		531	531	531
	5904VU/1M	Utilização universal	90	503	503	503			503		503	503		503	503	503
	5904VU/2M	Utilização universal	144	504	504				504		504	504		504	504	504
	5927VU/M	Utilização universal	108													
	5935ET/1MB	Electrotechnical	96	522												
	5935VG/1MB	Automóvel	98	539												
	5935VI/2MB	Para a manutenção industrial	133	500												
	5945VUM	Utilização universal	231			541										
	5988H/7M	Automóvel	333						519		519				519	519
	5988L/4M	Automóvel	273	520	520				520		520	520		520	520	520
	5980U/BIKE-M	Reparação de bicicletas	106								518	518			518	518
	5988U6/M	Utilização universal	214	521					521		521				521	521
	5988U/7M	Utilização universal	215	510					510		510	510		510	510	510
	5988 VHB-MQ	Electrotechnical	66	525	525	525			525			525		525	525	525
	5989 VEM	Automóvel	66								528				528	
tabuleiros maleáveis	5904VI/1T	Para a manutenção industrial	98	494	494	494			494		494	494		494	494	494
	5904VI/2T	Para a manutenção industrial	153	497					497		497	497		497	497	497
	5904VI/3T	Para a manutenção industrial	144	495					495		495	495			495	495
	5904VG/2T	Automóvel	99	532	532	532			532		532	532		532	532	532
	5904VG/3T	Automóvel	102	534	534				534		534	534		534	534	534
	5904VG/5T	Automóvel	153	535					535		535	535		535	535	535
	5904VU/2T	Utilização universal	104	505	505				505		505	505		505	505	505
	5904VU/3T	Utilização universal	146	506	506				506		506	506		506	506	506
	5904VU/4T	Utilização universal	197	507	507				507		507	507		507	507	507
	5908VG/2T	Automóvel	214													
	5908VI/2T	Para a manutenção industrial	232								496				496	496
	5908VU/2T	Utilização universal	161	508					508		508	508		508	508	508
	5910VI/3T	Para a manutenção industrial	261													



## 5902VI

jogo de 107 ferramentas

### ► Manutenção industrial

#### Nr. Peças/Descrição

- 6 saca-troços Ø 2 - 3 - 4 - 5 - 6 - 8 mm
- 1 punção de bico Ø 3 mm
- 1 escopros planos 200 mm
- 26 chaves mistas 6÷32 mm
- 12 chaves de bocas 6x7 - 8x9 - 10x11 - 12x13 - 14x15 - 16x17 - 18x19 - 20x22 - 21x23 - 24x26 - 25x28 - 30x32 mm
- 9 chaves macho hexagonal Ø 1,5 - 2 - 2,5 - 3 - 4 - 5 - 6 - 8 - 10 mm
- 1 Chave ajustável 300 mm
- 13 chaves de caixa sextavadas, quadra de 1/2" Ø 10÷22 mm
- 1 extensão com quadras macho e fêmea de 1/2" 125 mm
- 1 extensão com quadras macho e fêmea de 1/2" 255 mm
- 1 cardan com quadras macho e fêmea de 1/2"
- 1 cabo T correção, quadra de 1/2"
- 1 roquete reversível, quadra de 1/2" ®
- 1 alicate de charneira fechada 250 mm
- 1 alicate de pressão 240 mm
- 1 alicates de corte diagonal para serviços pesados, punhos em bi-matéria, acabamento industrial 160 mm
- 1 tesoura articulada, lâminas direitas 250 mm
- 1 tesoura de electricista 147 mm
- 1 alicate combinado para trabalhos pesados, punhos bi-material, acabamento industrial 180 mm
- 1 alicate de pontas semi-redondas com estrias, extra-longas, punhos bi-material, acabamento industrial 160 mm
- 8 chaves para parafusos de perfil de fenda ● 2,5x50 - 3x75 - 3,5x100 - 4x125 - 5,5x125 - 6,5x150 - 8x200 - 10x200 mm
- 4 chaves para parafusos de perfil Phillips® ⚡ PH0x60 - PH1x80 - PH2x100 - PH3x150 mm
- 1 martelo para mecânico, tipo alemão 500 g
- 1 martelo anti - recuo com batentes plásticos intermutáveis Ø 40 mm
- 1 riscador, extremidades em carboneto de tungsténio
- 1 fita métrica 5 m
- 1 apalpa - folgas
- 5 jogo de 5 limas meia-murça, com punhos 200 mm
- 1 serrote com folha de serra bi-metálica
- 1 Lata de óleo de pressão 300 cc
- 1 x - acto com lâmina divisível de 18 mm 170 mm
- 1 lanterna LED de inspeção

Refa. Nr.
31
32
35
42/S26
55/S12
96N/SC9
111E
920A/SB13
920/21
920/22
920/25
920/42
920/55
1048N
1052
1084GBM
1122
1128BMX
1150GBM
1166GBM
1260
1262
1370
1392
1688A
1692
1708/20
1719BMA...S5
1726BM
1751N
1771BM
1838SW

5902VI € 1.930,00 059021060

Sortido recomendado em combinação com RSC22 - RSC23 - RSC23T - C25 - C27S



T80 T05 T06



T153 T138 T145 T236



T234 T33 T208 T68

## 5904VI/1T

jogo de 98 ferramentas

### ► Manutenção industrial

#### Nr. Peças/Descrição

- 19 chaves de caixa sextavadas, quadra de 1/2" Ø 10÷24 - 26 - 27 - 30 - 32 mm
- 5 chaves de caixa com ponta hexagonal, quadra de 1/2" Ø 5 - 6 - 8 - 10 - 12 mm
- 1 extensão com quadras macho e fêmea de 1/2" 125 mm
- 1 extensão com quadras macho e fêmea de 1/2" 255 mm
- 1 cardan com quadras macho e fêmea de 1/2"
- 1 cabo T correção, quadra de 1/2"
- 1 roquete reversível, quadra de 1/2" ®
- 16 chaves mistas, boca-luneta 6÷21 mm
- 5 chaves mistas, boca-luneta 22-24-27-30-32 mm
- 1 alicate de charneira fechada 250 mm
- 1 alicate de pressão 240 mm
- 1 Alicates de corte diagonal para trabalhos pesados 160 mm
- 1 alicate de pontas semi-redondas extra-longas 180 mm
- 1 Alicates de pontas semirredondas extralongas 160 mm
- 1 alicates de freios interiores com pontas direitas 180 mm
- 1 alicates de freios interiores com pontas curvas 170 mm
- 1 alicates de freios exteriores com pontas direitas 175 mm
- 1 alicates de freios exteriores com pontas curvas 175 mm
- 2 escopros planos 100 - 200 mm
- 5 limas perfis diversos 200 mm
- 1 martelo para mecânico, tipo alemão 300 g
- 1 martelo com batentes plásticos intermutáveis Ø 35 mm
- 8 chaves de bocas 6x7 - 8x9 - 10x11 - 12x13 - 14x15 - 16x17 - 18x19 - 20x22 mm
- 9 chaves macho hexagonal Ø 1,5 - 2 - 2,5 - 3 - 4 - 5 - 6 - 8 - 10 mm
- 4 chaves para parafusos de perfil de fenda ● 3x75 - 4x100 - 5,5x150 - 6,5x150 mm
- 3 chaves para parafusos de perfil Phillips® ⚡ PH0x60 - PH1x80 - PH2x100 mm
- 6 chaves em T com três extremidades macho hexagonal Ø 2,5 - 3 - 4 - 5 - 6 - 8 mm

Refa. Nr.	TR
920A	T80
920ME	T80
920/21	T80
920/22	T80
920/25	T80
920/42	T80
920/55	T80
42	T05
42	T06
1048N	T153
1052	T153
1084	T138
1150	T138
1166	T138
1032	T145
1034	T145
1036	T145
1038	T145
35	T234
1719BMA8/S5	T236
1370	T234
1390	T234
55	T33
96/SC9	T33
1260	T208
1262	T208
951	T68

5904VI/1T € 1.740,00 059041161

Sortido recomendado em combinação com RSC23T - RSC24 - RSC24A - RSC24L7 - RSC24L-CAB - RSC24AXL - RSC24AXLP/7 - RSC24AXXL - RSC28 - C37 - C39 - C39MD - C39SM - C39T - RSC55 - RSC50 2.0 - C59 - C57 - C58BC



# 5904VI/3T

jogo de 144 ferramentas em módulo rígido

## ► Manutenção industrial

Nr. Peças/Descrição

Refa. Nr.	TR
42	T05
42	T06
31	T31
32	T31
55	T31
96NSC9	T31
1260	T167
1260N	T167
1262	T202
1267TX	T205
920ME	T80
920/21	T80
920/22	T80
920/25	T80
920/42	T80
920/55	T80
920A	T80
930	T73
940/1	T73
940/2	T73
951	T68
1150BM	T137
1166BM	T137
1084BM	T137
1048N	T153
1052	T153
1032	T145
1034	T145
1036	T145
1038	T145
1032	T146
1034	T146
1036	T146
1038	T146
1370	T231
1390	T231
1719BMA8/T	T231
1719BMA8/P	T231
1719BMA8/M	T231
1651DGTB	T297
1682	T297
1691BM	T297
1741B	T281
1741RV..K	T281
1741RV..K	T281
1741RV..K	T281
1741RV..K	T281
1741RV..K	T281
1112	T279
1128BM	T279
1726	T279
1728BM	T279
1751N	T279
VP6	VP6



T05 T06 T31



T167 T202 T205



T80 T73 T68



T137 T153 T145 T146



T231 T297 T281



T279 VP6

- 16 chaves mistas, boca-luneta 6÷21 mm
- 5 chaves mistas, boca-luneta 22 - 24 - 27 - 30 - 32 mm
- 5 saca-troços Ø 2 - 3 - 4 - 5 - 6 mm
- 1 punção de bico Ø 4 mm
- 12 chaves de bocas 6x7 - 8x9 - 10x11 - 12x13 - 14x15 - 16x17  
18x19 - 20x22 - 21x23 - 24x26 - 27x29 - 30x32 mm
- 9 chaves macho hexagonal Ø 1,5 - 2 - 2,5 - 3 - 4 - 5 - 6 - 8 - 10 mm
- 9 chaves para parafusos de perfil de fenda ● 3x75 - 3,5x100 - 4x100 - 4x150 - 5,5x100 - 5,5x150 - 6,5x150 - 8x150 - 10x200 mm
- 2 chave para parafusos de perfil de fenda série curta ● 4x30 - 6,5x30 mm
- 6 chaves para parafusos de perfil Phillips® ● PH0x60 - PH0x100 - PH1x80 - PH1x120 - PH2x100 - PH2x150 mm
- 7 chaves para parafusos de perfil Torx® ● T6-T7-T8-T9-T10-T15-T20
- 5 chaves de caixa com ponta hexagonal, quadra de 1/2" ○ 5 - 6 - 8 - 10 - 12 mm
- 1 extensão com quadras macho e fêmea de 1/2" 125 mm
- 1 extensão com quadras macho e fêmea de 1/2" 255 mm
- 1 cardan com quadras macho e fêmea de 1/2"
- 1 cabo T corrediço, quadra de 1/2"
- 1 roquete reversível, quadra de 1/2" Ⓞ
- 19 chaves de caixa sextavadas, quadra de 1/2" ○ 10+24 - 26 - 27 - 30 - 32 mm
- 8 chaves tubulares de bisetavadas 6x7 - 8x9 - 10x11 - 12x13 - 14x15 - 16x17  
18x19 - 20x22 mm
- 1 passadores para chaves tubulares
- 1 passadores para chaves tubulares
- 6 chaves em T com três extremidades macho hexagonal ○ 2,5 - 3 - 4 - 5 - 6 - 8 mm
- 1 alicate de pontas semi-redondas extra-longas = 180 mm
- 1 Alicates de pontas semi-redondas extralongas ● 160 mm
- 1 Alicates de corte diagonal para trabalhos pesados < 160 mm
- 1 alicate de charneira fechada 250 mm
- 1 alicate de pressão 240 mm
- 1 alicates de freios interiores com pontas direitas ○ 180 mm
- 1 alicates de freios interiores com pontas curvas ○ 170 mm
- 1 alicates de freios exteriores com pontas direitas ● 175 mm
- 1 alicates de freios exteriores com pontas curvas ● 175 mm
- 1 alicates de freios interiores com pontas direitas ○ 140 mm
- 1 alicates de freios interiores com pontas curvas ○ 225 mm
- 1 alicates de freios exteriores com pontas direitas ● 140 mm
- 1 alicates de freios exteriores com pontas curvas ● 225 mm
- 1 martelo para mecânico, tipo alemão 400 g
- 1 martelo com batentes plásticos intermutáveis Ø 35 mm
- 1 limas perfis diversos 200 mm
- 1 limas perfis diversos 200 mm
- 1 limas perfis diversos 200 mm
- 1 vernier digital
- 1 régua graduadas flexíveis em aço inoxidável 300 mm
- 1 5 m
- 1 alicate de rebitar 250 mm
- 100 rebites em alumínio 2,9x6 mm
- 100 rebites em alumínio 3,2x8 mm
- 100 rebites em alumínio 3,8x10 mm
- 100 rebites em alumínio 4x12 mm
- 100 rebites em alumínio 4,8x12 mm
- 1 tesoura modelo americano 250 mm
- 1 tesoura de electricista 145 mm
- 1 serrote com folha de serra bi-metálica
- (5) folhas de serra (HSS bi-metálicas) .
- 1 Lata de óleo de pressão 200 cc  
vazio

€

5904VI/3T 2.820,00 059041168

Sortido recomendado em combinação com RSC24 com 8 gavetas - RSC24A com 8 gavetas - RSC24AXL com 8-9 gavetas - RSC24AXLP/7 - RSC24AXXL - RSC28 - C37 com 8 gavetas - C39 com 8 gavetas - C39MD - C39SM - RSC50 2.0 - RSC55 - C59B - C58BC - C57

# 5908VI/2T

jogo de 232 ferramentas

## ► Manutenção industrial

### Nr. Peças/Descrição

### Refa. Nr. TR



T80 T05 T06



T91 T68 T40 T41



T199 T202 T201 T204



T234 T271 T153 T236

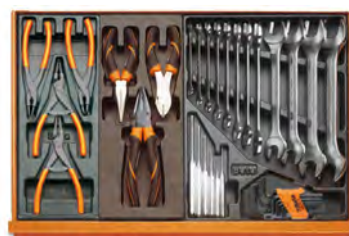

T145 T137 T31



T279 VP5



T273 T270

- 5 chaves de caixa com ponta hexagonal, quadra de 1/2"  $\odot$  5 - 6 - 8 - 10 - 12 mm
- 1 extensão com quadras macho e fêmea de 1/2" 125 mm
- 1 extensão com quadras macho e fêmea de 1/2" 255 mm
- 1 cardan com quadras macho e fêmea de 1/2"
- 1 cabo T correção, quadra de 1/2"
- 1 roquete reversível, quadra de 1/2"  $\otimes$
- 19 chaves de caixa sextavadas, quadra de 1/2"  $\odot$  10÷24 - 26 - 27 - 30 - 32 mm
- 16 chaves mistas, boca-luneta 6÷21 mm
- 5 chaves mistas, boca-luneta 22 - 24 - 27 - 30 - 32 mm
- 13 chaves de caixa sextavadas, quadra de 1/4"  $\odot$  4÷14 mm
- 6 chaves de caixa com ponta sextavadas, quadra de 1/4"  $\odot$  2,5 - 3 - 4 - 5 - 6 - 8 mm
- 1 extensão, quadra 1/4" 50 mm
- 1 extensão, quadra 1/4" 150 mm
- 1 extensão com punho, quadra macho de 1/4"
- 1 cardan com quadras macho e fêmea de 1/4"
- 1 cabo T correção, quadra de 1/4"
- 1 roquete reversível, quadra de 1/4"  $\otimes$
- 6 chaves em T com três extremidades macho hexagonal  $\odot$  2,5 - 3 - 4 - 5 - 6 - 8 mm
- 7 chaves de luneta curvatura profunda 6x7-8x9-10x11-12x13-14x15-16x17-18x19 mm
- 5 chaves de luneta curvatura profunda 20x22 - 21x23 - 24x26 - 25x28 - 27x29 mm
- 7 chaves para parafusos de perfil de fenda  $\bullet$  2,5x50 - 3x75 - 3,5x100 - 4x125 - 5,5x100 - 5,5x150 - 6,5x150 mm
- 6 chaves para parafusos de perfil Phillips®  $\oplus$  PH0x60 - PH0x100 - PH1x80 - PH1x120 - PH2x100 - PH2x150 mm
- 3 chaves para parafusos de perfil de fenda  $\bullet$  8x200 - 10x150 - 10x200 mm
- 2 chave para parafusos de perfil de fenda série curta  $\bullet$  4x30 - 6,5x30 mm
- 2 chaves para parafusos de perfil Phillips®  $\oplus$  PH3x150 - PH4x200 mm
- 2 chaves para parafusos de perfil Phillips® série curta  $\oplus$  PH1x30 - PH2x30 mm
- 2 escopros planos 100 - 200 mm
- 1 martelo para mecânico, tipo alemão 300 g
- 1 martelo com batentes plásticos intermutáveis  $\varnothing$  35 mm
- 1 alicate de rebitar 250 mm
- 100 rebites em alumínio 2,9x6 mm
- 100 rebites em alumínio 3,2x8 mm
- 100 rebites em alumínio 3,8x10 mm
- 100 rebites em alumínio 4x12 mm
- 100 rebites em alumínio 4,8x12 mm
- 1 alicate de chameira fechada 250 mm
- 1 alicate de pressão 240 mm
- 5 jogo de 5 limas meia-murça, com punhos 200 mm
- 1 alicates de freios interiores com pontas direitas  $\odot$  180 mm
- 1 alicates de freios interiores com pontas curvas  $\odot$  170 mm
- 1 alicates de freios exteriores com pontas direitas  $\bullet$  175 mm
- 1 alicates de freios exteriores com pontas curvas  $\bullet$  175 mm
- 1 alicate de pontas semi-redondas extra-longas  $\equiv$  180 mm
- 1 Alicates de pontas semi-redondas extralongas  $\bullet$  160 mm
- 1 Alicates de corte diagonal para trabalhos pesados  $\zeta$  160 mm
- 5 saca-troços  $\varnothing$  2 - 3 - 4 - 5 - 6 mm
- 1 punção de bico  $\varnothing$  4 mm
- 12 chaves de bocas 6x7 - 8x9 - 10x11 - 12x13 - 14x15 - 16x17 - 18x19 - 20x22 - 21x23 - 24x26 - 27x29 - 30x32 mm
- 9 chaves macho hexagonal  $\odot$  1,5 - 2 - 2,5 - 3 - 4 - 5 - 6 - 8 - 10 mm
- 1 tesoura modelo americano 250 mm
- 1 tesoura de electricista 145 mm
- 1 serrote com folha de serra bi-metálica
- 5 folhas de serra (HSS bi-metálicas)
- 1 Lata de óleo de pressão 200 cc
- 1 vazio
- 1 desandador de machos extensível M3÷M12
- 1 desandador de machos extensível M5÷M21
- 1 punho desandador de machos com roquete reversível 2,0÷5,0 mm (M3÷M8)
- 1 punho desandador de machos com roquete reversível 4,6÷8,0 mm (M5÷M12)
- 1 porta - caçonetos 25,4 mm
- 1 porta - caçonetos 38,1 mm
- 1 conta - fios 0,25÷6 W 62÷4x1"
- 26 machos manuais, passo largo M3 - 4 - 5 - 6 - 7 - 8 - 9 - 10 - 12 - 14 - 16 - 18 - 20
- 14 machos manuais, passo fino M6x0,75 - M8x1 - M10x1,25 - M12x1,5 - M14x1,5 - M16x1,5 - M18x1,5
- 7 caçonetos redondos, passo largo M3 - 4 - 5 - 6 - 7 - 8 - 9
- 6 caçonetos redondos, passo largo M10 - 12 - 14 - 16 - 18 - 20
- 2 caçonetos redondos, passo fino M6x0,75 - M8x0,75
- 5 caçonetos redondos, passo fino M10x1,25 - M12x1,5 - M14x1,5 - M16x1,5 - M18x1,5

920ME	T80
920/21	T80
920/22	T80
920/25	T80
920/42	T80
920/55	T80
920A	T80
42	T05
42	T06
900	T91
900ME	T91
900/20	T91
900/21	T91
900BG/30	T91
900/25	T91
900/42	T91
900/55	T91
951	T68
90	T40
90	T41
1260	T199
1262	T202
1260	T201
1260N	T201
1262	T204
1262N	T204
35	T234
1370	T234
1390	T234
1741	T271
1741RV...K	T271
1741RV...K	T271
1741RV...K	T271
1741RV...K	T271
1741RV...K	T271
1048N	T153
1052	T153
1719BMA...S5	T236
1032	T145
1034	T145
1036	T145
1038	T145
1150BM	T137
1166BM	T137
1084BM	T137
31	T31
32	T31
55	T31
96N/SC9	T31
1112	T279
1128BM	T279
1726	T279
1728BM	T279
1751N	T279
VP5	VP5
435/1,5	T273
435/3	T273
436/1	T273
436/2	T273
444/1	T273
444/2	T273
1707	T273
430	T270
433	T270
440	T270
440A	T270
441	T270
441A	T270

€ 3.720,00 059081105

Sortido recomendado em combinação com RSC28 - RSC24/8 - RSC24A/8 - RSC24AXL com 8-9 gavetas - RSC24AXXL - C37/8 - C39/8 - RSC55 - RSC50 2.0 - C59B - C58BC



## 5904VI/2T

jogo de 153 ferramentas em módulo rígido

### ► Manutenção industrial

Nr. Peças/Descrição

- 16 chaves mistas, boca-luneta 6÷21 mm
- 5 chaves mistas, boca-luneta 22 - 24 - 27 - 30 - 32 mm
- 5 saca-troços Ø 2 - 3 - 4 - 5 - 6 mm
- 1 punção de bico Ø 4 mm
- 12 chaves de bocas 6x7 - 8x9 - 10x11 - 12x13 - 14x15 - 16x17  
18x19 - 20x22 - 21x23 - 24x26 - 27x29 - 30x32 mm
- 9 chaves macho hexagonal  $\odot$  1,5 - 2 - 2,5 - 3 - 4 - 5 - 6 - 8 - 10 mm
- 7 chaves de luneta curvatura profunda 6÷29 mm
- 19 chaves de caixa sextavadas, quadra de 1/2"  $\odot$  10÷24 - 26 - 27 - 30 - 32 mm
- 1 extensão com quadras macho e fêmea de 1/2" 125 mm
- 1 extensão com quadras macho e fêmea de 1/2" 255 mm
- 1 cardan com quadras macho e fêmea de 1/2"
- 1 cabo T corrediço, quadra de 1/2"
- 1 roquete reversível, quadra de 1/2"  $\oplus$
- 13 chaves de caixa sextavadas, quadra de 1/4"  $\odot$  4÷14 mm
- 6 chaves de caixa com ponta sextavadas, quadra de 1/4"  $\odot$  2,5÷8 mm
- 1 extensão, quadra 1/4" 50 mm
- 1 extensão, quadra 1/4" 150 mm
- 1 cardan com quadras macho e fêmea de 1/4"
- 1 extensão com punho, quadra macho de 1/4"
- 1 cabo T corrediço, quadra de 1/4"
- 1 roquete reversível, quadra de 1/4"  $\oplus$
- 9 chaves para parafusos de perfil de fenda  $\bullet$  3x75 - 3x100 - 4x100 - 4x150 - 5,5x100 - 5,5x150  
- 6,5x150 - 8x150 - 10x200 mm
- 2 chave para parafusos de perfil de fenda série curta  $\bullet$  4x30 - 6,5x30 mm
- 7 chaves para parafusos de perfil Phillips®  $\oplus$  PH0x60 - PH0x100 - PH1x80 - PH1x120 -  
PH2x100 - PH2x150 - PH3x150 mm
- 2 chaves para parafusos de perfil Phillips® série curta  $\oplus$  PH1x30 - PH2x30 mm
- 1 alicate de charneira fechada 250 mm
- 1 alicate de pressão 240 mm
- 1 Alicates de corte diagonal para trabalhos pesados  $\leq$  160 mm
- 1 Alicates de pontas semirredondas extralongas  $\bullet$  160 mm
- 1 alicate de pontas semi-redondas extra-longas  $\equiv$  180 mm
- 1 alicates de freios interiores com pontas direitas  $\odot$  180 mm
- 1 alicates de freios interiores com pontas curvas  $\odot$  170 mm
- 1 alicates de freios exteriores com pontas direitas  $\bullet$  175 mm
- 1 alicates de freios exteriores com pontas curvas  $\bullet$  175 mm
- 6 chaves em T com três extremidades macho hexagonal  $\odot$  2,5 - 3 - 4 - 5 - 6 - 8 mm
- 5 limas perfis diversos 200 mm
- 2 escopros planos 100 - 200 mm
- 1 martelo para mecânico, tipo alemão 300 g
- 1 martelo com batentes plásticos intermutáveis Ø 35 mm
- 1 alicate de rebitar
- 100 rebites em alumínio 2,9x6 mm
- 100 rebites em alumínio 3,2x8 mm
- 100 rebites em alumínio 3,8x10 mm
- 100 rebites em alumínio 4x12 mm
- 100 rebites em alumínio 4,8x12 mm
- 1 fita métrica 5 m
- 1 mini serrote
- 1 10 lâminas divisível de 18 mm para x-acto ref. 1771, 1771BM, 1771HD
- 1 x - acto com lâmina divisível de 18 mm 170 mm

Refa. Nr.	TR
42	T05
42	T06
31	T31
32	T31
55	T31
96NSC9	T31
90	T40
920A	T83
920/21	T83
920/22	T83
920/25	T83
920/42	T83
920/55	T83
900	T91
900ME	T91
900/20	T91
900/21	T91
900/25	T91
900BG/30	T91
900/42	T91
900/55	T91
1260	T167
1260N	T167
1262	T168
1262N	T168
1048N	T153
1052	T153
1084	T138
1166	T138
1150	T138
1032	T145
1034	T145
1036	T145
1038	T145
951	T68
1719BMA8/S5	T236
35	T234
1370	T234
1390	T234
1741	T271
1741RV..K	T271
1741RV..K	T271
1741RV..K	T271
1741RV..K	T271
1741RV..K	T271
1692	T294
1725CR	T294
1771RL	T294
1771	T294



T05 T06 T31



T40 T83 T91



T167 T168



T153 T138 T145 T68



T236 T234 T271 T294

€

5904VI/2T 2.460,00 059041164

Sortido recomendado em combinação com RSC23T - RSC24 com 7 - 8 gavetas - RSC24A com 7 - 8 gavetas - RSC24AXL - RSC24AXLP/7 - RSC24AXLL - RSC24L/7 - RSC24L-CAB - RSC28 - C37 com 7 - 8 gavetas - C39 com 7 - 8 gavetas - C39MD - C39SM - C59 - C57 - C58BC - RSC55 - RSC50 2.0



## 5910VI/3

Sortido de 297 ferramentas

### ► Manutenção industrial



Nr. Peças/Descrição	Refa. Nr.
6 Ø 2 - 3 - 4 - 5 - 6 - 8 mm	31/B6N
1 punção de bico Ø 4 mm	32
2 escopros planos 125 - 250 mm	35
1 buril, nervurado 200 mm	37
30 chaves mistas, boca-luneta 6-7-8-9-10-11-12-13-14-15-16-17-18-19-20-21-22-23-24-25-26-27-28-29-30-32-35-36-38-41 mm	42
14 chaves de bocas 6x7 - 8x9 - 10x11 - 12x13 - 14x15 - 16x17 - 18x19 - 20x22 - 21x23 - 24x26 - 25x28 - 27x29 - 30x32 - 36x41 mm	55
13 chaves de luneta curvatura profunda 6x7+30x32 mm	90
14 chaves macho hexagonal Ø 1,5 - 2 - 2,5 - 3 - 4 - 5 - 6 - 8 - 10 - 12 - 13 - 14 - 17 - 19 mm	96N
1 Chave ajustável 250 mm	111E
1 chave para tubos, serviço pesado 300 mm	362
25 broca cilíndrica, série curta 1+13x0,5 mm	412/SP25
37 jogo de machos e caçonetos HSS, rosca métrica	447/C37
1 Chaves dinamométricas ZERO-RESET Ⓞ 1/2", 40+200 Nm	666/20
1 extensão articulada com punho em T, quadra de 1/2"	920/40
4 chaves de caixa com ponta hexagonal, quadra de 1/2" Ⓞ 10-12-14-17 mm	920ME
25 jogo com 20 chaves de caixa e 5 acessórios	920A/C20X
17 jogo com 12 chaves de caixa e 5 acessórios 3/4"	928A/C12
12 chaves cachimbo 6 faces 8 - 10 - 11 - 13 - 14 - 17 - 19 - 22 - 24 - 27 - 30 - 32 mm	932
14 chaves em T com três extremidades macho hexagonal 2+14 mm	951/S14
5 chaves macho hexagonal com cardan e cabo em T Ⓞ 3 - 4 - 5 - 6 - 8 mm	953
3 alicates de freios interiores com pontas direitas Ⓞ 180 - 225 - 300 mm	1032
3 alicates de freios interiores com pontas curvas Ⓞ 170 - 210 - 290 mm	1034
3 alicates de freios exteriores com pontas direitas ● 140x1,3 - 175 - 225 mm	1036
3 alicates de freios exteriores com pontas curvas ● 135x1,3 - 175 - 220 mm	1038
2 alicate de charmeira fechada 250 - 300 mm	1048N
1 alicate de pressão, regulação dupla, maxilas longas	1051
1 alicates de corte diagonal para serviços pesados, punhos em bi-matéria, acabamento industrial ⚡ 160 mm	1084GBM
1 alicate de corte frontal, articulado, serviço pesado, grande esforço ⚡ 180 mm	1092V
1 tesoura modelo americano 300 mm	1112
1 tesoura modelo americano com lâminas direitas e estreitas 250 mm	1114
1 tesoura de electricista 147 mm	1128BMX
1 alicate combinado para trabalhos pesados, punhos bi-material, acabamento industrial = 180 mm	1150GBM
1 alicate de pontas semi-redondas com estrias, extra-longas, punhos bi-material, acabamento industrial ● 160 mm	1166GBM
1 alicates de pontas curvas extra longas, punhos em bi-matéria, acabamento industrial ● 160 mm	1168GBM
9 chaves para parafusos de perfil de fenda ● 2,5x50 - 3x75 - 3,5x100 - 4x125 - 5,5x125 - 6,5x150 - 8x200 - 10x200 - 12x250 mm	1260
2 chave para parafusos de perfil de fenda série curta ● 4x30 - 6,5x30 mm	1260N
5 chaves para parafusos de perfil Phillips® ⚡ PH0x100 - PH1x120 - PH2x150 - PH3x150 - PH4x200 mm	1262
2 chaves para parafusos de perfil Phillips® série curta ⚡ PH1x30 - PH2x30 mm	1262N
7 chaves para parafusos de perfil Torx® Ⓞ T6 - T8 - T10 - T15 - T20 - T25 - T30	1267TX
2 martelo para mecânico, tipo alemão 300 - 600 g	1370
2 martelo com batentes plásticos intermutáveis Ø 35 - 60 mm	1390
5 extractores cónicos de parafusos M3+M18	1430/S5
1 extractor universal de duas pernas 23+70 mm	1500N/1
1 extractor universal de duas pernas 23+100 mm	1500N/2
1 paquímetro	1650
1 régua graduada semi-rígida 300 mm	1683
1 riscador, extremidades em carboneto de tungsténio	1688A
1 fita métrica 5 m	1692
1 apalpa - folgas	1708/13
1 pesca-peças magnético 1,8 kg	1712E/2
5 limas perfis diversos 200 mm	1719BMA8/S5
1 serrote com folha de serra bi-metálica	1726BM
1 alicate de rebitar	1741
1 Lata de óleo de pressão 200 cc	1751N

€

5910VI/3 7.750,00 059101044

Sortido recomendado para usar com o item C30M



T05 T06 T31



T40 T41 T80



T167 T168 +96N



T279  
T137 T145 T234 T236



► **Manutenção industrial**

Nr. Peças/Descrição

- 16 chaves mistas, boca-luneta 6÷21 mm
- 5 chaves mistas, boca-luneta 22 - 24 - 27 - 30 - 32 mm
- 5 saca-troços Ø 2 - 3 - 4 - 5 - 6 mm
- 1 punção de bico Ø 4 mm
- 13 chaves de bocas 6x7 - 8x9 - 10x11 - 12x13 - 14x15 - 16x17  
18x19 - 20x22 - 21x23 - 24x26 - 27x29 - 30x32 mm
- 9 chaves macho hexagonal Ø 1,5 - 2 - 2,5 - 3 - 4 - 5 - 6 - 8 - 10 mm
- 5 chaves de luneta curvatura profunda 20x22 - 21x23 - 24x26 - 25x28 - 27x29 mm
- 7 chaves de luneta curvatura profunda 6x7 - 8x9 - 10x11 - 12x13 - 14x15 - 16x17  
18x19 mm
- 5 chaves de caixa com ponta hexagonal, quadra de 1/2" Ø 5 - 6 - 8 - 10 - 12 mm
- 1 extensão com quadras macho e fêmea de 1/2" 125 mm
- 1 extensão com quadras macho e fêmea de 1/2" 255 mm
- 1 cardan com quadras macho e fêmea de 1/2"
- 1 cabo T corredeira, quadra de 1/2"
- 1 roquete reversível, quadra de 1/2" Ⓞ
- 19 chaves de caixa sextavadas, quadra de 1/2" Ø 10÷24 - 26 - 27 - 30 - 32 mm
- 9 chaves para parafusos de perfil de fenda Ⓞ 3x75 - 3x100 - 4x100 - 4x150 - 5,5x100 - 5,5x150  
- 6,5x150 - 8x150 - 10x200 mm
- 2 chave para parafusos de perfil de fenda série curta Ⓞ 4x30 - 6,5x30 mm
- 7 chaves para parafusos de perfil Phillips® Ⓞ PH0x60 - PH0x100 - PH1x80 - PH1x120 -  
PH2x100 - PH2x150 - PH3x150 mm
- 2 chaves para parafusos de perfil Phillips® série curta Ⓞ PH1x30 - PH2x30 mm
- 4 chaves macho hexagonal Ø 13-14-17-19 mm
- 1 tesoura modelo americano 250 mm
- 1 tesoura de electricista 145 mm
- 1 serrote com folha de serra bi-metálica
- (5) folhas de serra (HSS bi-metálicas)
- 1 Lata de óleo de pressão 200 cc
- 1 alicate de pontas semi-redondas extra-longas ≡ 180 mm
- 1 Alicates de pontas semi-redondas extralongas Ⓞ 160 mm
- 1 Alicates de corte diagonal para trabalhos pesados ≡ 160 mm
- 1 alicates de freios interiores com pontas direitas Ø 180 mm
- 1 alicates de freios interiores com pontas curvas Ø 170 mm
- 1 alicates de freios exteriores com pontas direitas Ⓞ 175mm
- 1 alicates de freios exteriores com pontas curvas Ⓞ 175mm
- 2 escopros planos 100 - 200 mm
- 1 martelo para mecânico, tipo alemão 300 g
- 1 martelo com batentes plásticos intermutáveis Ø 35 mm
- 1 limas perfis diversos 200 mm
- 4 chaves mistas, boca-luneta 35-36-38-41 mm
- 1 chaves de bocas 36x41 mm
- 1 Chave ajustável 250 mm
- 1 chave para tubos, serviço pesado 300 mm
- 25 broca cilíndrica, série curta
- 37 jogo de machos e caçonetos HSS, rosca métrica
- 1 Chaves dinamométricas ZERO-RESET Ⓞ 40÷200 Nm
- 17 jogo com 12 chaves de caixa e 5 acessórios 3/4"
- 14 chaves em T com três extremidades macho hexagonal
- 5 chaves macho hexagonal com cardan e cabo em T Ø 3-4-5-6-8 mm
- 1 alicates de freios interiores com pontas direitas Ø 300 mm
- 1 alicates de freios interiores com pontas curvas Ø 290 mm
- 1 alicates de freios exteriores com pontas direitas Ⓞ 225 mm
- 1 alicates de freios exteriores com pontas curvas Ⓞ 220 mm
- 1 alicate de charneira fechada 300 mm
- 1 alicate de pressão, regulação dupla, maxilas longas
- 1 alicate de corte frontal, articulado, serviço pesado, grande esforço ≡ 180 mm
- 1 martelo para mecânico, tipo alemão 600 g
- 1 martelo com batentes plásticos intermutáveis Ø 60 mm
- 5 extractores cónicos de parafusos M3-M18
- 1 extractor universal de duas pernas
- 1 paquímetro
- 1 régua graduada semi-rígida
- 1 riscador, extremidades em carboneto de tungsténio
- 1 fita métrica 5 m
- 1 apalpa - folgas
- 1 pesca-peças magnético

Refa. Nr.	TR
42	T05
42	T06
31	T31
32	T31
55	T31
96NSC9	T31
90	T41
90	T40
920ME	T80
920/21	T80
920/22	T80
920/25	T80
920/42	T80
920/55	T80
920A	T80
1260	T167
1260N	T167
1262	T168
1262N	T168
96N	T168
1112	T279
1128BM	T279
1726	T279
1728BM	T279
1751N	T279
1150BM	T137
1166BM	T137
1084BM	T137
1032	T145
1034	T145
1036	T145
1038	T145
35	T234
1370	T234
1390	T234
1719BMA8/S5	T236
42	
55	
111E	
362	
412/SP25	
447/C37	
666/20	
928A/C12	
951/S14	
953	
1032	
1034	
1036	
1038	
1048N	
1051	
1092V	
1370	
1390	
1430/S5	
1500/3	
1650	
1683	
1688	
1692	
1708/13	
1712E/2	



## 5935VI/2MB

jogo de 133 ferramentas para caixa de ferramentas C35, em tabuleiros maleáveis

### ► Manutenção industrial

#### Nr. Peças/Descrição

- 21 chaves mistas, boca-luneta 6-7-8-9-10-11-12-13-14-15-16-17-18-19-20-21-22-24-27-30-32 mm
- 8 chaves de bocas 6x7-8x9-10x11-12x13-14x15  
16x17-18x19-20x22 mm
- 1 alicate de charneira fechada 250 mm
- 19 chaves de caixa sextavadas, quadra de 1/2" ○ 10-11-12-13-14-15-16-17-18-19-20-21-22-23-24-26-27-30-32 mm
- 1 extensões com quadras macho e fêmea - 1/2" 125 mm
- 1 extensões com quadras macho e fêmea - 1/2" 150 mm
- 1 cardan com quadras macho e fêmea de 1/2"
- 1 cabo T correção, quadra de 1/2"
- 1 roquete reversível, quadra de 1/2" ⊕
- 1 Chave ajustável 250 mm
- 1 alicate de pressão 240 mm
- 1 Alicates de corte diagonal para trabalhos pesados ✂ 160 mm
- 1 alicate de pontas semi-redondas extra-longas ≡ 180 mm
- 1 Alicates de pontas semi-redondas extralongas ● 160 mm
- 1 alicates de freios interiores com pontas direitas ○ 180 mm
- 1 alicates de freios interiores com pontas curvas ○ 170 mm
- 1 alicates de freios exteriores com pontas direitas ● 175 mm
- 1 alicates de freios exteriores com pontas curvas ● 175 mm
- 13 chaves de caixa sextavadas, quadra de 1/4" ○ 4-4,5-5-5,5-6-7-8-9-10-11-12-13-14 mm
- 1 extensão, quadra 1/4" 50 mm
- 1 extensão, quadra 1/4" 150 mm
- 1 cardan com quadras macho e fêmea de 1/4"
- 1 extensão com punho, quadra macho de 1/4"
- 1 roquete reversível, quadra de 1/4" ⊕
- 1 cabo T correção, quadra de 1/4"
- 7 chaves para parafusos de perfil de fenda ● 2,5x50-3x75-3,5x100-4x100-5,5x125-6,5x150-8x200 mm
- 2 chave para parafusos de perfil de fenda série curta ● 4x30-6,5x30 mm
- 7 chaves para parafusos de perfil Phillips® ⊕ PH0x60-PH0x100-PH1x80-PH1x120-PH2x100-PH2x150-PH3x150 mm
- 2 chaves para parafusos de perfil Phillips® série curta ⊕ PH1x30-PH2x30 mm
- 1 busca - pólos ● 4x30-6,5x30 mm
- 9 chaves macho sextavadas com uma extremidade esférica cromadas ○
- 6 chaves em T com três extremidades macho hexagonal ○ 2,5-3-4-5-6-8 mm
- 5 saca-troços Ø 2-3-4-5-6 mm
- 1 punção de bico Ø 4 mm
- 1 escopros planos 200 mm
- 1 tesoura modelo americano 250 mm
- 1 tesoura de electricista 147 mm
- 1 martelo para mecânico, tipo alemão 500 g
- 1 martelo com batentes plásticos intermutáveis Ø 45 mm
- 1 limas quadradas meia-murças, com punho 200 mm
- 1 limas triangulares meia-murças, com punho 200 mm
- 1 limas chatas meia-murças, com punho 200 mm
- 1 limas meia-cana meia-murças, com punho 200 mm
- 1 limas redondas meia-murças, com punho 200 mm
- 1 serrote com folha de serra bi-metálica 440 mm

Refa. Nr.	TR
42	MB12
55	MB12
1048N	MB12
920A	MB37
920AN/125	MB37
920AN/250	MB37
920/25	MB37
920/42	MB37
920/55	MB37
111E	MB37
1052	MB37
1084BM	MB37
1150BM	MB37
1166BM	MB37
1032	MB37
1034	MB37
1036	MB37
1038	MB37
900	MB37
900/20	MB37
900/21	MB37
900/25	MB37
900BG/30	MB37
900/55	MB37
900/42	MB37
1260	MB44
1260N	MB44
1262	MB44
1262N	MB44
1253	MB44
96BPC/SC9	MB44
951	MB44
31	MB55
32	MB55
35	MB55
1112	MB55
1128BMX	MB55
1370	MB55
1390	MB55
1719BMA...Q	MB55
1719BMA...T	MB55
1719BMA...P	MB55
1719BMA...M	MB55
1719BMA...R	MB55
1726	MB55



MB12



MB37



MB44



MB55

€

5935VI/2MB

2.560,00 059351316

Sortido recomendado em combinação com C35





## ► Manutenção industrial

Nr. Peças/Descrição	Refa. Nr.
6 saca-troços Ø 2 - 3 - 4 - 5 - 6 - 8 mm	31/SP6
6 2 punções, 1 punção de bico e 3 escopros	38/SP6
18 chaves mistas, boca-luneta 6-7-8-10-11-12-13-14-15-16-17-19-21-22-24-27-30-32 mm	42
12 chaves de bocas 6x7 ÷ 30x32 mm	55/S12X
8 chaves macho hexagonal 2 - 2,5 - 3 - 4 - 5 - 6 - 8 - 10 mm	96T/S8
8 T9 - T10 - T15 - T20 - T25 - T27 - T30 - T40	97TX/SC8
1 Chave ajustável 250 mm	111E
13 chaves de caixa 12 faces, quadra de 1/2" em suporte metálico ○ 10+22 mm	920B/SB13
8 chaves de caixa 12 faces, quadra de 1/2" em suporte metálico ○ 23+32 mm	920B/SB8
4 chaves de caixa com ponta de fenda ● 1,2x6,5 - 1,2x8 - 1,6x9 - 2x12 mm	920LP
3 chaves de caixa com ponta de perfil Phillips® ⊕ PH2 - 3 - 4	920PH
1 extensão com quadras macho e fêmea de 1/2" 125 mm	920/21
1 extensão com quadras macho e fêmea de 1/2" 255 mm	920/22
1 cardan com quadras macho e fêmea de 1/2"	920/25
1 cabo T corrediço, quadra de 1/2"	920/42
1 roquete reversível, quadra de 1/2" ⊕	920/55
1 alavanca com extremidades chata e pontiaguda	963
2 alicates de freios interiores com pontas direitas ○ 140 - 180 mm	1032
2 alicates de freios interiores com pontas curvas ○ 130 - 170 mm	1034
2 alicates de freios exteriores com pontas direitas ● 140 - 175 mm	1036
2 alicates de freios exteriores com pontas curvas ● 135 - 175 mm	1038
1 alicate de charneira fechada 250 mm	1048N
1 alicate de pressão, regulação dupla, maxilas longas	1051
1 Alicates de corte diagonal para trabalhos pesados ⚡ 160 mm	1084BM
1 alicate de corte frontal, articulado, serviço pesado, grande esforço ⚡ 180 mm	1092V
1 tesoura modelo americano 250 mm	1112
1 tesoura modelo americano com lâminas direitas e estreitas 250 mm	1114
1 tesoura de electricista 147 mm	1128BMX
1 alicate de pontas semi-redondas extra-longas = 180 mm	1150BM
1 Alicates de pontas curvas semirredondas extralongas ● 160 mm	1166BM
1 Alicates de pontas curvas semirredondas extralongas ● 160 mm	1168BM
7 chaves para parafusos de perfil de fenda ● 2,5x50 - 3x75 - 4x100 - 5,5x125 - 6,5x150 - 8x200 - 10x200 mm	1260
4 chaves para parafusos de perfil Phillips® ⊕ PH0x60 - PH1x80 - PH2x100 - PH3x150 mm	1262
3 martelo para mecânico, tipo alemão 300 - 600 - 1000 g	1370
1 martelo com batentes plásticos intermutáveis Ø 35 mm	1390
1 fita métrica 5 m	1692
1 pesca-peças magnético 1,8 kg	1712E/2
1 rascador curvo 150 mm	1717A
1 rascador triangular 200 mm	1717B
5 limas perfis diversos 200 mm	1719BMA8/S5
1 serrote com folha de serra bi-metálica	1725
1 almotolia metálica 200 cc	1751
1 escopros planos 200 mm	35
1 buril, nervurado 200 mm	37
11 chaves cachimbo 6 faces 8 - 10 - 11 - 12 - 13 - 14 - 16 - 17 - 19 - 22 - 24 mm	932
1 alicate de pressão 240 mm	1052
1 alicate de pressão 280 mm	1060
1 alicate de pressão 290 mm	1062
1 martelo anti - recuo com batentes plásticos intermutáveis Ø 50 mm	1392
1 extractor universal de duas pernas 25+130 mm	1500N/2
1 paquímetro	1650
1 régua graduada semi-rígida 300 mm	1683
1 rascador, extremidades em carboneto de tungsténio	1688A
1 apalpa - folgas	1708/13
1 navalha com entalhe para descarnar	1777BM
1 x - acto com lâmina divisível de 18 mm 170 mm	1771BM
1 Alicates de corte diagonal ⚡ 160 mm	1082BM



5957VI

3.940,00 059571005

Sortido recomendado em combinação com C57SA - C57SB - C57SP - C58BC

**5954VI**

jogo de 133 ferramentas

► **Manutenção industrial**

Nr. Peças/Descrição	Refa. Nr.
5 saca-troços Ø 2-3-4-5-6 mm	31
1 punção de bico Ø 4 mm	32
2 escopros planos 200-250 mm	35
18 chaves mistas, boca-luneta	42
6÷14 - 16 - 17 - 18 - 19 - 21 - 22 - 24 - 27 - 30 mm	
12 chaves de bocas 6x7 - 8x9 - 10x11 - 12x13 - 14x15 - 16x17	55
12 chaves macho hexagonal Ø 2÷10 mm	96/SC-12
1 Chave ajustável 250 mm	111E
1 chaves para tubos modelo Sueco mordentes a 45° 320 mm	374
20 chaves de caixa sextavadas, quadra de 1/2"	920A
○ 10÷24 - 26 - 27 - 28 - 30 - 32 mm	
6 chaves de caixa com ponta hexagonal, quadra de 1/2"	920ME
○ 5 - 6 - 8 - 10 - 12 - 14 mm	
1 extensão com quadras macho e fêmea de 1/2" 125 mm	920/21
1 extensão com quadras macho e fêmea de 1/2" 255 mm	920/22
1 cardan com quadras macho e fêmea de 1/2"	920/25
1 extensão articulada com punho em T, quadra de 1/2"	920/40
1 cabo T corrediço, quadra de 1/2"	920/42
1 roquete reversível, quadra de 1/2" Ⓢ	920/55
6 chaves em T com três extremidades macho hexagonal	951
○ 2,5 - 3 - 4 - 5 - 6 - 8 mm	
2 alicates de freios interiores com pontas direitas ○ 140 - 180 mm	1032
1 alicates de freios interiores com pontas curvas ○ 170 mm	1034
2 alicates de freios exteriores com pontas direitas ● 140x1,3 - 175 mm	1036
1 alicates de freios exteriores com pontas curvas ● 175 mm	1038
1 alicate de charneira fechada 250 mm	1048N
1 alicate de pressão 240 mm	1052
1 Alicates de corte diagonal para trabalhos pesados † 160 mm	1084BM
1 alicate de corte frontal, articulado, serviço pesado, grande esforço ‡ 180 mm	1092V
1 tesoura modelo americano 250 mm	1112
1 tesoura de electricista 147 mm	1128BMX
1 alicate de pontas semi-redondas extra-longas ≡ 180 mm	1150BM
1 Alicates de pontas semi-redondas extralongas ● 160 mm	1166BM
1 busca - pólos ●	1253
2 chaves para parafusos de perfil de fenda ● 8x150 - 10x200 mm	1260
2 chave para parafusos de perfil de fenda série curta ● 4x30 - 6,5x30 mm	1260N
2 chaves para parafusos de perfil Phillips® Ⓢ PH3x150 - PH4x200 mm	1262
2 chaves para parafusos de perfil Phillips® série curta Ⓢ PH1x30 - PH2x30 mm	1262N
8 jogo de chaves de parafusos	1263/D8
2 martelo para mecânico, tipo alemão 300 - 500 g	1370
1 martelo com batentes plásticos intermutáveis Ø 45 mm	1390
1 fita métrica 5 m	1692
1 pesca-peças magnético 0,5 kg	1712E/1
5 limas perfis diversos 200 mm	1719BMA8/S5
1 serrote com folha de serra bi-metálica	1726BM
1 almotolia plástica 250 cc	1754



€

5954VI 2.690,00 059541053

Sortido recomendado em combinação com C54S-C55C





M05 M33 M204 M201



M50 M83



M137 M153 M234 M145

## 5904VU/1M

sortido de 90 ferramentas

### ► Utilização universal

#### Nr. Peças/Descrição

- 16 chaves mistas, boca-luneta 6÷21 mm
- 8 chaves de bocas  
6x7 - 8x9 - 10x11 - 12x13 - 14x15 - 16x17 - 18x19 - 20x22 mm
- 9 chaves macho hexagonal  $\odot$  1,5 - 2 - 2,5 - 3 - 4 - 5 - 6 - 8 - 10 mm
- 6 chaves para parafusos de perfil Torx®  $\odot$  T8-T10-T15-T20-T25-T30
- 3 chaves para parafusos de perfil de fenda  $\bullet$  3x75-4x100-6,5x150 mm
- 3 chaves para parafusos de perfil Phillips®  $\oplus$  PH0x60-PH1x80-PH2x100 mm
- 8 chaves macho sextavadas  $\odot$  2-2,5-3-4-5-6-7-8 mm
- 1 extensões com quadras macho e fêmea - 1/2" 125 mm
- 1 extensões com quadras macho e fêmea - 1/2" 250 mm
- 1 cardan com quadras macho e fêmea de 1/2"
- 1 cabo T correção, quadra de 1/2"
- 1 roquete reversível, quadra de 1/2"  $\oplus$
- 19 chaves de caixa sextavadas, quadra de 1/2"  $\odot$  10÷24 - 26 - 27 - 30 - 32 mm
- 1 Alicates de corte diagonal para trabalhos pesados  $\nabla$  160 mm
- 1 alicate de pontas semi-redondas extra-longas  $\equiv$  180 mm
- 1 Alicates de pontas semirredondas extralongas  $\bullet$  160 mm
- 1 alicate de charneira fechada 250 mm
- 1 alicate de pressão 240 mm
- 2 escopros planos 100 - 200 mm
- 1 martelo para mecânico, tipo alemão 300 g
- 1 martelo com batentes plásticos intermutáveis  $\varnothing$  35 mm
- 1 alicates de freios interiores com pontas direitas  $\odot$  180 mm
- 1 alicates de freios interiores com pontas curvas  $\odot$  170 mm
- 1 alicates de freios exteriores com pontas direitas  $\bullet$  175 mm
- 1 alicates de freios exteriores com pontas curvas  $\bullet$  175 mm

Refa. Nr.	TR
42	M05
55	M33
96/SC9	M33
1267TX	M204
1260	M201
1262	M201
96T	M50
920AN/125	M83
920AN/250	M83
920/25	M83
920/42	M83
920/55	M83
920A	M83
1084	M137
1150	M137
1166	M137
1048N	M153
1052	M153
35	M234
1370	M234
1390	M234
1032	M145
1034	M145
1036	M145
1038	M145

€

5904VU/1M

1.570,00 059041201

Sortido recomendado em combinação com RRSC23T - RSC24 - RSC24A - RSC24AXL - RSC24AXLP/7 - RSC24AXXL - RSC24L/7 - RSC24L-CAB - RSC28 - C37 - C39 - C39T - C39SM - C39MD - RSC51 - RSC55 - RSC50 2.0 - C59 - C58BC - C57



## 5904VU/2M

sortido de 144 ferramentas

### ► Utilização universal

#### Nr. Peças/Descrição

- 16 chaves mistas, boca-luneta 6÷21 mm
- 8 chaves de bocas 6x7 - 8x9 - 10x11 - 12x13 - 14x15 - 16x17 - 18x19 - 20x22 mm
- 9 chaves macho hexagonal  $\odot$  1,5 - 2 - 2,5 - 3 - 4 - 5 - 6 - 8 - 10 mm
- 3 chaves para parafusos de perfil de fenda  $\bullet$  3x75-4x100-6,5x150 mm
- 3 chaves para parafusos de perfil Phillips®  $\oplus$  PH0x60-PH1x80-PH2x100 mm
- 6 chaves para parafusos de perfil Torx®  $\otimes$  T8-T10-T15-T20-T25-T30
- 8 chaves macho sextavadas  $\odot$  2-2,5-3-4-5-6-7-8 mm
- 1 extensões com quadras macho e fêmea - 1/2" 125 mm
- 1 extensões com quadras macho e fêmea - 1/2" 250 mm
- 1 cardan com quadras macho e fêmea de 1/2"
- 1 cabo T corrediço, quadra de 1/2"
- 1 roquete reversível, quadra de 1/2"  $\oplus$
- 19 chaves de caixa sextavadas, quadra de 1/2"  $\odot$  10÷24 - 26 - 27 - 30 - 32 mm
- 1 Alicates de corte diagonal para trabalhos pesados  $\text{L}$  160 mm
- 1 alicate de pontas semi-redondas extra-longas  $\text{=}$  180 mm
- 1 Alicates de pontas semirredondas extralongas  $\bullet$  160 mm
- 1 alicate de charneira fechada 250 mm
- 1 alicate de pressão 240 mm
- 2 escopros planos 100 - 200 mm
- 1 martelos para mecânico 300 g
- 1 Martelo com batentes em plástico  $\varnothing$  35 mm
- 1 alicates de freios interiores com pontas direitas  $\odot$  180 mm
- 1 alicates de freios interiores com pontas curvas  $\odot$  170 mm
- 1 alicates de freios exteriores com pontas direitas  $\bullet$  175 mm
- 1 alicates de freios exteriores com pontas curvas  $\bullet$  175 mm
- 1 vazio
- 1 fita métrica 5 m
- 1 mini serrote
- 1 10 lâminas divisível de 18 mm para x-acto ref<sup>a</sup>. 1771, 1771BM, 1771HD
- 1 x - acto com lâmina divisível de 18 mm 170 mm
- 5 bits para parafusos ranhurados, coloridos  $\bullet$  0,5x3 - 0,6x4,5 - 0,8x5,5 - 1x5,5 - 1,2x6,5 mm
- 8 bits sextavados para aparafusadoras eléctricas, coloridos  $\odot$  2 - 2,5 - 3 - 4 - 5 - 6 - 8 - 10 mm
- 5 bits para parafusos Phillips®, coloridos  $\oplus$  PH0 - PH1 - PH2 - PH3 - PH4
- 4 bits para parafusos Phillips®, coloridos  $\oplus$  PZ1 - PZ2 - PZ3 - PZ4
- 11 bits para parafusos Torx®, coloridos  $\otimes$  T6-T7-T8-T9-T10-T15-T20-T25-T27-T30-T40
- 8 bits para parafusos invioláveis Torx®, coloridos  $\oplus$  T9-T10-T15-T20-T25-T27-T30-T40
- 1 porta-pontas magnético com punho 230 mm
- 1 chave de bits reversível  $\oplus$  100 mm
- 5 limas perfis diversos 200 mm
- 1 adaptadores para aparafusadoras
- 1 extensão para porta-bits magnético

Refa. Nr.	TR
42	M05
55	M33
96/SC9	M33
1260	M201
1262	M201
1267TX	M204
96T	M50
920AN/125	M83
920AN/250	M83
920/25	M83
920/42	M83
920/55	M83
920A	M83
1084	M137
1150	M137
1166	M137
1048N	M153
1052	M153
35	M237
1370T	M237
1390N	M237
1032	M145
1034	M145
1036	M145
1038	M145
VPM3	VPM3
1692	M294
1725CR	M294
1771RL	M294
1771	M294
860LP	M85
860PE	M85
860PH	M85
860PZ	M85
860TX	M85
860RTX	M85
851SR	M85
860/55	M85
1719BMA8/S5	M236
892/0	M85
882P	M85



M05 M33 M204 M201



M50 M83



M137 M153 M237 M145



VPM3 M294 M85 M236

€

5904VU/2M 2.040,00 059041212

Sortido recomendado em combinação com RSC23T - RSC24 - RSC24A - RSC24AXL - RSC24AXLP/7 - RSC24AXXL - RSC24L/7 - RSC24L-CAB - RSC28 - C37 - C39 - C39SM - C39MD - C39T - RSC55 - RSC50 2.0 - C59 - C58BC - C57

# 5904VU/2T

sortido de 104 ferramentas

## ► Utilização universal



T199 T202 T83



T145 T153 T138 T234

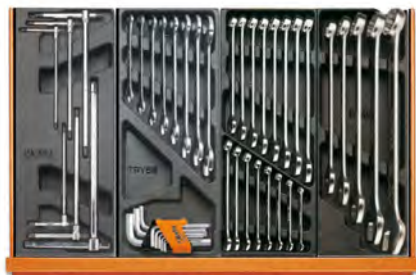

T68 T33 T05 T06



T284

### Nr. Peças/Descrição

- 7 chaves para parafusos de perfil de fenda  
  - 2,5x50 - 3x75 - 3,5x100 - 4x125 - 5,5x100 - 5,5x150 - 6,5x150 mm
- 6 chaves para parafusos de perfil Phillips®  
  - ⊕ PH0x60 - PH0x100 - PH1x80 - PH1x120 - PH2x100 - PH2x150 mm
- 19 chaves de caixa sextavadas, quadra de 1/2"  
  - 10-11-12-13-14-15-16-17-18-19-20-21-22-23-24-26-27-30-32 mm
- 1 extensão com quadras macho e fêmea de 1/2" 125 mm
- 1 extensão com quadras macho e fêmea de 1/2" 255 mm
- 1 cardan com quadras macho e fêmea de 1/2"
- 1 cabo T correção, quadra de 1/2" 305 mm
- 1 roquete reversível, quadra de 1/2" ⊕
- 1 alicates de freios interiores com pontas direitas ○ 180 mm
- 1 alicates de freios interiores com pontas curvas ○ 170 mm
- 1 alicates de freios exteriores com pontas direitas ● 175 mm
- 1 alicates de freios exteriores com pontas curvas ● 175 mm
- 1 alicate de charneira fechada 250 mm
- 1 alicate de pressão 240 mm
- 1 Alicates de corte diagonal para trabalhos pesados < 160 mm
- 1 alicate de pontas semi-redondas extra-longas = 180 mm
- 1 Alicates de pontas semirredondas extralongas ● 160 mm
- 2 escopros planos 100-200 mm
- 1 martelo para mecânico, tipo alemão 300 g
- 1 martelo com batentes plásticos intermutáveis Ø 35 mm
- 6 chaves em T com três extremidades macho hexagonal ○ 2,5-3-4-5-6-8 mm
- 8 chaves de bocas 6x7-8x9-10x11-12x13-14x15  
  - 16x17-18x19-20x22 mm
- 9 chaves macho hexagonal ○ 1,5÷10 mm
- 16 chaves mistas, boca-luneta 6-7-8-9-10-11-12-13-14-15-16-17  
  - 18-19-20-21 mm
- 5 chaves mistas, boca-luneta 22-24-27-30-32 mm
- 1 tesoura de electricista 147 mm
- 1 tesoura multiusos
- 1 limas quadradas meia-murças, com punho 200 mm
- 1 limas chatas meia-murças, com punho 200 mm
- 1 limas triangulares meia-murças, com punho 200 mm
- 1 limas meia-cana meia-murças, com punho 200 mm
- 1 limas redondas meia-murças, com punho 200 mm
- 1 serrote com folha de serra bi-metálica
- 1 folhas de serra (HSS bi-metálias)
- 1 x - acto com lâmina divisível de 18 mm 170 mm
- 1 canivete, 185 mm

Refa. Nr.	TR
1260	T199
1262	T202
920A	T83
920/21	T83
920/22	T83
920/25	T83
920/42	T83
920/55	T83
1032	T145
1034	T145
1036	T145
1038	T145
1048N	T153
1052	T153
1084	T138
1150	T138
1166	T138
35	T234
1370	T234
1390	T234
951	T68
55	T33
96/SC9	T33
42	T05
42	T06
1128BMX	T284
1130BMX	T284
1719BMA...Q	T284
1719BMA...P	T284
1719BMA...T	T284
1719BMA...M	T284
1719BMA...R	T284
1726BM	T284
1728BM	T284
1771BM	T284
1778V18	T284

€

5904VU/2T

1.870,00 059041070

Sortido recomendado em combinação com RSC23T - RSC24 - RSC24A - RSC24AXL - RSC24AXLP/7 - RSC24AXXL - RSC24L/7 - RSC24L-CAB  
 RSC28 - C37 - C39 - C39SM - C39MD - C39T RSC55 - RSC50 2.0 - C59 - C58BC - C57

# 5904VU/3T

sortido de 146 ferramentas

## ► Utilização universal

### Nr. Peças/Descrição

- 16 chaves mistas, boca-luneta 6÷21 mm
- 5 chaves mistas, boca-luneta 22 - 24 - 27 - 30 - 32 mm
- 5 saca-troços Ø 2 - 3 - 4 - 5 - 6 mm
- 1 punção de bico Ø 4 mm
- 12 chaves de bocas 6x7 - 8x9 - 10x11 - 12x13 - 14x15 - 16x17 - 18x19 - 20x22 - 21x23 - 24x26 - 27x29 - 30x32 mm
- 9 chaves macho hexagonal Ø 1,5 - 2 - 2,5 - 3 - 4 - 5 - 6 - 8 - 10 mm
- 6 chaves macho sextavadas Ø 2 - 2,5 - 3 - 4 - 5 - 6 mm
- 6 chaves para parafusos de perfil Torx® T10-T15-T20-T25-T27-T30
- 5 chaves de caixa com ponta hexagonal, quadra de 1/2" Ø 5 - 6 - 8 - 10 - 12 mm
- 1 extensão com quadras macho e fêmea de 1/2" 125 mm
- 1 extensão com quadras macho e fêmea de 1/2" 255 mm
- 1 cardan com quadras macho e fêmea de 1/2"
- 1 cabo T correção, quadra de 1/2"
- 1 roquete reversível, quadra de 1/2" Ⓢ
- 19 chaves de caixa sextavadas, quadra de 1/2" Ø 10÷24 - 26 - 27 - 30 - 32 mm
- 13 chaves de caixa sextavadas, quadra de 1/4" Ø 4-4,5-5-5,5-6-7-8-9-10-11-12-13-14 mm
- 6 chaves de caixa com ponta sextavadas, quadra de 1/4" Ø 2,5-3-4-5-6-8 mm
- 1 extensão, quadra 1/4" 50 mm
- 1 extensão, quadra 1/4" 150 mm
- 1 cardan com quadras macho e fêmea de 1/4"
- 1 extensão com punho, quadra macho de 1/4"
- 1 cabo T correção, quadra de 1/4" 115 mm
- 1 roquete reversível, quadra de 1/4" Ⓢ
- 1 alicates de freios interiores com pontas direitas Ø 180 mm
- 1 alicates de freios interiores com pontas curvas Ø 170 mm
- 1 alicates de freios exteriores com pontas direitas Ø 175 mm
- 1 alicates de freios exteriores com pontas curvas Ø 175 mm
- 1 alicate de pontas semi-redondas extra-longas = 180 mm
- 1 Alicates de pontas semirredondas extralongas Ø 160 mm
- 1 Alicates de corte diagonal para trabalhos pesados 160 mm
- 1 alicate de charneira fechada 250 mm
- 1 alicate de pressão 240 mm
- 4 chaves para parafusos de perfil de fenda 3x75 - 4x100 - 5,5x150 - 6,5x150 mm
- 3 chave para parafusos de perfil Pozidriv®-Supadriv® PZ0 - PZ1 - PZ2
- 7 chaves para parafusos de perfil Torx® T6-T7-T8-T9-T10-T15-T20
- 2 escopros planos 100 - 200 mm
- 1 martelo para mecânico, tipo alemão 300 g
- 1 martelo com batentes plásticos intermutáveis Ø 35 mm
- 5 limas perfis diversos 200 mm

Refa. Nr.	TR
42	T05
42	T06
31	T31
32	T31
55	T31
96NVC9	T31
96T	T52
97TTX	T55
920ME	T80
920/21	T80
920/22	T80
920/25	T80
920/42	T80
920/55	T80
920A	T80
900	T91
900ME	T91
900/20	T91
900/21	T91
900/25	T91
900BG/30	T91
900/42	T91
900/55	T91
1032	T145
1034	T145
1036	T145
1038	T145
1150	T138
1166	T138
1084	T138
1048N	T153
1052	T153
1260	T198
1269PZ	T198
1267TX	T205
35	T234
1370	T234
1390	T234
1719BMA8/S5	T236



T05 T06 T31



T52 T55 T80



T91 T145 T138 T153



T198 T205 T234 T236

€

5904VU/3T 2.270,00 059041203

Sortido recomendado em combinação com RSC23T - RSC24 - RSC24A - RSC24AXL - RSC24AXLP/7 - RSC24AXXL - RSC24L/7 - RSC24L-CAB C37- C39 - C39T - C39SM - C39MD - RSC55 - RSC50 2.0 - C59 - C58BC - C57



## 5904VU/4T

sortido de 197 ferramentas em tabuleiros em plástico ABS

### ► Utilização universal



T01

T83

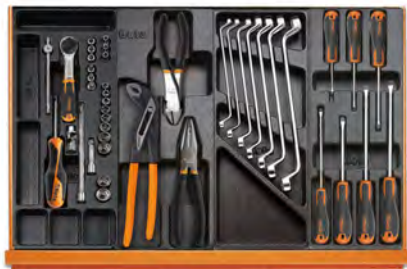

T91

T156

T40

T211

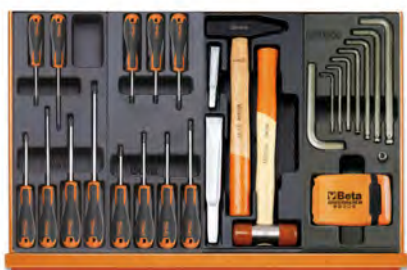

T213

T216

T234

T259

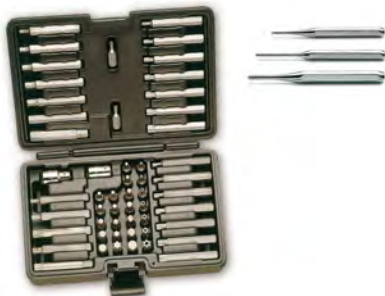

#### Nr. Peças/Descrição

- 1 punções Ø 4 mm
- 1 saca-troços Ø 4 mm
- 1 punção de bico Ø 4 mm
- 54 jogo com 52 pontas hexagonais, 10 mm, e 2 acessórios
- 17 chaves mistas, boca-luneta 6-7-8-10-11-12-13-14-16-17-18-19-21-22-24-27-30 mm
- 7 chaves de luneta curvatura profunda 6x7-8x9-10x11-12x13-14x15-16x17-18x19 mm
- 19 chaves de caixa sextavadas, quadra de 1/2"
  - 10-11-12-13-14-15-16-17-18-19-20-21-22-23-24-26-27-30-32 mm
- 1 extensão com quadras macho e fêmea de 1/2" 125 mm
- 1 extensão com quadras macho e fêmea de 1/2" 250 mm
- 1 cardan com quadras macho e fêmea de 1/2"
- 1 cabo T correção, quadra de 1/2" 305 mm
- 1 roquete reversível, quadra de 1/2"
  - 10-11-12-13-14-15-16-17-18-19-20-21-22-23-24-26-27-30-32 mm
- 13 chaves de caixa sextavadas, quadra de 1/4" ○ 4-4,5-5-5,5-6-7-8-9-10-11-12-13-14 mm
- 6 chaves de caixa com ponta sextavadas, quadra de 1/4" ○ 2,5-3-4-5-6-8 mm
- 1 extensão, quadra 1/4" 50 mm
- 1 extensão, quadra 1/4" 150 mm
- 1 cardan com quadras macho e fêmea de 1/4"
- 1 extensão com punho, quadra macho de 1/4"
- 1 cabo T correção, quadra de 1/4" 115 mm
- 1 roquete reversível, quadra de 1/4"
  - 4-4,5-5-5,5-6-7-8-9-10-11-12-13-14 mm
- 1 Alicates de corte diagonal 160 mm
- 1 alicate de pontas semi-redondas extra-longas = 180 mm
- 1 alicate de charneira fechada 250 mm
- 7 chaves para parafusos de perfil de fenda
  - 2,5x50 - 3x75 - 3,5x100 - 4x125 - 5,5x100 - 5,5x150 - 6,5x150 mm
- 6 chave para parafusos de perfil Phillips®
  - ⊕ PH0x60 - PH1x80 - PH1x120 - PH2x100 - PH2x150 - PH3x150 mm
- 7 chaves para parafusos de perfil Torx®, com punho ○ T6-T7-T8-T9-T10-T15-T20
- 2 escopros planos 100-200 mm
- 1 martelo para mecânico, tipo alemão 300 g
- 1 martelo com batentes plásticos intermutáveis Ø 35 mm
- 7 chaves macho hexagonal com uma extremidade esférica, brunidas ○ 2,5-3-4-5-6-8-10 mm
- 1 chaves macho hexagonal ○ 12 mm
- 31 jogo de 30 pontas com porta pontas magnético de desengate rápido em caixa plástica ● ○ ⊕ ⊕ ⊕ ⊕
- 1 chave de caixa porta-pontas com encaixe quadra fêmea

Refa. Nr.	TR
30	
31	
32	
867/C52	
42	T01
90	T40
920A	T83
920/21	T83
920/22	T83
920/25	T83
920/42	T83
920/55	T83
900	T91
900ME	T91
900/20	T91
900/21	T91
900/25	T91
900BG/30	T91
900/42	T91
900/55	T91
1082	T156
1150	T156
1048N	T156
1201E	T211
1202E	T213
1207E/TX	T216
35	T234
1370	T234
1390	T234
96BP	T259
96N	T259
860MIX/A31	T259
895/1	T259

€

5904VU/4T

1.750,00 059241100

Sortido recomendado para utilização conjunta com referências RSC23T - RSC24 - RSC24A - RSC24AXL - RSC24AXLP/7 - RSC24AXXL - RSC24L/7 - RSC24L-CAB C37 - C39 - C39T - C39SM - C39MD - RSC55 - RSC50 2.0 - C59 - C58BC - C57

# 5908VU/2T

jogo de 161 ferramentas em módulos soft ABS

## ► Utilização universal

Nr. Peças/Descrição



T05 T06 T31



T40 T52 T55 T91



T82 T138 T153



T145 T170 T171 T172



T173 T234 T236 VP4

Nr. Peças/Descrição	Refa. Nr.	TR
16 chaves mistas, boca-luneta 6+21 mm	42	T05
5 chaves mistas, boca-luneta 22 - 24 - 27 - 30 - 32 mm	42	T06
5 saca-troços Ø 2 - 3 - 4 - 5 - 6 mm	31	T31
1 punção de bico Ø 4 mm	32	T31
12 chaves de bocas 6x7 - 8x9 - 10x11 - 12x13 - 14x15 - 16x17 18x19 - 20x22 - 21x23 - 24x26 - 27x29 - 30x32 mm	55	T31
9 chaves macho hexagonal Ø 1,5 - 2 - 2,5 - 3 - 4 - 5 - 6 - 8 - 10 mm	96NSC9	T31
7 chaves de luneta curvatura profunda 6x7-8x9-10x11-12x13-14x15-16x17-18x19 mm	90	T40
6 chaves macho sextavadas Ø 2-2,5-3-4-5-6 mm	96T	T52
6 chaves para parafusos de perfil Torx® Ⓢ T10-T15-T20-T25-T27-T30	97TTX	T55
19 chaves de caixa sextavadas, quadra de 1/2" Ø 10-11-12-13-14-15-16-17-18-19-20-21-22-23-24-26-27-30-32 mm	920A	T82
5 chaves de caixa com ponta hexagonal, quadra de 1/2" Ø 5-6-8-10-12 mm	920ME	T82
1 extensões com quadras macho e fêmea - 1/2" 125 mm	920AN/125	T82
1 extensões com quadras macho e fêmea - 1/2" 250 mm	920AN/250	T82
1 cardan com quadras macho e fêmea de 1/2"	920/25	T82
1 cabo T correção, quadra de 1/2" 305 mm	920/42	T82
1 roquete reversível, quadra de 1/2" Ⓢ	920/55	T82
13 chaves de caixa sextavadas, quadra de 1/4" Ø 4-4,5-5-5,5-6-7-8-9-10-11-12-13-14 mm	900	T91
6 chaves de caixa com ponta sextavadas, quadra de 1/4" Ø 2,5-3-4-5-6-8 mm	900ME	T91
1 extensão, quadra 1/4" 50 mm	900/20	T91
1 extensão, quadra 1/4" 150 mm	900/21	T91
1 cardan com quadras macho e fêmea de 1/4"	900/25	T91
1 extensão com punho, quadra macho de 1/4"	900BG/30	T91
1 cabo T correção, quadra de 1/4" 115 mm	900/42	T91
1 roquete reversível, quadra de 1/4" Ⓢ	900/55	T91
1 Alicates de corte diagonal para trabalhos pesados 160 mm	1084	T138
1 alicate de pontas semi-redondas extra-longas 180 mm	1150	T138
1 Alicates de pontas semirredondas extralongas 160 mm	1166	T138
1 alicates de freios interiores com pontas direitas 180 mm	1032	T145
1 alicates de freios interiores com pontas curvas 170 mm	1034	T145
1 alicates de freios exteriores com pontas direitas 175 mm	1036	T145
1 alicates de freios exteriores com pontas curvas 175 mm	1038	T145
1 alicate de charneira fechada 250 mm	1048N	T153
1 alicate de pressão 240 mm	1052	T153
7 chaves para parafusos de perfil Phillips® ● 2,5x50-3x75-3,5x100-4x125-5,5x100-5,5x150-6,5x150 mm	1290	T171
3 chaves para parafusos de perfil Phillips® ● 8x150-8x200-10x200 mm	1290N	T171
2 chave para parafusos de perfil de fenda série curta ● 4x30-6,5x30 mm	1292	T172
6 chaves para parafusos de perfil Phillips® Ⓢ PH0x60-PH0x100-PH1x80-PH1x120-PH2x100-PH2x150 mm	1292	T173
2 chaves para parafusos de perfil Phillips® Ⓢ PH3x150-PH4x200 mm	1292N	T173
2 chave para parafusos de perfil Phillips® série curt Ⓢ PH1x30-PH2x30 mm	35	T234
2 escopros planos 100-200 mm	1370	T234
1 martelo para mecânico, tipo alemão 300 g	1390	T234
1 martelo com batentes plásticos intermutáveis Ø 35 mm	1719BMA...Q	T236
1 limas quadradas meia-murças, com punho 200 mm	1719BMA...T	T236
1 limas triangulares meia-murças, com punho 200 mm	1719BMA...P	T236
1 limas chatas meia-murças, com punho 200 mm	1719BMA...M	T236
1 limas meia-cana meia-murças, com punho 200 mm	1719BMA...M	T236
1 limas redondas meia-murças, com punho 200 mm	1719BMA...R	T236
1 vazios	VP4	

€

5908VU/2T 2.580,00 059081136

Seleção recomendada em combinação com as referências RSC23T - RSC24 (6-7-8 gavetas) - RSC24A (6-7-8 gavetas) - RSC24AXL - RSC24AXLP/7 - RSC24AXLL - RSC24L/7 - RSC24L-CAB - RSC28 - C37 ( 6-7-8 gavetas) - C39 (6-7-8 gavetas) - C39MD - C39SM - RSC55 - RSC50 2.0 - C59 - C58BC - C57

## 5914VU/M

jogo de 109 ferramentas para trolley C14, em tabuleiros de espuma EVA

### ► Utilização universal

#### Nr. Peças/Descrição

- 31 jogo de 30 bits com porta-bits magnético de desengate rápido
- 1 chave de caixa porta-pontas com encaixe quadra fêmea
- 13 chaves de caixa sextavadas, quadra de 1/4" ○ 4-4,5-5,5-6-7-8-9-10-11-12-13-14 mm
- 1 extensão, quadra 1/4" 150 mm
- 1 cardan com quadras macho e fêmea de 1/4"
- 1 extensão 1/4" com punho, série curta
- 1 cabo T corrediço, quadra de 1/4"
- 1 roquete reversível, quadra de 1/4" ⊕
- 16 chaves de caixa sextavadas, quadra de 1/2" ○ 10-11-12-13-14-15-16-17-18-19-21-22-24-27-30-32 mm
- 1 cardan com quadras macho e fêmea de 1/2"
- 1 extensões com quadras macho e fêmea - 1/2"
- 1 cabo T corrediço, quadra de 1/2"
- 1 roquete reversível, quadra de 1/2" ⊕
- 16 chaves mistas, boca-luneta 6-7-8-9-10-11-12-13-14-15-16-17-18-19-21-22 mm
- 9 chaves macho hexagonal ○ 1,5-2-2,5-3-4-5-6-8-10 mm
- 1 Chave ajustável 250 mm
- 1 tesoura de electricista 147 mm
- 1 fita métrica 5 m
- 1 x - acto com lâmina divisível de 18 mm 170 mm
- 1 alicate de charneira fechada 250 mm
- 1 Alicates de corte diagonal ∟ 160 mm
- 1 alicate de pontas semi-redondas extra-longas = 180 mm
- 1 Alicates de pontas semi-redondas extralongas ● 160 mm
- 3 chaves para parafusos de perfil de fenda ● 3,5x100-5,5x125-6,5x150 mm
- 3 chaves para parafusos de perfil Phillips® ⊕ PH0x60-PH1x80-PH2x100 mm

Refa. Nr.	TR
861MIX/A31	MCT1
895/1	MCT1
900	MCT1
900/...	MCT1
900/25	MCT1
900BG/30C	MCT1
900/42	MCT1
900/55	MCT1
920A	MCT1
920/25	MCT1
920AN/125	MCT1
920/42	MCT1
920/55	MCT1
42	MCT2
96/SC9	MCT2
111E	MCT2
1128BMX	MCT2
1692/5	MCT2
1771	MCT2
1048N	MCT3
1082BM	MCT3
1150BM	MCT3
1166BM	MCT3
1260	MCT3
1262	MCT3



MC T1



MC T2



MC T3

€

5914VU/M

1.260,00 059140112

Jogo recomendado para utilização em combinação com o trolley de ferramentas C14

Nota: para que o módulo superior do trolley feche corretamente, o painel de ferramentas por baixo da tampa deve ser removido.



# 5988U/7M

sortido de 215 ferramentas em módulo soft

## ► Utilização universal



M01



M100

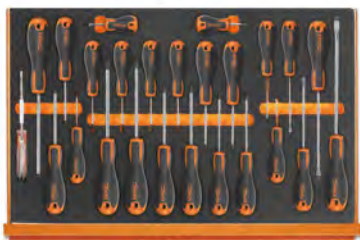

M213



M33 M86 M136 M234

### Nr. Peças/Descrição

- 22 chaves mistas, boca-luneta 6-7-8-9-10-11-12-13-14-15-16-17-18-19-20-21-22-24-27-30-32-36 mm
- 8 chaves de bocas 6x7-8x9-10x11-12x13-14x15-16x17-18x19-20x22 mm
- 9 chaves macho hexagonal  $\odot$  1,5+10 mm
- 7 pontas macho hexagonal  $\odot$  4-5-6-7-8-10-12 mm
- 7 pontas hexagonais  $\odot$  4-5-6-7-8-10-12 mm
- 5 pontas para parafusos de perfil XZN<sup>®</sup>  $\odot$  5-6-8-10-12 mm
- 5 pontas com perfil XZN<sup>®</sup>  $\odot$  5-6-8-10-12 mm
- 7 pontas para parafusos de perfil Torx<sup>®</sup>  $\odot$  T20-T25-T30-T40-T45-T50-T55
- 6 pontas para parafusos de perfil Torx<sup>®</sup>  $\odot$  T25-T30-T40-T45-T50-T55
- 7 pontas para parafusos de perfil Tamper Resistant Torx<sup>®</sup>  $\odot$  T20-T25-T30-T40-T45-T50-T55
- 1 chaves de caixa porta-pontas para artigos 867
- 1 chaves de caixa porta-pontas para artigos 867
- 1 chave de caixa porta-pontas com encaixe quadra fêmea
- 1 chave de caixa porta-pontas com encaixe quadra fêmea
- 1 chave de caixa porta-pontas com encaixe quadra fêmea
- 13 chaves de caixa sextavadas, quadra de 1/4"  $\odot$  4-4,5-5-5,5-6-7-8-9-10-11-12-13-14 mm
- 9 chaves de caixa série longa, boca sextavadas  $\odot$  5-6-7-8-9-10-11-12-13 mm
- 5 chaves de caixa com ponta sextavadas, quadra de 1/4"  $\odot$  3-4-5-6-7 mm
- 4 chaves de caixa com ponta de perfil de fenda  $\bullet$  0,8x4-1x5,5-1,2x6,5-1,2x8 mm
- 4 chaves de caixa com ponta de perfil Phillips<sup>®</sup>  $\oplus$  PH1-PH2-PH3-PH4
- 7 chaves de caixa com ponta macho de perfil Torx<sup>®</sup>  $\odot$  T10-T15-T20-T25-T27-T30-T40
- 1 extensão, quadra 1/4" 50 mm
- 1 extensão, quadra 1/4" 100 mm
- 1 extensão, quadra 1/4" 150 mm
- 1 cardan com quadras macho e fêmea de 1/4"
- 1 extensão com punho, quadra macho de 1/4"
- 1 cabo T corredeira, quadra de 1/4"
- 1 roquete reversível, quadra de 1/4"  $\oplus$
- 21 chaves de caixa sextavadas, quadra de 1/2"  $\odot$  8-10-11-12-13-14-15-16-17-18-19-20-21-22-23-24-26-27-28-30-32 mm
- 1 redução quadra fêmea de 1/2" para quadra macho de 3/8"
- 1 cardan com quadras macho e fêmea de 1/2"
- 1 extensões com quadras macho e fêmea - 1/2" 125 mm
- 1 extensões com quadras macho e fêmea - 1/2" 250 mm
- 1 cabo T corredeira, quadra de 1/2"
- 1 roquete reversível, quadra de 1/2"  $\oplus$
- 8 chaves de caixa com quadra fêmea de 1/2", para parafusos com perfil Torx<sup>®</sup>  $\odot$  10-12-14-16-18-20-22-24 mm
- 11 chaves de caixa série longa, boca hexagonal  $\odot$  10-12-13-14-15-16-17-18-19-21-22 mm
- 1 Alicates de corte diagonal para trabalhos pesados  $\text{Z}$  160 mm
- 1 alicate de pontas semi-redondas extra-longas  $\text{=}$  180 mm
- 1 Alicates de pontas semi-redondas extralongas  $\bullet$  160 mm
- 6 chaves para parafusos de perfil de fenda  $\bullet$  2,5x50-3x75-4x100-5,5x125-6,5x150-8x200 mm
- 1 chave para parafusos de perfil de fenda, série extra curta  $\bullet$  4x30 mm
- 4 chave para parafusos de perfil Phillips<sup>®</sup>  $\oplus$  PH0x60-PH1x80-PH2x100-PH3x150 mm
- 1 chave para parafusos de perfil Phillips<sup>®</sup>, série extra curta  $\oplus$  PH1X30 mm
- 12 chaves para parafusos de perfil Torx<sup>®</sup>, com punho  $\odot$  T6-T7-T8-T9-T10-T15-T20-T25-T27-T30-T40-T45
- 1 busca - pólos  $\bullet$
- 2 escopros planos 100-200 mm
- 1 martelo para mecânico, tipo alemão 300 g
- 1 martelo com batentes plásticos intermutáveis  $\varnothing$  35 mm

Refa. Nr.	TR
42	M01
55	M33
96SC9	M33
867PE	M86
867PE/L	M86
867XZN	M86
867XZN/L	M86
867TX	M86
867TX/L	M86
867RTX	M86
867/1	M86
867/2	M86
895/1	M100
895/3	M100
895/6	M100
900	M100
900L	M100
900ME	M100
900LP	M100
900PH	M100
900TX	M100
900/20	M100
900/20L	M100
900/21	M100
900/25	M100
900BG/30	M100
900/42	M100
900/55	M100
920A	M100
920/15	M100
920/25	M100
920AN/125	M100
920AN/250	M100
920/42	M100
920/55	M100
920FTX	M100
920AL	M100
1084BM	M136
1150BM	M136
1166BM	M136
1201E	M213
1201EN	M213
1202E	M213
1202EN	M213
1207E/TX	M213
1253	M213
35	M234
1370	M234
1390	M234

€

5988U/7M 2.600,00 059881019

Seleção recomendada em combinação com as referências RSC23T - RSC24 - RSC24A - RSC24AXL - RSC24AXLP/7 - RSC24AXXL - RSC24L/7 - RSC24L-CAB RSC28 - C37 - C39 - C39SM - C39MD - RSC55 - RSC50 2.0 - C59 - C58BC - C57

## 5915VU/0

sortido de 35 ferramentas

### ► Universais

#### Nr. Peças/Descrição

- 1 punção de bico 4 mm
- 1 escopros planos 125 mm
- 8 chaves de bocas 6x7-8x9-10x11-12x13-14x15-16x17-18x19-20x22 mm
- 7 Jogo de 7 chaves macho sextavadas  $\varnothing$  1,5-2-2,5-3-4-5-6 mm
- 1 Chave ajustável 150 mm
- 1 alicate de charneira fechada 250 mm
- 1 alicate de corte diagonal, punhos com duplo revestimento PVC, acabamento industrial  $\nabla$  160 mm
- 1 tesoura de electricista 147 mm
- 1 alicate combinado para trabalhos pesados, punhos com duplo revestimento PVC, acabamento industrial  $\equiv$  180 mm
- 1 alicate de ponta semi-redondas com estrias, extra-longas, punhos com duplo revestimento PVC, acabamento industrial  $\bullet$  160 mm
- 4 chaves para parafusos de perfil de fenda  $\bullet$  3x75-4x100-5,5x100-6,5x150 mm
- 3 chave para parafusos de perfil Phillips®  $\bullet$  PH0x60-PH1x80-PH2x100 mm
- 1 martelo para mecânico, tipo alemão 300 g
- 1 fita métrica 3 m
- 1 x - acto com lâmina divisível de 18 mm 170 mm
- 1 navalha manutenção automóvel
- 1 lanterna LED de elevada luminosidade, em alumínio anodizado robusto, até 500 lumens

Refa. Nr.  
32  
35  
55  
96/BGS7  
111E  
1048N  
1082G  
1128BMX  
1150G  
1166G  
1201E  
1202E  
1370  
1692/3  
1771  
1778SOS  
1833S



€

5915VU/0 463,00 059151021

Sortido recomendado em combinação com C5 - C5S - C6T - C9MT

## 5915VU/1

jogo de 45 ferramentas

### ► Universais

#### Nr. Peças/Descrição

- 2 punções  $\varnothing$  2-3 mm
- 1 punção de bico  $\varnothing$  4 mm
- 2 escopros planos 125-150 mm
- 1 buris 150 mm
- 14 chaves mistas, boca-luneta 6+14 - 17 - 19 - 21 - 22 - 24 mm
- 9 chaves macho hexagonal  $\varnothing$  1,5 - 2 - 2,5 - 3 - 4 - 5 - 6 - 8 - 10 mm
- 1 Chave ajustável 250 mm
- 1 alicate de charneira fechada 250 mm
- 1 alicate de corte diagonal, punhos com duplo revestimento PVC, acabamento industrial  $\nabla$  160 mm
- 1 tesoura de electricista 147 mm
- 1 alicate combinado para trabalhos pesados, punhos com duplo revestimento PVC, acabamento industrial  $\equiv$  180 mm
- 1 alicate de ponta semi-redondas com estrias, extra-longas, punhos com duplo revestimento PVC, acabamento industrial  $\bullet$  160 mm
- 4 chaves para parafusos de perfil de fenda  $\bullet$  3x75 - 4x100 - 5,5x100 - 6,5x150 mm
- 3 chave para parafusos de perfil Phillips®  $\bullet$  PH0x60 - PH1x80 - PH2x100 mm
- 1 martelo para mecânico, tipo alemão 300 g
- 1 fita métrica 5 m
- 1 x - acto com lâmina divisível de 18 mm 170 mm

Refa. Nr.  
30  
32  
34  
36  
42  
96/SC9  
111E  
1048N  
1082G  
1128BMX  
1150G  
1166G  
1201E  
1202E  
1370  
1692  
1771



€

5915VU/1 565,00 059151024

Sortido recomendado em combinação com C8 - C9 - C10 - C10S - C11 - CP15 - CP15L - C16 - CP17 - CP17L - C18



## 5915VU/2

jogo de 49 ferramentas

### ► Universais

#### Nr. Peças/Descrição

- 8 6x7 - 8x9 - 10x11 - 12x13 - 14x15 - 16x17 - 18x19 - 20x22 mm
- 9 chaves macho hexagonal  $\odot$  1,5 - 2 - 2,5 - 3 - 4 - 5 - 6 - 8 - 10 mm
- 13 chaves de caixa sextavadas, quadra de 1/4"  $\odot$  4 - 4,5 - 5 - 5,5 - 6 - 7 - 8 - 9 - 10 - 11 - 12 - 13 - 14 mm
- 1 extensão, quadra 1/4" 150 mm
- 1 cardan com quadras macho e fêmea de 1/4"
- 1 extensão com punho, quadra macho de 1/4"
- 1 cabo T correção, quadra de 1/4"
- 1 roquete reversível, quadra de 1/4"  $\oplus$
- 1 alicate de charmeira fechada 250 mm
- 1 tesoura de electricista 147 mm
- 1 alicate combinado para trabalhos pesados, punhos com duplo revestimento PVC, acabamento industrial  $\equiv$  180 mm
- 4 chaves para parafusos de perfil de fenda  $\bullet$  3x75 - 4x100 - 5,5x150 - 6,5x150 mm
- 3 chave para parafusos de perfil Phillips®  $\oplus$  PH0x60 - PH1x80 - PH2x100 mm
- 1 martelo para mecânico, tipo alemão 300 g
- 1 fita métrica 3 m
- 1 10 lâminas divisível de 18 mm para x-acto ref. 1771, 1771BM, 1771HD
- 1 x - acto com lâmina divisível de 18 mm 170 mm

Refa. Nr.  
55/B8N  
96/SC9  
900  
900/21  
900/25  
900BG/30  
900/42  
900/55  
1048N  
1128BMX  
1150G  
1201E  
1202E  
1370  
1692  
1771RL  
1771



€

5915VU/2 489,00 059151027

Sortido recomendado em combinação com C7 - CP15 - C20 - C20L

## 5915VU/3

jogo de 74 ferramentas

### ► Utilização universal

#### Nr. Peças/Descrição

- 1 saca-troços  $\varnothing$  4 mm
- 1 punção de bico  $\varnothing$  4 mm
- 1 escopros planos 150 mm
- 14 chaves mistas, boca-luneta 6-7-8-10-11-12-13-14-15-16-17-19-22-24 mm
- 9 chaves macho hexagonal  $\odot$  1,5-10 mm
- 3 chaves macho sextavadas  $\odot$  4 - 5 - 6 mm
- 1 Chave ajustável 250 mm
- 13 chaves de caixa sextavadas, quadra de 1/2"  $\odot$  8-17 - 19 - 22 - 24 mm
- 1 extensão com quadras macho e fêmea de 1/2" 125 mm
- 1 extensão com quadras macho e fêmea de 1/2" 255 mm
- 1 cardan com quadras macho e fêmea de 1/2"
- 1 cabo T correção, quadra de 1/2"
- 1 roquete reversível, quadra de 1/2"  $\oplus$
- 8 chaves tubulares hexagonal, série ligeira 6x7 - 8x9 - 10x11 - 12x13 - 14x15 - 16x17 - 18x19 - 20x22 mm
- 2 passadores para chaves tubulares
- 1 Alicate de charmeira fechada 250 mm
- 1 alicate de pressão 240 mm
- 1 alicates de corte diagonal para serviços pesados, punhos anti-deslizantes com dupla camada em PVC, acabamento industrial  $\equiv$  160 mm
- 1 tesoura de electricista 147 mm
- 1 alicate combinado para trabalhos pesados, punhos com duplo revestimento PVC, acabamento industrial  $\equiv$  180 mm
- 1 alicate de ponta semi-redondas com estrias, extra-longas, punhos com duplo revestimento PVC, acabamento industrial  $\bullet$  160 mm
- 4 chaves para parafusos de perfil de fenda  $\bullet$  3x75 - 4x100 - 5,5x150 - 6,5x150 mm
- 3 chave para parafusos de perfil Phillips®  $\oplus$  PH0x60 - PH1x80 - PH2x100 mm
- 1 martelo para mecânico, tipo alemão 400 g
- 1 fita métrica 5 m
- 1 serrote com folha de serra bi-metálica
- 1 almotolia plástica 150 cc
- 1 x - acto com lâmina divisível de 18 mm 170 mm

Refa. Nr.  
31  
32  
34  
42  
96/SC9  
96T  
111E  
920A  
920/21  
920/22  
920/25  
920/42  
920/55  
935  
940  
1048VN  
1052  
1084G  
1128BMX  
1150G  
1166G  
1201E  
1202E  
1370  
1692  
1726  
1754  
1771



€

5915VU/3 1.040,00 059151028

Sortido recomendado em combinação com C7 - C9 - C10 - C10S - C11 - CP15L - C16 - CP17 - CP17L - C19 - C19L - C20 - C20L



**5915VU/4**

## jogo de 80 ferramentas

## ► Universais

## Nr. Peças/Descrição

- 1 saca-troços Ø 4 mm
- 1 punção de bico Ø 4 mm
- 1 escopros planos 150 mm
- 15 chaves mistas, boca-luneta 6-7-8-9-10-11-12-13-14-15-16-17-19-22-24 mm
- 9 chaves macho hexagonal Ø 1,5÷10 mm
- 1 Chave ajustável 250 mm
- 13 chaves de caixa sextavadas, quadra de 1/2" Ø 8÷17 - 19 - 22 - 24 mm
- 1 extensão com quadras macho e fêmea de 1/2" 255 mm
- 1 cardan com quadras macho e fêmea de 1/2"
- 1 cabo T correção, quadra de 1/2"
- 1 roquete reversível, quadra de 1/2" Ⓞ
- 17 chaves cachimbo 6 faces 6÷22 mm
- 1 alicate de charneira fechada 250 mm
- 1 alicate de pressão 240 mm
- 1 alicates de corte diagonal para serviços pesados, punhos em bi-matéria, acabamento industrial ≤ 160 mm
- 1 tesoura de electricista 147 mm
- 1 alicate combinado para trabalhos pesados, punhos bi-material, acabamento industrial = 180 mm
- 1 alicate de pontas semi-redondas com estrias, extra-longas, punhos bi-material, acabamento industrial ● 160 mm
- 4 chaves para parafusos de perfil de fenda ● 3x75 - 4x100 - 5,5x150 - 6,5x150 mm
- 3 chave para parafusos de perfil Phillips® ● PH0x60 - PH1x80 - PH2x100 mm
- 1 martelo para mecânico tipo francês 32 mm
- 1 fita métrica 5 m
- 1 serrote com folha de serra bi-metálica
- 1 almotolia plástica 150 cc
- 1 x - acto com lâmina divisível de 18 mm 170 mm

## Refa. Nr.

- 31
- 32
- 34
- 42
- 96/SC9
- 111E
- 920A
- 920/22
- 920/25
- 920/42
- 920/55
- 932/S17
- 1048N
- 1052
- 1084GBM
- 1128BMX
- 1150GBM
- 1166GBM
- 1201E
- 1202E
- 1370F
- 1692
- 1726
- 1754
- 1771

5915VU/4

€ 1.340,00 059151045

Sortido recomendado em combinação com C20 - C20L

**5915VU/5**

## jogo de 111 ferramentas

## ► Utilização universal

## Nr. Peças/Descrição

- 1 saca-troços Ø 4 mm
- 1 punção de bico Ø 4 mm
- 1 escopros planos 150 mm
- 17 chaves mistas, boca-luneta 6-7-8-9-10-11-12-13-14-15-16-17-18-19-20-21-22 mm
- 8 chaves de bocas 6x7-8x9-10x11-12x13-14x15-16x17-18x19-20x22 mm
- 9 chaves macho sextavadas com uma extremidade esférica cromadas Ø 1,5-2,2-5-3-4-5-6-8-10 mm
- 1 Chave ajustável 250 mm
- 39 jogo com 11 chaves de caixa sextavadas, 20 pontas e 8 acessórios
- 13 jogo com 11 chaves de caixa e 2 acessórios
- 1 alicate de charneira fechada 250 mm
- 1 alicate de pressão 240 mm
- 1 alicate de corte diagonal, punhos com duplo revestimento PVC, acabamento industrial ≤ 160 mm
- 1 turquês para cofragens 220 mm
- 1 tesoura de electricista 147 mm
- 1 alicate combinado para trabalhos pesados, punhos com duplo revestimento PVC, acabamento industrial = 180 mm
- 1 alicate de ponta semi-redondas com estrias, extra-longas, punhos com duplo revestimento PVC, acabamento industrial ● 160 mm
- 4 chaves para parafusos de perfil de fenda ● 3x75 - 4x100 - 5,5x100 - 6,5x150 mm
- 3 chave para parafusos de perfil Phillips® ● PH0x60 - PH1x80 - PH2x100 mm
- 1 martelo para mecânico, tipo alemão 300 g
- 1 martelo com batentes plásticos intermutáveis Ø 35 mm
- 1 fita métrica 3 m
- 1 limas perfis diversos
- 1 serrote com folha de serra bi-metálica 440 mm
- 1 x - acto com lâmina divisível de 18 mm 170 mm
- 1 lanterna de inspecção LED, em alumínio anodizado robusto

## Refa. Nr.

- 31
- 32
- 34
- 42
- 55/S8
- 96BPC/SC9
- 111E
- 900/C11
- 920A/C11
- 1048N
- 1052
- 1082G
- 1098
- 1128BMX
- 1150G
- 1166G
- 1201E
- 1202E
- 1370
- 1390
- 1692/3
- 1719BMA8/M
- 1726
- 1771BM
- 1833XS/2

5915VU/5

€ 1.320,00 059151046

Sortido recomendado em combinação com C12 - C41S - C41H - C42S - C42H



## 5915VU/AS

jogo de 68 ferramentas

### ► Utilização universal

#### Nr. Peças/Descrição

- 1 saca-troços Ø 4 mm
- 1 punção de bico Ø 4 mm
- 1 escopros planos 150 mm
- 13 chaves mistas, boca-luneta 1/4 - 5/16 - 3/8 - 7/16 - 1/2 - 9/16 - 5/8 - 11/16 - 3/4 - 13/16 - 7/8 - 15/16 - 1"
- 8 chaves de luneta curvatura profunda 1/4"±1"
- 9  $\bigcirc$  3/64"-3/8"
- 1 Chave ajustável 250 mm
- 11 chaves de caixa bocas de 12 faces quadra de 1/2"  $\bigcirc$  3/8 - 7/16 - 1/2 - 9/16 - 5/8 - 11/16 - 3/4 - 13/16 - 7/8 - 15/16 - 1"
- 1 extensão com quadras macho e fêmea de 1/2" 125 mm
- 1 extensão com quadras macho e fêmea de 1/2" 255 mm
- 1 cardan com quadras macho e fêmea de 1/2"
- 1 cabo T correção, quadra de 1/2"
- 1 roquete reversível, quadra de 1/2"  $\otimes$
- 1 alicate de charneira fechada 250 mm
- 1 alicate de pressão 240 mm
- 1 alicates de corte diagonal para serviços pesados, punhos em bi-matéria, acabamento industrial  $\nlessdot$  160 mm
- 1 tesoura de electricista 147 mm
- 1 alicate combinado para trabalhos pesados, punhos bi-material, acabamento industrial  $\equiv$  180 mm
- 1 alicate de pontas semi-redondas com estrias, extra-longas, punhos bi-material, acabamento industrial  $\bullet$  160 mm
- 4 chaves para parafusos de perfil de fenda  $\bullet$  3x75 - 4x100 - 5,5x150 - 6,5x150 mm
- 3 chave para parafusos de perfil Phillips®  $\oplus$  PH0x60 - PH1x80 - PH2x100 mm
- 1 martelo para mecânico, tipo alemão 300 g
- 1 fita métrica 5 m
- 1 serrote com folha de serra bi-metálica
- 1 almotolia plástica 150 cc
- 1 x - acto com lâmina divisível de 18 mm 170 mm

Refa. Nr.
31
32
34
42AS
90AS/8
96AS/SC9
111E
920AS
920/21
920/22
920/25
920/42
920/55
1048N
1052
1084GBM
1128BMX
1150GBM
1166GBM
1201E
1202E
1370
1692
1726
1754
1771

€ 5915VU/AS 1.140,00 059151032

Sortido recomendado em combinação com C10 - C20 - C20L



MC10



MC20

## 5927VU/M

jogo 108 ferramentas em tabuleiro maleável

### ► Utilização universal

#### Nr. Peças/Descrição

- 16 chaves mistas, boca-luneta 6-7-8-9-10-11-12-13-14-15-16-17-18-19-21-22 mm
- 1 Alicates de corte diagonal para trabalhos pesados  $\nlessdot$  160 mm
- 9 chaves macho hexagonal  $\bigcirc$  1,5-2-2,5-3-4-5-6-8-10 mm
- 1 alicate de pontas semi-redondas extra-longas  $\equiv$  180 mm
- 1 Alicates de pontas semi-redondas extralongas  $\bullet$  160 mm
- 3 chaves para parafusos de perfil de fenda  $\bullet$  3,5x100-5,5x150-6,5x150 mm
- 3 chave para parafusos de perfil Phillips®  $\oplus$  PH0x3x60-PH1x4,5x80-PH2x6x100 mm
- 31 jogo de 30 bits com porta-bits magnético de desengate rápido  $\bullet$   $\bigcirc$   $\oplus$   $\otimes$
- 1 alicate de charneira fechada 250 mm
- 1 martelo para mecânico, tipo alemão 300 mm
- 1 punção de bico 4 mm
- 1 buris 4 mm
- 13 chaves de caixa sextavadas, quadra de 1/4"  $\bigcirc$  4-4,5-5-5,5-6-7-8-9-10-11-12-13-14 mm
- 1 extensão, quadra 1/4" 150 mm
- 1 cardan com quadras macho e fêmea de 1/4"
- 1 extensão 1/4" com punho, série curta
- 1 cabo T correção, quadra de 1/4"
- 1 roquete reversível, quadra de 1/4"  $\otimes$
- 16 chaves de caixa sextavadas, quadra de 1/2"  $\bigcirc$  10-11-12-13-14-15-16-17-18-19-21-22-24-27-30-32 mm
- 1 cardan com quadras macho e fêmea de 1/2"
- 1 extensões com quadras macho e fêmea - 1/2" 125 mm
- 1 cabo T correção, quadra de 1/4"
- 1 roquete reversível, quadra de 1/2"  $\otimes$
- 1 chave de caixa porta-pontas com encaixe quadra fêmea

Refa. Nr.	TR
42	MC10
1084BM	MC10
96/SC9	MC10
1150BM	MC10
1166BM	MC10
1201E	MC10
1202E	MC10
861MX/A31	MC20
1048N	MC20
1370	MC20
32	MC20
36	MC20
900	MC20
900/21	MC20
900/25	MC20
900BG/30C	MC20
900/42	MC20
900/55	MC20
920A	MC20
920/25	MC20
920AN/125	MC20
900/42	MC20
920/55	MC20
895/1	MC20

€ 5927VU/M 1.120,00 059271021

Sortido recomendado em combinação com RSC22 - C27S - RSC23 - RSC23C





## 5957U-P

sortido de 133 ferramentas

### ► Manutenção universal

#### Nr. Peças/Descrição

Nr. Peças/Descrição	Refa. Nr.
6 saca-troços 2 + 8 mm	31/SP6
6 2 punções, 1 punção de bico e 3 escopros	38/SP6
17 chaves mistas 6+22 - 24 - 27 - 30 mm	42/S17X
12 chaves de bocas 6x7 + 30x32 mm	55/S12X
8 chaves macho hexagonal 2 + 10 mm	96T/S8
8 T9 + T40	97TX/SC8
1 Chave ajustável 250 mm	111E
13 chaves de caixa sextavadas, quadra de 1/2" ∅ 10 + 22 mm	920A/SB13
8 chaves de caixa sextavadas, quadra de 1/2" ∅ 23 + 32 mm	920A/SB8
7 chaves de caixa com ponta de perfil Phillips®	920LH/SB7
⊕ 1,2x65 - 1,2x8 - 1,6x9 - 2x12mm - PH1-PH2-PH3	
1 alicates de freios interiores com pontas direitas ∅ 180 mm	1032
1 alicates de freios interiores com pontas curvas ∅ 170 mm	1034
1 alicates de freios exteriores com pontas direitas ∅ 175 mm	1036
1 alicates de freios exteriores com pontas curvas ∅ 175 mm	1038
1 alicate de charneira fechada 250 mm	1048N
1 alicate de pressão 240 mm	1052
1 tesoura modelo americano 250 mm	1112
1 tesoura de electricista 147 mm	1128BMX
8 2,5x50 - 3x75 - 4x100 - 5,5x125 - 6,5x150 - PH0 - PH1 - PH2	1263/D8
2 martelo para mecânico, tipo alemão 300 - 600 g	1370
1 martelo com batentes plásticos intermutáveis ∅ 35 mm	1390
1 fita métrica 5 m	1692/5
1 pesca-peças magnético	1712E/2
1 rascador curvo 150 mm	1717A
1 rascador triangular 200 mm	1717B
5 limas perfis diversos 200 mm	1719BMA8/S5
1 Lata de óleo de pressão 200 cc	1751N
1 x - acto com lâmina divisível de 18 mm 170 mm	1771BM
1 extensão com quadras macho e fêmea de 1/2" 125 mm	920/21
1 extensão com quadras macho e fêmea de 1/2" 250 mm	920/22
1 cardan com quadras macho e fêmea de 1/2"	920/25
1 cabo T corrediço, quadra de 1/2"	920/42
1 roquete reversível, quadra de 1/2" ⊗	920/55
1 alavanca com extremidades chata e pontiaguda	963
1 Alicates de corte diagonal ∟ 160 mm	1082BM
1 Alicates de corte diagonal para trabalhos pesados ∟ 160 mm	1084BM
1 alicate de corte frontal, articulado, serviço pesado, grande esforço ∟ 180 mm	1092V
1 alicate de pontas semi-redondas extra-longas ≡ 180 mm	1150BM
1 Alicates de pontas semi-redondas extralongas ● 160 mm	1166BM
1 Alicates de pontas curvas semirredondas extralongas ● 160 mm	1168BM
2 chaves para parafusos de perfil de fenda ● 8x200 - 10x200 mm	1260
1 chaves para parafusos de perfil Phillips® ⊕ PH3 8x150mm	1262
1 paquímetro	1650
1 serrote com folha de serra bi-metálica 420 mm	1725

€



5957U-P

2.890,00 059571004

Sortido recomendado em combinação com C57SA - C57SB - C57SP - C55PS - C55PSE - RSC55 - RSC50 2.0 I - RSC50 2.0 L





**5958U**  
jogo de 85 ferramentas

► **Universais**

Nr. Peças/Descrição	Refa. Nr.
17 chaves mistas, boca-luneta 6÷22 mm	42
12 chaves macho sextavadas $\odot$ 2÷10 mm	96N/SC12
13 chaves de caixa sextavadas, quadra de 1/2" $\odot$ 10÷22 mm	920A/SB13
8 chaves de caixa sextavadas, quadra de 1/2" $\odot$ 23÷32 mm	920A/SB8
1 extensão com quadras macho e fêmea de 1/2" 125 mm	920/21
1 extensão com quadras macho e fêmea de 1/2" 255 mm	920/22
1 cardan com quadras macho e fêmea de 1/2"	920/25
1 cabo T correção, quadra de 1/2"	920/42
1 roquete reversível, quadra de 1/2" $\oplus$	920/55
1 alicates de freios interiores com pontas direitas $\odot$ 180 mm	1032
1 alicates de freios exteriores com pontas direitas $\bullet$ 175 mm	1036
1 alicate de charneira fechada 250 mm	1048N
1 alicate de pressão 240 mm	1052
1 Alicates de corte diagonal para trabalhos pesados $\nabla$ 160 mm	1084BM
1 tesoura de electricista 147 mm	1128BMX
1 alicate de pontas semi-redondas extra-longas $\equiv$ 180 mm	1150BM
1 Alicates de pontas semi-redondas extralongas $\bullet$ 160 mm	1166BM
7 chaves para parafusos de perfil de fenda	1260
$\bullet$ 3x75 - 3,5x100 - 4x125 - 5,5x150 - 6,5x150 - 8x200 - 10x200 mm	
4 chaves para parafusos de perfil Phillips®	1262/S4
$\oplus$ PH0x60 - PH1x80 - PH2x100 - PH3x150 mm	
1 martelo para mecânico, tipo alemão 300 g	1370
1 martelo com batentes plásticos intermutáveis $\varnothing$ 35 mm	1390
1 fita métrica 5 m	1692
5 jogo de 5 limas meia-murça, com punhos 200 mm	1719BMA...S5
1 serrote com folha de serra bi-metálica	1725
1 almotolia plástica 150 cc	1754
1 x - acto com lâmina divisível de 18 mm 170 mm	1771

€

5958U 1.470,00 059581008

Sortido recomendado em combinação com C58P - C45PRO 2.0 - RSC55 - RSC50 2.0 E - RSC50 2.0 F - RSC50 2.0 G - RSC50 2.0 H - RSC50 2.0 I - RSC50 2.0 L

## 5980U/BIKE

Sortido de 90 ferramentas

### ► Reparação de bicicletas

Nr. Peças/Descrição	Refa. Nr.
5 chaves mistas, boca-luneta 8-9-10-13-14 mm	42
9 chaves macho hexagonal com uma extremidade esférica, brunidas ○ 1,5-2-2,5-3-4-5-6-8-10 mm	96BP/SC9
8 chaves macho hexagonal 2-2,5-3-4-5-6-8-10 mm	96T/S8
8 chaves para parafusos de perfil Torx® ⊙ T8-T10-T15-T20-T25-T27-T30-T40	97TTX/S8
1 Chaves ajustáveis de grande abertura, cromadas, série curta 170 mm	111CM
1 corta - tubos para cobre e ligas leves	334
1 chaves dinamométricas 2÷10 Nm	605E
13 ○ 4-4,5-5-5,5-6-7-8-9-10-11-12-13-14 mm	900/SB13
1 extensão, quadra 1/4"	900/21
1 cardan com quadras macho e fêmea de 1/4"	900/25
1 roquete reversível, quadra de 1/4" Ⓢ	900/55
1 alicate de corte diagonal, punhos com duplo revestimento PVC, acabamento industrial 160 mm	1082G
1 tesoura de electricista 145 mm	1128BM
1 alicate combinado para trabalhos pesados, punhos com duplo revestimento PVC, acabamento industrial 180 mm	1150G
1 alicate de ponta semi-redondas com estrias, extra-longas, punhos com duplo revestimento PVC, acabamento industrial 180 mm	1166G
7 3x75-4x125-5,5x150-6,5x150-PH0x60-PH1x80-PH2x100 mm	1203E/D
1 martelo para mecânico, tipo alemão 300 g	1370
1 martelo com batentes plásticos intermutáveis Ø 35 mm	1390
1 paquímetro 150 mm	1650
1 fita métrica 3 m	1692/3
1 limas chatas meia-murças, com punho 200 mm	1719BMA...P
1 limas meia-cana meia-murças, com punho 200 mm	1719BMA...M
1 limas redondas meia-murças, com punho 200 mm	1719BMA...R
1 serrote com folha de serra bi-metálica 300 mm	1725
1 x - acto com lâmina divisível de 18 mm 170 mm	1771
1 ferramenta de verificação do desgaste das correntes 120 mm	3935
1 alicate para elos de correntes 170 mm	3937
7 sortido de 7 chaves de cones simples 13-14-15-16-17-18-19 mm	3952/S7
1 chave de boca para pedais 15 mm	3953
1 chave para raios, preta, 3,2 mm □	3961 3,2
1 chave para raios, verde, 3,3 mm □	3961 3,3
1 chave para raios, vermelha, 3,5 mm □ 3	3961 3,5
1 chave múltipla para raios, 3,2 - 4,0 mm □ 3,2 - 4,0 mm	3961U
1 ferramenta de bloqueio da cremalheira 289 mm	3967
1 alavanca metálica de pneus 200 mm	3969
3 kit de 3 alavancas de plástico, para pneus 113 mm	3969K3
1 alavanca para os freios do disco de travão 222 mm	3991
1 alinhador de discos de travão 234 mm	3992



€

5980U/BIKE

1.720,00 059801040

Sortido recomendado para usar com os itens C57S A - C57S B - C57SP - C55PSP



## 5980U/BIKE-M

jogo de 106 ferramentas para reparação e manutenção de bicicletas



### Nr. Peças/Descrição

Nr. Peças/Descrição	Refa. Nr.	TR
16 chaves mistas 6-7-8-9-10-11-12-13-14-15-16-17-18-19-20-21 mm	42	M05
8 chaves macho sextavadas 2-2,5-3-4-5-6-7-8 mm	96T	M50
5 chaves para parafusos de perfil Torx® TX10-TX15-TX20-TX25-TX30	97TTX	M55
1 Alicates de corte diagonal para trabalhos pesados 160 mm	1084	M137
1 alicate de pontas semi-redondas extra-longas 160 mm	1150	M137
1 Alicates de pontas semirredondas extralongas 160 mm	1166	M137
6 chaves para parafusos de perfil de fenda 2,5x50-3x75-4x100-5,5x125-6,5x150-8x200 mm	1201E	M213
1 chave para parafusos de perfil de fenda, série extra curta 4x30 mm	1201EN	M213
4 chave para parafusos de perfil Phillips® PH0x60-PH1x80-PH2x100-PH3x150 mm	1202E	M213
1 chave para parafusos de perfil Phillips®, série extra curta 4,5x30 mm	1202EN	M213
12 chaves para parafusos de perfil Torx®, com punho TX6-TX7-TX8-TX9-TX10-TX15-TX20-T25-TX27-TX30-TX40-TX45	1207E/TX	M213
1 busca - pólos	1253	M213
1 martelo para mecânico, tipo alemão 300 g	1370	M234
1 martelo com batentes plásticos intermutáveis Ø 35 mm	1390	M234
2 escopros planos 100-200 mm	35	M234
1 jogo de 5 limas meia-murça, com punhos 200 mm	1719BMA...S5	M236
1 fita métrica 5 m	1692	M294
1 mini serrote 250 mm	1725CR	M294
1 x - acto com lâmina divisível de 18 mm 170 mm	1771	M294
1 10 lâminas divisível de 18 mm para x-acto ref. 1771, 1771BM, 1771HD	1771RL	M294
1 Ferramenta para correntes compatível com correntes de 5 a 11 velocidades	3932U	M400
1 ferramenta de verificação do desgaste das correntes	3935	M400
1 alicate para elos de correntes	3937	M400
7 13-14-15-16-17-18-19 mm	3952	M400
1 chave para raios, preta, 3,2 mm □ 3,2 mm	3961 3.2	M400
1 chave para raios, verde, 3,3 mm □ 3,3 mm	3961 3.3	M400
1 chave para raios, vermelha, 3,5 mm □ 3,5 mm	3961 3.5	M400
1 chave múltipla para raios, 3,2 - 4,0 mm □ 3,2-4,0 mm	3961U	M400
1 alavanca metálica de pneus	3969	M400
1 kit de 3 alavancas de plástico, para pneus	3969K3	M400
1 Chave de extração do eixo de tração com 16 entalhes 39 mm	3973/1	M400
1 Chave de extração do eixo de tração com 16 entalhes 41 mm	3973/2	M400
1 Chave de extração do eixo de tração com 16 entalhes 46 mm	3973/3	M400
1 Chave extração do eixo de tração com 20 entalhes, com pino central, niquelada 31,5 mm	3973/4	M400
1 Chave de extração de cremalheira BMX, 4 pinos 35 mm	3984/1	M400
1 Chave de extração de cremalheira Shimano 22,8 mm	3984/2	M400
1 Chave de extração de cremalheira Shimano, cassette com pino guia 23,5 mm	3984/3	M400
1 Chave de extração de cremalheira Campagnolo, com pino guia 23 mm	3984/4	M400
1 alavanca para os freios do disco de travão	3991	M400
1 alinhador de discos de travão	3992	M400
1 Calibrador do suporte de mudanças	3921	M401
1 Extrator do crenque/braço do pedal	3948	M401
1 chave de boca para pedais	3953	M401
2 30x32-32x36 mm	3955	M401
1 ferramenta de bloqueio da cremalheira	3967	M401
1 Chave para parafusos de plástico Shimano	3971	M401



M05 M50 M55



M137 M234 M236 M294



M213



M400



M401

€

5980U/BIKE-M 2.230,00 059801050

Sortido recomendado para usar com os itens RSC23T - RSC24 6-7-8 - RSC24A - RSC24AXL - RSC24AXLP/7 - RSC24L/7 - RSC24L-CAB - RSC24AXL - RSC28 - C37 6-7-8 - C39 6-7-8 - C39MD - C39SM RSC55 - RSC50 2.0 - C59 - C58BC - C57



# 5988H/7M

Sortido de 333 ferramentas em tabuleiro maleável

## ► Reparação automóvel

Nr. Peças/Descrição



M125



M25



M105



M166



M231



M62



M78

- 13 ○ 8-9-10-11-12-13-14-15-16-17-19-21-22 mm
- 16 chaves de caixa série longa, boca hexagonal ○ 10-12-13-14-15-16-17-18-19-21-22-23-24-27-30-32 mm
- 7 chaves de caixa com quadra fêmea de 1/2", para parafusos com perfil Torx® ○ E12-E14-E16-E18-E20-E22-E24
- 10 chave de caixa com ponta macho sextavada ○ 5-6-6L-7-8-8L-10-10L-12-12L mm
- 13 chaves de caixa com ponta macho de perfil Torx® 1/2" ○ T20-T25-T27-T30-T30L-T40-T40L-T45-T50-T50L-T55-T60-T60L
- 8 chaves de caixa com ponta macho de perfil XZN® ○ 5-6-6-6L-8-8L-10-10L-12L mm
- 18 chaves mistas, boca-luneta 6-7-8-9-10-11-12-13-14-15-16-17-18-19-21-22-24-27 mm
- 7 chaves de luneta curvatura profunda 6x7-8x9-10x11-12x13-14x15x16x17-18x19 mm
- 1 adaptador de desengate rápido, 1/4", para chaves de roquete, 10mm
- 1 adaptador de desengate rápido, 3/8", para chaves de roquete, 13mm
- 1 adaptador de desengate rápido, 1/2", para chaves de roquete, 19mm
- 12 chaves boca/luneta com sistema de roquete 8-9-10-11-12-13-14-15-16-17-18-19 mm
- 9 chaves macho sextavadas com uma extremidade esférica cromadas ○ 1,5-2-2,5-3-4-5-6-8-10 mm
- 1 chave de caixa porta-pontas com encaixe quadra fêmea ○ 1/4-□1/4
- 1 chave de caixa porta-pontas com encaixe quadra fêmea ○ 1/4-□3/8
- 1 chave de caixa porta-pontas com encaixe quadra fêmea ○ 5/16-□1/2
- 13 chaves de caixa sextavadas, quadra de 1/4" ○ 4-4,5-5-5,5-6-7-8-9-10-11-12-13-14 mm
- 9 chaves de caixa série longa, boca sextavadas ○ 5-6-7-8-9-10-11-12-13 mm
- 4 chaves de caixa com ponta de perfil de fenda ● 0,8x4-1x5,5-1,2x6,51,2x8 mm
- 5 chaves de caixa com ponta sextavadas, quadra de 1/4" ○ 3-4-5-6-7 mm
- 4 chaves de caixa com ponta de perfil Phillips® ● PH1-PH2-PH3-PH4
- 7 chaves de caixa com ponta macho de perfil Torx® ○ T10-T15-T20-T25-T27-T30-T40
- 1 adaptador quadra fêmea de 1/4" para quadra macho de 3/8" □1/4-■3/8
- 3 extensão, quadra 1/4" 50-100-150 mm
- 1 cardan com quadras macho e fêmea de 1/4"
- 1 cabo T corredeiro, quadra de 1/4"
- 1 roquete reversível, quadra de 1/4" ⊕
- 1 extensão com punho, quadra macho de 1/4"
- 17 chaves de caixa, boca sextavadas 3/8" ○ 6-7-8-9-10-11-12-13-14-15-16-17-18-19-20-21-22 mm
- 1 redução quadra fêmea de 3/8" para quadra macho de 1/4" □3/8-■1/4
- 1 adaptador, chaves quadra 1/2" fêmea e 3/8" macho □3/8-■1/2
- 1 extensões com quadras macho e fêmea - 3/8" 125 mm
- 1 extensões com quadras macho e fêmea - 3/8" 250 mm
- 1 cardan com quadras macho e fêmea de 3/8"
- 1 cabo T corredeiro, quadra de 3/8"
- 1 roquete reversível, quadra de 3/8" 72 dentes ⊕
- 21 chaves de caixa sextavadas, quadra de 1/2" ○ 8-10-11-12-13-4-15-16-17-18-19-20-21-22-23-24-26-27-28-30-32 mm
- 2 extensões com quadras macho e fêmea - 1/2" 125-250 mm
- 1 redução quadra fêmea de 1/2" para quadra macho de 3/8" □1/2-■3/8
- 1 cardan com quadras macho e fêmea de 1/2"
- 1 cabo T corredeiro, quadra de 1/2"
- 1 roquete reversível, quadra de 1/2" ⊕
- 3 chaves de caixa 3/8" para velas ○ 16-17,8-20,8 mm
- 31 jogo de 30 bits com porta-bits magnético de desengate rápido ● ○ ⊕ ⊕ ⊕ ⊕
- 1 alicate de charmeira fechada 250 mm
- 1 Alicates de corte diagonal 160 mm
- 1 alicate de pontas semi-redondas extra-longas ■ 180 mm
- 1 Alicates de pontas chatas extralongas ■ 160 mm
- 5 chaves para parafusos de perfil Phillips® ● 3x75-4x100-5,5x100-6,5x150-8x150 mm
- 1 chave para parafusos de perfil de fenda série curta ● 6,5x30 mm
- 3 chaves para parafusos de perfil Phillips® ● PH1-PH2-PH3
- 1 chave para parafusos de perfil Phillips® série curt ● PH2
- 4 chaves para parafusos de perfil Torx® ○ T20-T25-T27-T30
- 6 saca-troços 2-3-4-5-6-8 mm
- 1 punção de bico 4 mm
- 3 escopros planos 125-150-75 mm
- 1 buris 125 mm
- 2 martelo para mecânico, tipo alemão 500-1000 g
- 1 lman telescópico com cabeça flexível
- 1 martelo com batentes plásticos intermutáveis Ø 35 mm
- 1 fita métrica 5 m
- 1 alicates de freios interiores com pontas direitas ○ 180 mm
- 1 alicates de freios interiores com pontas curvas ○ 170 mm
- 1 alicates de freios exteriores com pontas direitas ● 175 mm
- 1 alicates de freios exteriores com pontas curvas ● 175 mm
- 1 alicate de pontas semi - redondas longas, brunido punhos bi - material ● 140 mm
- 1 alicate de corte diagonal 125 mm
- 4 micro-chaves para parafusos de perfil de fenda ● 2,0-2,5-3,0-3,5 mm
- 2 micro-chaves para parafusos de perfil Phillips® ● 0-00
- 9 chaves para parafusos de perfil Torx® ○ T10-T15-T20-T25-T27-T30-T40-T45-T50
- 1 alicate de pressão 240 mm
- 1 alicates de pressão bicos longos 175 mm
- 1 grampos para oclusão de tubos
- 1 grampos para oclusão de tubos
- 1 grampos para oclusão de tubos
- 1 paquímetro
- 1 apalpa - folgas
- 1 raspador para embalagens
- 7 chave de caixa articulada 6x7-8x9-10x11-12x13-14x15-16x17-18x19 mm
- 1 cabo articulado com punho quadra de 1/2"
- 1 alavanca curva com punho 450 mm
- 1 espelho telescópico 670 mm
- 1 limas perfis diversos 200 mm
- 1 limas perfis diversos 200 mm
- 1 limas perfis diversos 200 mm
- 1 limas perfis diversos 200 mm
- 1 limas perfis diversos 200 mm
- 1 Escova de fios de aço

Refa. Nr.	TR
910AL	M125
920AL	M125
920FTX	M125
920PE	M125
920TX	M125
920XZN	M125
42	M25
90	M25
123Q1/4	M25
123Q3/8	M25
123Q1/2	M25
142	M25
96BPC/SC9	M105
895/1	M105
895/3	M105
895/6	M105
900	M105
900L	M105
900LP	M105
900ME	M105
900PH	M105
900TX	M105
900/16	M105
900/...	M105
900/25	M105
900/42	M105
900/55	M105
900BG/30	M105
910A	M105
910/15	M105
910/16	M105
910/21	M105
910/22	M105
910/25	M105
910/42	M105
910/55	M105
910/55	M105
956E	M105
861MAX/A31	M166
1048N	M166
1082BM	M166
1150BM	M166
1162BM	M166
1290	M166
1290N	M166
1292	M166
1292N	M166
1297TX	M166
31	M231
32	M231
34	M231
36	M231
1370	M231
1712TF	M231
1390	M231
1692	M125
1032	M62
1034	M62
1036	M62
1038	M62
1177BM	M62
1188BM	M62
1257LP	M62
1257PH	M62
977TX	M62
1052	M78
1058	M78
1481PL/A	M78
1481PL/B	M78
1481PL/C	M78
1650	M78
1708/20	M78
1716P	M78
80	M78
920/36A	M78
965	M78
1715	M231
1719BMA8/M	M231
1719BMA8/P	M231
1719BMA8/Q	M231
1719BMA8/R	M231
1719BMA8/T	M231
1737NX	M231

€

5988H/7M

5.900,00 059881087

Sortido recomendado para usar com os itens RSC24/8 - RSC24A/8 - RSC24AXL com 8-9 gavetas - RSC24AXL - RSC28 C37/8 - C39/8 - C59B - C55C8 - C55M8 - RSC55 - RSC50 2.0 - C58BC

## 5988L/4M

sortido de 273 ferramentas em módulo soft

### ► Reparações automóveis

Nr. Peças/Descrição



M105



M125



M25



M166

Nr. Peças/Descrição	Refa. Nr.	TR
13 chaves de caixa sextavadas, quadra de 1/4" ○ 4-4,5-5-5,5-6-7-8-9-10-11-12-13-14 mm	900	M105
9 chaves de caixa série longa, boca sextavadas ○ 5-6-7-8-9-10-11-12-13 mm	900L	M105
9 chaves macho sextavadas com uma extremidade esférica cromadas ○ 1,5-2-2,5-3-4-5-6-8-10 mm	96BPC/SC9	M105
1 chave de caixa porta-pontas com encaixe quadra fêmea	895/1	M105
1 chave de caixa porta-pontas com encaixe quadra fêmea	895/3	M105
1 chave de caixa porta-pontas com encaixe quadra fêmea	895/6	M105
5 chaves de caixa com ponta sextavadas, quadra de 1/4" ○ 3-4-5-6-7 mm	900ME	M105
4 chaves de caixa com ponta de perfil de fenda ● 0,8x4-1x5,5-1,2x6,5-1,2x8 mm	900LP	M105
4 chaves de caixa com ponta de perfil Phillips® ● PH1-PH2-PH3-PH4	900PH	M105
7 chaves de caixa com ponta macho de perfil Torx® ● T10-T15-T20-T25-T27-T30-T40	900TX	M105
1 adaptador quadra fêmea de 1/4" para quadra macho de 3/8" □ 1/4 - ■ 3/8	900/16	M105
3 extensão, quadra 1/4" 50-100-150 mm	900/...	M105
1 cardan com quadras macho e fêmea de 1/4"	900/25	M105
1 extensão com punho, quadra macho de 1/4"	900B/G30	M105
1 cabo T correção, quadra de 1/4"	900/42	M105
1 roquete reversível, quadra de 1/4" ⊕	900/55	M105
17 chaves de caixa, boca sextavadas 3/8" ○ 6-7-8-9-10-11-12-13-14-15-16-17-18-19-20-21-22 mm	910A	M105
1 redução quadra fêmea de 3/8" para quadra macho de 1/4" □ 3/8 - ■ 1/4	910/15	M105
1 adaptador, chaves quadra 1/2" fêmea e 3/8" macho □ 3/8 - ■ 1/2	910/16	M105
1 extensões com quadras macho e fêmea - 3/8" 125 mm	910/21	M105
1 extensões com quadras macho e fêmea - 3/8" 250 mm	910/22	M105
1 cardan com quadras macho e fêmea de 3/8"	910/25	M105
1 cabo T correção, quadra de 3/8"	910/42	M105
1 roquete reversível, quadra de 3/8" 72 dentes ⊕	910/55	M105
17 chaves de caixa sextavadas, quadra de 1/2"	920A	M105
○ 8-10-11-12-13-14-15-16-17-18-19-20-21-22-23-24-26-27-28-30-32 mm		
1 redução quadra fêmea de 1/2" para quadra macho de 3/8" □ 1/2 - ■ 3/8	920/15	M105
1 cardan com quadras macho e fêmea de 3/8"	910/25	M105
2 extensões com quadras macho e fêmea - 1/2" 125 - 250 mm	920AN	M105
1 cabo T correção, quadra de 1/2"	920/42	M105
1 roquete reversível, quadra de 1/2" ⊕	920/55	M105
3 chaves de caixa 3/8" para velas ○ 16-17,8-20,8 mm	956E	M105
13 ○ 8-9-10-11-12-13-14-15-16-17-19-21-22 mm	910AL	M125
10 chave de caixa com ponta macho sextavada ○ 5-6-6L-7-8-8L-10-10L-12-12L mm	920PE	M125
7 chaves de caixa com quadra fêmea de 1/2", para parafusos com perfil Torx®	920FTX	M125
○ E12-E14-E16-E18-E20-E22-E24		
13 chaves de caixa com ponta macho de perfil Torx® 1/2"	920TX	M125
○ T20-T25-T27-T30-T30L-T40-T40L-T45-T50-T50L-T55-T60-T60L		
8 chaves de caixa com ponta macho de perfil XZN® ○ 5-6-6L-8-8L-10-10L-12L mm	920XZN	M125
16 chaves de caixa série longa, boca hexagonal	920AL	M125
○ 10-12-13-14-15-16-17-18-19-21-22-23-24-27-30-32 mm		
1 fita métrica 5 m	1692/5	M125
18 chaves mistas, boca-luneta 6-7-8-9-10-11-12-13-14-15-16-17-18-19-21-22-24-27 mm	42	M25
7 chaves de luneta curvatura profunda 6x7-8x9-10x11-12x13-14x15-16x17-18x19 mm	90	M25
1 adaptador de desengate rápido, 1/4", para chaves de roquete, 10mm	123Q/14	M25
1 adaptador de desengate rápido, 3/8", para chaves de roquete, 13mm	123Q/8	M25
1 adaptador de desengate rápido, 1/2", para chaves de roquete, 19mm	123Q/12	M25
12 chaves boca/luneta com sistema de roquete 8-9-10-11-12-13-14-15-16-17-18-19 mm	142	M25
31 jogo de 30 bits com porta-bits magnético de desengate rápido ● ○ ⊕ ⊕ ⊕ ⊕	861MIX/A31	M166
1 alicate de chameira fechada 250 mm	1048N	M166
1 Alicates de corte diagonal 160 mm	1082BM	M166
1 alicate de pontas semi-redondas extra-longas ≡ 180 mm	1150BM	M166
1 Alicates de pontas chatas extralongas ≡ 160 mm	1162BM	M166
5 chaves para parafusos de perfil Phillips® ● 3x75-4x100-5,5x100-6,5x150-8x150 mm	1290	M166
1 chave para parafusos de perfil de fenda série curta ● 6,5x30 mm	1290N	M166
3 chaves para parafusos de perfil Phillips® ● 4,5x80-6x100-8x150 mm	1292	M166
1 chave para parafusos de perfil Phillips® série curt ⊕ 6x30 mm	1292N	M166
4 chaves para parafusos de perfil Torx® ● T20-T25-T27-T30	1297TX	M166

€

5988L/4M

4.160,00 059881088

Seleção recomendada em combinação com as referências RSC24 - RSC24A - RSC24AXL - RSC24AXLP/7 - RSC24AXXL - RSC24L/7 - RSC24L-CAB C37- C39 - C39T - C39SM - C39MD - RSC55 - RSC50 2.0 - C59 - C58BC - C57



# 5988U6/M

jogo de 214 ferramentas

## ► Utilização universal

### Nr. Peças/Descrição

- 22 chaves mistas, boca-luneta 6-7-8-9-10-11-12-13-14-15-16-17-18-19-20-21-22-24-27-30-32-36 mm
- 11 chaves de bocas 6x7-8x9-10x11-12x13-14x15-16x17-18x19-20x22-21x23-24x27-30x32 mm
- 11 chaves de luneta curvatura profunda 6x7-8x9-10x11-12x13-14x15-16x17-18x19-20x22-21x23-24x27-30x32 mm
- 9 chaves macho sextavadas com uma extremidade esférica cromadas  $\odot$  1,5-2-2,5-3-4-5-6-8-10 mm
- 6 chaves para parafusos de perfil de fenda  $\bullet$  2,5x50-3x75-4x100-5,5x125-6,5x150-8x200 mm
- 1 chave para parafusos de perfil de fenda, série extra curta  $\bullet$  4x30 mm
- 4 chaves para parafusos de perfil Phillips®  $\oplus$  PH0x60-PH1x80-PH2x100-PH3x150 mm
- 1 chave para parafusos de perfil Phillips®, série extra curta  $\oplus$  PH1x30 mm
- 12 chaves para parafusos de perfil Torx®, com punho  $\odot$  T6-T7-T8-T9-T10-T15-T20-T25-T27-T30-T40-T45
- 1 busca - pólos  $\bullet$
- 3 punções  $\varnothing$  2-3-4 mm
- 6 saca-troços  $\varnothing$  2-3-4-5-6-8 mm
- 1 punção de bico  $\varnothing$  4 mm
- 1 escopros planos 150 mm
- 2 escopros planos 200-250 mm
- 1 buris 125 mm
- 1 martelo para mecânico, tipo alemão 500 g
- 1 martelo com batentes plásticos intermutáveis  $\varnothing$  35 mm
- 1 fita métrica 3 m
- 1 lman telescópico com cabeça flexível
- 1 limas quadradas meia-murças, com punho 200 mm
- 1 limas triangulares meia-murças, com punho 200 mm
- 1 limas chatas meia-murças, com punho 200 mm
- 1 limas meia-cana meia-murças, com punho 200 mm
- 1 limas redondas meia-murças, com punho 200 mm
- 1 Escova de fios de aço
- 1 x - acto com lâmina divisível de 18 mm 170 mm
- 1 alicates de freios interiores com pontas direitas  $\odot$  180 mm
- 1 alicates de freios interiores com pontas curvas  $\odot$  170 mm
- 1 alicates de freios exteriores com pontas direitas  $\bullet$  175 mm
- 1 alicates de freios exteriores com pontas curvas  $\bullet$  175 mm
- 1 alicate de charmeira fechada 250 mm
- 1 alicate de pressão 240 mm
- 1 Alicates de corte diagonal  $\sphericalangle$  160 mm
- 1 turquês para cofragens 220 mm
- 1 tesoura modelo americano 250 mm
- 1 tesoura de electricista 145 mm
- 1 alicate de pontas semi-redondas extra-longas  $\equiv$  180 mm
- 1 Alicates de pontas semi-redondas extralongas  $\bullet$  160 mm
- 1 Alicates de pontas curvas semirredondas extralongas  $\bullet$  160 mm
- 1 chave de caixa porta-pontas com encaixe quadra fêmea
- 1 chave de caixa porta-pontas com encaixe quadra fêmea
- 1 chave de caixa porta-pontas com encaixe quadra fêmea
- 13 chaves de caixa sextavadas, quadra de 1/4"  $\odot$  4-4,5-5-5,5-6-7-8-9-10-11-12-13-14 mm
- 9 chaves de caixa série longa, boca sextavadas  $\odot$  5-6-7-8-9-10-11-12-13 mm
- 5 chaves de caixa com ponta sextavadas, quadra de 1/4"  $\odot$  3-4-5-6-7 mm
- 4 chaves de caixa com ponta de perfil de fenda  $\bullet$  0,8x4-1x5,5-1,2x6,5-1,2x8 mm
- 4 chaves de caixa com ponta de perfil Phillips®  $\oplus$  PH1-PH2-PH3-PH4
- 7 chaves de caixa com ponta macho de perfil Torx®  $\odot$  T10-T15-T20-T25-T27-T30-T40
- 1 extensão, quadra 1/4" 50 mm
- 1 extensão, quadra 1/4" 100 mm
- 1 extensão, quadra 1/4" 150 mm
- 1 cardan com quadras macho e fêmea de 1/4"
- 1 extensão com punho, quadra macho de 1/4"
- 1 cabo T correção, quadra de 1/4"
- 1 roquete reversível, quadra de 1/4"  $\oplus$
- 21 chaves de caixa sextavadas, quadra de 1/2"  $\odot$  8-10-11-12-13-14-15-16-17-18-19-20-21-22-23-24-26-27-28-30-32 mm
- 1 redução quadra fêmea de 1/2" para quadra macho de 3/8" 125 mm
- 1 cardan com quadras macho e fêmea de 1/2" 250 mm
- 1 extensões com quadras macho e fêmea - 1/2"
- 1 extensões com quadras macho e fêmea - 1/2"
- 1 cabo T correção, quadra de 1/2"
- 1 roquete reversível, quadra de 1/2"  $\oplus$
- 8 chaves de caixa com quadra fêmea de 1/2", para parafusos com perfil Torx®  $\odot$  10-12-14-16-18-20-22-24 mm
- 11 chaves de caixa série longa, boca hexagonal  $\odot$  10-12-13-14-15-16-17-18-19-21-22 mm

Refa. Nr.	TR
42	M01
55	M30
90	M30
96BPC/SC9	M30
1201E	M213
1201EN	M213
1202E	M213
1202EN	M213
1207E/TX	M213
1253	M213
30	M230
31	M230
32	M230
34	M230
35	M230
36	M230
1370	M230
1390	M230
1692	M230
1712TF	M230
1719BMA..Q	M230
1719BMA..T	M230
1719BMA..P	M230
1719BMA..M	M230
1719BMA..R	M230
1737NX	M230
1771	M230
1032	M129
1034	M129
1036	M129
1038	M129
1048N	M129
1052	M129
1082BM	M129
1098	M129
1112	M129
1128BM	M129
1150BM	M129
1166BM	M129
1168BM	M129
895/1	M100
895/3	M100
895/6	M100
900	M100
900L	M100
900ME	M100
900LP	M100
900PH	M100
900TX	M100
900/20	M100
900/20L	M100
900/21	M100
900/25	M100
900BG/30	M100
900/42	M100
900/55	M100
920A	M100
920/15	M100
920/25	M100
920AN/125	M100
920AN/250	M100
920/42	M100
920/55	M100
920FTX	M100
920AL	M100



M01



M30

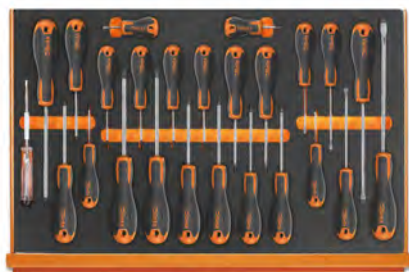

M213



M230



M129



M100

€

5988U6/M

3.490,00 059881430

Sortido recomendado em combinação com RSC24 com 8 gavetas - RSC24A com 8 gavetas - RSC24AXL z com 8-9 gavetas - RSC24AXLP/7 RSC24AXXL - RSC28 - C37 com 8 gavetas - C39 com 8 gavetas - C39SM - C39MD - RSC55 - RSC50 2.0 - C59B - C58BC



## 5935ET/1MB

jogo de 96 ferramentas para caixa de ferramentas C35, em tabuleiros maleáveis



MB65



MB64

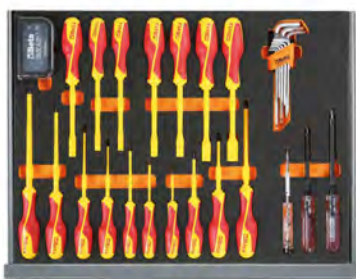

MB63

### ► Manutenção eletrotécnica

#### Nr. Peças/Descrição

- 1 alicate de pressão 240 mm
- 1 martelo para mecânico, tipo alemão 500 g
- 1 martelo com batentes plásticos intermutáveis Ø 35 mm
- 1 limas quadradas meia-murças, com punho 200 mm
- 1 limas chatas meia-murças, com punho 200 mm
- 1 limas triangulares meia-murças, com punho 200 mm
- 1 limas meia-cana meia-murças, com punho 200 mm
- 1 limas redondas meia-murças, com punho 200 mm
- 1 escopros planos 200 mm
- 1 alicates de freios interiores com pontas direitas ○ 180 mm
- 1 alicates de freios interiores com pontas curvas ○ 170 mm
- 1 alicates de freios exteriores com pontas direitas ● 175 mm
- 1 alicates de freios exteriores com pontas curvas ● 175 mm
- 1 Alicates de corte diagonal para trabalhos pesados † 160 mm
- 1 alicate de pontas semi-redondas extra-longas ≡ 180 mm
- 1 Alicates de pontas semi-redondas extralongas ● 160 mm
- 9 chaves macho sextavadas com uma extremidade esférica cromadas ○ 1,5-2-2,5-3-4-5-6-8-10 mm
- 1 chave de fenda com guia preênsil ● 4x125 mm
- 1 chave para parafusos de perfil Phillips® com guia preênsil ⊕ PH1x125 mm
- 1 busca - pólos ●
- 6 chaves de caixa com punho ○ 5,5-6-7-8-10-13 mm
- 4 chaves para parafusos de perfil Phillips®, 1000V ⊕ PH0x60-PH1x80-PH2x100-PH3x150 mm
- 6 chaves para parafusos de fenda sem cabeça, 1000V  
● 2,5x75-3x100-4x100-5,5x125-6x150-8x175 mm
- 31 jogo de 30 pontas com porta pontas magnético de desgatar rápido em caixa plástica ○ ● ⊕ ⊕ ⊕ ⊕
- 1 porta bits magnético, isolado, com punho de 2 componentes ®
- 8 chaves de bocas 6x7-8x9-10x11-12x13-14x15-16x17-18x19-20x22 mm
- 1 Alicate ajustável, charneira fechada, isolado 250 mm
- 1 alicate de corte diagonal 1000V † 140 mm
- 1 tesoura de electricista, lâminas direitas, com perfis de escareação 148 mm
- 1 alicate para cortar cabos de cobre e alumínio, com punhos isolados 230 mm
- 1 alicate de descarnar fio † 160 mm
- 1 alicates universais em cromado brilhante 1000V ≡ 180 mm
- 1 alicate de pontas semi - redondas extra - longas, 1000V ● 160 mm
- 1 alicates de pontas curvas semi-redondas extra-longas ● 160 mm
- 1 chaves ajustável, 1000V 250 mm
- 1 navalha, 1000V
- 1 pinça de pontas curvas estriadas, 1000V
- 1 alicate para cravar terminais isolados série ligeira

Refa. Nr.	TR
1052	MB65
1370	MB65
1390	MB65
1719BMA...Q	MB65
1719BMA...P	MB65
1719BMA...T	MB65
1719BMA...M	MB65
1719BMA...R	MB65
35	MB65
1032	MB65
1034	MB65
1036	MB65
1038	MB65
1084BM	MB65
1150BM	MB65
1166BM	MB65
96BPC/SC9	MB63
1250	MB63
1251	MB63
1253	MB63
943MQ	MB63
1272MQ	MB63
1274MQ	MB63
860MIX/A31	MB63
850MQ	MB63
55	MB64
1048MQ	MB64
1082MQ	MB64
1128BSX	MB64
1132MQ	MB64
1142MQ	MB64
1150MQ	MB64
1166MQ	MB64
1168MQ	MB64
110MQ	MB64
1777MQ	MB64
993MQ	MB64
1602	MB64

€

5935ET/1MB

2.110,00 059351332

Sortido recomendado em combinação com C35

## ► Manutenção electrotécnica

Nr. Peças/Descrição	Refa. Nr.
1 punção de bico Ø 4 m	32
1 escopros planos 150 mm	35
8 6x7 - 8x9 - 10x11 - 12x13 - 14x15 - 16x17 - 18x19 - 20x22 mm	55/B8N
8 Jogo de 8 chaves macho hexagonal, série longa Ø 2+10 mm	96LC/SC8
1 Chave ajustável 200 mm	111E
1 porta bits magnético, isolado, com punho de 2 componentes	850MQ
10 jogo de 10 bits com porta-bits magnético, em estojo de bolso	861MIX/A10
1 Alicata ajustável, charneira fechada, isolado 250 mm	1048MQ
1 Alicates de corte diagonal 160 mm	1082BM
1 tesoura de electricista, lâminas direitas, com perfis de escareação 148 mm	1128BSX
1 corta - cabos 170 mm	1132BM
1 alicate de pontas semi-redondas extra-longas 180 mm	1150BM
1 Alicates de pontas semi-redondas extralongas 160 mm	1166BM
1 Alicates de pontas curvas semirredondas extralongas 160 mm	1168BM
1 chave de fenda com guia preênsil 4x125 mm	1250
1 chave para parafusos de perfil Phillips® com guia preênsil PH1x125 mm	1251
1 busca - pólos	1253
5 chaves para parafusos de perfil de fenda 2,5x75 - 3,5x100 - 5,5x125 - 6,5x150 mm	1201E
1 chave para parafusos de perfil de fenda, série extra curta 4x30 mm	1201EN
4 chave para parafusos de perfil Phillips® PH0x60 - PH1x120 - PH2x150 - PH3x150 mm	1202E
1 chave para parafusos de perfil Phillips®, série extra curta PH2x30 mm	1202EN
4 chaves para parafusos de perfil Phillips®, 1000V PH0x60 - PH1x80 - PH2x100 - PH3x150 mm	1272MQ
5 chaves para parafusos de fenda sem cabeça, 1000V 5,5x125 - 3x100 - 4x100 - 6,5x150 - 8x175 mm	1274MQ
1 talhadeira chata com lâmina oblíqua	1343
1 martelo para mecânico, tipo alemão 300 g	1370
1 martelo com batentes plásticos intermutáveis Ø 35 mm	1390
1 alicata para cravar terminais isolados série ligeira 25 m	1602
1 fita métrica 5 m	BMESB1925NE
1 limas meia-cana meia-murças, com punho 200 mm	1692
1 limas redondas meia-murças, com punho 200 mm	1719BMA...M
1 serrote com folha de serra bi-metálica	1719BMA...R
1 navalha com entalhe para descarnar	1725
	1777BM



€

5980ET/A

1.060,00 059801083

Sortido recomendado em combinação com C12 - 2028VV - 2032TV - 2032VV





## 5980ET/B

sortido de 64 ferramentas

### ► Manutenção electrotécnica

#### Nr. Peças/Descrição

Nr. Peças/Descrição	Refa. Nr.
3 saca-troços Ø 2 - 3 - 4 mm	31
1 punção de bico Ø 4 mm	32
1 escopros planos 150 mm	34
8 6x7 - 8x9 - 10x11 - 12x13 - 14x15 - 16x17 - 18x19 - 20x22 mm	55/B8N
9 chaves macho sextavadas com uma extremidade esférica cromadas Ø 1,5 - 2 - 2,5 - 3 - 4 - 5 - 6 - 8 - 10 mm	96BPC/SC9
1 rebarbador de lâmina giratória com lâmina intermutável 150 mm	345SB
6 chaves de caixa com punho de boca hexagonal com punho 1000V Ø 5,5 - 6 - 7 - 8 - 10 - 13 mm	943MQ/S6
1 Alicate ajustável, charneira fechada, isolado 250 mm	1048MQ
1 alicate de corte diagonal 1000V $\leq$ 160 mm	1082MQ
1 tesoura de electricista, lâminas direitas, com perfis de escareação 148 mm	1128BSX
1 alicate para cortar cabos de cobre e alumínio, com punhos isolados 230 mm	1132MQ
1 alicate de descarnar fio $\leq$ 160 mm	1142MQ
1 alicates universais em cromado brilhante 1000V $\equiv$ 180 mm	1150MQ
1 alicate de pontas semi - redondas extra - longas, 1000V $\bullet$ 160 mm	1166MQ
1 busca - pólos $\bullet$	1253
3 chaves para parafusos de perfil Phillips®, 1000V $\oplus$ PH0x60 - PH1x80 - PH2x100 mm	1272MQ
4 chaves para parafusos de fenda sem cabeça, 1000V $\bullet$ 3x100 - 4x100 - 5,5x125 - 6,5x150 mm	1274MQ
1 martelo para mecânico, tipo alemão 300 g	1370
1 martelo com batentes plásticos intermutáveis Ø 35 mm	1390
1 alicate para cravar terminais isolados série ligeira	1602
1 réguas graduadas flexíveis em aço inoxidável 250 mm	1682
1 riscador, extremidades em carboneto de tungsténio 250 mm	1688
1 fita métrica 5 m	1692
1 nível com bolhas inquebráveis e corpo em perfil de alumínio anodizado 200 mm	1696
1 cinzéis para electricistas 10x200 mm	1701NE3
1 traçador de linhas em alumínio	1705
1 espelho quadrado 600 mm	1715FL/A
1 limas perfis diversos 200 mm	1719BMA8/M
1 limas perfis diversos 200 mm	1719BMA8/R
1 saca - molas	1723
1 serrote com folha de serra bi-metálica	1726BM
1 pincel	1738
1 alicate para abraçadeiras em Nylon	1743
1 almotolia plástica 150 cc	1754
100 abraçadeiras em nylon, cor preta resistente a UV 3,6x200 mm	1748N
100 abraçadeiras em nylon, cor preta resistente a UV 4,8x300 mm	1748M
1 x - acto com lâmina divisível de 18 mm 170 mm	1771BM
1 ferro de soldar bivalente 30 W	1814M
1 lanterna de inspecção LED, em alumínio anodizado robusto	1833XS/2

€  5980ET/B 1.470,00 059801084

Sortido recomendado em combinação com C12 - 2029/VV - 2033P/VV - 2036TV



## 5980MQ

jogo de 46 ferramentas

### ► Manutenção electrotécnica

#### Nr. Peças/Descrição

Nr. Peças/Descrição	Refa. Nr.
7 chave de boca simples, 1000V 10 - 12 - 13 - 14 - 17 - 19 - 22 mm	52MQ
1 chaves ajustável, 1000V 250 mm	110MQ
6 chaves de caixa com punho Ø 5,5 - 6 - 7 - 8 - 10 - 13 mm	943MQ
4 chaves em T com três extremidades macho hexagonal Ø 4 - 5 - 6 - 8 mm	951MQ
1 pinça de pontas curvas estriadas, 1000V	993MQ
1 Alicate ajustável, charneira fechada, isolado 250 mm	1048MQ
1 alicate de corte diagonal 1000V $\leq$ 160 mm	1082MQ
1 tesoura de electricista 145 mm	1128MQ
1 alicate de descarnar fio $\leq$ 160 mm	1142MQ
1 alicates universais em cromado brilhante 1000V $\equiv$ 180 mm	1150MQ
1 alicate de pontas curvas chatas extra-longas $\equiv$ 160 mm	1164MQ
1 alicate de pontas semi - redondas extra - longas, 1000V $\bullet$ 160 mm	1166MQ
1 busca - pólos $\bullet$	1253
4 chaves para parafusos de perfil Phillips®, 1000V $\oplus$ PH0x60 - PH1x80 - PH2x100 - PH3x150 mm	1272MQ
5 chaves para parafusos de fenda sem cabeça, 1000V $\bullet$ 3x100 - 4x100 - 5,5x125 - 6,5x150 - 8x175 mm	1274MQ
1 martelo para mecânico, tipo alemão 300 g	1370
1 martelo com batentes plásticos intermutáveis Ø 35 mm	1390
1 fita métrica 5 m	1692
1 cinzéis para electricistas 200 mm	1701NE/3
1 mini serrote, 1000V	1725MQ
2 navalha, 1000V	1777MQ
1 ferro de soldar bivalente 30 W	1814M
1 lanterna LED de elevada luminosidade, em alumínio anodizado robusto, até 500 lumens	1833S
1 ferramenta de teste de voltagem e continuidade, 1000 V	1760PT/N

€  5980MQ 1.950,00 059801257



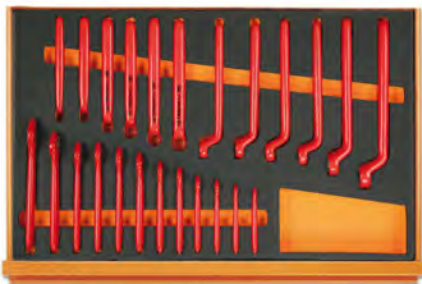

M49



M108



M161

## 5988 VHB-MQ

sortido de 66 ferramentas em módulos soft

### ► Manutenção eletrotécnica

#### Nr. Peças/Descrição

- 12 chave de boca simples, 1000V 7-8-10-11-12-13-14-15-16-17-19-22 mm
- 12 chaves de luneta 7-8-10-11-12-13-14-15-16-17-19-22 mm
- 4 chaves de caixa com ponta macho hexagonal  $\odot$  4-5-6-8 mm
- 11 chaves de caixa bi-sextavadas  $\odot$  7-8-10-11-12-13-14-15-16-17-19 mm
- 6 chaves de caixa de perfil Torx®  $\odot$  T15-T20-T25-T27-T30-T40
- 2 chaves de caixa de perfil XZN®  $\odot$  8-10 mm
- 1 extensão quadra 3/8" 125 mm
- 1 extensão quadra 3/8" 250 mm
- 1 punho em T, encabadouro 3/8"
- 1 roquete reversível quadra de 3/8"
- 1 tesoura de electricista 145 mm
- 1 Alicate ajustável, charneira fechada, isolado 250 mm
- 1 alicate de corte diagonal 1000V  $\leq$  160 mm
- 1 alicates universais em cromado brilhante 1000V  $\equiv$  180 mm
- 1 alicates de pontas extra-longas chatas  $\equiv$  160 mm
- 1 alicate de pontas curvas chatas extra-longas  $\equiv$  160 mm
- 4 chaves para parafusos de perfil Phillips®, 1000V  $\oplus$  PH0x60 - PH1x80 - PH2x100 - PH3x150 mm
- 4 chaves para parafusos de fenda sem cabeça, 1000V  $\bullet$  2,5x75 - 3x100 - 4x100 - 5,5x125 mm
- 1 navalha de descarnar cabo, isolada

Refa. Nr.	TR
52MQ	M49
89MQ	M49
910MQ/PE	M108
910MQ/B	M108
910MQ/TX	M108
910MQ/XZN	M108
910MQ/21	M108
910MQ/22	M108
910MQ/T	M108
910MQ/55	M108
1128MQ	M161
1048MQ	M161
1082MQ	M161
1150MQ	M161
1162MQ	M161
1164MQ	M161
1272MQ	M161
1274MQ	M161
1777MQ/U	M161

€



5988 VHB-MQ 3.270,00 059880300

Seleção recomendada em combinação com as referências RSC51- RSC23T - RSC24 - RSC24A - RSC24AXL - RSC24AXLP/7 - RSC24AXXL - RSC24L/7 - RSC24L-CAB - RSC28 - C37 - C39 - C39SM - C39MD - C39T - RSC55 - RSC50 2.0 - C59 - C58BC - C57

## 5980EL/A

sortido de 57 ferramentas

### ► Electronics

#### Nr. Peças/Descrição

- 13 4÷14 mm
- 9 chaves macho hexagonal  $\odot$  1,5÷10 mm
- 1 pinça de pontas finas, curvas e estriadas 130 mm
- 1 pinça com guia, pontas finas direitas e estriadas 150 mm
- 1 pinça cruzada de pontas largas, direitas e estriadas 155 mm
- 1 tesoura de electricista 147 mm
- 1 alicate para descarnar fio  $\leq$  160 mm
- 1 Alicates de pontas semi-redondas extralongas  $\bullet$  160 mm
- 1 alicate de pontas chatas longas  $\equiv$  140 mm
- 1 alicate de pontas semi - redondas longas curvas, bruniado punhos bi - material  $\bullet$  140 mm
- 1 alicate universal  $\bullet$  140 mm
- 1 alicate de corte diagonal raso  $\leq$  120 mm
- 1 alicate de corte diagonal  $\leq$  125 mm
- 1 chave de fenda com guia preênsil  $\bullet$  4x125 mm
- 1 chave para parafusos de perfil Phillips® com guia preênsil  $\oplus$  PH0x125 mm
- 8 micro-chaves
- 1 martelo para mecânico, tipo alemão 200 g
- 1 fita métrica 5 m
- 1 espelho telescópico
- 3 jogo de 3 limas
- 1 saca - molas
- 1 pincel
- 1 Oleador tipo caneta
- 1 x - acto com lâmina divisível de 18 mm 170 mm
- 1 pinça de pontas redondas estriadas com bloqueio, em aço inoxidável
- 1 ferro de soldar bivalente 25 W
- 1 bomba de dessoldar
- 1 lanterna de inspeção LED, em alumínio anodizado robusto

Refa. Nr.	TR
73/B13N	
96N/SC9	
991	
992	
998	
1128BMX	
1142BM	
1166BM	
1172BM	
1178BM/P	
1178BM	
1185BM	
1188BM	
1250	
1251	
1257LPH/S8	
1370	
1692	
1715	
1720/S3	
1723	
1738	
1756	
1771	
1002	
1814M	
1830T	
1833XS/2	

€



5980EL/A 1.060,00 059801081

Sortido recomendado em combinação com 2032TV - 2028/VV - 2033P/VV

**5980EL/B**

sortido de 98 ferramentas

**► Electrónica**

Nr. Peças/Descrição	Refa. Nr.
13 4÷14 mm	73/B13N
9 chaves macho hexagonal $\odot$ 1,5÷10 mm	96/SC9
8 chaves macho para parafusos de cabeça Torx®	97TX/BG8
$\odot$ T9 - T10 - T15 - T20 - T25 - T27 - T30 - T40	
1 Chave ajustável 150 mm	111E
18 jogo com 13 chaves hexagonais e 5 acessórios	900/C13-5
1 pinça de pontas finas, direitas e estriadas em aço inoxidável 130 mm	990
1 pinça de pontas finas, curvas e estriadas 130 mm	991
1 pinça com pontas curtas e arredondadas em aço inoxidável 120 mm	999A
1 tesoura de electricista 147 mm	1128BMX
1 alicate para descarnar fio, com ajuste 170 mm	1149F
1 alicate de pontas semi-redondas extra-longas $\equiv$ 180 mm	1150BM
1 alicate de pontas chatas longas $\equiv$ 140 mm	1172BM
1 alicate de pontas semi - redondas longas, brunido punhos bi - material $\bullet$ 140 mm	1177BM
1 alicate de pontas semi - redondas longas curvas, brunido punhos bi - material $\bullet$ 140 mm	1178BM/P
1 alicate de corte diagonal, raso pontas redondas punhos bi - material $\zeta$ 120 mm	1184BM
1 alicate de corte diagonal, raso, pontas finas e estriadas punhos bi - material $\zeta$ 120 mm	1186BM
1 alicate de corte frontal oblíquo, raso punhos bi - material $\zeta$ 130 mm	1191BM
8 micro-chaves	1257LPH/S8
1 busca - pólos $\bullet$	1253
1 chave para parafusos de perfil de fenda série curta $\bullet$ 6,5x30 mm	1290N
3 chaves para parafusos de perfil Phillips®	1292
$\oplus$ PH0x60 - PH1x80 - PH2x100 mm	
2 chave para parafusos de perfil Phillips® série curt	1292N
$\oplus$ PH1x30 - PH2x30 mm	
5 chaves para parafusos de perfil de fenda sem cabeça	1294
$\bullet$ 2,5x60 - 3x75 - 4x100 - 5x125 - 6,5x150 mm	
1 martelo para mecânico, tipo alemão 200 g	1370
1 régua graduada flexíveis em aço inoxidável 150 mm	1682
1 riscador, extremidades em carboneto de tungsténio 220 mm	1688
1 fita métrica 5 m	1692
1 espelho telescópico 670 mm	1715
1 Limas de calado $\bullet$	1720R
1 Limas de calado $\blacktriangle$	1720T
1 Limas de calado $\blacksquare$	1720P
1 saca - molas	1723
1 pincel	1738
1 Oleador tipo caneta	1756
1 x - acto com lâmina divisível de 18 mm 170 mm	1771BM
1 navalha com entalhe para descarnar	1777BM
1 pinça de pontas redondas estriadas com bloqueio, em aço inoxidável	1002
1 ferro de soldar bivalente 25W	1814M
1 bomba de dessoldar	1830T
1 lanterna de inspecção LED, em alumínio anodizado robusto	1833XS/2

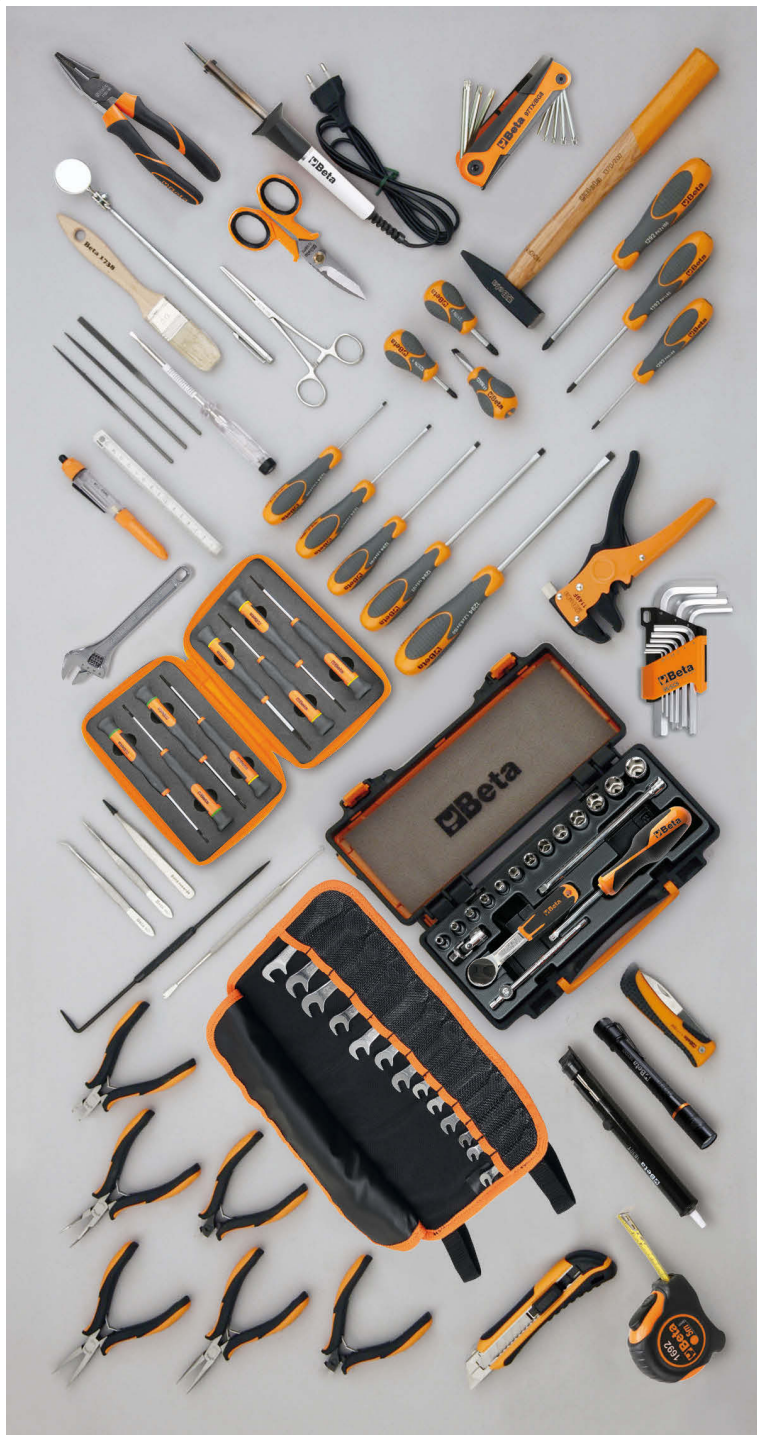

€

5980EL/B 1.490,00 059801082

Sortido recomendado em combinação com 2029/VV - 2033P/VV - 2036TV





**5980ID/1**  
jogo de 24 ferramentas

► **Canalização**

Nr. Peças/Descrição	Refa. Nr.
1 Chave ajustável 250 mm	111E
1 Ø 3÷28 mm	332/2
1 corta - tubos para cobre e ligas leves Ø 3+30 mm	334
1 Ø 0÷42 mm	342
1 140 mm	345SB2
2 320-410 mm	376
2 alicate de charneira fechada 175-250 mm	1048N
1 tesoura de electricista 147 mm	1128BMX
1 alicate combinado para trabalhos pesados, punhos bi-material, acabamento industrial 180 mm	1150GBM
4 chaves para parafusos de perfil de fenda ● 3x75-4x100-5,5x150-8x150 mm	1201E
2 chave para parafusos de perfil Phillips® PH1x80-PH2x100	1202E
1 martelo para mecânico, tipo alemão 500 g	1370
1 fita métrica em fibra de vidro 2 m	1690F
1 fita métrica 5 m	1692/5
1 nível com bolhas inquebráveis e corpo em perfil de alumínio anodizado 200 mm	1696
1 limas meia-cana meia-murças, com punho 200 mm	1719BMA...M
1 Lima chata paralela 200 mm	1719BM/RL
1 serrote com folha de serra bi-metálica	1725

5980ID/1

€ **630,00** 059801086

Sortido recomendado para usar com os itens 2009N/BV - C4 - C5 - C5S - C6T - C9MT

**Beta**



## 5989 VEM

jogo de 81 ferramentas para reparação e manutenção de veículos híbridos e elétricos

### ► Reparação auto

#### Nr. Peças/Descrição

- 1 tapete isolante
- 4 postes de plástico com base de enchimento
- 1 megômetro para teste de isolamento de alta tensão
- 1 ferramenta de teste de voltagem e continuidade, 1000 V
- 1 Cabos de substituição para multimetros digitais e braçadeiras amperométricas
- 1 Luvas isolantes compostas Gr. 10
- 1 Aparelho de teste pneumático para luvas isolantes
- 1 corrente de barreira em plástico
- 2 sinais de alerta em alumínio A1, A2
- 2 sinais de proibição D2, D3
- 12 chave de boca simples, 1000V 7-8-10-11-12-13-14-15-16-17-19-22 mm
- 12 chaves de luneta 7-8-10-11-12-13-14-15-16-17-19-22 mm
- 4 chaves de caixa com ponta macho hexagonal 4-5-6-8 mm
- 11 chaves de caixa bi-sextavadas 7-8-10-11-12-13-14-15-16-17-19 mm
- 6 chaves de caixa de perfil Torx® TX15-TX20-TX25-TX27-TX30-TX40
- 2 chaves de caixa de perfil XZN® M8-M10
- 1 extensão quadra 3/8" 140 mm
- 1 extensão quadra 3/8" 265 mm
- 1 punho em T, encabadouro 3/8" 200 mm
- 1 roquete reversível quadra de 3/8" 203 mm
- 1 Alicate ajustável, charneira fechada, isolado 250 mm
- 1 alicate de corte diagonal 1000V 160 mm
- 1 tesoura de electricista 145 mm
- 1 alicates universais em cromado brilhante 1000V 180 mm
- 1 alicates de pontas extra-longas chatas 160 mm
- 1 alicate de pontas curvas chatas extra-longas 160 mm
- 4 chaves para parafusos de perfil Phillips®, 1000V PH0-PH1-PH2-PH3
- 4 chaves para parafusos de fenda sem cabeça, 1000V 2,5x75-3x100-4x100-5.5x125 mm
- 1 navalha de descarnar cabo, isolada 190 mm

Refa. Nr.	TR
1995MQ/T	
7104 90	
1760OHM/2	
1760PT/N	
1760DGT-R3	
1997MQ/GM	
1996VPG	
7105 6	
7109A	
7109D	
52MQ	<b>M49</b>
89MQ	<b>M49</b>
910MQ/PE	<b>M108</b>
910MQ/B	<b>M108</b>
910MQ/TX	<b>M108</b>
910MQ/XZN	<b>M108</b>
910MQ/21	<b>M108</b>
910MQ/22	<b>M108</b>
910MQ/T	<b>M108</b>
910MQ/55	<b>M108</b>
1048MQ	<b>M161</b>
1082MQ	<b>M161</b>
1128MQ	<b>M161</b>
1150MQ	<b>M161</b>
1162MQ	<b>M161</b>
1164MQ	<b>M161</b>
1272MQ	<b>M161</b>
1274MQ	<b>M161</b>
1777MQ/U	<b>M161</b>

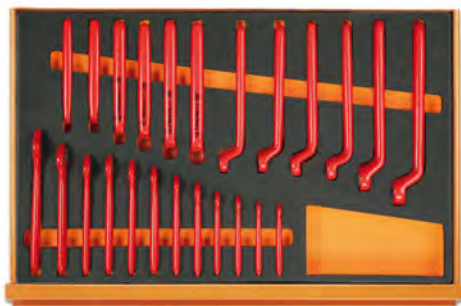

M49

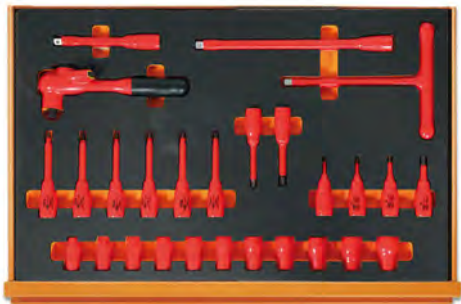

M108



M161



5989 VEM € 5.150,00 059890116

Jogo recomendado em combinação com o artigo RSC23T - RSC24 - RSC24A - RSC24AXL - RSC24AXLP/7 - RSC24AXXL - RSC24L/7 - RSC24L-CAB - RSC28 - C37 - C39 - C39T - C39SM - C39MD - RSC51 - RSC55 - RSC50 2.0 - C59 - C58BC - C57

## 5902MT

jogo de 106 ferramentas para agricultura, construção e máquinas de movimentação de terras

### ► Movimentação de terras

Nr. Peças/Descrição	Refa. Nr.
2 punções Ø 3 - 4 mm	30
2 saca-troços Ø 6 - 8 mm	31
1 punção de bico Ø 4 mm	32
2 escopros planos 150 - 200 mm	35
18 chaves mistas, boca-luneta 6÷14 - 17 - 19 - 22 - 24 - 27 - 30 - 32 - 36 - 41 mm	42
10 chaves de luneta curvatura profunda 6x7 - 8x9 - 10x11 - 12x13 - 14x15 - 16x17 - 18x19 - 20x22 - 24x27 - 30x32 mm	90
10 chaves macho hexagonal $\odot$ 1,5÷12 mm	96N/B10
17 chaves de caixa sextavadas, quadra de 1/2" $\odot$ 10÷22 - 24 - 27 - 30 - 32 mm	920A
1 extensão com quadras macho e fêmea de 1/2" 125 mm	920/21
1 extensão com quadras macho e fêmea de 1/2" 255 mm	920/22
1 cardan com quadras macho e fêmea de 1/2"	920/25
1 cabo T correção, quadra de 1/2"	920/42
1 roquete simples correção, quadra de 1/2" $\oplus$	920/50
11 chaves de caixa, quadra de 3/4" $\odot$ 22 - 24 - 27 - 30 - 32 - 36 - 41 - 46 - 50 - 55 - 60 mm	928A
1 extensão com quadras macho e fêmea de 3/4" 200 mm	928/21
1 cabo articulado, quadra de 3/4"	928/36A
1 cabo T correção, quadra de 3/4"	928/42
1 roquete reversível, quadra de 3/4" $\oplus$	928/55
1 alavanca com extremidades pontiaguda e em cunha	964
1 alicate de charneira fechada 250 mm	1048N
1 alicate de pressão maxilas recurvadas	1055
1 alicates de corte diagonal para serviços pesados, punhos em bi-matéria, acabamento industrial $\llcorner$ 160 mm	1084GBM
1 tesoura de electricista 147 mm	1128BMX
1 alicate combinado para trabalhos pesados, punhos bi-material, acabamento industrial $\equiv$ 180 mm	1150GBM
1 alicate de pontas semi-redondas com estrias, extra-longas, punhos bi-material, acabamento industrial $\bullet$ 160 mm	1166GBM
4 chaves para parafusos de perfil de fenda com sextavado auxiliar $\bullet$ 6,5x150 - 8x175 - 10x200 - 12x250 mm	1260E
3 chaves para parafusos de perfil Phillips® com sextavado auxiliar $\oplus$ PH2x150 - PH3x175 - PH4x200 mm	1262E
1 martelo com batente redondo e pena esférica 900 g	1377
1 martelo com batentes plásticos intermutáveis Ø 35 mm	1390
1 apalpa - folgas	1708/20
1 rascador triangular 200 mm	1717B
5 jogo de 5 limas meia-murça, com punhos 200 mm	1719BMA...S5
1 serrote com folha de serra bi-metálica	1725



€

5902MT 2.470,00 059021053

Sortido recomendado em combinação com RSC22 - RSC23 - RSC23C - C39T



## 5902MT/AS

jogo de 99 ferramentas para máquinas de movimentação de terras (CATERPILLAR)

### ► Movimentação de terras



Nr. Peças/Descrição	Refa. Nr.
2 punções Ø 3 - 4 mm	30
2 saca-troços Ø 6 - 8 mm	31
1 punção de bico Ø 4 mm	32
2 escopros planos 150 - 200 mm	35
20 chaves mistas, boca-luneta 1/4+1.1/2"	42AS
6 chaves de luneta curvatura profunda 1/4x5/16 - 3/8x7/16 - 1/2x9/16 - 5/8x3/4 - 11/16x13/16 - 7/8x15/16"	90AS
11 chaves macho hexagonal ○ 3/64+3/8"	96AS/B11
10 chaves de caixa bocas de 12 faces quadra de 1/2" ○ 7/16 - 1/2 - 9/16 - 5/8 - 11/16 - 3/4 - 13/16 - 7/8 - 15/16 - 1"	920AS
1 extensão com quadras macho e fêmea de 1/2" 125 mm	920/21
1 extensão com quadras macho e fêmea de 1/2" 255 mm	920/22
1 cardan com quadras macho e fêmea de 1/2"	920/25
1 cabo T correção, quadra de 1/2"	920/42
1 roquete simples correção, quadra de 1/2" ⊕	920/50
12 chaves de caixa hexagonal 1/4" ○ □ 3/4", 7/8 - 15/16 - 1 - 1.1/16 - 1.1/8 - 1.1/4 - 1.5/16 1.1/2 - 1.5/8 - 1.11/16 - 1.7/8 - 2"	928AS
1 extensão com quadras macho e fêmea de 3/4" 200 mm	928/21
1 cabo articulado, quadra de 3/4"	928/36A
1 cabo T correção, quadra de 3/4"	928/42
1 roquete reversível, quadra de 3/4" ⊕	928/55
1 alavanca com extremidades pontiaguda e em cunha	964
1 alicate de charneira fechada 250 mm	1048N
1 alicate de pressão maxilas recurvadas	1055
1 alicates de corte diagonal para serviços pesados, punhos em bi-matéria, acabamento industrial ≡ 160 mm	1084GBM
1 tesoura de electricista 147 mm	1128BMX
1 alicate combinado para trabalhos pesados, punhos bi-material, acabamento industrial ≡ 180 mm	1150GBM
1 alicate de pontas semi-redondas com estrias, extra-longas, punhos bi-material, acabamento industrial ● 160 mm	1166GBM
4 chaves para parafusos de perfil de fenda com sextavado auxiliar ● 6.5x150 - 8x175 - 10x200 - 12x250 mm	1260E
3 chaves para parafusos de perfil Phillips® com sextavado auxiliar ⊕ PH2x150 - PH3x175 - PH4x200 mm	1262E
1 martelo com batente redondo e pena esférica 900 g	1377
1 martelo com batentes plásticos intermutáveis Ø 35 mm	1390
1 apalpa - folgas 150 - 200 mm	1708/20
1 rascador triangular 200 mm	1717B
5 jogo de 5 limas meia-murça, com punhos 200 mm	1719BMA...S5
1 serrote com folha de serra bi-metálica	1725

€

5902MT/AS 2.570,00 059021054

Sortido recomendado em combinação com RSC22 - RSC23 - RSC23C - C39T



# 5904VG/2M

sortido de 170 ferramentas

## ► Reparação automóvel

Nr. Peças/Descrição

- 16 chaves mistas, boca-luneta 6+21 mm
- 5 chaves mistas, boca-luneta 22 - 24 - 27 - 30 - 32 mm
- 8 chaves macho sextavadas  $\odot$  2-2,5-3-4-5-6-7-8 mm
- 5 chaves para parafusos de perfil Torx®  $\odot$  T10-T15-T20-T25-T30
- 7 pontas macho hexagonal  $\odot$  4-5-6-7-8-10-12 mm
- 7 pontas hexagonais  $\odot$  4-5-6-7-8-10-12 mm
- 5 pontas para parafusos de perfil XZN®  $\odot$  5-6-8-10-12 mm
- 5 pontas com perfil XZN®  $\odot$  5-6-8-10-12 mm
- 7 pontas para parafusos de perfil Torx®  $\odot$  T20-T25-T30-T40-T45-T50-T55
- 6 pontas para parafusos de perfil Torx®  $\odot$  T25-T30-T40-T45-T50-T55
- 7 pontas para parafusos de perfil Tamper Resistant Torx®  $\odot$  T20-T25-T30-T40-T45-T50-T55
- 1 chaves de caixa porta-pontas para artigos 867
- 1 chaves de caixa porta-pontas para artigos 867
- 5 chaves para parafusos de perfil de fenda  $\bullet$  3x75 - 3,5x100 - 4x125 - 5,5x150 - 6,5x150 mm
- 3 chaves para parafusos de perfil Phillips®  $\oplus$  PH0x60 - PH1x80 - PH2x100 mm
- 1 chave para parafusos de perfil de fenda série curta  $\bullet$  4x30 mm
- 1 chaves para parafusos de perfil Phillips® série curta  $\oplus$  PH1x30 mm
- 5 bits para parafusos ranhurados, coloridos  $\bullet$  0,5x3 - 0,6x4,5 - 0,8x5,5 - 1x5,5 - 1,2x6,5 mm
- 8 bits sextavados para aparafusadoras eléctricas, coloridos  $\odot$  2 - 2,5 - 3 - 4 - 5 - 6 - 8 - 10 mm
- 5 bits para parafusos Phillips®, coloridos  $\oplus$  PH0 - PH1 - PH2 - PH3 - PH4
- 4 bits para parafusos Phillips®, coloridos  $\oplus$  PZ1 - PZ2 - PZ3 - PZ4
- 11 bits para parafusos Torx®, coloridos  $\odot$  T6-T7-T8-T9-T10-T15-T20-T25-T27-T30-T40
- 8 bits para parafusos invioláveis Torx®, coloridos  $\odot$  T9-T10-T15-T20-T25-T27-T30-T40
- 1 porta-pontas magnético com punho 230 mm
- 1 chave de bits reversível  $\oplus$  100 mm
- 1 extensão para porta-bits magnético 80 mm
- 1 adaptadores para aparafusadoras  $\blacksquare$  1/4 -  $\square$  1/4
- 2 escopros planos 100 - 200 mm
- 1 martelo para mecânico, tipo alemão 300 g
- 1 martelo com batentes plásticos intermutáveis  $\varnothing$  35 mm
- 1 extensões com quadras macho e fêmea - 1/2" 125 mm
- 1 extensões com quadras macho e fêmea - 1/2" 250 mm
- 1 cardan com quadras macho e fêmea de 1/2"
- 1 cabo T correção, quadra de 1/2"
- 1 roquete reversível, quadra de 1/2"  $\oplus$
- 19 chaves de caixa sextavadas, quadra de 1/2"  $\odot$  10+24 - 26 - 27 - 30 - 32 mm
- 1 alicate de pontas semi-redondas extra-longas  $\equiv$  180 mm
- 1 Alicates de pontas semi-redondas extralongas  $\bullet$  160 mm
- 1 Alicates de corte diagonal para trabalhos pesados  $\sphericalangle$  160 mm
- 1 alicates de freios interiores com pontas direitas  $\odot$  180 mm
- 1 alicates de freios interiores com pontas curvas  $\odot$  170 mm
- 1 alicates de freios exteriores com pontas direitas  $\bullet$  175 mm
- 1 alicates de freios exteriores com pontas curvas  $\bullet$  175 mm

Refa. Nr.	TR
42	M05
42	M06
96T	M50
97TTX	M55
867PE	M86
867PE/L	M86
867XZN	M86
867XZNL	M86
867TX	M86
867TXL	M86
867RTX	M86
867/1	M86
867/2	M86
1260	M208
1262	M208
1260N	M208
1262N	M208
860LP	M85
860PE	M85
860PH	M85
860PZ	M85
860TX	M85
860TX	M85
851SR	M85
860/55	M85
882P	M85
892/0	M85
35	M234
1370	M234
1390	M234
920AN/125	M83
920AN/250	M83
920/25	M83
920/42	M83
920/55	M83
920A	M83
1150BM	M136
1166BM	M136
1084BM	M136
1032	M145
1034	M145
1036	M145
1038	M145



M05 M06 VPM3



M50 M55 M86



M208 M85 M234



M83 M136 M145

€

5904VG/2M 1.980,00 059041198

Sortido recomendado em combinação com RSC23T - RSC24 - RSC24A - RSC24AXL - RSC24XLP/7 - RSC24AXL - RSC24L/7 - RSC24L-CAB - RSC28 - C37 - C39 - C39T - C39SM - C39MD RSC55 - RSC50 2.0 - C59 - C58BC - C57

## 5904VG/2T

jogo de 99 ferramentas

### ► Reparação automóvel

Nr. Peças/Descrição

- 16 chaves mistas, boca-luneta 6÷21 mm
- 5 chaves mistas, boca-luneta 22 - 24 - 27 - 30 - 32 mm
- 19 chaves de caixa sextavadas, quadra de 1/2"  $\odot$  10÷24 - 26 - 27 - 30 - 32 mm
- 5 chaves de caixa com ponta hexagonal, quadra de 1/2"  $\odot$  5 - 6 - 8 - 10 - 12 mm
- 1 extensão com quadras macho e fêmea de 1/2" 125 mm
- 1 extensão com quadras macho e fêmea de 1/2" 255 mm
- 1 cardan com quadras macho e fêmea de 1/2"
- 1 cabo T corrediço, quadra de 1/2"
- 1 roquete reversível, quadra de 1/2"  $\odot$
- 1 alicate de charneira fechada 250 mm
- 1 alicate de pressão 240 mm
- 1 Alicates de corte diagonal para trabalhos pesados  $\nabla$  160 mm
- 1 Alicates de pontas semirredondas extralongas  $\bullet$  160 mm
- 1 alicate de pontas semi-redondas extra-longas  $\equiv$  180 mm
- 1 alicates de freios interiores com pontas direitas  $\odot$  180 mm
- 1 alicates de freios exteriores com pontas direitas  $\bullet$  175 mm
- 1 alicates de freios interiores com pontas curvas  $\odot$  170 mm
- 1 alicates de freios exteriores com pontas curvas  $\bullet$  175 mm
- 2 escopros planos 100 - 200 mm
- 1 martelo para mecânico, tipo alemão 300 g
- 1 martelo com batentes plásticos intermutáveis  $\varnothing$  35 mm
- 4 chaves para parafusos de perfil de fenda  $\bullet$  3x75 - 4x100 - 5,5x150 - 6,5x150 mm
- 3 chaves para parafusos de perfil Phillips®  $\odot$  PH0x60 - PH1x80 - PH2x100 mm
- 8 chaves de bocas 6x7 - 8x9 - 10x11 - 12x13 - 14x15 - 16x17 - 18x19 - 20x22 mm
- 9 chaves macho hexagonal  $\odot$  1,5 - 2 - 2,5 - 3 - 4 - 5 - 6 - 8 - 10 mm
- 6 chaves macho sextavadas  $\odot$  2 - 2,5 - 3 - 4 - 5 - 6 mm
- 6 chaves para parafusos de perfil Torx®  $\odot$  T10 - T15 - T20 - T25 - T27 - T30

Refa. Nr.	TR
42	T05
42	T06
920A	T80
920ME	T80
920/21	T80
920/22	T80
920/25	T80
920/42	T80
920/55	T80
1048N	T153
1052	T153
1084	T138
1166	T138
1150	T138
1032	T145
1036	T145
1034	T145
1038	T145
35	T234
1370	T234
1390	T234
1260	T208
1262	T208
55	T33
96/SC9	T33
96T	T52
97TTX	T55



T05 T06 T80



T153 T138 T145 T234



T208 T33 T52 T55

€

5904VG/2T

1.680,00 059041191

Sortido recomendado em combinação com RSC51 - RSC23T - RSC24 - RSC24A - RSC24AXL - RSC24AXLP/7 - RSC24AXL - RSC24L/7 - RSC24L-CAB - RSC28 - C37 - C39 - C39SM - C39MD - C39T - RSC55 - RSC50 2.0 - C59 - C58BC - C57



# 5904VG/3

jogo de 132 ferramentas

## ► Reparação automóvel

Nr. Peças/Descrição

Refa. Nr.

6	Ø 2+8 mm	31/B6N
1	punção de bico Ø 5 mm	32
1	escopros planos 200 mm	35
17	chaves mistas, boca-luneta 6+22 mm	42
8	chaves de bocas 6x7 - 8x9 - 10x11 - 12x13 - 14x15 - 16x17 - 18x19 - 20x22 mm	55
9	chaves macho hexagonal Ø 1,5 - 2 - 2,5 - 3 - 4 - 5 - 6 - 8 - 10 mm	96N/SC9
11	chaves macho hexagonal Ø 2+10 mm	96T/SP11
13	chaves macho com perfil Torx® T6+T50	97TX/B13
1	Chave ajustável 300 mm	111E
13	chaves de caixa sextavadas, quadra de 1/2" Ø 10+22 mm	920A/SB13
1	extensão com quadras macho e fêmea de 1/2" 125 mm	920/21
1	extensão com quadras macho e fêmea de 1/2" 255 mm	920/22
1	cardan com quadras macho e fêmea de 1/2"	920/25
1	cabo T correção, quadra de 1/2"	920/42
1	roquete simples correção, quadra de 1/2" Ⓢ	920/50
6	chaves de caixa hexagonais com cardan e cabo em T Ø 8 - 10 - 12 - 13 - 17 - 19 mm	952
1	alavanca curva com punho 450 mm	965
2	alicates de freios interiores com pontas direitas Ø 180 - 225 mm	1032
2	alicates de freios interiores com pontas curvas Ø 170 - 210 mm	1034
2	alicates de freios exteriores com pontas direitas Ø 175 - 225 mm	1036
2	alicates de freios exteriores com pontas curvas Ø 175 - 220 mm	1038
1	alicate de charneira fechada 250 mm	1048N
1	alicate de pressão 240 mm	1057A
1	alicates de corte diagonal para serviços pesados, punhos em bi-matéria, acabamento industrial 200 mm	1084GBM
1	alicate de corte frontal, articulado, serviço pesado, grande esforço 200 mm	1092V
1	tesoura modelo americano 250 mm	1112
1	tesoura de electricista 147 mm	1128BMX
1	alicate combinado para trabalhos pesados, punhos bi-material, acabamento industrial 180 mm	1150GBM
4	chaves para parafusos de perfil de fenda ● 3x75 - 4x100 - 5,5x125 - 6,5x150 mm	1260
1	chave para parafusos de perfil de fenda série curta ● 6,5x30 mm	1260N
2	chaves para parafusos de perfil de fenda com sextavado auxiliar ● 8x175 - 10x200 mm	1260E
3	chaves para parafusos de perfil Phillips® ⊕ PH0x100 - PH1x120 - PH2x100 mm	1262
1	chaves para parafusos de perfil Phillips® série curta ⊕ PH2x30 mm	1262N
1	chaves para parafusos de perfil Phillips® com sextavado auxiliar ⊕ PH3x175mm	1262E
1	chave para parafusos de perfil Phillips® série longa ⊕ PH2x400 mm	1262L
1	chave para parafusos de perfil de fenda sem cabeça série longa ● 6,5x400 mm	1264L
1	martelo para mecânico, tipo alemão 500 g	1370
1	martelo com batentes plásticos intermutáveis Ø 45 mm	1390
1	chaves para filtros de óleo com cinta metálica regulável	1491
1	apalpa - folgas	1708/20
5	jogo de 5 limas meia-murça, com punhos 200 mm	1719BMA...S5
1	serrote com folha de serra bi-metálica	1726BM
1	Lata de óleo de pressão 200 cc	1751N



€ 

5904VG/3 2.630,00 059041062

Sortido recomendado em combinação com RSC24 - RSC24A - RSC24AXL - RSC24AXLP/7 - RSC24AXXL - RSC24L/7 - RSC24L-CAB  
C37 - C39 com 7 - 8 gavetas - RSC55 - RSC50 2.0 - C59 - C58BC - C57



## 5904VG/3T

sortido de 102 ferramentas

### ► Reparação automóvel

Nr. Peças/Descrição

Refa. Nr. TR



T199 T202 T83



T145 T153 T137 T234



T52 T33 T05 T06



T63 VP5

- 21 chaves mistas, boca-luneta 6-7-8-9-10-11-12-13-14-15-16-17  
18-19-20-21-22-24-27-30-32 mm
- 8 chaves de bocas 6x7-8x9-10x11-12x13-14x15-16x17-18x19-20x22 mm
- 9 chaves macho hexagonal  $\odot$  1,5+10 mm
- 6 chaves macho sextavadas  $\odot$  2-2,5-3-4-5-6 mm
- 8 chaves de caixa hexagonais com cardan e cabo em T  $\odot$  7-8-10-12-13-14-17-19 mm
- 19 chaves de caixa sextavadas, quadra de 1/2"  $\odot$  10-11-12-13-14-15-16-17-18-19  
20-21-22-23-24-26-27-30-32 mm
- 1 extensão com quadras macho e fêmea de 1/2" 125 mm
- 1 extensão com quadras macho e fêmea de 1/2" 255 mm
- 1 cardan com quadras macho e fêmea de 1/2"
- 1 cabo T corrediço, quadra de 1/2" 305 mm
- 1 roquete reversível, quadra de 1/2"  $\odot$
- 1 Alicates de corte diagonal para trabalhos pesados  $\ddagger$  160 mm
- 1 alicate de pontas semi-redondas extra-longas  $\equiv$  180 mm
- 1 Alicates de pontas semi-redondas extralongas  $\bullet$  160 mm
- 1 alicates de freios interiores com pontas direitas  $\odot$  180 mm
- 1 alicates de freios interiores com pontas curvas  $\odot$  170 mm
- 1 alicates de freios exteriores com pontas direitas  $\bullet$  175 mm
- 1 alicates de freios exteriores com pontas curvas  $\bullet$  175 mm
- 1 alicate de pressão 240 mm
- 1 alicate de charneira fechada 250 mm
- 7 chaves para parafusos de perfil de fenda  
 $\bullet$  2,5x50 -3x75 - 3,5x100 - 4x125 -5,5x100 - 5,5x150 - 6,5x150 mm
- 6 chaves para parafusos de perfil Phillips®  
 $\odot$  PH0x60 - PH0x100 - PH1x80 - PH1x120 - PH2x100 - PH2x150 mm
- 2 escopros planos 100-200 mm
- 1 martelo para mecânico, tipo alemão 300 g
- 1 martelo com batentes plásticos intermutáveis  $\varnothing$  35 mm
- 1 vazio

- 42 T05-T06
- 55 T33
- 96/SC9 T33
- 96T T52
- 952 T63
- 920A T83
- 920/21 T83
- 920/22 T83
- 920/25 T83
- 920/42 T83
- 920/55 T83
- 1084BM T137
- 1150BM T137
- 1166BM T137
- 1032 T145
- 1034 T145
- 1036 T145
- 1038 T145
- 1052 T153
- 1048N T153
- 1260 T199
- 1262 T202
- 35 T234
- 1370 T234
- 1390 T234
- VP5

€

5904VG/3T

1.940,00 059041510

Sortido recomendado em combinação com RSC23T - RSC24 - RSC24A - RSC24AXL - RSC24AXLP/7 - RSC24AXXL - RSC24L/7 - RSC24L-CAB - RSC28 - C37 - C39 - C39MD - C39SM - C39T - RSC55 - RSC50 2.0 - C59 - C58BC - C57

# 5904VG/5T

jogo de 160 ferramentas

## ► Reparação automóvel

### Nr. Peças/Descrição

- 5 chaves de caixa com ponta hexagonal, quadra de 1/2" ⌀ 5 - 6 - 8 - 10 - 12 mm
- 1 extensão com quadras macho e fêmea de 1/2" 125 mm
- 1 extensão com quadras macho e fêmea de 1/2" 255 mm
- 1 cardan com quadras macho e fêmea de 1/2"
- 1 cabo T corrediço, quadra de 1/2"
- 1 roquete reversível, quadra de 1/2" Ⓢ
- 19 chaves de caixa sextavadas, quadra de 1/2" ⌀ 10+24 - 26 - 27 - 30 - 32 mm
- 16 chaves mistas, boca-luneta 6÷21 mm
- 5 chaves mistas, boca-luneta 22 - 24 - 27 - 30 - 32 mm
- 8 chaves de caixa hexagonais com cardan e cabo em T ⌀ 7 - 8 - 10 - 12 - 13 - 14 - 17 - 19 mm
- 1 vazio
- 1 alicates de freios interiores com pontas direitas ⌀ 180 mm
- 1 alicates de freios interiores com pontas curvas ⌀ 170 mm
- 1 alicates de freios exteriores com pontas direitas ● 175 mm
- 1 alicates de freios exteriores com pontas curvas ● 175 mm
- 7 chaves para parafusos de perfil Phillips®
- 2,5x50 - 3x75 - 3,5x100 - 4x125 - 5,5x100 - 5,5x150 - 6,5x150 mm
- 5 chaves para parafusos de perfil Torx® Ⓢ T25 - T27 - T30 - T40 - T45
- 6 chaves macho sextavadas ⌀ 2 - 2,5 - 3 - 4 - 5 - 6 mm
- 8 chaves de bocas 6x7 - 8x9 - 10x11 - 12x13 - 14x15 - 16x17 - 18x19 - 20x22 mm
- 9 chaves macho hexagonal ⌀ 1,5 - 2 - 2,5 - 3 - 4 - 5 - 6 - 8 - 10 mm
- 3 chaves para parafusos de perfil Phillips® ● 8x150 - 8x200 - 10x200 mm
- 2 chave para parafusos de perfil de fenda série curta ● 4x30 - 6,5x30 mm
- 6 chaves para parafusos de perfil Phillips®
- PH0x60 - PH0x100 - PH1x80 - PH1x120 - PH2x100 - PH2x150 mm
- 2 chaves para parafusos de perfil Phillips® ● PH3x150 - PH4x200 mm
- 2 chave para parafusos de perfil Phillips® série curt ● PH1x30 - PH2x30 mm
- 2 escopros planos 100 - 200 mm
- 1 martelo para mecânico, tipo alemão 300 g
- 1 martelo com batentes plásticos intermutáveis Ø 35 mm
- 1 alicate de pontas semi-redondas extra-longas ≡ 180 mm
- 1 Alicates de pontas semi-redondas extralongas ● 160 mm
- 1 Alicates de corte diagonal para trabalhos pesados ≤ 160 mm
- 6 pontas para aparafusadoras, para parafusos perfil Torx® Ⓢ T6+T15
- 8 pontas para aparafusadoras, para parafusos perfil Torx® Ⓢ T20+T55
- 1 chave de caixa porta-pontas com encaixe quadra fêmea
- 1 chave de caixa porta-pontas com encaixe quadra fêmea
- 895/1 T112
- 895/6 T112
- 900FTX T112
- 920FTX T112
- 920TX T112
- 1048N T153
- 1052 T153

Refa. Nr.	TR
920ME	T80
920/21	T80
920/22	T80
920/25	T80
920/42	T80
920/55	T80
920A	T80
42	T05
42	T06
952	T63
VP6	VP6
1032	T145
1034	T145
1036	T145
1038	T145
1290	T170
1297TX	T176
96T	T52
55	T33
96N/SC9	T33
1290	T171
1290N	T171
1292	T172
1292	T173
1292N	T173
35	T234
1370	T234
1390	T234
1150BM	T137
1166BM	T137
1084BM	T137
861TX	T112
866TX	T112
895/1	T112
895/6	T112
900FTX	T112
920FTX	T112
920TX	T112
1048N	T153
1052	T153



T80 T05 T06



T63 VP6



T145 T170 T176 T52



T33 T171 T172 T173



T234 T137 T112 T153

€

5904VG/5T

2.690,00 059041196

Sortido recomendado em combinação com RSC24 com 7 - 8 gavetas - RSC24A com 7 - 8 gavetas - RSC24AXL com 7 - 8 gavetas - RSC24AXLP/7 - RSC24AXLL - RSC24L/7 - RSC24L-CAB - RSC28 - C37 com 7 - 8 gavetas - C39 com 7 - 8 gavetas - C39MD - C39SM - RSC55 - RSC50 2.0 - C59 - C58BC - C57



## 5905VG/1

jogo de 94 ferramentas para máquina de movimentação de terras (CATERPILLAR)

### ► Reparação automóvel

Nr. Peças/Descrição	Refa. Nr.
1 punções Ø 4 mm	30
6 Ø 2 - 3 - 4 - 5 - 6 - 8 mm	31/B6N
1 punção de bico Ø 4 mm	32
1 escopros planos 150 mm	34
1 buris 150 mm	36
10 chaves mistas, boca-luneta 6÷22 mm	42
10 chaves macho hexagonal 1,5÷12 mm	96/B10
1 Chaves ajustáveis com escalas, fosfatadas 300 mm	111EN
12 chave de caixa com punho, modelo longo 4÷14 mm	943BX
1 alavanca curva com punho 450 mm	965
1 alicate de charneira fechada 250 mm	1048N
1 alicate de pressão 240 mm	1052
1 alicate de pressão para soldadura 280 mm	1060AL
1 alicates de corte diagonal para serviços pesados, punhos em bi-matéria, acabamento industrial 160 mm	1084GBM
1 turquês para cofragem 250 mm	1098PL
1 tesoura articulada, lâminas direitas	1122
1 tesoura de electricista 147 mm	1128BMX
1 alicate combinado para trabalhos pesados, punhos bi-material, acabamento industrial 180 mm	1150GBM
1 chave para parafusos de perfil Dzus®	1201E/DZ
4 chaves para parafusos de perfil de fenda	1260
● 3x75 - 4x100 - 5,5x150 - 6,5x150 mm	
1 chave para parafusos de perfil de fenda série curta ● 4x30 mm	1260N
2 chaves para parafusos de perfil de fenda com sextavado auxiliar	1260E
● 10x175 - 12x200 mm	
3 chaves para parafusos de perfil Phillips®	1262
● PH0x60 - PH1x80 - PH2x100 mm	
1 chaves para parafusos de perfil Phillips® série curta ● PH1x30 mm	1262N
1 chaves para parafusos de perfil Phillips® com sextavado auxiliar	1262E
● PH3x175 mm	
7 chaves para parafusos de perfil Torx®	1267TX
○ T6 - T8 - T10 - T15 - T20 - T25 - T30	
1 encontrador tipo virgula 1350 g	1303
1 encontrador curvo	1305
1 encontrador tipo tacão	1306
1 encontrador tipo trilho	1310
1 encontrador redondo duplo com almofadas convexa e plana	1314
1 colher estreita simples	1326
1 colher larga simples	1327
1 colher dupla pescoço de cisne com mesas largas	1330
1 armação flexível com lima de chapeiro 9"	1338A
1 talhadeira chata com cortante direito e punho de protecção	1342PM
1 martelo com cabeça convexa redonda e pena	1345
1 martelo com cabeça redonda serrilhada e quadrada plana Ø 40 mm	1357Z/45
1 martelo para mecânico, tipo alemão 300 g	1370
1 martelo com batentes plásticos intermutáveis Ø 35 mm	1390
1 fita métrica 5 m	1692



€

5905VG/1 2.380,00 059051058

Sortido recomendado em combinação com C25



**5905VG/2**

jogo de 118 ferramentas

► **Reparação automóvel**

Nr. Peças/Descrição	Refa. Nr.
6 jogo de 2 punções, 1 punção de bico, 2 escopros planos e 1 buril em bolsa de poliéster	38/B6N
13 chaves mistas, boca-luneta 6+14 - 17 - 19 - 22 - 24 mm	42
13 chaves de bocas 6x7 - 8x9 - 10x11 - 12x13 - 14x15 - 16x17 - 18x19 - 20x22 - 21x23 - 24x26 - 25x28 - 27x29 - 30x32 mm	55
3 chaves curvas de lunetas 11x13 - 14x17 - 19x22 mm	83
10 chaves macho hexagonal $\odot$ 1,5+12 mm	96N/B10
6 chaves para parafusos de perfil Torx® $\odot$ T10 - T15 - T20 - T25 - T30 - T40	97TTX
2 chaves de impacto hexagonal, quadra de 1/2" $\odot$ 17 - 19 mm	720
20 chaves de caixa sextavadas, quadra de 1/2" $\odot$ 10+24 - 26 - 27 - 28 - 30 - 32 mm	920A
1 extensão com quadras macho e fêmea de 1/2" 125 mm	920/21
1 extensão com quadras macho e fêmea de 1/2" 255 mm	920/22
1 cardan com quadras macho e fêmea de 1/2"	920/25
1 cabo T correção, quadra de 1/2"	920/42
1 roquete reversível, quadra de 1/2" $\oplus$	920/55
8 chaves de caixa hexagonais com cardan e cabo em T $\odot$ 7 - 8 - 10 - 11 - 13 - 14 - 17 - 19 mm	952
1 chave em T para velas com cardan, série normal	959
1 chave em cruz para porcas de rodas $\odot$ 17x19x22x $\blacksquare$ 1/2"	979
1 alicates de freios interiores com pontas direitas $\odot$ 180 mm	1032
1 alicates de freios interiores com pontas curvas $\odot$ 170 mm	1034
1 alicates de freios exteriores com pontas direitas $\bullet$ 175 mm	1036
1 alicates de freios exteriores com pontas curvas $\bullet$ 175 mm	1038
1 alicate de carneira fechada 250 mm	1048N
1 alicate de pressão 240 mm	1052
1 alicates de corte diagonal para serviços pesados, punhos em bi-matéria, acabamento industrial $\sphericalangle$ 160 mm	1084GBM
1 tesoura articulada, lâminas direitas 250 mm	1122
1 tesoura de electricista 147 mm	1128BMX
1 alicate combinado para trabalhos pesados, punhos bi-material, acabamento industrial $\equiv$ 180 mm	1150GBM
1 alicate de pontas semi-redondas com estrias, extra-longas, punhos bi-material, acabamento industrial $\bullet$ 160 mm	1166GBM
8 chaves para parafusos de perfil de fenda $\bullet$ 2,5x50 - 3x75 - 3,5x100 - 4x125 - 5,5x125 - 6,5x150 - 8x200 - 10x200 mm	1260
2 chaves para parafusos de perfil de fenda com sextavado auxiliar $\bullet$ 10x200 - 12x250 mm	1260E
1 chave para parafusos de perfil de fenda série curta $\bullet$ 6,5x30 mm	1260N
4 chaves para parafusos de perfil Phillips® $\oplus$ PH0x60 - PH1x80 - PH2x100 - PH3x150 mm	1262
1 martelo para mecânico, tipo alemão 400 g	1370
1 martelo com batentes plásticos intermutáveis $\varnothing$ 35 mm	1390
1 chaves para filtros de óleo com cinta metálica regulável	1491
1 verificador de tensão 3+48 V	1498

€

5905VG/2

2.230,00 059051044

Sortido recomendado em combinação com C25

# 5908VG/2T

sortido de 214 ferramentas

## ► Reparação automóvel

Nr. Peças/Descrição

Refa. Nr. TR



T05 T06 T31



T80 T145 T146



T167 T168  
+96N +1771



T63 T209



T55 T111 T113 T236



T264 T234 T153 T138



T105 T106 VP6



- 16 chaves mistas, boca-luneta 6÷21 mm 42 T05
- 5 chaves mistas, boca-luneta 22 - 24 - 27 - 30 - 32 mm 42 T06
- 5 saca-troços Ø 2 - 3 - 4 - 5 - 6 mm 31 T31
- 1 punção de bico Ø 4 mm 32 T31
- 12 chaves de bocas 6x7 - 8x9 - 10x11 - 12x13 - 14x15 - 16x17 55 T31
- 18x19 - 20x22 - 21x23 - 24x26 - 27x29 - 30x32 mm
- 9 chaves macho hexagonal Ø 1,5 - 2 - 2,5 - 3 - 4 - 5 - 6 - 8 - 10 mm 96N/SC9 T31
- 5 chaves de caixa com ponta hexagonal, quadra de 1/2" Ø 5 - 6 - 8 - 10 - 12 mm 920ME T80
- 1 extensão com quadras macho e fêmea de 1/2" 125 mm 920/21 T80
- 1 extensão com quadras macho e fêmea de 1/2" 255 mm 920/22 T80
- 1 cardan com quadras macho e fêmea de 1/2" 920/25 T80
- 1 cabo T correção, quadra de 1/2" 920/42 T80
- 1 roquete reversível, quadra de 1/2" 920/55 T80
- 19 chaves de caixa sextavadas, quadra de 1/2" Ø 10÷24 - 26 - 27 - 30 - 32 mm 920A T80
- 1 alicates de freios interiores com pontas direitas Ø 180 mm 1032 T145
- 1 alicates de freios interiores com pontas curvas Ø 170 mm 1034 T145
- 1 alicates de freios exteriores com pontas direitas Ø 175 mm 1036 T145
- 1 alicates de freios exteriores com pontas curvas Ø 175 mm 1038 T145
- 1 alicates de freios interiores com pontas direitas Ø 140 mm 1032 T146
- 1 alicates de freios interiores com pontas direitas Ø 225 mm 1032 T146
- 1 alicates de freios exteriores com pontas direitas Ø 140 mm 1036 T146
- 1 alicates de freios exteriores com pontas direitas Ø 225 mm 1036 T146
- 9 chaves para parafusos de perfil de fenda 1260 T167
- 3x75 - 3x100 - 4x100 - 4x150 - 5,5x100 - 5,5x150 - 6,5x150 - 8x150 - 10x200 mm
- 2 chave para parafusos de perfil de fenda série curta ● 4x30 - 6,5x30 mm 1262 T168
- 7 chaves para parafusos de perfil Phillips®
- PH0x60 - PH0x100 - PH1x80 - PH1x120 - PH2x100 - PH2x150 - PH3x150 mm 1262N T168
- 2 chaves para parafusos de perfil Phillips® série curta ● PH1x30 - PH2x30 mm 952 T63
- 8 chaves de caixa hexagonais com cardan e cabo em T Ø 7 - 8 - 10 - 12 - 13 - 14 - 17 - 19 mm 1262L T209
- 2 chave para parafusos de perfil Phillips® série longa ● PH1x400 - PH2x400 mm 1264L T209
- 3 chave para parafusos de perfil de fenda sem cabeça série longa ● 3x300 - 4x400 - 5x400 mm 97TTX T55
- 6 chaves para parafusos de perfil Torx® ● T10-T15-T20-T25-T27-T30 720 T111
- 12 chaves de impacto hexagonal, quadra de 1/2" Ø 10-13-17-18-19-21-22-24-27-30-32 mm 720/21 T111
- 1 extensão com quadras macho e fêmea de 1/2" 125 mm 720LC T111
- 3 Ø 17-19-21 920PE T113
- 5 chave de caixa com ponta macho sextavada Ø 5L - 6L - 7L - 8L - 10L 920TX T113
- 4 chaves de caixa com ponta macho de perfil Torx® 1/2" ● T40L - T45L - T55L - T70L 920XZN T113
- 3 chaves de caixa com ponta macho de perfil XZN® Ø M6L - M8L - M12L 1719BMA8/S5 T236
- 5 limas perfis diversos 200 mm 1491 T264
- 1 chaves para filtros de óleo com cinta metálica regulável 110 mm 1494 T264
- 1 chave quadra para bujões de óleo ■ 10 mm 1494E T264
- 7 chave macho sextavada para bujões de óleo Ø 8-9-10-11-12-14-17 mm 1494Q T264
- 4 chave macho quadra para bujões de óleo Ø 8-9,5-12-13 mm 1494T T264
- 1 chave macho triangular para bujões de óleo Δ 9,5 mm 1494XZN T264
- 1 chave macho perfil XZN® para bujões de óleo Ø M 16 1496C T264
- 1 chave para bujões de óleo ■ 8 x ■ 10 mm 35 T234
- 2 escopros planos 100 - 200 mm 1370 T234
- 1 martelo para mecânico, tipo alemão 300 g 1390 T234
- 1 martelo com batentes plásticos intermutáveis Ø 35 mm 1048N T153
- 1 alicate de charmeira fechada 250 mm 1052 T153
- 1 alicate de pressão 240 mm 1150 T138
- 1 alicate de pontas semi-redondas extra-longas ■ 180 mm 1166 T138
- 1 Alicates de pontas semirredondas extralongas ● 160 mm 1084 T138
- 1 Alicates de corte diagonal para trabalhos pesados † 160 mm 928A T105
- 11 chaves de caixa, quadra de 3/4" Ø 22-24-27-30-32-34-36-38-41-46-50 mm 928/21 T106
- 1 extensão com quadras macho e fêmea de 3/4" 200 mm 928/22 T106
- 1 extensão com quadras macho e fêmea de 3/4" 380 mm 928/42 T106
- 1 cabo T correção, quadra de 3/4" 450 mm 928/55 T106
- 1 roquete reversível, quadra de 3/4" 96N VP6
- 1 vazio 96N VP6
- 4 chaves macho hexagonal Ø 13-14-17-19 mm 111E 965
- 1 Chave ajustável 300 mm 1112
- 1 alavanca curva com punho 1370
- 1 tesoura modelo americano 250 mm 1708/20
- 1 tesoura de electricista 147 mm 1712
- 1 martelo para mecânico, tipo alemão 1000 g 1715
- 1 apalpa - folgas 1717B
- 1 pesca peças 1726
- 1 espelho telescópico 1737NX
- 1 rascador triangular 200 mm 1751N
- 1 serrote com folha de serra bi-metálica 440 mm 1771
- 1 Escova de fios de aço
- 1 Lata de óleo de pressão 200 cl
- 1 x - acto com lâmina divisível de 18 mm 170 mm

5908VG/2T 4.520,00 059081017

Sortido recomendado em combinação com RSC28



## 5935VG/1MB

jogo de 98 ferramentas para caixa de ferramentas C35, em tabuleiros maleáveis



MB12



MB39



MB46

### ► Reparação automóvel

#### Nr. Peças/Descrição

- 21 chaves mistas, boca-luneta 6-7-8-9-10-11-12-13-14-15-16-17-18-19-20-21-22-24-27-30-32 mm
- 8 chaves de bocas 6x7-8x9-10x11-12x13-14x15-16x17-18x19-20x22 mm
- 1 alicate de carneira fechada 250 mm
- 4 chaves para parafusos de perfil de fenda 3x75-4x100-5x125-6,5x150 mm
- 3 chaves para parafusos de perfil Phillips PH0x60-PH1x80-PH2x100 mm
- 6 chaves para parafusos de perfil Torx T8-T10-T15-T20-T25-T30
- 9 chaves macho sextavadas com uma extremidade esférica cromadas
- 6 chaves macho sextavadas 2-2,5-3-4-5-6
- 1 alicate de pressão 240 mm
- 19 chaves de caixa sextavadas, quadra de 1/2" 10-11-12-13-14-15-16-17-18-19-20-21-22-23-24-26-27-30-32 mm
- 1 extensão com quadras macho e fêmea de 1/2" 125 mm
- 1 extensão com quadras macho e fêmea de 1/2" 250 mm
- 1 cardan com quadras macho e fêmea de 1/2"
- 1 cabo T corrediço, quadra de 1/2"
- 1 roquete reversível, quadra de 1/2"
- 5 chave de caixa com ponta macho sextavada 5-6-8-10-12 mm
- 1 alicates de freios interiores com pontas direitas 180 mm
- 1 alicates de freios interiores com pontas curvas 170 mm
- 1 alicates de freios exteriores com pontas direitas 175 mm
- 1 alicates de freios exteriores com pontas curvas 175 mm
- 1 escopros planos 200 mm
- 1 Alicates de corte diagonal para trabalhos pesados 160 mm
- 1 alicate de pontas semi-redondas extra-longas 180 mm
- 1 Alicates de pontas semi-redondas extralongas 160 mm
- 1 martelo para mecânico, tipo alemão 500 g
- 1 martelo com batentes plásticos intermutáveis Ø 35 mm

Refa. Nr.	TR
42	MB12
55	MB12
1048N	MB12
1260	MB46
1262	MB46
1267TX	MB46
96BPC/SC9	MB46
96T	MB46
1052	MB46
920A	MB39
920/21	MB39
920/22	MB39
920/25	MB39
920/42	MB39
920/55	MB39
920PE	MB39
1032	MB39
1034	MB39
1036	MB39
1038	MB39
35	MB39
1084BM	MB39
1150BM	MB39
1166BM	MB39
1370	MB39
1390	MB39

€

5935VG/1MB 1.980,00 059351321

Sortido recomendado em combinação com C35

## 5940SBK

Sortido de 125 ferramentas

### ► Reparação de motocicletas

#### Nr. Peças/Descrição

- 1 punções Ø 2 mm
- 1 punção de bico Ø 4 mm
- 1 escopros planos 125 mm
- 10 chaves mistas, boca-luneta 6 - 7 - 8 - 10 - 11 - 12 - 13 - 14 - 17 - 19 mm
- 6 chaves de bocas 6x7 - 8x9 - 10x11 - 12x13 - 14x15 - 16x17 mm
- 9 chaves macho hexagonal 1,5 - 2 - 2,5 - 3 - 4 - 5 - 6 - 8 - 10 mm
- 1 Chaves dinamométricas ZERO-RESET 3/8", 10+50 Nm
- 54 jogo com 52 pontas hexagonais, 10 mm, e 2 acessórios
- 17 jogo com 12 chaves de caixa e 5 acessórios
- 1 adaptador, chaves quadra 1/2" fêmea e 3/8" macho
- 2 chaves de caixa para velas 14 - 16 mm
- 1 alicate de pontas extra - longas 283 mm
- 2 alicates de freios interiores com pontas direitas 140 - 180 mm
- 1 alicates de freios exteriores com pontas direitas 140x1,3 mm
- 1 alicate de corte diagonal, punhos com duplo revestimento PVC, acabamento industrial 160 mm
- 1 tesoura de electricista 145 mm
- 1 alicate combinado para trabalhos pesados, punhos com duplo revestimento PVC, acabamento industrial 180 mm
- 1 chave para parafusos de perfil Dzus
- 4 chaves para parafusos de perfil de fenda 3x75 - 4x100 - 5,5x100 - 6,5x150 mm
- 3 chave para parafusos de perfil Phillips PH0x60 - PH1x80 - PH2x100 mm
- 1 busca - pólos
- 1 martelo para mecânico, tipo alemão 300 g
- 1 chaves para filtros de óleo com cinta metálica regulável
- 1 apalpa - folgas
- 1 mini serrote
- 1 Escova de fios de latão
- 1 almotolia plástica 250 cc

Refa. Nr.	
30	
32	
34	
42	
55	
96/C59	
666/5	
867/C52	
920A/C12X	
910/16	
956C	
1009L/A	
1032	
1036	
1082G	
1128BM	
1150G	
1201E/DZ	
1201E	
1202E	
1254	
1370	
1491	
1708/13	
1725CR	
1737	
1754	

€

5940SBK 1.420,00 059401082

Sortido recomendado para usar com os itens C41S - C41H - C42S - C42H - C42S - C41S





MC21



MC12



## 5941VU/M

Sortido de 64 ferramentas para carrinho C41, em tabuleiro maleável

### ► Utilização universal

#### Nr. Peças/Descrição

- 16 chaves mistas, boca-luneta 6-7-8-9-10-11-12-13-14-15-16-17-18-19-21-22 mm
- 9 chaves macho hexagonal  $\odot$  1,5-2-2,5-3-4-5-6-8-10 mm
- 1 fita métrica 5 m
- 19 chaves de caixa sextavadas, quadra de 1/2"
  - $\odot$  10-11-12-13-14-15-16-17-18-19-20-21-22-23-24-26-27-30-32 mm
- 1 cardan com quadras macho e fêmea de 1/2"
- 1 cabo T corrediço, quadra de 1/2"
- 1 roquete reversível, quadra de 1/2"  $\oplus$
- 2 extensões com quadras macho e fêmea - 1/2" 125-250 mm
- 1 Chave ajustável 250 mm
- 1 alicate de charneira fechada 250 mm
- 1 alicate de corte diagonal, punhos bi-material, acabamento industrial  $\nabla$  160 mm
- 1 tesoura de electricista 147 mm
- 1 alicate combinado para trabalhos pesados, punhos bi-material, acabamento industrial  $\equiv$  180 mm
- 1 alicate de pontas semi-redondas com estrias, extra-longas, punhos bi-material, acabamento industrial  $\bullet$  160 mm
- 3 chaves para parafusos de perfil de fenda  $\bullet$  3,5x100-5,5x125-6,5x150 mm
- 3 chaves para parafusos de perfil Phillips<sup>®</sup>  $\oplus$  PH0-PH1-PH2
- 1 martelo para mecânico, tipo alemão 300 g
- 1 x-acto com lâmina divisível de 18 mm 170 mm

Refa. Nr.	TR
42	MC12
96/SC9	MC12
1692/5	MC12
920A	MC21
920/25	MC21
920/42	MC21
920/55	MC21
920AN	MC21
111E	
1048N	
1082GBM	
1128BMX	
1150GBM	
1166GBM	
	1260
	1262
	1370
	1771

5941VU/M € 985,00 059411002

Sortido recomendado para usar com os itens C41





MM11



MM105



MM129



MM210



MM230

## 5945VUM

jogo 199 ferramentas em módulos soft EVA

### ► Utilização universal

Nr. Peças/Descrição

- 21 chaves mistas 6-7-8-9-10-11-12-13-14-15-16-17-18-19-20-21-22-24-27-30-32 mm
- 9 chaves macho sextavadas com uma extremidade esférica cromadas  $\odot$  1,5-2-2,5-3-4-5-6-8-10 mm
- 1 chave de caixa porta-pontas com encaixe quadra fêmea  $\odot$  1/4 -  $\square$  1/4
- 1 chave de caixa porta-pontas com encaixe quadra fêmea  $\odot$  1/4 -  $\square$  3/8
- 1 chave de caixa porta-pontas com encaixe quadra fêmea  $\odot$  5/16 -  $\square$  1/2
- 13 chaves de caixa sextavadas, quadra de 1/4"  $\odot$  4-4,5-5-5,5-6-7-8-9-10-11-12-13-14 mm
- 9 chaves de caixa série longa, boca sextavadas  $\odot$  5-6-7-8-9-10-11-12-13 mm
- 5 chaves de caixa com ponta sextavadas, quadra de 1/4"  $\odot$  3-4-5-6-7 mm
- 4 chaves de caixa com ponta de perfil de fenda  $\bullet$  0,8x4-1x5,5x1,2x6,5-1,2x8 mm
- 4 chaves de caixa com ponta de perfil Phillips®  $\oplus$  PH1-PH2-PH3-PH4
- 7 chaves de caixa com ponta macho de perfil Torx®  $\otimes$  T10-T15-T20-T25-T27-T30-T40
- 1 adaptador quadra fêmea de 1/4" para quadra macho de 3/8"  $\square$  1/4 -  $\blacksquare$  3/8
- 1 extensão, quadra 1/4" 50 mm
- 1 extensão, quadra 1/4" 100 mm
- 1 extensão, quadra 1/4" 150 mm
- 1 cardan com quadras macho e fêmea de 1/4"
- 1 extensão com punho, quadra macho de 1/4" 176 mm
- 1 cabo T correção, quadra de 1/4" 115 mm
- 1 roquete reversível, quadra de 1/4"  $\otimes$  125 mm
- 17 chaves de caixa, boca sextavadas 3/8"  $\odot$  6-7-8-9-10-11-12-13-14-15-16-17-18-19-20-21-22 mm
- 1 redução quadra fêmea de 3/8" para quadra macho de 1/4"  $\square$  3/8 -  $\blacksquare$  1/4
- 1 adaptador, chaves quadra 1/2" fêmea e 3/8" macho  $\square$  3/8 -  $\blacksquare$  1/2
- 1 extensões com quadras macho e fêmea - 3/8" 125 mm
- 1 extensões com quadras macho e fêmea - 3/8" 250
- 1 cardan com quadras macho e fêmea de 3/8"
- 1 cabo T correção, quadra de 3/8" 210 mm
- 1 roquete reversível, quadra de 3/8" 72 dentes  $\otimes$  200 mm
- 21 chaves de caixa sextavadas, quadra de 1/2"  $\odot$  8-10-11-12-13-14-15-16-17-18-19-20-21-22-23-24-26-27-28-30-32 mm
- 1 redução quadra fêmea de 1/2" para quadra macho de 3/8"  $\square$  1/2 -  $\blacksquare$  3/8
- 1 cardan com quadras macho e fêmea de 1/2"
- 1 extensões com quadras macho e fêmea - 1/2" 125 mm
- 1 extensões com quadras macho e fêmea - 1/2" 250 mm
- 1 cabo T correção, quadra de 1/2" 305 mm
- 1 roquete reversível, quadra de 1/2"  $\otimes$  275 mm
- 3 chaves de caixa 3/8" para velas  $\odot$  16 mm (5/8")-17,8 (11/16")-20,8 (13/16")
- 6 chaves para parafusos de perfil de fenda  $\bullet$  04x2,5x50-0,5x3x75-0,8x4x100-1,0x5,5x125-1,2x6,5x150-1,2x8x200 mm
- 1 chave para parafusos de perfil de fenda, série extra curta  $\bullet$  0,8x4x30 mm
- 4 chave para parafusos de perfil Phillips®  $\oplus$  PH0x60-PH1x80PH2x100PH3x150 mm
- 1 chave para parafusos de perfil Phillips®, série extra curta  $\oplus$  PH1x30 mm
- 12 chaves para parafusos de perfil Torx®, com punho  $\otimes$  T06-T07-T08-T09-T10-T15-T20-T25-T27-T30-T40-T45
- 1 busca - pólos  $\bullet$  0,5x3,5x100 mm
- 1 alicates de freios interiores com pontas direitas  $\odot$  180 mm
- 1 alicates de freios interiores com pontas curvas  $\odot$  170 mm
- 1 alicates de freios exteriores com pontas direitas  $\bullet$  175 mm
- 1 alicates de freios exteriores com pontas curvas  $\bullet$  175 mm
- 1 alicate de charneira fechada 250 mm
- 1 alicate de pressão 240 mm
- 1 alicate de pressão 240 mm
- 1 Alicates de corte diagonal  $\sphericalangle$  160 mm
- 1 turquês para cofragens 220 mm
- 1 tesoura de electricista 145 mm
- 1 alicate de pontas semi-redondas extra-longas  $\equiv$  180 mm
- 1 Alicates de pontas semi-redondas extralongas  $\bullet$  160 mm
- 3 punções  $\emptyset$  2-3-4 mm
- 6 saca-troços  $\emptyset$  2-3-4-5-6-8 mm
- 1 punção de bico  $\emptyset$  4 mm
- 1 escopros planos 150 mm
- 2 escopros planos 200-250 mm
- 1 buris 125 mm
- 1 martelo para mecânico, tipo alemão 500 g
- 1 martelo com batentes plásticos intermutáveis  $\emptyset$  35 mm
- 1 fita métrica 3 m
- 1 liman telescópico com cabeça flexível
- 1 limas quadradas meia-murças, com punho 200 mm
- 1 limas triangulares meia-murças, com punho 200 mm
- 1 limas chatas meia-murças, com punho 200 mm
- 1 limas meia-cana meia-murças, com punho 200 mm
- 1 limas redondas meia-murças, com punho 200 mm
- 1 Escova de fios de aço
- 1 x - acto com lâmina divisível de 18 mm 170 mm

Refa. Nr.	TR
42	MM11
96BPC/SC9	MM11
895/1	MM105
895/3	MM105
895/6	MM105
900	MM105
900L	MM105
900ME	MM105
900LP	MM105
900PH	MM105
900TX	MM105
900/16	MM105
900/20	MM105
900/20L	MM105
900/21	MM105
900/25	MM105
900BG/30	MM105
900/42	MM105
900/55	MM105
910A	MM105
910/15	MM105
910/16	MM105
910/21	MM105
910/22	MM105
910/25	MM105
910/42	MM105
910/55	MM105
920A	MM105
920/15	MM105
920/25	MM105
920AN	MM105
920AN	MM105
920/42	MM105
920/55	MM105
956E	MM105
1201E	MM210
1201EN	MM210
1202E	MM210
1202EN	MM210
1207E/TX	MM210
1253	MM210
1032	MM129
1034	MM129
1036	MM129
1038	MM129
1048N	MM129
1052	MM129
1052	MM129
1082BM	MM129
1098	MM129
1128BM	MM129
1150BM	MM129
1166BM	MM129
30	MM230
31	MM230
32	MM230
34	MM230
35	MM230
36	MM230
1370	MM230
1390	MM230
1692	MM230
1712TF	MM230
1719BMA...Q	MM230
1719BMA...T	MM230
1719BMA...P	MM230
1719BMA...M	MM230
1719BMA...R	MM230
1737NX	MM230
1771	MM230

5945VUM € 3.090,00 059451011

Ideal em combinação com o item C45





**5954VG**

jogo de 138 ferramentas

► **Reparação automóvel**

Nr. Peças/Descrição	Refa. Nr.
5 saca-troços Ø 2-3-4-5-6 mm	31
1 punção de bico Ø 4 mm	32
1 escopros planos 125 mm	34
18 chaves mistas, boca-luneta 6÷22 - 24 mm	42
8 chaves de bocas 6x7 - 8x9 - 10x11 - 12x13 - 14x15 - 16x17 - 18x19 - 20x22 mm	55
3 chaves de luneta curvatura profunda 12x13 - 14x15 - 17x19 mm	90
13 chaves macho hexagonal Ø 2÷10 - 12 mm	96
4 chaves de impacto hexagonal, quadra de 1/2" Ø 17 - 19 - 21 - 22 mm	720
20 chaves de caixa sextavadas, quadra de 1/2" Ø 10-11-12-13-14-15-16-17-18-19-20-21-22-23-24-26-27-28-30-32 mm	920A
1 extensão com quadras macho e fêmea de 1/2"	920/21
1 extensão com quadras macho e fêmea de 1/2"	920/22
1 cardan com quadras macho e fêmea de 1/2"	920/25
1 cabo T corrediço, quadra de 1/2"	920/42
1 roquete reversível, quadra de 1/2" Ⓞ	920/55
3 chave de caixa com punho, modelo longo Ø 8 - 10 - 13 mm	943BX
10 chaves de caixa hexagonais com cardan e cabo em T Ø 6 - 7 - 8 - 10 - 11 - 12 - 13 - 14 - 17 - 19 mm	952
3 chaves de caixa para velas Ø 16 - 17,8 - 20,8 mm	956C
1 alavanca com extremidades pontiaguda e em cunha	964
1 alicates de freios interiores com pontas direitas Ⓞ	1032
1 alicates de freios interiores com pontas curvas Ⓞ	1034
1 alicates de freios exteriores com pontas direitas ●	1036
1 alicates de freios exteriores com pontas curvas ●	1038
1 alicate de charneira fechada 250 mm	1048N
1 alicate de pressão 240 mm	1052
1 alicates de pressão bicos longos 175 mm	1058
1 Alicates de corte diagonal 160 mm	1082BM
1 tesoura de electricista 147 mm	1128BMX
1 alicate de pontas semi-redondas extra-longas ≡ 180 mm	1150BM
1 Alicates de pontas semi-redondas extralongas ● 160 mm	1166BM
1 busca - pólos ● 6÷24V	1254
1 chaves para parafusos de perfil de fenda ● 8 x 200 mm	1260
1 chave para parafusos de perfil de fenda série curta ● 6,5x30 mm	1260N
1 chaves para parafusos de perfil Phillips Ⓢ 8 x 150 mm	1262
1 chaves para parafusos de perfil Phillips® série curta Ⓢ PH2x30 mm	1262N
5 chaves para parafusos de perfil Torx® Ⓢ T8 - T10 - T15 - T20 - T25	1267TX
8 jogo de chaves de parafusos	1263/D8
1 martelo para mecânico, tipo alemão 300 g	1370
1 martelo anti - recuo com batentes plásticos intermutáveis Ø 35 mm	1392
1 alicate para as molas dos travões de tambor 210 mm	1470
1 alicate para cravar terminais não isolados	1603
1 fita métrica 5 m	1692
1 apalpa - folgas	1708/20
1 pesca-peças magnético 1,8 kg	1712E/2
6 jogo de 3 limas 160 mm	1720/B6
1 almotolia plástica 150 cc	1754

€

5954VG 2.630,00 059541054

Sortido recomendado em combinação com C54VG





## ► Reparação de motociclos

Nr. Peças/Descrição	Refa. Nr.
6 saca-troços Ø 2 - 3 - 4 - 5 - 6 - 8 mm	31/SP6
6 2 punções, 1 punção de bico e 3 escopros	38/SP6
17 chaves mistas, boca-luneta	42
6-7-8-10-11-12-13-14-15-16-17-19-21-22-24-27-30 mm	
12 chaves de bocas 6x7 + 30x32 mm	55/S12X
8 chaves de caixa sextavadas, quadra de 1/2" ○ 23+32 mm	96T/S8
1 chaves macho hexagonal 2 + 10 mm	96N/G7
8 ○ T9 + T40	97TX/SC8
5 chaves macho hexagonal com perfil XZN® ○ M5 + M12	98XZN/B5
1 Chave ajustável 250 mm	111E
1 Chaves dinâmicas ZERO-RESET ® 1/2", 40±200 Nm	666/20
13 chaves de caixa sextavadas, quadra de 1/2" ○ 10+22 mm	920A/SB13
8 chaves de caixa sextavadas, quadra de 1/2" ○ 23+32 mm	920A/SB8
4 chaves de caixa com ponta de fenda ● 1,2x6,5 - 1,2x8 - 1,6x9 - 2x12 mm	920LP
3 chaves de caixa com ponta de perfil Phillips® ● PH2 - 3 - 4	920PH
1 extensão com quadras macho e fêmea de 1/2" 125 mm	920/21
1 extensão com quadras macho e fêmea de 1/2" 255 mm	920/22
1 cardan com quadras macho e fêmea de 1/2"	920/25
1 cabo T corrediço, quadra de 1/2"	920/42
1 roquete reversível, quadra de 1/2" ®	920/55
2 chaves de impacto hexagonal, quadra de 1/2" ○ 17 - 19 mm	720
10 chaves de caixa hexagonais com cardan e cabo em T	952
○ 7 - 8 - 10 - 11 - 12 - 13 - 14 - 15 - 17 - 19 mm	
3 chaves em T para velas com cardan. série normal 14 - 16 - 20,8 mm	959
1 alavanca com extremidades chata e pontiaguda	963
1 chave em cruz para porcas de rodas ○ 1/2" - 17 - 19 - 22 mm	979
2 alicates de freios interiores com pontas direitas ○ 140 - 180 mm	1032
2 alicates de freios interiores com pontas curvas ○ 130 - 170 mm	1034
2 alicates de freios exteriores com pontas direitas ● 140x1,3 - 175 mm	1036
2 alicates de freios exteriores com pontas curvas ● 135x1,3 - 175 mm	1038
1 alicate de charneira fechada 250 mm	1048N
1 alicate de pressão 240 mm	1052
1 Alicates de corte diagonal 160 mm	1082BM
1 Alicates de corte diagonal para trabalhos pesados 160 mm	1084BM
1 alicate de corte frontal, articulado, serviço pesado, grande esforço 180 mm	1092V
1 tesoura modelo americano 250 mm	1112
1 tesoura de electricista 147 mm	1128BMX
1 alicate de pontas semi-redondas extra-longas = 180 mm	1150BM
1 Alicates de pontas semi-redondas extralongas ● 160 mm	1166BM
1 Alicates de pontas curvas semirredondas extralongas ● 200 mm	1168BM
2 chaves para parafusos de perfil de fenda ● 8x200 - 10x200 mm	1260
1 chaves para parafusos de perfil Phillips® ● PH3x150 mm	1262
8 jogo de chaves de parafusos	1263/D8
2 martelo para mecânico, tipo alemão 300 - 600 g	1370
1 martelo com batentes plásticos intermutáveis Ø 35 mm	1390
11 saca pernos com roletes M5+M16 mm	1433/C11
1 chaves para filtros de óleo com cinta metálica regulável	1491
1 verificador de tensão	1498
1 fita métrica 5 m	1692
1 apalpa - folgas	1708/20
1 pesca-peças magnético 1,8 kg	1712E/2
1 rascador curvo 200 mm	1717A
1 rascador triangular 200 mm	1717B
5 limas perfis diversos 200 mm	1719BMA8/S5
1 serrote com folha de serra bi-metálica	1725
1 almotolia metálica 200 cc	1751
1 x - acto com lâmina divisível de 18 mm 170 mm	1771BM
1 paquímetro	1650

€

5957VG

4.570,00 059571007

Sortido recomendado para usar com os itens C57S A - C57S B - C57SP- RSC50 PS - C55PS - C55PSE



# MÓDULOS TIPO SOFT (PARA FERRAMENTAS)



RSC23T  
RSC24  
RSC24A  
RSC24AXL  
RSC24AXLP/7  
RSC24AXXL  
RSC24L/7  
RSC24L-CAB  
RSC28  
C30M  
C37  
C37A  
C39  
C39T  
C39MD  
C39SM  
RSC51  
C57S  
C58BC  
C59  
RSC55  
RSC50 2.0

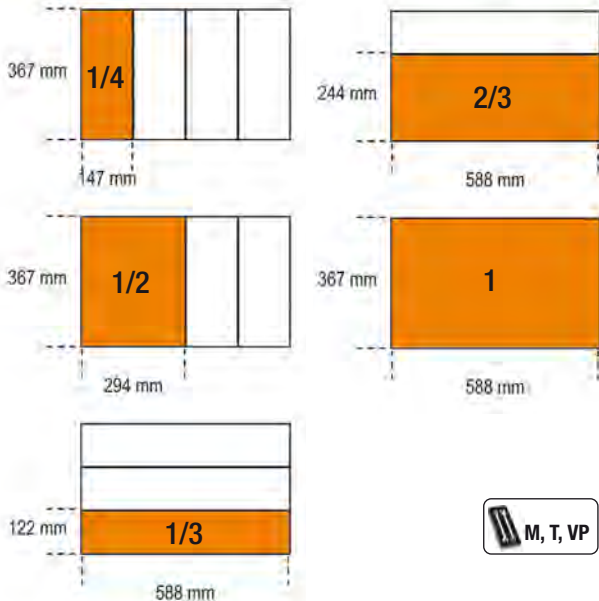

544÷554  
560÷568



## M01



42 6-7-8-9-10-11-12-13-14-15-16-17-18-19-20-21-22-24-27-30-32-36 mm

4,5 kg



M01	€ 493,00	1	024500001
MV10	75,50	1	024510010

## M02



42 6-7-8-9-10-11-12-13-14-15-16-17-18-19-20-21-22-23-24-25-26-27-28-29-30-32 mm

6,3 kg



M02	€ 550,00	1	024500002
MV02	75,50	1	024510002

## M05



42 6-7-8-9-10-11-12-13-14-15-16-17-18-19-20-21 mm

1,5 kg



M05	€ 239,00	1	024500005
MV15	39,50	1	024510015

## M06



42 22-24-27-30-32 mm

2,1 kg



M06	€ 170,00	1	024500006
MV16	53,50	1	024510016

## M13



42SLIM 8-10-11-12-13-14-15-16-17-18-19 mm

1,2 kg



M13	€ 178,00	1	024500013
MV13	39,50	1	024510013

## M25



42 6-7-8-9-10-11-12-13-14-15-16-17-18-19-21-22-24-27 mm  
90 6x7-8x9-10x11-12x13-14x15-16x17-18x19 mm  
123Q1/4  
123Q3/8  
123Q1/2  
142 8-9-10-11-12-13-14-15-16-17-18-19 mm

5,1 kg



M25	€ 785,00	1	024500025
MV25	75,50	1	024510873

## M30



55 6x7-8x9-10x11-12x13-14x15-16x17-18x19-20x22-21x23-24x27-30x32 mm  
90 6x7-8x9-10x11-12x13-14x15-16x17-18x19-20x22-21x23-24x27-30x32 mm  
96BPC/SC9 1,5-2-2,5-3-4-5-6-8-10 mm

4,2 kg



M30	€ 459,00	1	024500030
MV30	75,50	1	024510030





# Beta

## M32

27



**42AS** 1/4 - 9/32 - 5/16 - 3/8 - 7/16 - 1/2 - 9/16  
- 19/32 - 5/8 - 11/16 - 3/4 - 13/16 - 7/8 -  
15/16 - 1 - 1.1/16 - 1.1/8 - 1.1/4  
**96BP/AS-SC9** 1/16 - 3/32 - 1/8 - 5/32 - 3/16 - 7/32 - 1/4  
- 5/16 - 3/8

4,5 kg

<b>M32</b>	€ 480,00	1	024500032
<b>MV31</b>	€ 75,50	1	024510031

## M33

17



**55** 6x7-8x9-10x11  
12x13-14x15  
16x17-18x19  
20x22 mm  
**96/SC9** 1,5+10 mm

1,1 kg

<b>M33</b>	€ 110,00	1	024500033
<b>MV33</b>	€ 39,50	1	024510033

## M38

4



**55** 21x23-24x26  
27x29-30x32 mm

1,7 kg

<b>M38</b>	€ 92,50	1	024500038
<b>MV38</b>	€ 53,50	1	024510038

## M40

7



**90** 6x7-8x9-10x11  
12x13-14x15  
16x17-18x19 mm

810 g

<b>M40</b>	€ 122,00	1	024500040
<b>MV40</b>	€ 39,50	1	024510040

## M44

12



**141** 8-9-10-11-12  
13-14-15-16  
17-18-19 mm

1,3 kg

<b>M44</b>	€ 313,00	1	024500044
<b>MV44</b>	€ 39,50	1	024510044



# Beta



## M45

12



**142** 8-9-10-11-12  
13-14-15-16  
17-18-19 mm

1,3 kg

<b>M45</b>	€ 352,00	1	024500045
<b>MV45</b>	€ 39,50	1	024510045

## M46

12



**142SN** 8-9-10-11-12  
13-14-15-16  
17-18-19 mm

1,4 kg

<b>M46</b>	€ 415,00	1	024500046
<b>MV46</b>	€ 39,50	1	024510046

## M49

24



**52MQ** 7 - 8 - 10 - 11 - 12 - 13 - 14 - 15 - 16 - 17  
- 19 - 22 mm  
**89MQ** 7 - 8 - 10 - 11 - 12 - 13 - 14 - 15 - 16 - 17  
- 19 - 22 mm

3,3 kg

<b>M49</b>	€ 1.260,00	1	024500049
<b>MV49</b>	€ 75,50	1	024510049

## M50

8



**96T** 2-2,5-3-4-5  
6-7-8 mm

1,1 kg

<b>M50</b>	€ 143,00	1	024500050
<b>MV50</b>	€ 53,50	1	024510051



## M52

5



96T 2,5-3-4-5-6 mm

330 g



M52	84,50	1	024500052
MV52	39,50	1	024510052

## M53

5



96TBP 2,5-3-4-5-6 mm

350 g



M53	89,50	1	024500053
MV52	39,50	1	024510052

## M55

5



97TTX T10-T15-T20-T25-T30

330 g



M55	93,50	1	024500055
MV55	39,50	1	024510055



## M60

23



- 96T 2 - 2,5 - 3 - 4 - 5 - 6 - 7 - 8 - 10 mm
- 97BTX/SC8 T9 - T10 - T15 - T20 - T25 - T27 - T30 - T40
- 944BX 5-6-7-8-10-13 mm

1,9 Kg



M60	422,00	1	024500060
MV60	75,50	1	024510060

## M62

21

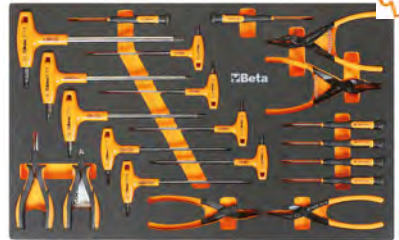

- 97TTX T10 - T15 - T20 - T25 - T27 - T30 - T40 - T45 - T50
- 1032 180 mm
- 1034 170 mm
- 1036 175 mm
- 1038 175 mm
- 1177BM 140 mm
- 1188BM 125 mm
- 1257LP 2-2,5-3-3,5 mm
- 1257PH 0-00

2,3 kg



M62	505,00	1	024500875
MV62	75,50	1	024510875

## M63

8



952 7 - 8 - 10 - 12 - 13 - 14 - 17 - 19 mm

3,4 kg



M63	383,00	1	024500063
MV63	75,50	1	024510063

## M65

16

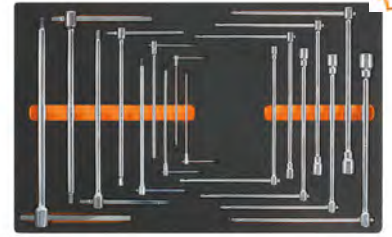

950 8 - 10 - 12 - 13 - 14 - 17 - 19 mm  
951 2,5 - 3 - 4 - 5 - 6 - 8 - 10 - 12 - 14 mm

3,6 Kg



M65	580,00	1	024500065
MV65	75,50	1	024510065

## M67

6

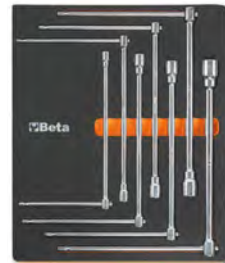

950 7-8-10-12-13-17 mm

1,8 kg



M67	223,00	1	024500067
MV67	53,50	1	024510067

## M69

9

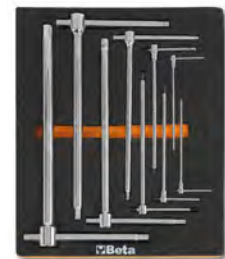

951 2,5-3-4-5-6-8 10-12-14 mm

1,8 kg



M69	329,00	1	024500069
MV69	53,50	1	024510069



## M75

16



933 7-8-9-10-11-12-13-14-15  
16-17-18-19-21-22-24 mm

5,5 kg



M75	€ 491,00	1	024500075
MV75	€ 75,50	1	024510075

## M78

17



80 6x7 - 8x9 - 10x11 - 12x13 - 14x15 - 16x17 - 18x19 mm

920/36A  
965 450 mm  
1052 240 mm  
1058 175 mm  
1481PL/A  
1481PL/B  
1481PL/C  
1650 150 mm  
1708/20  
1716P

4,4 kg



M78	€ 760,00	1	024500878
MV77	€ 75,50	1	024510876

## M82

29



920A 10-11-12-13-14  
15-16-17-18-19  
20-21-22-23-24  
26-27-30-32 mm  
920ME 5-6-8-10-12 mm  
920AN/125 125 mm  
920AN/250 250 mm  
920/25  
920/42 305 mm  
920/55

4,1 kg

12"



M82	€ 483,00	1	024500082
MV84	€ 53,50	1	024510084



## M83

24



920A 10-11-12-13-14  
15-16-17-18-19  
20-21-22-23-24  
26-27-30-32 mm  
920AN/125 125 mm  
920AN/250 250 mm  
920/25 255 mm  
920/42 305 mm  
920/55

3,7 kg

12"



M83	€ 390,00	1	024500083
MV87	€ 53,50	1	024510087

## M85

45



851SR 230 mm  
860LP 0,5x3 - 0,6x4,5 -  
0,8x5,5 - 1x5,5 -  
1,2x6,5 mm  
860PE 2 - 2,5 - 3 - 4 - 5 - 6 - 8 -  
10 mm  
860PH PH0 - PH1 - PH2 -  
PH3 - PH4  
860PZ PZ1 - PZ2 - PZ3 - PZ4  
860TX T6 - T7 - T8 - T9 - T10 -  
T15 - T20 - T25 - T27 -  
T30 - T40  
860RTX T9 - T10 - T15 - T20 -  
T25 - T27 - T30 - T40  
860/55 100 mm  
882P 80 mm  
892 1/4 - 1/4

450 g

1/4"



M85	€ 221,00	1	024500085
MV85	€ 39,50	1	024510085

## M86

46



867PE 4-5-6-7-8-10-12 mm  
867PE/L 4-5-6-7-8-10-12 mm  
867XZN 5-6-8-10-12 mm  
867XZN/L 5-6-8-10-12 mm  
867TX T20 - T25 - T30 - T40 -  
T45 - T50 - T55  
867TX/L T25 - T30 - T40 - T45 -  
T50 - T55  
867RTX T20 - T25 - T30 - T40 -  
T45 - T50 - T55  
867/1  
867/2

1,4 kg

10"



M86	€ 159,00	1	024500086
MV86	€ 39,50	1	024510086

## M91

25



900 4 - 4,5 - 5 - 5,5 - 6 - 7 -  
8 - 9 - 10 - 11 - 12 -  
13 - 14 mm  
900ME 2,5-3-4-5-6-8 mm  
900/20 50 mm  
900/21 150 mm  
900/25 □ 1/4 - ■ 1/4  
900BG/30  
900/42  
900/55

560 g

14"



M91	€ 262,00	1	024500091
MV89	€ 39,50	1	024510089

## M92

22



910A 6-7-8-9-10-11-12-13-  
14-15-16-17-18-19-20-  
21-22 mm  
910/21 125 mm  
910/22 250 mm  
910/25  
910/42  
910/55

1,5 kg

3/8"



M92	€ 295,00	1	024500092
MV93	€ 39,50	1	024510093

## M94

26



900AS/L 3/16 - 7/32 - 1/4 - 9/32 -  
5/16 - 11/32 - 3/8 -  
7/16 - 1/2 - 9/16  
900AS 3/16 - 7/32 - 5/32 - 1/4 -  
9/32 - 5/16 - 11/32 -  
3/8 - 7/16 - 1/2 - 9/16  
900AN 50-100mm  
900/25  
900/55  
900/42

930 g

14"



M94	€ 303,00	1	024500094
MV95	€ 39,50	1	024510095

## M96

22



920A/AS 3/8 - 7/16 - 1/2 - 9/16 -  
19/32 - 5/8 - 11/16 -  
3/4 - 25/32 - 13/16 -  
7/8 - 15/16 - 1 - 1.1/16 -  
1.1/18 - 1.3/16 -  
1.1/4  
920/25  
920AN 125-250mm  
920/42  
920/55

3,8 kg

12"



M96	€ 401,00	1	024500096
MV97	€ 53,50	1	024510097



# M100

98

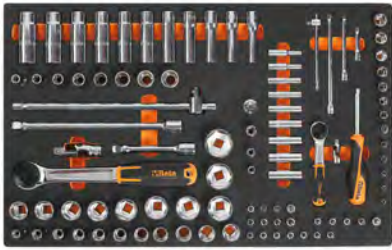

- 895/1
- 895/3
- 895/6
- 900 4-4,5-5-5,5-6-7-8-9-10-11-12-13-14 mm
- 900L 5-6-7-8-9-10-11-12-13 mm
- 900ME 3-4-5-6-7 mm
- 900LP 0,8x4 - 1x5,5 - 1,2x6,5 - 1,2x8 mm
- ⊕ 900PH PH1-PH2-PH3-PH4
- ⊗ 900TX T10 - T15 - T20 - T25 - T27 - T30 - T40
- 900/20 50 mm
- 900/20L 100 mm
- 900/21 150 mm
- 900/25
- 900BG/30
- 900/42
- ⊗ 900/55
- 920A 8-10-11-12-13-14-15-16-17-18-19-20-21-22-23-24-26-27-28-30-32 mm
- 920/15
- 920/25
- 920AN/125 125 mm
- 920AN/250 250 mm
- 920/42
- ⊗ 920/55
- 920FTX 10-12-14-16-18-20-22-24 mm
- 920AL 10-12-13-14-15-16-17-18-19-21-22

6,7 kg

14" 12"

M100	1.350,00	1 024500100
MV104	75,50	1 024510104

# M105

116



- 900 4-4,5-5-5,5-6-7-8-9-10-11-12-13-14 mm
- 900L 5-6-7-8-9-10-11-12-13 mm
- 96BPC/SC9 1,5-2-2,5-3-4-5-6-8-10 mm
- 895/1
- 895/3
- 895/6
- 900ME 3-4-5-6-7 mm
- 900LP 0,8x4 - 1x5,5 - 1,2x6,5 - 1,2x8 mm
- ⊕ 900PH PH1-PH2-PH3-PH4
- ⊗ 900TX T10 - T15 - T20 - T25 - T27 - T30 - T40
- 900/16 □ 1/4 - ■ 3/8
- 900/... 50-100-150 mm
- 900/25
- 900BG/30
- 900/42
- ⊗ 900/55
- 910A 6-7-8-9-10-11-12-13-14-15-16-17-18-19-20-21-22 mm
- 910/15 □ 3/8 - ■ 1/4
- 910/16 □ 3/8 - ■ 1/2
- 910/21 125 mm
- 910/22 250 mm
- 910/25
- 910/42
- ⊗ 910/55
- 920A 8-10-11-12-13-14-15-16-17-18-19-20-21-22-23-24-26-27-28-30-32 mm
- 1/2 - ■ 3/8
- 920/15
- 920/25
- 920AN 125-250 mm
- 920/42
- ⊗ 920/55
- 956E 16-17,8-20,8 mm

7,7 kg

14" 3/8" 12"

M105	1.460,00	1 024500871
MV107	75,50	1 024510107

# M108

27



- 910MQ/PE 4-5-6-8 mm
- 910MQ/B 7-8-10-11-12-13-14-15-16-17-19 mm
- ⊗ 910MQ/TX T15 - T20 - T25 - T27 - T30 - T40
- 910MQ/XZN 8-10 mm
- 910MQ/21 140 mm
- 910MQ/22 265 mm
- 910MQ/T
- 910MQ/55

2,7 kg

M108	1.380,00	1 024500108
MV108	75,50	1 024510108

# M110

36



- ⊗ 850MQ
- ⊗ 861TX/A10
- 920MQ/A 8-9-10-11-12-13-14-15-16-17-18-19-20 mm
- 920MQ/PE 5-6-8-10-12 mm
- 920MQ/21 125 mm
- 920MQ/22 250 mm
- 920MQ/55A
- 943MQ 6-7-8-10 mm

3,1 kg

M110	1.380,00	1 024500110
MV110	75,50	1 024510110

# M112

32



- ⊗ 861TX ● 1/4-T6+T15
- ⊗ 866TX ● 5/16-T20+T55
- 895/1 ○ 1/4x□1/4
- 895/6 ○ 5/16x□1/2
- ⊗ 900FTX □ 1/4-E4+E10
- ⊗ 920FTX □ 1/2-E12+E24
- ⊗ 920TX □ 1/2-T55L-T60-T70L

1,3 kg

14" 12"

M112	342,00	1 024500112
MV112	39,50	1 024510112

# M115

54



- ⊗ 666/20 40+200 Nm
- 920A 13-14-15-16-17-18-19-20-21-22-24-26-27-30-32 mm
- ⊗ 920FTX 12-14-16-18-20-22-24 mm
- 920PE 6-7-8-8L-10-10L-12-12L-14-14L
- ⊗ 920TX T20 - T25 - T27 - T30 - T40 - T45 - T50 - T55 - T60 - T20L - T25L - T27L - T30L - T40L - T45L - T50L
- 920/21 125 mm
- 920/22 255 mm
- 920/25
- 920/42 305 mm
- ⊗ 920/55

7,8 kg

12"

M115	1.280,00	1 024500115
MV117	75,50	1 024510117

# Beta



## M118

33



- 1927P
- 720L 13-17-19-21-22-24 mm
- 720ME 5-6-8-10-12-14-17-19 mm
- 720 10-12-13-14-15-16-17  
18-19-21-22-24-27-30-32 mm
- 720LC 17-19-21 mm

1,8 g



M118	1.090,00	1	024500118
MV118	75,50	1	024510118

ADEQUADO PARA GAVETAS DE 140 MM

## M120

75



- 920A 10-11-12-13-14-15-16-17-18-19-20-21  
22-24-26-27-30-32 mm
- 920AN/125 125 mm
- 920AN/250 250 mm
- 920/25
- 920/42
- 920AL 10 - 12 - 13 - 14 - 15 - 16 - 17 - 18 - 19 -  
22 - 24 - 27 - 30 - 32 mm
- 920FTX 10 - 12 - 14 - 16 - 18 - 20 - 22 - 24 mm
- 920/55
- 920PE 5 - 5L - 6 - 6L - 7 - 7L - 8 - 8L - 10 - 10L  
- 12 - 12L - 14 - 14L
- 920TX T20-T25-T27-T30-T40-T45-T50-T55-T60  
T20L-T25L-T27L-T30L-T40L-T45L-T50L

6,9 Kg

12"



M120	1.430,00	1	024500120
MV119	75,50	1	024510119

## M121

46



- 920BP 5L - 6L - 8L - 10L - 5XL - 6XL - 8XL mm
- 920TX T20 - T25 - T27 - T30 - T40L - T45L  
- T50L - T55L - T60L - T70L
- 920XZN 4 - 5 - 6 - 6L - 8 - 8L - 10 - 10L - 12 - 12L  
- 14 - 14L - 16 - 18 mm
- 920ES 7 - 9 - 10 - 11 - 12L - 14L - 16L - 7XL -  
9XL - 10XL - 11XL - 12XL - 14XL - 16XL  
mm

920/36A

6,3 Kg

12"



M121	1.330,00	1	024500121
MV121	75,50	1	024510121

## M125

68



- 910AL 8 - 9 - 10 - 11 - 12 - 13 - 14 - 15 - 16 - 17  
- 19 - 21 - 22 mm
- 920PE 5-6-6L-7-8-8L-10-10L-12-12L mm
- 920FTX E12 - E14 - E16 - E18 - E20 - E22 - E24
- 920TX T20 - T25 - T27 - T30 - T30L - T40 - T40L  
- T45 - T50 - T50L - T55 - T60 - T60L
- 920XZN 5 - 6 - 6L - 8 - 8L - 10 - 10L - 12L mm
- 920AL 10 - 12 - 13 - 14 - 15 - 16 - 17 - 18 - 19  
- 21 - 22 - 23 - 24 - 27 - 30 - 32 mm

1692/5

7,9 kg

38" 12"



M125	1.380,00	1	024500872
MV125	75,50	1	024510872

## M126

26



- 928A 19 - 21 - 22 - 24 - 26 - 27 - 28 - 30 - 32  
- 34 - 35 - 36 - 38 - 41 - 46 mm
- 928ME 14-17-19-22 mm
- 928/15 □ 3/4 - ■ 1/2
- 928/16 □ 3/4 - ■ 1
- 928/21 200 mm
- 928/22 380 mm
- 928/25
- 928/42 450 mm
- 928/55

12,4 kg

34"



M126	1.060,00	1	024500126
MV139	75,50	1	024510139

## M127

23



- 728 19 - 21 - 22 - 24 - 27 - 30 - 32 - 33 - 34  
- 35 - 36 - 38 - 40 - 41 - 46
- 728FTX 20-22-24 mm
- 728/15 □ 3/4 - ■ 1/2
- 728/16 □ 3/4 - ■ 1
- 728/21 175 mm
- 728/22 250 mm

12,5 kg

34"



M127	1.010,00	1	024500127
MV127	75,50	1	024510127

## M128

50



- 720 10 - 11 - 12 - 13 - 14 - 15 - 16 - 17 - 18  
- 19 - 21 - 22 - 24 - 27 - 30 - 32 mm
- 720L 10 - 11 - 12 - 13 - 14 - 15 - 16 - 17 - 18  
- 19 - 21 - 22 - 24 - 27 - 30 - 32 mm
- 720TX T30-T40-T45-T50-T55
- 720ME 5 - 6 - 8 - 10 - 12 - 14 - 17 - 19 mm
- 720LC 17-19-21 mm

8,9 kg

12"



M128	1.050,00	1	024500128
MV128	75,50	1	024510128

## M129

13



- 1032 180 mm
- 1034 170 mm
- 1036 175 mm
- 1038 175 mm
- 1048N 250 mm
- 1052 240 mm
- 1082BM 160 mm
- 1098 220 mm
- 1112 250 mm
- 1128BM 145 mm
- 1150BM 180 mm
- 1166BM 160 mm
- 1168BM 160 mm

3,4 Kg



M129	490,00	1	024500129
MV138	75,50	1	024510138

## M133

3



- 1082G 160 mm
- 1150G 180 mm
- 1166G 160 mm

650 g



M133	94,50	1	024500133
MV133	39,50	1	024510133

## M134

3



- 1082GBM 160 mm
- 1150GBM 180 mm
- 1166GBM 160 mm

750 g



M134	120,00	1	024500134
MV134	39,50	1	024510134

## M135

3



- 1082MQ 160 mm
- 1150MQ 180 mm
- 1166MQ 160 mm

750 g



M135	198,00	1	024500135
MV135	39,50	1	024510135

## M136

3



- 1084BM 160 mm
- 1150BM 180 mm
- 1166BM 160 mm

750 g



M136	135,00	1	024500136
MV131	39,50	1	024510131

## M137

3



- 1084 160 mm
- 1150 180 mm
- 1166 160 mm

650 g



M137	110,00	1	024500137
MV132	39,50	1	024510132

## M145

4



- 1032 180 mm
- 1034 170 mm
- 1036 175 mm
- 1038 175 mm

640 g



M145	148,00	1	024500145
MV145	39,50	1	024510145

## M153

2



- 1048N 250 mm
- 1052 240 mm

1 kg



M153	113,00	1	024500153
MV154	39,50	1	024510154

## M161

15



- 1128MQ 145 mm
- 1048MQ 250 mm
- 1082MQ 160 mm
- 1150MQ 180 mm
- 1162MQ 160 mm
- 1164MQ 160 mm
- 1272MQ PH0x60 - PH1x80 - PH2x100 - PH3x150 mm
- 1274MQ 2,5x75 - 3x100 - 4x100 - 5,5x125 mm
- 1777MQ/U

3,0 kg



M161	585,00	1	024500161
MV161	75,50	1	024510161



## M162

8



- 1241 5,5x100 - 6,5x125 - 8x150 - 10x200 mm
- 1242 PH1x100 - PH2x100 - PH3x150 - PH4x200 mm

1,4 kg



M162	165,00	1	024500162
MV162	53,50	1	024510162

## M166

49



861MIX/A31

- 1048N 250 mm
- 1082BM 160 mm
- 1150BM 180 mm
- 1162BM 160 mm
- 1290 3x75 - 4x100 - 5,5x100 - 6,5x150 - 8x150 mm
- 1290N 6,5x30 mm
- 1292 4,5x80 - 6x100 - 8x150 mm
- 1292N 6x30 mm
- 1297TX T20-T25-T27-T30

2,9 kg



M166	505,00	1	024500879
MV880	75,50	1	024510880

## M170

7



- 1290 2,5x50 - 3x75 - 3,5x100 - 4x125 - 5,5x100 - 5,5x150 - 6,5x150 mm

500 g



M170	88,50	1	024500170
MV170	39,50	1	024510170





## M172

6



- 1292 PH0x60  
PH0x100  
PH1x80  
PH1x120  
PH2x100  
PH2x150 mm

450 g



M172	€ 80,00	1	024500172
MV172	€ 39,50	1	024510172

## M174

6



- 1297TX T8 - T10 - T15 - T20 - T25 - T30

450 g



M174	€ 118,00	1	024500174
MV174	€ 39,50	1	024510174

## M180

7



- 1290 3x75  
4x100  
5,5x150  
6,5x150 mm
- 1292 PH0x60  
PH1x80  
PH2x100 mm

500 g



M180	€ 91,50	1	024500180
MV180	€ 39,50	1	024510180



## M195

25



- 1260 2,5x50 - 3x75 - 4x100 - 5,5x125 - 6,5x150 - 8x200 mm
- 1260N 4x30 mm
- 1262 PH0x60 - PH1x80 - PH2x100 - PH3x150 mm
- 1262N PH1X30 mm
- 1267TX T6 - T7 - T8 - T9 - T10 - T15 - T20 - T25 - T27 - T30 - T40 - T45
- 1253 3,5x100 mm

2,3 kg



M195	€ 360,00	1	024500195
MV195	€ 75,50	1	024510195

## M201

6



- 1260 3x75 - 4x100 - 6,5x150 mm
- 1262 PH0x60 - PH1x80 - PH2x100 mm

500 g



M201	€ 91,00	1	024500201
MV201	€ 39,50	1	024510201

## M204

6



- 1267TX T8 - T10 - T15 - T20 - T25 - T30

450 g



M204	€ 89,50	1	024500204
MV204	€ 39,50	1	024510204

## M208

10



- 1260 3x75  
3,5x100  
4x125  
5,5x150  
6,5x150 mm
- 1262 PH0x60  
PH1x80  
PH2x100 mm
- 1260N 4x30 mm
- 1262N PH1x30 mm

750 g



M208	€ 103,00	1	024500208
MV208	€ 53,50	1	024510208

## M209

10



- 1260N 4x30 mm
- 1264 2,5x60 - 3x100 - 4x125 - 5x150 - 6,5x150 mm
- 1262 PH0x60 - PH1x80 - PH2x100 mm
- 1262N PH1x30 mm

820 g



M209	€ 101,00	1	024500209
MV208	€ 53,50	1	024510208

## M213

25



- 1201E 2,5x50 - 3x75 - 4x100 - 5,5x125 - 6,5x150 - 8x200 mm
- 1201EN 4x30 mm
- 1202E PH0x60 - PH1x80 - PH2x100 - PH3x150 mm
- 1202EN PH1X30 mm
- 1207E/TX T6 - T7 - T8 - T9 - T10 - T15 - T20 - T25 - T27 - T30 - T40 - T45
- 1253 3,5x100 mm

1,8 Kg



M213	€ 243,00	1	024500213
MV210	€ 75,50	1	024510210





## M214



- 1201E 2,5x50 - 3x75 - 3,5x100 - 4x125 - 5,5x100 - 5,5x150 - 6,5x150 mm

500 g



M214	49,50	1	024500214
MV211	39,50	1	024510211

## M216



- 1202E PH0x60 - PH1x80 - PH1x120 - PH2x100 - PH2x150 - PH3x150 mm

450 g



M216	54,00	1	024500216
MV212	39,50	1	024510212

## M217



- 1207E/TX T6 - T7 - T8 - T9 - T10 - T15 - T20

500 g



M217	69,00	1	024500217
MV215	39,50	1	024510215

## M218



- 1201E 3x75 - 4x100 - 5,5x150 - 6,5x150 mm
- 1202E PH0x60 - PH1x80 - PH2x100 mm

500 g



M218	52,50	1	024500218
MV220	39,50	1	024510220

## M222



- 1272MQ PH0x60 mm
- 1272MQF PH1x80 - PH2x100 mm
- 1274MQF 3,5x100 - 4,5x100 - 5,5x125 - 6,5x150 mm

540 g



M222	150,00	1	024500222
MV222	39,50	1	024510222

## M226



- 1274MQ 3x100 - 4x100 - 5,5x125 - 6,5x150 mm
- 1272MQ PH0x60 - PH1x80 - PH2x100 mm

500 g



M226	114,00	1	024500226
MV226	39,50	1	024510226

## M227



- 944BX 6-7-8-10-13 mm

420 g



M227	140,00	1	024500227
MV227	39,50	1	024510227

## M230



- 30 Ø 2-3-4 mm
- 31 Ø 2-3-4-5-6-8 mm
- 32 Ø 4 mm
- 34 150 mm
- 35 200-250 mm
- 36 125 mm
- 1370 500 g
- 1390 Ø 35 mm
- 1692 3 m
- 1712TF
- 1719BMA/Q 200 mm
- 1719BMA/T 200 mm
- 1719BMA/P 200 mm
- 1719BMA/M 200 mm
- 1719BMA/R 200 mm
- 1737NX
- 1771 170 mm

3,2 kg



M230	464,00	1	024500230
MV230	75,50	1	024510230

## M231



- 31 2-3-4-5-6-8 mm
- 32 4 mm
- 34 125-150-175 mm
- 36 125 mm
- 1370 500-1000 g
- 1390 Ø 35 mm
- 1712TF 590 mm
- 1715 670 mm
- 1719BMA8/Q 200 mm
- 1719BMA8/T 200 mm
- 1719BMA8/P 200 mm
- 1719BMA8/M 200 mm
- 1719BMA8/R 200 mm
- 1737NX

4,7 kg



M231	441,00	1	024500877
MV231	75,50	1	024510877



## M234



35 100-200 mm  
1370 300 g  
1390 Ø 35 mm

1,3 kg



M234	€ 115,00	1	024500234
MV232	€ 39,50	1	024510232

## M236



- 1719BMA/Q 200 mm
- ▲ 1719BMA/T 200 mm
- 1719BMA/P 200 mm
- ▶ 1719BMA/M 200 mm
- 1719BMA/R 200 mm

870 g



M236	€ 114,00	1	024500236
MV236	€ 39,50	1	024510236

## M237



35 100-200 mm  
1370T 300 mm  
1390N Ø 35 mm

1,3 kg



M237	€ 126,00	1	024500237
MV232	€ 39,50	1	024510232

## M240



31BM Ø 2-3-4-5-6-8 mm  
32 Ø 4 mm

850 g



M240	€ 150,00	1	024500240
MV240	€ 39,50	1	024510240



## M264



- 1491 Ø 65+110 mm
- 1494 ■ 10 mm
- 1494E ○ 8 - 9 - 10 - 11 - 12 - 14 - 17 mm
- 1494Q ○ 8-9,5-12-13 mm
- △ 1494T △ 9,5
- 1494XZN ○ 16
- 1496C ■ 8x ■ 10 mm

2,1 kg



M264	€ 266,00	1	024500264
MV264	€ 39,50	1	024510264

## M284



- 1128BMX 147 mm
- 1130BMX 185 mm
- 1719BMA...Q 200 mm
- ▲ 1719BMA...T 200 mm
- 1719BMA...P 200 mm
- ▶ 1719BMA...M 200 mm
- 1719BMA...R 200 mm
- 1726BM 400 mm
- 1728BM (5)
- 1771BM 170 mm
- 1778V18 185 mm

2,4 Kg



M284	€ 269,00	1	024500284
MV284	€ 75,50	1	024510284

## M292



- 111E 250 mm
- 1128BMX 147 mm
- 1692/5 5 m
- 1771 170 mm

500 g



M292	€ 129,00	1	024500292
MV293	€ 39,50	1	024510293

## M294



1692/5 5 m  
1725CR 260 mm  
1771 170 mm  
1771RL

500 g



M294	€ 88,00	1	024500294
MV294	€ 39,50	1	024510294

## M295



1650  
1682 300 mm  
1707  
1708/20

450 g



M295	€ 130,00	1	024500295
MV295	€ 39,50	1	024510295





### M400

29



- 3932U
- 3935 120 mm
- 3937 170 mm
- 3952 13 - 14 - 15 - 16 - 17 - 18 - 19 mm
- 3961 3,2
- 3961 3,3
- 3961 3,5
- 3961U 3,2 - 4,0 mm
- 3969 200 mm (x2)
- 3969K3 113 mm
- 3973/1
- 3973/2
- 3973/3
- 3973/4
- 3984/1 Ø35 mm
- 3984/2 Ø22,8 mm
- 3984/3 Ø23,5 mm
- 3984/4 Ø23 mm
- 3991 222 mm
- 3992 234 mm

3,1 kg



M400	€ 680,00	1	024500400
MV400	75,50	1	024510400

### M401

7



- 3921 440 mm
- 3948
- 3953
- 3955 30x32 - 32x36 mm
- 3967 289 mm
- 3971

2,7 kg



M401	€ 411,00	1	024500401
MV401	75,50	1	024510401

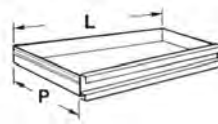

RSC22  
RSC23  
RSC23C  
C27S

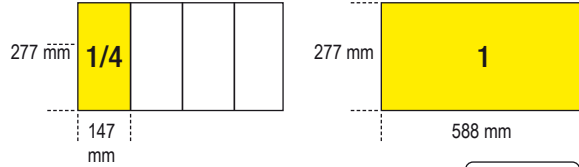

554  
569

C41S  
C41H

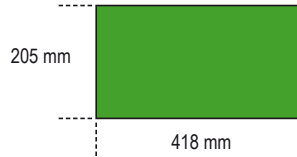

554

### MC10

34



- 42 6-7-8-9-10-11-12  
13-14-15-16-17  
18-19-21-22 mm
- 96/SC9 1,5 - 2 - 2,5 - 3 - 4 - 5 - 6 - 8 - 10 mm
- ⌘ 1084BM 160 mm
- ≡ 1150G 180 mm
- 1166G 160 mm
- 1201E 3,5x100 - 5,5x150 - 6,5x150 mm
- ⊕ 1202E PH0x60 - PH1x80 - PH2x100 mm

3,5 kg



MC10	€ 432,00	1	027500011
MCV10	64,50	1	027510010

### MC12

26



- 42 6 - 7 - 8 - 9 - 10 - 11 - 12 - 13 - 14 - 15 - 16 - 17  
18 - 19 - 21 - 22 mm
- 96/SC9 1,5 - 2 - 2,5 - 3 - 4 - 5 - 6 - 8 - 10 mm
- 1692/5 5 m

2,2 kg



MC12	€ 285,00	1	041500012
MCV11	64,50	1	041510011

### MC20

74



- 861MIX/A31
- 895/1
- 1048N 250 mm
- 1370 300 g
- 32 Ø 4 mm
- 36 Ø 4 mm
- 900 4 - 4,5 - 5 - 5,5 - 6 - 7 - 8 - 9 - 10 - 11 - 12 - 13 - 14 mm
- 900/21 150 mm
- 900/25
- 900BG/30C
- 900/42
- 900/55
- 920A 10 - 11 - 12 - 13 - 14 - 15 - 16 - 17 - 18 - 19 - 21 - 22 - 24  
- 27 - 30 - 32 mm

920/25

920AN/125 125 mm

920/42

920/55

6 kg



MC20	€ 675,00	1	027500020
MCV24	64,50	1	027510024

### MC21

24



- 920A 10 - 11 - 12 - 13 - 14 - 15 - 16 - 17 - 18 - 19 - 20  
- 21 - 22 - 23 - 24 - 26 - 27 - 30 - 32 mm

920/25

920/42

● 920/55

920AN

125-250 mm

4,3 kg



MC21	€ 401,00	1	041500021
MCV17	64,50	1	041510017





C35

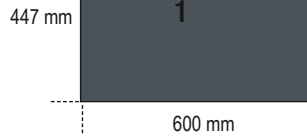

555-556



## MB12

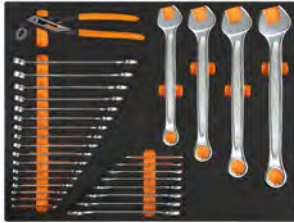

- 42 6 - 7 - 8 - 9 - 10 - 11 - 12 - 13 - 14 - 15 - 16 - 17 - 18 - 19 - 20 - 21 - 22 - 24 - 27 - 30 - 32 mm
- 55 6x7-8x9-10x11  
12x13-14x15  
16x17-18x19  
20x22 mm
- 1048N 250 mm

5,4 kg



	€		
MB12	665,00	1	024504212
MBV13	205,00	1	024524213

## MB37



- 920A 10 - 11 - 12 - 13 - 14 - 15 - 16 - 17 - 18 - 19 - 20 - 21 - 22 - 23 - 24 - 26 - 27 - 30 - 32 mm
- 920/21 125 mm
- 920/22 150 mm
- 920/25
- 920/42
- 920/55
- 111E 250 mm
- 1052 240 mm
- 1084BM 160 mm
- 1150BM 180 mm
- 1166BM 160 mm
- 1032 180 mm
- 1034 170 mm
- 1036 175 mm
- 1038 175 mm
- 900 4-4,5-5-5,5-6-7-8-9-10-11-12-13-14 mm
- 900/20 50 mm
- 900/21 150 mm
- 900/25
- 900BG/30
- 900/55
- 900/42

7,0 kg



	€		
MB37	1.020,00	1	024504237
MBV27	205,00	1	024524227

## MB39



- 920A 10 - 11 - 12 - 13 - 14 - 15 - 16 - 17 - 18 - 19 - 20 - 21 - 22 - 23 - 24 - 26 - 27 - 30 - 32 mm
- 920/21 125 mm
- 920/22 255 mm
- 920/25
- 920/42
- 920/55
- 920PE 5-6-8-10-12 mm
- 1032 180 mm
- 1034 170 mm
- 1036 175 mm
- 1038 175 mm
- 35 200 mm
- 1084BM 160 mm
- 1150BM 180 mm
- 1166BM 160 mm
- 1370 500 g
- 1390 35 mm

7,2 kg



	€		
MB39	930,00	1	024504239
MBV29	205,00	1	024524229

## MB44



- 1260 2,5x50 - 3x75 - 3,5x100 - 4x100 - 5,5x125 - 6,5x150 - 8x200 mm
- 1260N 4x30-6,5x30 mm
- 1262 PH0x60 - PH0x100 - PH1x80 - PH1x120 - PH2x100 - PH2x150 - PH3x150 mm
- 1262N PH1x30-PH2x30 mm
- 1253
- 96BPC/SC9
- 951 2,5-3-4-5-6-8 mm

2,8 kg



	€		
MB44	432,00	1	024504244
MBV44	205,00	1	024524244

## MB46



- 1260 3x75 - 4x100 - 5,5x125 - 6,5x150 mm
- 1262 PH0x60 - PH1x80 - PH2x100 mm
- 1267TX T8 - T10 - T15 - T20 - T25 - T30
- 96BPC/SC9
- 96T 2-2,5-3-4-5-6
- 1052 240 mm

2,8 kg



	€		
MB46	359,00	1	024504246
MBV46	205,00	1	024524246

## MB47



- 1260 3x75 - 4x100 - 5,5x125 - 6,5x150 mm
- 1262 PH0x60 - PH1x80 - PH2x100 mm
- 1260N 4x30 mm
- 1262N PH1x30 mm
- 96T 2,5-3-4-5-6-8 mm
- 96BPC/SC9
- 920A 10 - 11 - 12 - 13 - 14 - 15 - 16 - 17 - 18 - 19 - 20 - 21 - 22 - 23 - 24 - 26 - 27 - 30 - 32 mm
- 920/21 125 mm
- 920/22 250 mm
- 920/25
- 920/42
- 920/55

5,6 kg

12"



	€		
MB47	795,00	1	024504247
MBV70	205,00	1	024524270

## MB58

17



31	Ø 2-3-4-5-6 mm
32	Ø 4 mm
35	200 mm
1112	250 mm
1128BMX	147 mm
1370	500 g
1390	Ø 45 mm
■ 1719BMA...Q	200 mm
▲ 1719BMA...T	200 mm
■ 1719BMA...P	200 mm
▶ 1719BMA...M	200 mm
● 1719BMA...R	200 mm
1726	440 mm

4,5 kg



	€		
MB58	413,00	1	024504258
MBV55	205,00	1	024524255

## MB59

15



■ 1719BMA...Q	200 mm
▲ 1719BMA...T	200 mm
■ 1719BMA...P	200 mm
▶ 1719BMA...M	200 mm
● 1719BMA...R	200 mm
31	Ø 4-6 mm
32	Ø 4 mm
35	125-200 mm
1370	300 g
1390	Ø 35 mm
1692	5 m
1725	420 mm
1833XS/2	

3,4 kg



	€		
MB59	344,00	1	024504259
MBV57	205,00	1	024524257

## MB65

16



1719BMA...Q	200 mm
1719BMA...P	200 mm
1719BMA...T	200 mm
1719BMA...M	200 mm
1719BMA...R	200 mm
35	200 mm
○ 1032	180 mm
○ 1034	170 mm
● 1036	175 mm
● 1038	175 mm
1052	240 mm
◄ 1084BM	160 mm
≡ 1150BM	180 mm
● 1166BM	160 mm
1370	500 g
1390	Ø 35 mm

4,8 kg



	€		
MB65	535,00	1	024504265
MBV61	205,00	1	024524261

## MB63

60

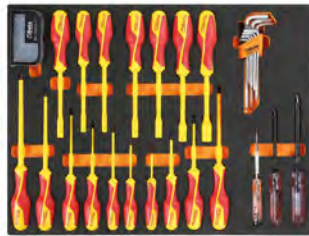

○ 96BPC/SC9	
● 1250	4x125 mm
⊕ 1251	PH1x125 mm
● 1253	
○ 943MQ	5,5-6-7-8-10-13 mm
⊕ 1272MQ	PH0x60 - PH1x80 - PH2x100 - PH3x150 mm
● 1274MQ	2,5x75 - 3x100 - 4x100 - 5,5x125 - 6,5x150 - 8x175 mm
● 860LP	0,5x3 - 0,6x4 - 0,8x5,5 - 1,0x5,5 - 1,2x6,5 mm
○ 860PE	2 - 2,5 - 3 - 4 - 5 - 6 - 8 - 10 mm
⊕ 860PH	PH0 - PH1 - PH2 - PH3 - PH4
⊕ 860PZ	PZ1 - PZ2 - PZ3 - PZ4
⊕ 860RTX	T9 - T10 - T15 - T20 - T25 - T27 - T30 - T40
882MSR 50	○ 1/4 ● 1/4
● 850MQ	

3,2 kg



	€		
MB63	555,00	1	024504263
MBV63	205,00	1	024524263

## MB64

20



55	6x7-8x9-10x11 - 12x13-14x15 - 16x17-18x19 - 20x22 mm
1048MQ	250 mm
◄ 1082MQ	140 mm
1128BSX	148 mm
1132MQ	230 mm
◄ 1142MQ	160 mm
≡ 1150MQ	180 mm
● 1166MQ	160 mm
● 1168MQ	160 mm
110MQ	250 mm
1777MQ	
993MQ	
1602	

4,1 kg



	€		
MB64	990,00	1	024504264
MBV62	205,00	1	024524262



**Beta**



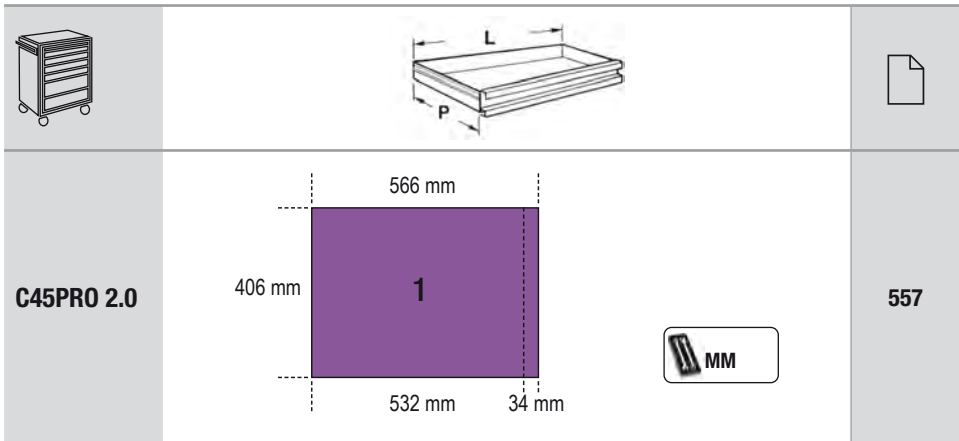

**C45PRO 2.0**

566 mm  
406 mm  
532 mm  
34 mm

1

MM

557

**MM11** 30



42 6-7-8-9-10-11-12-13-14-15-16-17-18-19-20-21-22-24-27-30-32 mm

96BPC/SC9 1,5-2-2,5-3-4-5-6-8-10 mm

4,5 kg

MM11	€ 451,00	1	024580011
MMV10	75,50	1	024590010

**MM26** 34



42 6-7-8-9-10-11-12-13-14-15-16-17-18-19-21-22-24-27 mm

111E 250 mm

123Q1/4

123Q3/8

123Q1/2

142 8-9-10-11-12-13-14-15-16-17-18-19 mm

4,3 kg

MM26	€ 725,00	1	024580026
MMV26	75,50	1	024590026



**MM30** 31

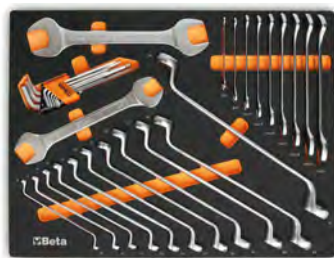

55 6x7-8x9-10x11-12x13-14x15-16x17-18x19-20x22-21x23-24x27-30x32 mm

90 6x7-8x9-10x11-12x13-14x15-16x17-18x19-20x22-21x23-24x27-30x32 mm

96BPC/SC9 1,5-2-2,5-3-4-5-6-8-10 mm

4,9 kg

MM30	€ 476,00	1	024580030
MMV30	75,50	1	024590030

**MM60** 23

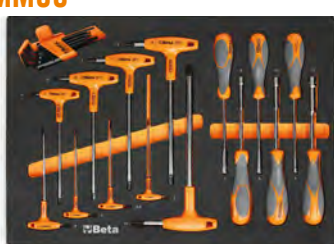

96T 2-2,5-3-4-5-6-7-8-10 mm

97BTX/SC8 T9-T10-T15-T20-T25-T27-T30-T40

944BX 5-6-7-8-10-13 mm

2,2 Kg

MM60	€ 444,00	1	024580060
MMV60	75,50	1	024590060

**MM63** 8



952 7-8-10-12-13-14-17-19 mm

3,4 kg

MM63	€ 410,00	1	024580063
MMV63	75,50	1	024590063

**MM100** 98



- 895/1
- 895/3
- 895/6
- 900 4-4,5-5-5,5-6-7-8-9-10-11-12-13-14 mm
- 900L 5-6-7-8-9-10-11-12-13 mm
- 900ME 3-4-5-6-7 mm
- 900LP 0,8x4-1x5,5-1,2x6,5-1,2x8 mm
- 900PH PH1-PH2-PH3-PH4
- 900TX T10-T15-T20-T25-T27-T30-T40
- 900/20 50 mm
- 900/20L 100 mm
- 900/21 150 mm
- 900/25
- 900BG/30
- 900/42
- 900/55
- 920A 8-10-11-12-13-14-15-16-17-18-19-20-21-22-23-24-26-27-28-30-32 mm
- 920/15
- 920/25
- 920AN/125 125 mm
- 920AN/250 250 mm
- 920/42
- 920/55
- 920FTX 10-12-14-16-18-20-22-24 mm
- 920AL 10-12-13-14-15-16-17-18-19-21-22

6,7 Kg

MM100	€ 1.330,00	1	024580100
MMV104	75,50	1	024590104







# Beta

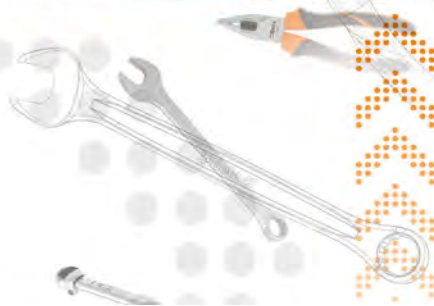

## MM105

107



- 895/1    □1/4-□1/4
- 895/3    □1/4-□3/8
- 895/6    □5/16-□1/2
- 900    4-4,5-5-5,5-6-7-8-9-10-11-12-13-14 mm
- 900L    5-6-7-8-9-10-11-12-13 mm
- 900ME    3-4-5-6-7 mm
- 900LP    0,8x4 - 1x5,5 - 1,2x6,5 - 1,2x8
- 900PH    PH1-PH2-PH3-PH4
- 900TX    T10 - T15 - T20 - T25 - T27 - T30 - T40
- 900/16    50-100-150 mm
- 900/25    176 mm
- 900BG/30    115 mm
- 900/42    125 mm
- 900/55    125 mm
- 910A    6-7-8-9-10-11-12-13-14-15-16-17-18-19-20-21-22 mm
- 910/15    □3/8-■1/4
- 910/16    □3/8-■1/2
- 910/21    125 mm
- 910/22    250 mm
- 910/25    210 mm
- 910/42    210 mm
- 910/55    200 mm
- 920A    8-10-11-12-13-14-15-16-17-18-19-20-21-22-23-24-26-27-28-30-32 mm
- 920/15    □1/2-■3/8
- 920/25    125-250 mm
- 920AN    305 mm
- 920/42    275 mm
- 920/55    275 mm
- 956E    16 mm (5/8") - 17,8 (11/16") - 20,8 (13/16")

7,2 kg

MM105	1.390,00	1	024580105
MMV107	75,50	1	024590107

## MM129

12



- 1032    180 mm
- 1034    170 mm
- 1036    175 mm
- 1038    175 mm
- 1048N    250 mm
- 1052    240 mm
- 1082BM    160 mm
- 1098    220 mm
- 1128BM    145 mm
- 1150BM    180 mm
- 1166BM    160 mm
- 1168BM    160 mm

2,9 Kg

MM129	471,00	1	024580129
MMV129	75,50	1	024590129

## MM210

25



- 1201E    2,5x50 - 3x75 - 4x100 - 5,5x125 - 6,5x150 - 8x200 mm
- 1201EN    4x30 mm
- 1202E    PH0x60 - PH1x80 - PH2x100 - PH3x150 mm
- 1202EN    PH1X30 mm
- 1207E/TX    T6 - T7 - T8 - T9 - T10 - T15 - T20 - T25 - T27 - T30 - T40 - T45
- 1253

2,1 kg

MM210	239,00	1	024580211
MMV210	75,50	1	024590210



# Beta

## MM230

25



- 30    Ø 2-3-4 mm
- 31    Ø 2-3-4-5-6-8 mm
- 32    Ø 4 mm
- 34    150 mm
- 35    200-250 mm
- 36    125 mm
- 1370    500 g
- 1390    Ø 35 mm
- 1692    3 m
- 1712TF
- 1719BMA...Q    200 mm
- 1719BMA...T    200 mm
- 1719BMA...P    200 mm
- 1719BMA...M    200 mm
- 1719BMA...R    200 mm
- 1737NX
- 1771    170 mm

3,2 Kg

MM230	479,00	1	024580230
MMV230	75,50	1	024590230

## MM400

29



- 3932U
- 3935    120 mm
- 3937    170 mm
- 3952    13 - 14 - 15 - 16 - 17 - 18 - 19 mm
- 3961 3,2
- 3961 3,3
- 3961 3,5
- 3961U    3,2 - 4,0 mm
- 3969    200 mm (x2)
- 3969K3    113 mm
- 3973/1
- 3973/2
- 3973/3
- 3973/4
- 3984/1
- 3984/2
- 3984/3
- 3984/4
- 3991    222 mm
- 3992    234 mm

3,1 kg

MM400	680,00	1	024580400
MMV400	75,50	1	024590400

### MM401



3921	440 mm
3948	
3953	
3955	30x32 mm - 32x36 mm
3967	289 mm
3971	

2,7 kg

MM401	€ 411,00	1	024580401
MMV401	€ 75,50	1	024590401

### VPM0

tabuleiro maleável para peças de pequenas dimensões

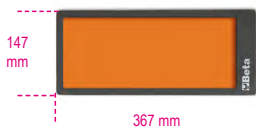

VPM0	€ 31,00	1	088870350
------	---------	---	-----------

### VPM3

tabuleiro maleável para peças de pequenas dimensões com 4 compartimentos

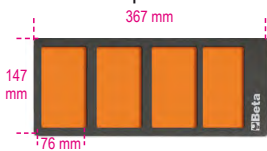

VPM3	€ 31,00	1	088870353
------	---------	---	-----------

### VPM7

tabuleiro maleável para peças de pequenas dimensões com 3 compartimentos, para blocos de gavetas C45PRO 2.0

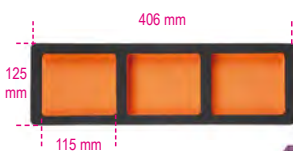

VPM7	€ 32,50	1	088870356
------	---------	---	-----------

### VPM8

tabuleiro maleável para peças de pequenas dimensões, para carros de ferramentas e blocos de gavetas C45PRO 2.0



VPM8	€ 25,00	1	088870357
------	---------	---	-----------

### VPM9



VPM9	€ 24,50	1	088870358
------	---------	---	-----------

### VPM7-C

tabuleiro maleável para peças de pequenas dimensões com 3 compartimentos, para carro de ferramentas C45PRO 2.0

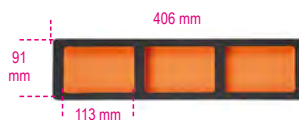

VPM7C	€ 38,00	1	088870360
-------	---------	---	-----------



## Módulos para ferramentas rígidos, série T

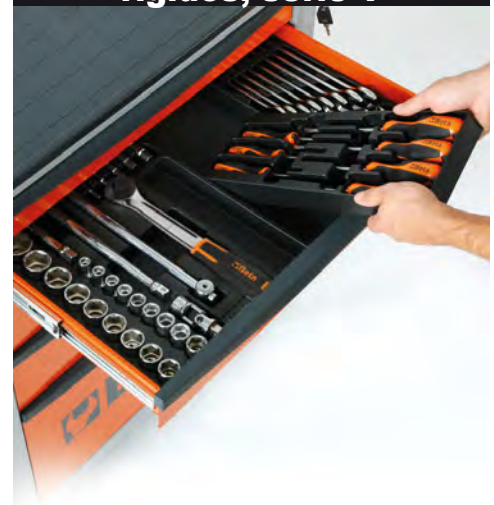

Composições de ferramentas em módulos para todos os modelos de carros com gavetas e para os carros.

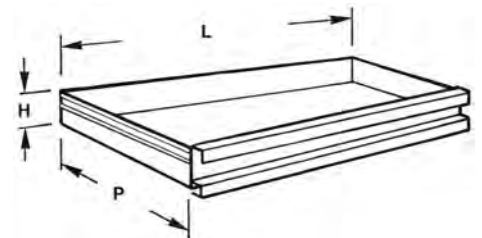

H mm	LxP mm
70	588x367

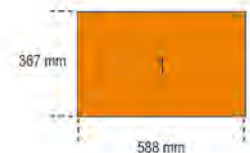
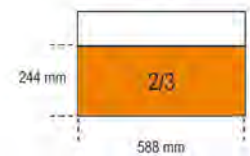
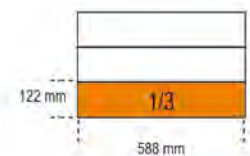
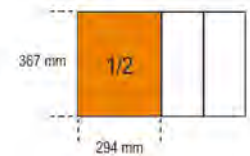
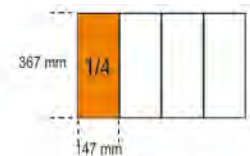

**T01**

42

6-7-8-10-11-12-13  
14-16-17-18-19-21  
22-24-27-30 mm

2,7 kg



T01	€ 300,00	1	024240001
TV10	€ 38,50	1	024000400

**T05**

42

6-7-8-9-10-11-12  
13-14-15-16-17  
18-19-20-21 mm

1,5 kg



T05	€ 228,00	1	024240005
TV15	€ 29,50	1	024000445

**T06**

42

22-24-27-30-32 mm

2,1 kg



T06	€ 163,00	1	024240006
TV16	€ 29,50	1	024000446

**T23**42INOX 8 - 10 - 11 - 12 - 13 -  
14 - 15 - 17 - 19 mm  
○96BPINOX 2,5-3-4-5-6-8-10 mm

1 kg



T23	€ 300,00	1	024240023
TV23	€ 29,50	1	024249906

**T24**

42AS

5/16-3/8-7/16-1/2  
9/16-5/8-11/16-3/4  
3/32-1/8-5/32-3/16  
1/4-5/16-3/8

○96AS/BG7

1 kg



T24	€ 176,00	1	024240024
TV20	€ 29,50	1	024000488

**T28**

42MP

6-7-8-9-10-11-12  
13-14-15-16-17  
18-19-20-21 mm

1,5 kg



T28	€ 326,00	1	024240028
TV15	€ 29,50	1	024000445

**T29**

42MP

22-24-27-30-32 mm

2,1 kg



T29	€ 215,00	1	024240029
TV16	€ 29,50	1	024000446

**T33**

55

6x7-8x9-10x11  
12x13-14x15  
16x17-18x19  
20x22 mm  
○96/SC9 1,5+10 mm

1 kg



T33	€ 104,00	1	024240033
TV20	€ 29,50	1	024000488

**T34**

55MP

6x7-8x9-10x11  
12x13-14x15  
16x17-18x19  
20x22 mm  
○96/SC9 1,5+10 mm

1 kg



T34	€ 131,00	1	024240034
TV20	€ 29,50	1	024000488

**T40**

90

6x7-8x9-10x11  
12x13-14x15  
16x17-18x19 mm

810 g



T40	€ 116,00	1	024240040
TV40	€ 29,50	1	024000456

**T41**

90

20x22-21x23  
24x26-25x28  
27x29 mm

1,5 kg



T41	€ 170,00	1	024240041
TV41	€ 29,50	1	024000457

**T31**

31

Ø 2-3-4-5-6 mm

32

Ø 4 mm

55

6x7-8x9-10x11  
12x13-14x15  
16x17-18x19  
20x22-21x23  
24x26-27x29  
30x32 mm  
○96N/SC9 1,5+10 mm

○96N/SC9

3 kg



T31	€ 248,00	1	024240031
TV30	€ 38,50	1	024000401



## T45

12



142 8-9-10-11-12  
13-14-15-16  
17-18-19 mm

1,3 kg



T45	€ 345,00	1	024240045
TV45	€ 29,50	1	024000498

## T46

12



142SN 8-9-10-11-12  
13-14-15-16  
17-18-19 mm

1,5 kg



T46	€ 405,00	1	024240046
TV46	€ 29,50	1	024000499

## T48

12



○96BPC/SC9 1,5+10 mm  
142C 8-9-10-11-12  
13-14-15-16  
17-18-19 mm

1,4 kg



T48	€ 289,00	1	024240048
TV47	€ 29,50	1	024000763

## T50

11



○96T 2-2,5-3-3,5-4-4,5  
5-6-7-8-10 mm

1,3 kg



T50	€ 195,00	1	024240050
TV50	€ 38,50	1	024000764

## T52

6



○96T 2-2,5-3-4-5-6 mm

350 g



T52	€ 94,00	1	024240052
TV52	€ 29,50	1	024000765

## T55

6



○97TTX T10-T15-T20  
T25-T27-T30

330 g



T55	€ 111,00	1	024240055
TV55	€ 29,50	1	024000766

## T59

14



111E 250 mm  
920/40 ■ 1/2  
○951 2,5-3-4-5-6-8 mm  
○953 4-5-6-8 mm  
1370 300 - 500 g

4,7 kg



T59	€ 486,00	1	024240059
TV60	€ 58,00	1	024000420

## T63

8



○952 7 - 8 - 10 - 12 - 13 - 14 - 17 - 19 mm

3,8 kg



T63	€ 373,00	1	024240063
TV63	€ 48,00	1	024000471

## T64

8



○952FTX E10-E12-E14  
○953TX T25 - T27 - T30 - T40 - T45

3,8 kg



T64	€ 450,00	1	024240064
TV63	€ 48,00	1	024000471

## T65

8



○953 3 - 3,5 - 4 - 5 - 6 - 7 - 8 - 10 mm

2,8 kg



T65	€ 351,00	1	024240065
TV63	€ 48,00	1	024000471

## T68

6



○951 2,5-3-4-5-6-8 mm

590 g



T68	€ 157,00	1	024240068
TV68	€ 29,50	1	024000470

## T73

10



○930 6x7 - 8x9 - 10x11 -  
12x13 - 14x15 - 16x17 -  
18x19 - 20x22 mm  
940/1 100 mm  
940/2 170 mm

1,3 kg



T73	€ 234,00	1	024240073
TV73	€ 29,50	1	024000418

## T75

16



933 7-8-9-10-11-12-13  
14-15-16-17-18-19  
21-22-24 mm

4,2 kg



T75	477,00	1	024240075
TV75	58,00	1	024000422

## T76

16



932 7-8-9-10-11-12-13  
14-15-16-17-18-19  
21-22-24 mm

4,2 kg



T76	477,00	1	024240076
TV75	58,00	1	024000422

## T77

10



933 6-7-8-10-11-12-13  
14-17-19 mm

1,4 kg



T77	238,00	1	024240077
TV77	29,50	1	024000474

## T80

29



920A 10-11-12-13-14  
15-16-17-18-19  
20-21-22-23-24  
26-27-30-32 mm  
920ME 5-6-8-10-12 mm  
920/21 125 mm  
920/22 255 mm  
920/25 305 mm  
920/42 305 mm  
920/55

4,1 kg

12"



T80	451,00	1	024240080
TV80	38,50	1	024000403

## T81

29



920B 10-11-12-13-14  
15-16-17-18-19  
20-21-22-23-24  
26-27-30-32 mm  
920ME 5-6-8-10-12 mm  
920/21 125 mm  
920/22 255 mm  
920/25 305 mm  
920/42 305 mm  
920/55

4,1 kg

12"



T81	451,00	1	024240081
TV80	38,50	1	024000403

## T82

29



920A 10-11-12-13-14  
15-16-17-18-19  
20-21-22-23-24  
26-27-30-32 mm  
920ME 5-6-8-10-12 mm  
920AN/125 125 mm  
920AN/250 250 mm  
920/25 305 mm  
920/42 305 mm  
920/55

4,1 kg

12"



T82	466,00	1	024240082
TV80	38,50	1	024000403

## T83

24



920A 10-11-12-13-14  
15-16-17-18-19  
20-21-22-23-24  
26-27-30-32 mm  
920/21 125 mm  
920/22 255 mm  
920/25 305 mm  
920/42 305 mm  
920/55

3,6 kg

12"



T83	357,00	1	024240083
TV83	38,50	1	024000402

## T85

81



861LP 0,5x3 - 0,6x4,5 - 0,8x5,5 - 1x5,5  
- 1,2x6,5 - 1,2x8 - 1,6x8 mm  
861PE 2 - 2,5 - 3 - 4 - 5 - 6 - 8 - 10 mm  
861PH PH0 - PH1 - PH2 - PH3  
861PZ PZ1 - PZ2 - PZ3  
861TX T6 - T7 - T8 - T9 - T10 - T15 - T20  
- T25 - T27 - T30 - T40  
861RTX T9 - T10 - T15 - T20 - T25 - T27 -  
T30 - T40  
861TRW 1-2-3-4-5-6 mm  
861TQS 0 - 1 - 2 - 3 - 4 - 5 - 6 - 8 - 10 mm  
861SP 4-6-8-10-12 mm  
851SR 230 mm  
900 4-4,5-5-5,5-6-7-8-9  
10-11-12-13-14 mm  
900/21 150 mm  
900/25 41 mm  
900BG/30 176 mm  
900/42 115 mm  
900/55 125 mm  
194 1/4x5/16

1,0 kg

14"



T85	379,00	1	024240085
TV85	38,50	1	024000747

## T91

25



900 4-4,5-5-5,5-6  
7-8-9-10-11  
12-13-14 mm  
900ME 2,5-3-4-5-6-8 mm  
900/20 50 mm  
900/21 150 mm  
900/25 150 mm  
900BG/30 115 mm  
900/42 115 mm  
900/55

560 g

14"



T91	246,00	1	024240091
TV90	29,50	1	024000447

## T92

22



910A 6-7-8-9-10-11-12-13  
14-15-16-17-18-19  
20-21-22 mm  
910/21 125 mm  
910/22 250 mm  
910/25 250 mm  
910/42 210 mm  
910/55

1,5 kg

38"



T92	282,00	1	024240092
TV92	29,50	1	024000458



## T99



- 920INOX-A 10-12-13-14-15-16-17  
18-19-21-22-24-27  
30-32mm
- 920/55INOX



2,7 kg

12"



T99	1.290,00	€	1	024240099
TV99	29,50	€	1	024249908

## T100



- 920A 10-12-13-14-15  
16-17-18-19-21  
22-24 mm
- 920/21 125 mm
- 920/25
- 920/42 305 mm
- 920/55

2,1 kg

12"



T100	252,00	€	1	024240100
TV100	29,50	€	1	024000495

## T101



- 920B 10-12-13-14-15  
16-17-18-19-21  
22-24 mm
- 920/21 125 mm
- 920/25
- 920/42 305 mm
- 920/55

2,1 kg

12"



T101	252,00	€	1	024240101
TV100	29,50	€	1	024000495

## T102



- 920AS 3/8-7/16-1/2  
9/16-5/8-11/16  
3/4-13/16-7/8  
15/16-1-1.1/16
- 920/21 125 mm
- 920/25
- 920/42 305 mm
- 920/55

2,1 kg

12"



T102	275,00	€	1	024240102
TV100	29,50	€	1	024000495

## T103



- 900L 6-7-8-9-10-11-12 mm
- 920AL 13-14-16-17-18-19  
21-22-24-27 mm

1,1 kg

14" 12"



T103	324,00	€	1	024240103
TV103	29,50	€	1	024000748

## T105



- 928A 22-24-27-30-32-34  
36-38-41-46-50 mm

4,9 kg

3/4"



T105	329,00	€	1	024240105
TV105	29,50	€	1	024000484

## T106



- 928/21 200 mm
- 928/22 380 mm
- 928/42 450 mm
- 928/55

4,5 kg

3/4"



T106	345,00	€	1	024240106
TV106	29,50	€	1	024000485

## T111



- 720 10-13-15-17-18-19-21  
22-24-27-30-32 mm
- 720LC 17-19-21 mm
- 720/21 125 mm

2,7 kg

12"



T111	278,00	€	1	024240111
TV111	29,50	€	1	024000746

## T112



- 861TX ● 1/4-T6+T15
- 866TX ● 5/16-T20+T55
- 895/1 ○ 1/4x□1/4
- 895/6 ○ 5/16x□1/2
- 900FTX □ 1/4-E4+E10
- 920FTX □ 1/2-E12+E24
- 920TX □ 1/2-T55L-T60-T70L

1,3 kg

14" 12"



T112	328,00	€	1	024240112
TV112	29,50	€	1	024000480

## T113



- 920PE 5L-6L-7L-8L-10L
- 920TX T40L-T45L  
T55L-T70L
- 920XZN M6L-M8L-M12L

1,5 kg

12"



T113	288,00	€	1	024240113
TV113	29,50	€	1	024000489

## T122



- 666/20 40 - 200 Nm

1,2 kg

12"



T122	319,00	€	1	024240122
TV122	29,50	€	1	024000768

## T123



- 1082G 160 mm
- 1150G 180 mm
- 1166G 160 mm

550 g



T123	88,00	€	1	024240123
TV135	29,50	€	1	024000762



## T124



- ◄ 1082GBM 160 mm
- ≡ 1150GBM 180 mm
- 1166GBM 160 mm

640 g



T124	€ 114,00	1	024240124
TV135	€ 29,50	1	024000762

## T135



- ◄ 1082MQ 160 mm
- ≡ 1150MQ 180 mm
- 1166MQ 160 mm

⚡ 1000 V

750 g



T135	€ 186,00	1	024240135
TV135	€ 29,50	1	024000762

## T136



- 1048MQ 250 mm
- 1777MQ/U 190 mm

⚡ 1000 V

700 g



T136	€ 133,00	1	024240136
TV136	€ 29,50	1	024000438

## T137



- ◄ 1084BM 160 mm
- ≡ 1150BM 180 mm
- 1166BM 160 mm

750 g



T137	€ 127,00	1	024240137
TV130	€ 29,50	1	024000451

## T138



- ◄ 1084 160 mm
- ≡ 1150 180 mm
- 1166 160 mm

650 g



T138	€ 104,00	1	024240138
TV130	€ 29,50	1	024000451

## T140



- 1032 140x0,9 - 180 mm
- 1034 170 mm
- 1036 140x1,3 - 175 mm
- 1038 175 mm
- ◄ 1084 160 mm
- 1128BM 145 mm

1,1 kg



T140	€ 255,00	1	024240140
TV140	€ 38,50	1	024000405

## T144



- 1048N 250 mm
- 1052 240 mm
- 1112 250 mm
- ≡ 1150 180 mm

1,8 kg



T144	€ 153,00	1	024240144
TV143	€ 38,50	1	024000409

## T145



- 1032 180 mm
- 1034 170 mm
- 1036 175 mm
- 1038 175 mm

640 g



T145	€ 143,00	1	024240145
TV145	€ 29,50	1	024000448

## T146



- 1032 140x0,9 mm
- 1032 225 mm
- 1036 140x1,3 mm
- 1036 225 mm

700 g



T146	€ 148,00	1	024240146
TV146	€ 29,50	1	024000449

## T151



- 1047 240 mm
- 1057A 240 mm

1,3 kg



T151	€ 127,00	1	024240151
TV150	€ 29,50	1	024000462

## T153



- 1048N 250 mm
- 1052 240 mm

1,1 kg



T153	€ 85,50	1	024240153
TV150	€ 29,50	1	024000462

## T156



- ◄ 1082 160 mm
- ≡ 1150 180 mm
- 1048N 250 mm

1 kg



T156	€ 108,00	1	024240156
TV148	€ 29,50	1	024000500

## T157



- 1082BM 160 mm
- 1150BM 180 mm
- 1048BM 250 mm

1,1 kg



T157	€ 140,00	1	024240157
TV148	€ 29,50	1	024000500

## T160



- 1290 3x75, 3x100, 4x100, 4x150, 5,5x100, 5,5x150, 6,5x150, 8x150, 10x200 mm
- 1290N 4x30, 6,5x30 mm

1,3 kg



T160	€ 153,00	1	024240160
TV160	€ 38,50	1	024000706

## T161



- 1292 PH0x60, PH0x100, PH1x80, PH1x120, PH2x100, PH2x150, PH3x150 mm
- 1292N PH1x30, PH2x30 mm

1 kg



T161	€ 121,00	1	024240161
TV161	€ 38,50	1	024000707

## T164



- 952 8-10-13-17-19 mm
- 959 16 mm (5/8") - 20,8 mm (13/16")
- 1260 3x75 - 4x100 - 5,5x100 - 6,5x150 - 10x200 mm
- 1262 PH0x60 - PH1x80 - PH2x100 - PH3x150 mm

5 kg



T164	€ 520,00	1	024240164
TV61	€ 58,00	1	024000721

## T167



- 1260 3x75, 3x100, 4x100, 4x150, 5,5x100, 5,5x150, 6,5x150, 8x150, 10x200 mm
- 1260N 4x30, 6,5x30 mm

1,3 kg



T167	€ 124,00	1	024240167
TV160	€ 38,50	1	024000706

## T168



- 1262 PH0x60, PH0x100, PH1x80, PH1x120, PH2x100, PH2x150, PH3x150 mm
- 1262N PH1x30, PH2x30 mm

1 kg



T168	€ 98,50	1	024240168
TV161	€ 38,50	1	024000707

## T170



- 1290 2,5x50, 3x75, 3,5x100, 4x125, 5,5x100, 5,5x150, 6,5x150 mm

450 g



T170	€ 83,50	1	024240170
TV170	€ 29,50	1	024000741

## T171



- 1290 8x150, 8x200, 10x200 mm
- 1290N 4x30, 6,5x30 mm

750 g



T171	€ 92,00	1	024240171
TV171	€ 29,50	1	024000742

## T172



- 1292 PH0x60, PH0x100, PH1x80, PH1x120, PH2x100, PH2x150 mm

450 g



T172	€ 76,00	1	024240172
TV172	€ 29,50	1	024000743

## T173



- 1292 PH3x150, PH4x200 mm
- 1292N PH1x30, PH2x30 mm

560 g



T173	€ 74,50	1	024240173
TV173	€ 29,50	1	024000744

## T175



- 1297TX T6-T7-T8-T9, T10-T15-T20

410 g



T175	€ 119,00	1	024240175
TV175	€ 29,50	1	024000760

## T176



- 1297TX T25-T27-T30, T40-T45

640 g



T176	€ 110,00	1	024240176
TV176	€ 29,50	1	024000761

# T177



1298RTX T9-T10-T15  
T20-T25-T27  
T30-T40

680 g



T177	€ 166,00	1	024240177
TV177	€ 29,50	1	024000759

# T180



1290 3x75  
4x100  
5,5x150  
6,5x150 mm  
1292 PH0x60  
PH1x80  
PH2x100 mm

480 g



T180	€ 86,50	1	024240180
TV180	€ 29,50	1	024000701

# T183



1292L PH1x400-PH2x400 mm  
1294L 3x300-4x400-5x400 mm

580 g



T183	€ 118,00	1	024240183
TV183	€ 29,50	1	024000497

# T198

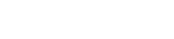

1260 3x75  
4x100  
5,5x150  
6,5x150 mm  
1269PZ P20 - PZ1 - PZ2

490 g



T198	€ 74,00	1	024240198
TV180	€ 29,50	1	024000701

# T199



1260 2,5x50  
3x75  
3,5x100  
4x125  
5,5x100  
5,5x150  
6,5x150 mm

490 g



T199	€ 67,50	1	024240199
TV170	€ 29,50	1	024000741

# T201



1260 8x200  
10x150  
10x200 mm  
1260N 4x30  
6,5x30 mm

680 g



T201	€ 72,00	1	024240201
TV171	€ 29,50	1	024000742

# T202



1262 PH0x60  
PH0x100  
PH1x80  
PH1x120  
PH2x100  
PH2x150 mm

490 g



T202	€ 62,00	1	024240202
TV172	€ 29,50	1	024000743

# T204



1262 PH3x150  
PH4x200 mm  
1262N PH1x30  
PH2x30 mm

610 g



T204	€ 60,00	1	024240204
TV173	€ 29,50	1	024000744

# T205



1267TX T6-T7-T8-T9  
T10-T15-T20

460 g



T205	€ 88,00	1	024240205
TV175	€ 29,50	1	024000760

# T206



1267TX T25-T27-T30  
T40-T45

710 g



T206	€ 89,50	1	024240206
TV176	€ 29,50	1	024000761

# T207



1268RTX T9-T10-T15  
T20-T25-T27-T30

760 g



T207	€ 107,00	1	024240207
TV207	€ 29,50	1	024000758

# T208



1260 3x75  
4x100  
5,5x150  
6,5x150 mm  
1262 PH0x60  
PH1x80  
PH2x100 mm

530 g



T208	€ 70,00	1	024240208
TV180	€ 29,50	1	024000701



## T209



- 1262L PH1x400-PH2x400 mm
- 1264L 3x300 - 4x400 - 5x400 mm

580 g



T209	€ 87,00	1	024240209
TV183	€ 29,50	1	024000497

## T211



- 1201E 2,5x50
- 3x75
- 3,5x100
- 4x125
- 5,5x100
- 5,5x150
- 6,5x150 mm

490 g



T211	€ 47,50	1	024240211
TV170	€ 29,50	1	024000741

## T213



- 1202E PH0x60
- PH1x80
- PH1x120
- PH2x100
- PH2x150
- PH3x150 mm

490 g



T213	€ 52,00	1	024240213
TV212	€ 29,50	1	024000440

## T216



- 1207E/TX T6-T7-T8-T9
- T10-T15-T20

410 g



T216	€ 65,00	1	024240216
TV175	€ 29,50	1	024000760

## T221



- 1201E 3x75
- 4x100
- 5,5x150
- 6,5x150 mm
- 1202E PH0x60
- PH1x80
- PH2x100 mm

530 g



T221	€ 49,50	1	024240221
TV180	€ 29,50	1	024000701

## T226



- 1274MQ 3x100
- 4x100
- 5,5x125
- 6,5x150 mm
- 1272MQ PH0x60
- PH1x80
- PH2x100 mm

⚡ 1000 V

460 g



T226	€ 108,00	1	024240226
TV180	€ 29,50	1	024000701

## T227



- 944BX 5-6-7-8-10-13 mm

490 g



T227	€ 151,00	1	024240227
TV227	€ 29,50	1	024000705

## T228



- 1290INOX 3x75 - 4x100 - 5,5x150 - 6,5x150 mm
- 1292INOX PH0x60
- PH1x80 - PH2x100 mm



480 g



T228	€ 97,00	1	024240228
TV180	€ 29,50	1	024000701

## T231



- 1370 400 g
- 1390 Ø 35 mm
- ▲ 1719BMA/T 200 mm
- 1719BMA/P 200 mm
- ▶ 1719BMA/M 200 mm

1,7 kg



T231	€ 133,00	1	024240231
TV230	€ 38,50	1	024000411

## T233



- 35 100-200 mm
- 1370F 32 mm
- 1390 Ø 35 mm

1,3 kg



T233	€ 121,00	1	024240233
TV232	€ 29,50	1	024000452

## T234



- 35 100-200 mm
- 1370 300 g
- 1390 Ø 35 mm

1,3 kg



T234	€ 111,00	1	024240234
TV232	€ 29,50	1	024000452

## T236



- 1719BMA/Q 200 mm
- ▲ 1719BMA/T 200 mm
- 1719BMA/P 200 mm
- ▶ 1719BMA/M 200 mm
- 1719BMA/R 200 mm

870 g



T236	€ 109,00	1	024240236
TV235	€ 29,50	1	024000453

## T239



31BM Ø 2-3-4-5-6-8 mm  
32 Ø 4 mm



850 g



T239	145,00	€	1	024240239
TV239	29,50	€	1	024000439

## T241



1500N/1  
1500N/3  
1516/1



4,2 kg



T241	333,00	€	1	024240241
TV241	38,50	€	1	024000414

## T259



○ 96BP 2,5-3-4-5  
6-8-10 mm  
○ 96N 12 mm  
● 861MIX/A31  
○  
+  
+  
+  
+  
895/1



950 g



T259	151,00	€	1	024240259
TV263	29,50	€	1	024000492

## T264



1491 Ø 65+110 mm  
■ 1494 ■ 10 mm  
○ 1494E ○ 8 - 9 - 10 - 11 - 12 - 14 - 17 mm  
○ 1494Q ○ 8-9,5-12-13 mm  
△ 1494T △ 9,5  
○ 1494XZN ○ 16  
1496C ■ 8x ■ 10 mm



2,1 kg



T264	250,00	€	1	024240264
TV264	29,50	€	1	024000466

## T270



430 M3 - 4 - 5 - 6 - 7 - 8 - 9  
10 - 12 - 14 - 16 - 18 - 20  
433 M6x0,75 - M8x1 - M10x1,25  
M12x1,5 - M14x1,5  
M16x1,5 - M18x1,5  
440 M3 - 4 - 5 - 6 - 7 - 8 - 9  
440A M10 - 12 - 14 - 16 - 18 - 20  
441 M6x0,75 - M8x1,0  
441A M10x1,25 - M12x1,5  
M14x1,5 - M16x1,5  
M18x1,5

4,3 kg



T270	580,00	€	1	024240270
TV270	38,50	€	1	024000481

## T271



1741 250 mm  
1741RV2,9K 2,9x6 mm (100)  
1741RV3,2K 3,2x8 mm (100)  
1741RV3,8K 3,8x10 mm (100)  
1741RV4K 4x12 mm (100)  
1741RV4,8K 4,8x12 mm (100)



1,4 kg



T271	81,00	€	1	024240271
TV271	29,50	€	1	024000475

## T273



435/1,5 M3+M12  
435/3 M5+M21  
436/1 □ 2,0+5,0 mm (M3+M8)  
436/2 □ 4,6+8 mm (M5+M12)  
444/1 Ø 25,4 mm  
444/2 Ø 38,1 mm  
1707 W 62+4x1"



2,1 kg



T273	262,00	€	1	024240273
TV272	38,50	€	1	024000482

## T279



1112 250 mm  
1128BM 145 mm  
1726 400 mm  
1728BM (x5)  
1751N 200 cc

1,5 kg



T279	142,00	€	1	024240279
TV285	48,00	€	1	024000487

## T284



1128BMX 147 mm  
1130BMX 185 mm  
■ 1719BMA...Q 200 mm  
▲ 1719BMA...T 200 mm  
■ 1719BMA...P 200 mm  
▶ 1719BMA...M 200 mm  
● 1719BMA...R 200 mm  
1726BM 400 mm  
1728BM  
1771BM 170 mm  
1778V18 185 mm

3,3 kg



T284	282,00	€	1	024240284
TV286	58,00	€	1	024249904

## T291



1479RB/1  
1479RB/2  
1479RB/3



600 g



T291	113,00	€	1	024240291
TV291	29,50	€	1	024000472

 Beta

## T294



1692 5 m  
1725CR  
1771RL  
1771 170 mm



590 g



T294	€ 78,00	1	024240294
TV294	€ 29,50	1	024000491

## T297



1651DGTB  
1682 300 mm  
1691BM 5 m



490 g



T297	€ 157,00	1	024240297
TV296	€ 29,50	1	024000749

## VP1 - VP2

tabuleiros em plástico para peças de pequenas dimensões para todos os modelos de carros de ferramentas: RSC22, RSC23, RSC23C

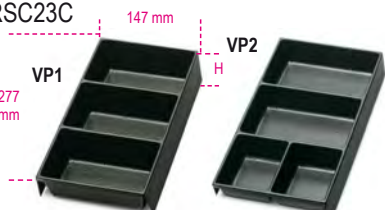

VP1	H mm 50	€ 16,70	1	088880351
VP2	H mm 35	€ 16,70	1	088880352

## VP3 - VP4

tabuleiros em plástico para peças de pequenas dimensões em plástico para todos os modelos de blocos de gavetas, carros de ferramentas e trolleys

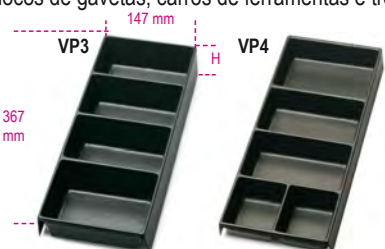

VP3	H mm 50	€ 17,60	1	088880353
VP4	H mm 35	€ 17,60	1	088880354

## VP5

tabuleiro em plástico para peças de pequenas dimensões com 2 compartimentos



VP5	H mm 45	€ 19,90	1	088880355
-----	---------	---------	---	-----------

## VP6

tabuleiro em plástico para peças de pequenas dimensões com 6 compartimentos



VP6	H mm 45	€ 20,20	1	088880359
-----	---------	---------	---	-----------

## VP7-C

tabuleiro maleável com 3 divisórias, para carro de ferramentas C45PRO



VP7-C	H mm 45	€ 14,80	1	088880361
-------	---------	---------	---	-----------

## VP-3SC

tabuleiro em plástico para peças de pequenas dimensões com 3 compartimentos, para carro de ferramentas C04TSS-7

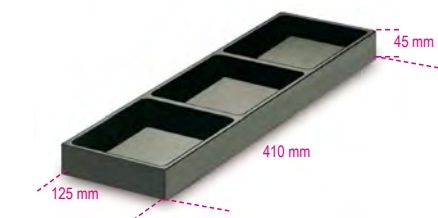

VP-3SC	H mm 45	€ 21,20	1	088880356
--------	---------	---------	---	-----------

## VP-LS

tabuleiro em plástico para peças de pequenas dimensões, para carro de ferramentas C04TSS-7



VP-LS	H mm 45	€ 14,40	1	088880357
-------	---------	---------	---	-----------

## 8889P1

divisórias paralelas para ref. RSC22, RSC23, RSC23C e C27S  
gaveta 588x277 mm



8889P1/5	h 50 mm	€ 56,00	1	088890005
8889P1/7	h 70 mm	€ 57,50	1	088890007

## 8889C1

divisórias em cruz para ref. RSC22, RSC23, RSC23C e C27S  
para gaveta 588x277 mm

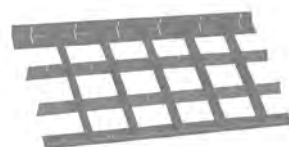

8889C1/5	h 50 mm	€ 75,00	1	088890015
8889C1/7	h 70 mm	€ 76,50	1	088890017

## 8889P2

divisórias paralelas para gaveta standard  
588x367 mm



8889P2/7	h 70 mm	€ 67,50	1	088890107
----------	---------	---------	---	-----------

## 8889C2

divisórias em cruz para gaveta standard  
588x367 mm

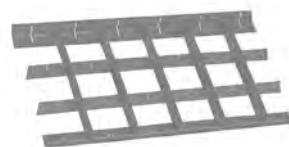

8889C2/7	h 70 mm	€ 86,50	1	088890117
----------	---------	---------	---	-----------

## 8889P3

divisórias paralelas para ref. RSC24AXL, RSC24AXLP/7, RSC24AXXL

para gaveta 882x367 mm



8889P3/7	h 70 mm	€ 108,00	1	088890207
----------	---------	----------	---	-----------



## 8889C3

divisórias em cruz para RSC24AXL,  
RSC24AXLP/7, RSC24AXXL  
para gaveta 882x367 mm



8889C3/7	h 70 mm	€ 131,00	1	088890217

## 8889P4

divisórias paralelas para ref. C41  
para gaveta 418x205 mm

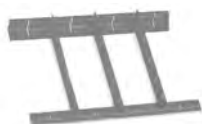

8889P4/7	h 70 mm	€ 45,50	1	088890307

## 8889I4

divisórias em cruz para ref. y C41  
para gaveta 418x205 mm



8889C4/7	h 70 mm	€ 54,50	1	088890317

## 8889PS

divisórias paralelas para ref. C45PRO 2.0 M4/  
M5/M7/M8/M3A/ACT/TC  
gaveta 566x406 mm



8889PS/7	h 70 mm	€ 80,00	1	088890407

## 8889CS

divisórias em cruz para ref. C45PRO 2.0 M4/  
M5/M7/M8/M3A/ACT/TC  
gaveta 566x406 mm



8889CS/7	h 70 mm	€ 97,50	1	088890417

## 8889C6

divisórias em cruz para ref. C35  
para gaveta 600x447 mm



	h mm	€	1	
8889C6/7,5	75 mm	41,50	1	088890475
8889C6/10	100 mm	41,00	1	088890480
8889C6/15	150 mm	51,00	1	088890485
8889C6/20	200 mm	79,50	1	088890490

## SB

guia porta-chaves

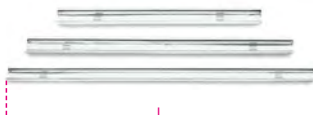

	L mm	€	10	
SB1	210	4,25	10	088880201
SB2	280	4,70	10	088880202
SB3	360	4,95	10	088880203

## PM 1/2-Q5

calha magnética para chaves de caixa



PM 1/2-Q5	€	1	088880233
	52,00		

## MB

molas para guia SB



	□	€	50	
MB0	1/4	1,26	50	088880210
MB1	3/8	1,26	50	088880211
MB2	1/2	1,26	50	088880212

## KIT/GPS



	L mm	€	50	
KIT/GPS-40 mm	40	2,44	50	088880119
KIT/GPS-90 mm	90	3,55	50	088880117

## VE1



VE1	€	20	088880120
	0,86		

## GM

ganchos de mola com parafusos de expansão  
VE1



Ø mm	€	5	
6,5	7,80	5	088880250
9,5	8,20	5	088880251
13	8,20	5	088880252
16	9,60	5	088880253
19	10,00	5	088880254
25	9,50	5	088880255

## S55/8

suporte para 8 chaves de bocas, em chapa  
metálica

• fornecido com 3 parafusos de expansão VE1

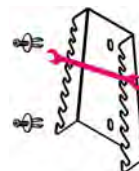

S55/8	€	1	088880420
55/S8	27,00		
55AS/8			
55MP/S8			

## S55/12

suporte para 12 chaves de bocas, em chapa  
metálica

• fornecido com 3 parafusos de expansão VE1

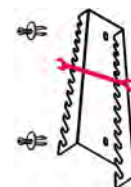

S55/12	€	1	088880421
55/S12	32,50		
55/S12X			
55AS/12			
55MP/S12			

## ST2P

suporte para alicates, em chapa metálica

• Fornecido com 3 parafusos de expansão VE1

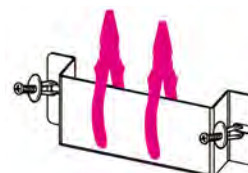

ST2P	€	1	088880422
	29,50		

## TSPP

suporte para ferramentas, em plástico

- Fornecido com 3 parafusos de expansão VE1

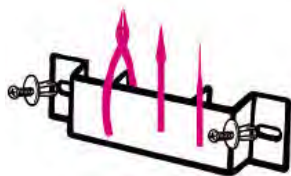

TSPP € 6,60 1 088880402

## S952/10

suporte para 10 chaves em T, em chapa metálica

- Fornecido com 3 parafusos de expansão VE1

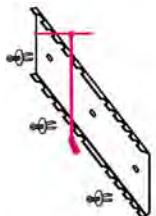

S952/10 € 35,00 1 088880423

## S1719BM

suporte para 5 limas, em chapa metálica

- fornecido com 3 parafusos de expansão VE1



S1719BM € 20,20 1 088880404  
 1719BMA: Q-T-P-M-R  
 1719BMD: Q-T-P-M-R  
 1719BMX: Q-T-P-M-R

## SGN

suporte para 2 mini chaves de fendas, em chapa metálica

- fornecido com 3 parafusos de expansão VE1



SGN € 10,20 1 088880405  
 1290N-1292N-1299N/PZ  
 1260N-1262N-1269N/PZ  
 1201EN-1202EN-1209EN/PZ

# Beta

## CB/2

tabuleiro rígido para chaves de caixa 1/2" e acessórios, vazio

- apenas para item C54S

12"



CB/2 € 31,00 1 088880411  
 920A/920B  
 10=24+26-27  
 28-30-32 mm  
 920/21-920/22-920/25-  
 920/42-920/55

## S42/17

suporte para 17 chaves mistas boca/luneta, em chapa metálica

- Fornecido com 3 parafusos de expansão VE1



S42/17 € 34,50 1 088880428  
 42/S17  
 42MP/S17  
 42/S17X  
 42AS/17  
 142/S17

## S951/6

suporte para 6 chaves em T com macho sextavado, em chapa metálica

- fornecido com 3 parafusos de expansão VE1

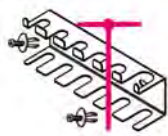

S951/6 € 22,80 1 088880429  
 951/S6  
 951AS/S6X  
 951TX/S6

## SPG11 - S1203/8

suporte para chaves de fendas, em chapa metálica

- fornecido com 3 parafusos de expansão VE1



SPG11 € 23,70 1 088880910  
 n.8 Ø = 7 mm  
 n.2 Ø = 10 mm  
 n.1 Ø = 12 mm  
 S1203/8 € 25,00 1 088880430  
 1203E/S8  
 1263/D8  
 1293/S8

## S96T/8

suporte para 8 chaves macho sextavadas, com punho de binário elevado, em chapa metálica

- Fornecido com 3 parafusos de expansão VE1



S96T/8 € 25,00 1 088880431  
 96T/AS8  
 96T/S8  
 97TTX/S8

## 96T/SPV

suporte para 11 chaves macho sextavadas, com punho de binário elevado, em chapa metálica

- fornecido com 3 parafusos de expansão VE1

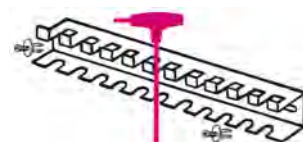

96T/SPV € 49,00 1 000960958  
 96T/S11  
 97TTX/S11

# Beta

# Beta



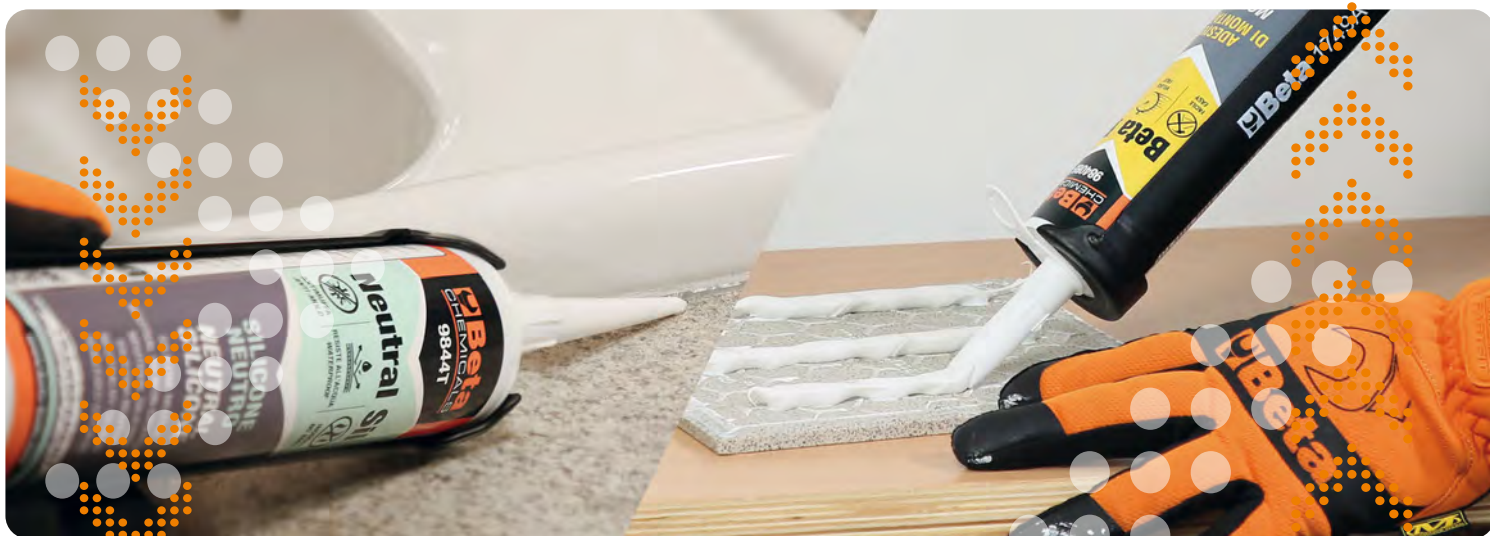

## Produtos Anaeróbicos

Os produtos anaeróbicos permitem o preenchimento completo de pequenas irregularidades existentes no metal, para que a tensão mecânica possa ser distribuída por toda a superfície. Estes endurecem na ausência total de oxigénio e vedam completamente juntas ou rosca de água, gás, óleo, combustível e fluidos industriais. Estão disponíveis em três diferentes forças - alta (H), média (M) e baixa (L) - e em diferentes packs, para satisfazer diferentes necessidades.

### Adesivo

Adesivo multiusos de montagem instantânea, adequado para uma variedade de materiais, incluindo betão, vidro, gesso cartonado, cerâmica, madeira, metal e plásticos. Tendo por base o inovador efeito de sucção, garante uma aderência rápida e firme, sem necessidade de fixação.

### Selantes

A gama de selantes da Beta é composta por três produtos. O selante acrílico é ideal para vedar eficazmente escadas, rodapés, caixilhos de portas e janelas e muito mais. É pintável e durável, resultando em juntas perfeitas e duradouras. O silicone acético convencional é a escolha perfeita para vedar juntas em cozinhas e casas de banho. Este produto garante uma excelente selagem em superfícies esmaltadas, vidro, madeira pintada e cerâmica. Por fim, o silicone neutro profissional é inodoro, resistente ao bolor, aos raios UV e às intempéries. É ideal para a selagem de casas de banho e cozinhas, juntas de dilatação em betão, alvenaria e paredes de vidro.

### Espuma de poliuretano

A espuma de poliuretano, que garante versatilidade e elevado desempenho, é o parceiro ideal na indústria da construção, para aplicações de isolamento, selagem e fixação. Expande-se rapidamente, aderindo perfeitamente a diversos materiais e é resistente tanto à humidade como a temperaturas extremas. Possui excelentes propriedades de isolamento térmico e acústico, resultando numa maior eficiência energética e conforto ambiental.

### Selante de silicone

Os selantes de silicone permitem uma selagem elástica permanente, evitando que substâncias de pequena dimensão (detritos, pó...) penetrem nas juntas e substituem as juntas pré-formadas. Com base nas suas propriedades elásticas, podem absorver movimentos, sem expansão ou quebra. Os selantes de silicone polimerizam ao reagir com a humidade atmosférica e formam juntas elásticas e duráveis.

### Cola Instantânea

Adesivo à base de cianoacrilato de etilo para juntas estruturais em vários materiais.

### Aerosóis

Ampla gama de produtos em spray, para utilizações tão diversas como lubrificar, olear, desbloquear, galvanizar e limpar.

### Líquidos

Desenvolvidos para remoção de incrustações e ferrugem de componentes mecânicos e objetos em metal. Ideais para a utilização com os tanques de limpeza ultrassónicos 1895.



## ATENÇÃO

Países onde os produtos químicos Beta podem ser distribuídos: Áustria, Andorra, Bélgica, República Checa, República Dominicana, França, Hungria, Itália, Holanda, Nova Caledónia, República Popular da China, Polónia, Portugal, Principado do Mónaco, República da Irlanda, Reunião, San Marino, Eslováquia, Eslovénia, Espanha, Suíça, Emirados Árabes Unidos, Reino Unido.



## 9803H

bloqueante - força elevada

Apropriado para o bloqueio permanente de partes que não devem ser desmontadas.  
Para a aplicação em superfícies metálicas passivadas como latão, alumínio e aço inox.  
Não permite a desmontagem com ferramentas manuais.



Temperatura de emprego (°C)	-50/+150
Folga diametral (mm)	0,25
Velocidade de reação bloqueio à mão (minutos)	10/15
Endurecimento funcional (horas)	3-6
Viscosidade (mPa.s) 25 °C	800/1200
Binário de desparafusamento INICIAL (ISO-10964)	35-45 Nm
Binário de desaperto RESÍDUO (ISO-10964)	30-40 Nm

ml	€	🔧	📦
20 frasco	13,00	12	098030002
50 frasco	19,80	4	098030005
250 frasco	50,50	4	098030025
20 frasco		12	098032002
50 frasco		4	098032005
250 frasco		4	098032025

## 9802M

bloqueante - força média

Apropriado para fixar e bloquear partes submetidas a manutenção e desmontagens periódicas.  
Permite a desmontagem com o uso de ferramentas manuais.



Temperatura de emprego (°C)	-50/+150
Folga diametral (mm)	0,15
Velocidade de reação bloqueio à mão (minutos)	10/15
Endurecimento funcional (horas)	3-6
Viscosidade (mPa.s) 25 °C	500/800
Binário de desparafusamento INICIAL (ISO-10964)	22-30 Nm
Binário de desaperto RESÍDUO (ISO-10964)	20-25 Nm

ml	€	🔧	📦
20 frasco	13,00	12	098020002
50 frasco	19,80	4	098020005
250 frasco	50,50	4	098020025
20 frasco		12	098022002
50 frasco		4	098022005
250 frasco		4	098022025

## 9801L

bloqueante - força reduzida

Apropriado para bloquear partes em ligas leves que poderão danificar-se durante a desmontagem ou para parafusos de regulação.  
Permite uma fácil desmontagem das partes juntadas.



Temperatura de emprego (°C)	-50/+150
Folga diametral (mm)	0,10
Velocidade de reação bloqueio à mão (minutos)	10/15
Endurecimento funcional (horas)	3-6
Viscosidade (mPa.s) 25 °C	500/800
Binário de desparafusamento INICIAL (ISO-10964)	6-10 Nm
Binário de desaperto RESÍDUO (ISO-10964)	4-8 Nm

ml	€	🔧	📦
20 frasco	13,00	12	098010002
50 frasco	19,80	4	098010005
250 frasco	50,50	4	098010025
20 frasco		12	098012002
50 frasco		4	098012005
250 frasco		4	098012025

## 9813H

vedante de roscas - força elevada

Apropriado para a vedação permanente de conexões com rosca que não devem ser desmontadas.  
Para a aplicação sobre superfícies metálicas passivadas como latão, alumínio e aço inox.  
Não permite a desmontagem com ferramentas manuais.



Temperatura (°C)	-50/+200
Folga diametral (mm)	0,15
Velocidade de reação bloqueio à mão (minutos)	10/15
Endurecimento funcional (horas)	3-6
Viscosidade (mPa.s) 25 °C	40.000/80.000
Binário de desparafusamento INICIAL (ISO-10964)	35-45 Nm
Binário de desaperto RESÍDUO (ISO-10964)	25-35 Nm

ml	€	🔧	📦
20 frasco	11,60	12	098130002
50 frasco de fole	20,30	6	098130305
50 tubo	19,00	4	098130505
250 tubo	47,00	4	098130525
20 frasco		12	098132002
50 frasco de fole		6	098132305
50 tubo		4	098132505
250 tubo		4	098132525

## 9812M

vedante de roscas - força média

Apropriado para vedar conexões com roscas submetidas a manutenção periódica.  
Permite a desmontagem com o uso de ferramentas manuais.



Temperatura (°C)	-50/+150
Folga diametral (mm)	0,35
Velocidade de reação bloqueio à mão (minutos)	12/18
Endurecimento funcional (horas)	3-6
Viscosidade (mPa.s) 25 °C	20.000/40.000
Binário de desparafusamento INICIAL (ISO-10964)	27-35 Nm
Binário de desaperto RESÍDUO (ISO-10964)	20-30 Nm

ml	€	🔧	📦
20 frasco	11,60	12	098120002
50 frasco de fole	20,30	6	098120305
50 tubo	19,00	4	098120505
250 tubo	47,00	4	098120525
20 frasco		12	098122002
50 frasco de fole		6	098122305
50 tubo		4	098122505
250 tubo		4	098122525

## 9811L

vedante de roscas - força reduzida

Apropriado para vedar conexões pequenas ou de passo fino.  
Permite uma fácil desmontagem das partes juntadas.



Temperatura (°C)	-50/+150
Folga diametral (mm)	0,20
Velocidade de reação bloqueio à mão (minutos)	10/15
Endurecimento funcional (horas)	3-6
Viscosidade (mPa.s) 25 °C	10.000/20.000
Binário de desparafusamento INICIAL (ISO-10964)	6-10 Nm
Binário de desaperto RESÍDUO (ISO-10964)	4-8 Nm

ml	€	🔧	📦
20 frasco	11,60	12	098110002
50 frasco de fole	20,30	6	098110305
50 tubo	19,00	4	098110505
250 tubo	47,00	4	098110525
20 frasco		12	098112002
50 frasco de fole		6	098112305
50 tubo		4	098112505
250 tubo		4	098112525

## 9823H

bloqueante líquido - força elevada

Apropriado para vedar superfícies de forma permanente.  
Apropriado também para recompor alojamentos de rolamento ou partes desgastadas.  
Não permite a desmontagem com ferramentas manuais.



Temperatura (°C)	-50/+150
Folga diametral (mm)	0,35
Velocidade de reação	10/16
bloqueio à mão (minutos)	
Endurecimento funcional (horas)	3-6
Viscosidade (mPa.s) 25 °C	100.000/200.000
Binário de desparafusamento INICIAL (ISO-10964)	35-45 Nm
Binário de desaperto RESÍDUO (ISO-10964)	20-30 Nm

ml	€	🔧	📦
20 frasco	11,60	12	098230002
50 frasco de fole	20,30	6	098230305
50 tubo	19,00	4	098230505
250 tubo	47,00	4	098230525
20 frasco		12	098232002
50 frasco de fole		6	098232305
50 tubo		4	098232505
250 tubo		4	098232525

## 9822M

bloqueante líquido - força média

Apropriado para vedar superfícies de partes submetidas a manutenção periódica.  
Permite a desmontagem com o uso de ferramentas manuais.



Temperatura (°C)	-50/+150
Folga diametral (mm)	0,35
Velocidade de reação	10/15
bloqueio à mão (minutos)	
Endurecimento funcional (horas)	3-6
Viscosidade (mPa.s) 25 °C	40.000/70.000
Binário de desparafusamento INICIAL (ISO-10964)	25-35 Nm
Binário de desaperto RESÍDUO (ISO-10964)	20-30 Nm

ml	€	🔧	📦
20 frasco	11,60	12	098220002
50 frasco de fole	20,30	6	098220305
50 tubo	19,00	4	098220505
250 tubo	47,00	4	098220525
20 frasco		12	098222002
50 frasco de fole		6	098222305
50 tubo		4	098222505
250 tubo		4	098222525

## 9821L

bloqueante líquido - força reduzida

Apropriado para vedar superfícies de partes submetidas a manutenção frequente.  
Tolera a ligeira contaminação de óleos.  
Protege as rosças contra corrosão e grimpagens por corrosão.  
Permite uma desmontagem fácil das partes montadas.



Temperatura (°C)	-50/+150
Folga diametral (mm)	0,35
Velocidade de reação	20/30
bloqueio à mão (minutos)	
Endurecimento funcional (horas)	3-6
Viscosidade (mPa.s) 25 °C	60.000/90.000
Binário de desparafusamento INICIAL (ISO-10964)	7-11 Nm
Binário de desaperto RESÍDUO (ISO-10964)	4-9 Nm

ml	€	🔧	📦
20 frasco	11,60	12	098210002
50 frasco de fole	20,30	6	098210305
50 tubo	19,00	4	098210505
250 tubo	47,00	4	098210525
20 frasco		12	098212002
50 frasco de fole		6	098212305
50 tubo		4	098212505
250 tubo		4	098212525

## 9833H

bloqueante - força elevada

Apropriado para a fixação de partes que não devem ser desmontadas.  
Apropriado para fixar dispositivos já instalados e cuja desmontagem é difícil.  
Não permite a desmontagem com ferramentas manuais.



Temperatura (°C)	-50/+180
Folga diametral (mm)	0,15
Velocidade de reação	10/15
bloqueio à mão (minutos)	
Endurecimento funcional (horas)	3-6
Viscosidade (mPa.s) 25 °C	400/700
Binário de desparafusamento INICIAL (ISO-10964)	35-45 Nm
Binário de desaperto RESÍDUO (ISO-10964)	30-40 Nm

ml	€	🔧	📦
20 frasco	12,30	12	098330002
50 frasco	19,00	4	098330005
250 frasco	48,50	4	098330025
20 frasco		12	098332002
50 frasco		4	098332005
250 frasco		4	098332025

## 9832M

bloqueante - força média

Apropriado para a fixação de partes submetidas a manutenção periódica.  
Permite a desmontagem com o uso de ferramentas manuais.



Temperatura (°C)	-50/+180
Folga diametral (mm)	0,25
Velocidade de reação	12/20
bloqueio à mão (minutos)	
Endurecimento funcional (horas)	3-6
Viscosidade (mPa.s) 25 °C	2000/4000
Binário de desparafusamento INICIAL (ISO-10964)	25-35 Nm
Binário de desaperto RESÍDUO (ISO-10964)	18-28 Nm

ml	€	🔧	📦
20 frasco	12,30	12	098320002
50 frasco	19,00	4	098320005
250 frasco	48,50	4	098320025
20 frasco		12	098322002
50 frasco		4	098322005
250 frasco		4	098322025

## 9831L

bloqueante - força reduzida

Apropriado para a fixação de partes submetidas a manutenção frequente e de pequenas dimensões.  
Permite uma desmontagem fácil das partes montadas.



Temperatura (°C)	-50/+150
Folga diametral (mm)	0,10
Velocidade de reação	10/15
bloqueio à mão (minutos)	
Endurecimento funcional (horas)	3-6
Viscosidade (mPa.s) 25 °C	500/800
Binário de desparafusamento INICIAL (ISO-10964)	6-10 Nm
Binário de desaperto RESÍDUO (ISO-10964)	4-8 Nm

ml	€	🔧	📦
20 frasco	12,30	12	098310002
50 frasco	19,00	4	098310005
250 frasco	48,50	4	098310025
20 frasco		12	098312002
50 frasco		4	098312005
250 frasco		4	098312025



## 9840BF - Beta Fix

adesivo de montagem

Adesivo de montagem instantâneo ultrarresistente. Com base no efeito de sucção, os materiais não necessitam de fixação durante o processo de endurecimento. Adere a betão, vidro, gesso cartonado, cerâmica, madeira, metais e plásticos (exceto PE, PP, PC, PMMA, PTFE, plásticos macios e neopreno). Pode ser pintado.

Modo de utilizar: aplicar o adesivo em tiras verticais com 10-20 cm de distância. Posicione o material e pressione com força. Não aplique em pontos. Utilize em superfícies duras isentas de gordura e poeiras. Não exponha à água ou cloretos. Não utilize para mover juntas.



Características:

- Adesão instantânea ultra-forte
- Alta resistência mecânica, força final e módulo elástico
- Livre de isocianatos, ftalatos, solventes e silicone
- Permanentemente elástico, não encolhe, não tem bolhas e é inodoro
- Resistente à humidade e às intempéries
- Adere sem primário à maioria dos substratos, incluindo os húmidos

ml 290 12 098400029

## 9842W - Acryl Seal

selante acrílico

Selante acrílico branco pintável para juntas entre escadas e paredes, tetos, rodapés, parapeitos de janelas, caixilhos de portas e janelas de madeira e metal, betão e alvenaria.

Modo de utilizar: aplicar sobre superfícies duras, secas e isentas de gorduras e poeira. Adere sem primário à maioria das superfícies. Espere até secar completamente antes de pintar, para evitar a formação de fissuras. Compatível com tintas à base de água e sintéticas. Não é adequado para exposição contínua à água.

CE



DoP nr. DOP-9842W  
EN 15651-1: F-EXT-INT

Características:

- Pode ser pintado com tintas à base de água e sintéticas
- Para utilização interna e externa
- Inodoro
- Adere sem primário à maioria das superfícies, fácil de aplicar e limpar

ml 310 12 098420031



## 9843T - Multi Sil

selante de silicone acético multiusos

Selante de silicone acético transparente resistente a mofo, raios UV, água e intempéries. Adere perfeitamente em superfícies de vidro, madeira pintada, cerâmica e esmaltadas.

Modo de utilizar: aplicar sobre superfícies duras, secas e isentas de gordura e poeiras. Adere sem primário à maioria das superfícies. Não pode ser pintado. Não compatível com PE, PP, PC, PMMA, PTFE, plásticos macios, neopreno, substratos betuminosos, betão, mármore, chumbo, cobre e aço galvanizado.

CE



DoP nr. DOP-9843T  
EN 15651-1: F-EXT-INT-CC  
EN 15651-2: G-CC  
EN 15651-3: S (CLASS XS1)

Características:

- Resistente a mofo
- Excelente resistência aos raios UV, água e intempéries
- Permanentemente elástico
- Adere perfeitamente em superfícies de vidro, madeira pintada, cerâmica e esmaltadas

ml 280 12 098430028

## 9844T - Neutral Sil

Selante de silicone neutro transparente

Selante de silicone neutro transparente, resistente ao bolor, aos raios UV, à água e às intempéries. Inodoro. Adequado para vedar casas de banho e cozinhas.

Não está à venda em: Portugal, China, República Checa, Eslovénia, Eslováquia

CE



DoP nr. DOP-9844T  
EN 15651-1: F-EXT-INT-CC (CLASS 12.5E)  
EN 15651-2: G-CC  
EN 15651-3: S (CLASS XS1)

Características:

- Resistente ao bolor
- Resistente aos raios UV, à água e às intempéries
- Inodoro
- Extremamente versátil

ml 310 12 098440031

## 9860 - Multi Foam

espuma de poliuretano

Selante isolante manual de espuma de poliuretano monocomponente. Ideal para fixação de esquadrias e preenchimento de juntas em divisórias, tetos, pisos, penetração superficial de canos e tubagens através de paredes e pisos. Excelente adesão a betão, tijolo, pedra, gesso, madeira, metal e plásticos. Pode ser pintado e rebocado.

Modo de utilizar: retire a tampa e enrosque a cânula na válvula. Agite antes de utilizar pelo menos 20 vezes. Para aplicar a espuma, vire o recipiente de cabeça para baixo e pressione o adaptador. Ao montar caixilhos de janelas, fixe-os durante pelo menos 24 horas. Espere até secar completamente antes de pintar e rebocar. Proteja os olhos durante a utilização; use luvas e equipamento de proteção. Não compatível com PE, PP, PC, PMMA, PTFE, plásticos macios, neopreno e substâncias betuminosas. Não é adequado para exposição contínua à água.



Características:

- Espuma PU profissional de alta qualidade
- Bom desempenho térmico
- Elevada resistência à tensão de tração, compressão e corte

ml 750 12 098600075

## 9841N

Selante de silicone de reticulação acética preta, resistente a altas temperaturas, com prático dispensador de pressão

Suporta temperaturas até 240°C

Permite uma selagem elástica permanente. Substitui as juntas pré-formadas.

O prático doseador permite uma aplicação fácil (com uma camada), precisa e uniforme do produto.

Polimeriza ao reagir com a humidade atmosférica e forma uma junta elástica e duradoura.

Ideal para reservatórios de óleo, bombas de óleo, caixas de velocidades, peças de motor que não estejam sujeitas a alta pressão e aplicações que exijam resistência a altas temperaturas. Adere perfeitamente à maioria dos substratos não porosos, incluindo vidro, madeira revestida, cerâmica e esmalte. Não é adequado para PE, PP, PC, PMMA, PTFE, plásticos moles, neopreno e suportes betuminosos. Não pode ser pintado.

Não disponível para venda nos seguintes países: Portugal, China, Chéquia, Eslovénia e Eslováquia.



ml 200 12 098410120





## 9841R

selante de silicone de reticulação acética vermelha, resistente a altas temperaturas, com prático dispensador de pressão

Suporta temperaturas até 300°C

Permite uma selagem elástica permanente. Substitui as juntas pré-formadas.

O prático doseador permite uma aplicação fácil (com uma camada), precisa e uniforme do produto. Polimeriza ao reagir com a humidade atmosférica e forma uma junta elástica e duradoura.

Ideal para portas de fornos, placas, sistemas de aquecimento, saídas, termostatos, bombas, tubos de aquecimento, peças de motores que não estejam sujeitas a alta pressão e aplicações que exijam resistência a altas temperaturas. Adere perfeitamente à maioria dos substratos não porosos, incluindo vidro, madeira revestida, cerâmica e esmalte. Não é adequado para PE, PP, PC, PMMA, PTFE, plásticos moles, neopreno e suportes betuminosos.

Não pode ser pintado.

Não disponível para venda nos seguintes países: Portugal, China, Chêquia, Eslovénia e Eslováquia.



ml	€	12	98410020
200			

## 9851

cola instantânea para juntas estruturais

Base de etilo cianoacrilato.

Para colar uma ampla gama de materiais, incluindo metal, plástico, couro, madeira e vários outros tipos de substratos, combinados entre si ou separados. Adere rapidamente.

Tubo de 5 g não disponível para venda nos seguintes países: China, Chêquia, Polónia, Eslovénia, Eslováquia



Temperatura (°C)	-55/+82
Viscosidade (mPa.s) 25 °C	80-120

g	€	12	98510500
5 tubo	6,30		
20 frasco	12,30		
50 frasco	23,90		
20 frasco			10 98510005
50 frasco			10 98512002
50 frasco			10 98512005

## 9710 - LUBRIBETA universal

desbloqueador lubrificante multiuso 7 funções

1. Desbloqueante;
  2. Lubrificante;
  3. Detergente;
  4. Protetivo contra ferrugem;
  5. Desoxidante para contactos eléctricos;
  6. À prova de água;
  7. Anticongelante
- Não contém silicone.



ml	€	12	97100040
400			
400	10,30		12 97101040
400			12 97102040

## 9712 - Ultra Sblock

desbloqueador, super-penetrante

Desbloqueante, desoxidante e à prova de água

Apropriado para dissolver a ferrugem de porcas, cavilhas, parafusos e engrenagens.



ml	€	12	97120040
400			
400	7,50		12 97121040
400			12 97122040

## 9720 - Multi Grease

massa lubrificante spray multiuso

Muito indicado para a lubrificação de correntes, engrenagens e partes metálicas em movimento.

Resiste aos atritos e aos agentes atmosféricos. Altamente adesivo. Não pinga.



ml	€	12	97200040
400			
400	8,60		12 97201040
400			12 97202040

## 9722 - Lithium Grease

massa branca spray de lítio

A base de massas saponificadas de lítio, titânio e óxidos de zinco.

Apropriada para engrenagens, rolamentos e rótulas.

Específica para aplicações marítimas.

Bastante resistente à água, salinidade, agentes atmosféricos e altas temperaturas (até 150 °C). Não pinga.



ml	€	12	97220040
400			
400	9,70		12 97221040
400			12 97222040

## 9724 - PTFE Grease

massa spray a base de P.T.F.E.

Especificamente indicado para a lubrificação de correntes industriais e movimentos mecânicos com alta pressão e rotações não elevadas.

Apropriada para aplicações em plástico e borracha.

Totalmente incolor. À prova de água e resistente à oxidação.



ml	€	12	97240040
400			
400	11,10		12 97241040
400			12 97242040

## 9726 - Copper Grease

massa spray com cobre micronizado

Para a lubrificação de rótulas, cavilhas, engrenagens, veios de motor e outras partes metálicas sujeitas a temperaturas elevadas (até 1.000 °C).

Protetivo, anti-desgaste. Previne a oxidação. Não pinga.



ml	€	12	97260040
400			
400	13,00		12 97261040
400			12 97262040

## 9729 - Silic Spray

silicone spray

Apropriado para a lubrificação das partes em plástico, borracha e metais.  
Protege contra a corrosão. Destacante. Anti-estático. À prova de água.  
Abrilhantador para madeira, plástico e borracha. Não contém solventes.



ml	€	🚚	🏠
400		12	097290040
400	7,50	12	097291040
400		12	097292040

## 9738 - Cutting Oil

Óleo de corte

Altamente lubrificante e protetor.  
Adequado para fresagem, mandrilagem, roscagem, perfuração, trabalho manual e automático da máquina.  
Altamente resistente à oxidação  
Lavável com água. Isento de solventes.



ml	€	🚚	🏠
400		12	097380040
400	8,20	12	097381040
400		12	097382040

## 9740 - Brake Cleaner

limpador de travões

Apropriado para a limpeza de discos e pastilhas de travões, motores.  
Elimina massa e alcatrão, sem deixar resíduos.  
Evaporação rápida. Não danifica borracha e plástico.



ml	€	🚚	🏠
500		12	097400050
500	7,40	12	097401050
500		12	097402050

## 9741 - Multi Cleaner

detergente/desengordurante multifunções

Detergente e desengordurante para dissolver gordura, óleo, alcatrão, silicone e cola.  
Adequado para limpeza de metal, plástico duro, cerâmica, superfícies em aço e alumínio. Sem resíduos oleosos.

Não disponível para venda nos seguintes países: China, Chéquia, Polónia, Eslovénia, Eslováquia



ml	€	🚚	🏠
400		12	097410040
400	8,10	12	097411040

## 9742 - Contact Cleaner

limpador para contactos eléctricos e electrónicos

Elimina gordura e sujidade, sem deixar resíduos oleosos.  
Evaporação rápida. Não danifica borracha e plástico.



ml	€	🚚	🏠
400		12	097420040
400	8,10	12	097421040
400		12	097422040

## 9745 - Carb Cleaner

spray para limpeza de carburadores e corpos borboleta

Específico para a limpeza interna e externa de carburadores, tubos de aspiração e corpos borboleta.  
Remove totalmente os resíduos carbonosos, depósitos e impurezas.  
Sem resíduos oleosos.

Não disponível para venda nos seguintes países: China, Chéquia, Polónia, Eslovénia, Eslováquia



ml	€	🚚	🏠
400		12	097450040
400	10,80	12	097451040

## 9746 - Clima Cleaner

spray para limpeza de aparelhos de ar condicionado

Spray para limpeza de aparelhos de ar condicionado industriais, civis e auto. Com a formulação de espuma espessa e a cânula fornecida remove sujidade, depósitos e odores das condutas deixando uma fragância agradável.

Não disponível para venda nos seguintes países: China, Chéquia, Polónia, Eslovénia, Eslováquia



ml	€	🚚	🏠
400		12	097460040
400	13,50	12	097461040

## 9749 - Air Spray

spray de gás comprimido

Spray de gás comprimido. Ideal para remoção de depósitos de poeira de fissuras, engrenagens, peças eléctricas, teclados e mecanismos delicados em geral. A lata de aerosol com cânula permite alcançar peças de difícil acesso.

Não disponível para venda nos seguintes países: Andorra, Emirados Árabes Unidos, República Dominicana, Espanha, Hungria, Portugal, China, Chéquia, Polónia, Eslovénia, Eslováquia



ml	€	🚚	🏠
400		12	097490040



## 9752 - Zinc 98%

zinco claro

Com elevado poder de cobertura, é apropriado para zincar partes em ferro. Altamente adesivo, cria um filme elástico de cor muito clara, semelhante à zincagem a quente. Bastante resistente à oxidação, abrasão e agentes atmosféricos. Pode ser envernizado. Não pinga.



ml	€	12	12
400		097520040	
400	9,40	097521040	
400		097522040	

## 9755 - Welding Spray

spray anti-salpicos de soldadura

Spray anti-salpicos de soldadura. Evita a aderência de escórias, tornando assim a soldadura mais fácil e mais rápida. Para utilização em peças que necessitem de soldadura e como protetor de bicos de tochas de soldadura. Permite realizar operações subsequentes, por ex. pintura, galvanização e cromagem. Sem vapores. Fácil de remover. Sem cloro.

Não disponível para venda nos seguintes países: China, Chéquia, Eslovénia, Eslováquia



ml	€	12	12
400		097550040	
400	8,50	097551040	



## 9765 - Deicer Spray

spray descongelante

Spray descongelante para remover gelo e geada das janelas. Também ideal para fechaduras e mecanismos congelados. Eficaz até -40 ° C.

Não gorduroso, sem manchas. Não afeta superfícies tratadas, borracha e plásticos.

Não disponível para venda nos seguintes países: China, Chéquia, Eslovénia, Eslováquia



ml	€	12	12
400		097650040	
400	14,10	097651040	

## 9775 - Water Stop

spray impermeabilizante de tecido

Spray impermeabilizante e repelente de água para têxteis e couro. Ideal para calçado, casacos e vestuário em geral. Permite impermeabilizar os tecidos, sem afetar a respirabilidade. Graças às suas propriedades de resistência às nódoas, os tecidos são mais fáceis de lavar. Melhora a resistência à deformação e abrasão.

Não disponível para venda nos seguintes países: Andorra, Emiratos Árabes Unidos, República Dominicana, Espanha, Hungria, Portugal, China, Chéquia, Polónia, Eslovénia; Eslováquia



ml	€	12	12
400		097750040	

## 9881U

detergente industrial alcalino para tanque de limpeza com ultrasons

Detergente industrial alcalino, concentrado, à base de água. Para limpeza com ultrasons e outros processos de purificação. Adequado limpeza precisa e eficaz das peças metálicas em geral (injectores, carburadores, válvulas, etc). Remove óleo, gordura, lubrificantes, resíduos de cola, resina e cera. Apropriado também para limpeza de peças em alumínio.



Lt	€	12	12
1	39,50	098810010	
1		098812010	

## 9882R

líquido removedor de ferrugem

removedor de ferrugem líquido à base de álcool para ferro, aço, aço inox, ferro fundido e cromados.

Remove a camada oxidada superior, sem afetar o metal subjacente.

Diluir: de puro a max. 1:1

Temperatura recomendada: 15°C

Tempo de atuação: 30' - 24/48h (para ferrugem pesada)

Biodegradável e 100% solúvel em água.



Lt	€	12	12
1	47,50	098820010	
1		098822010	

# Beta

# Beta





## Beta ABRASIVES

### DISCOS DE CORTE E REBARBAR RÍGIDOS

Os discos rígidos representam a principal categoria desta nova família de produtos, pelo que a Beta Utensili selecionou os melhores materiais.

Os discos de corte e rebarbar são os instrumentos mais rápidos e versáteis para processamento de uma enorme variedade de materiais, utilizando as ferramentas adequadas, quer se trate de rebarbadoras ou máquinas estacionárias.

#### FORMATO DOS DISCOS

 **T42**  
Disco de corte centro côncavo

 **T41**  
Disco de corte centro plano

 **T27**  
Disco de rebarbar centro côncavo

#### CERTIFICAÇÃO



#### TOP — LINE —

Qualidade inquestionável: para utilizadores extremamente exigentes

#### PREMIUM — LINE —

Alta qualidade para alta performance, a preços competitivos, para a melhor relação qualidade/preço.

#### PICTOGRAMAS NOS DISCOS



Utilize óculos de proteção



Utilize protetores auditivos



Utilize máscara anti-poeiras



Utilize luvas de proteção



Utilize vestuário de proteção



Consulte o manual do utilizador



Disco apenas para cortar - não adequado para rebarbar



Não utilize o disco se estiver danificado



Isento de ferro, enxofre e cloro ( $\leq 0.1\%$ )

#### MÓS MONTADAS

Mós montadas para utilização com retificadoras. Disponíveis em vários formatos para se adaptarem a diferentes processos de trabalho, com três tipos de abrasivos.



#### DISCOS LAMELARES

Discos lamelares fabricados em tecido abrasivo colado sobre suporte; são uma excelente opção para operações de desbaste e acabamento. De uma forma geral, garantem uma remoção de material mais rápida, um acabamento mais homogêneo, menor vibração, menos ruído e temperaturas de trabalho menores do que com discos de rebarbar. Disponíveis com tecidos de vários materiais abrasivos, com diferentes tamanhos de grão e dois tipos de suporte.



#### Formatos

##### Plano

Utilização num ângulo máximo de 15° em relação à superfície de trabalho, para processar superfícies planas e arestas.

##### Cônico

Utilização em ângulos entre 15° e 25° em relação à superfície de trabalho, para maior facilidade de processamento de superfícies irregulares. Assegura uma maior superfície de contacto entre o disco e o material. As lamelas podem ser usadas até ao desgaste total.



#### LAMELAS DE LIXA

As lamelas flexíveis permitem um acabamento preciso e homogêneo em formas ou superfícies irregulares.

#### VALIDADE DO PRODUTO

Validade do produto: 3 anos a partir da data de fabrico. A gravação "V01" na anilha metálica no centro do disco indica o trimestre de validade. Exemplo: "V07/2022" indica que o disco foi fabricado no terceiro trimestre de 2023 e pode ser usado até ao fim do 3o trimestre de 2026.



	Trimestre
V01	Jan-Mar
V04	Abr-Jun
V07	Jul-Set
V10	Out-Dez

## 11001

discos abrasivos de corte para aço  
execução com centro deprimido  
A30S EN 12413



A30S



	Ø	S	F	max.	€		
	mm	mm	mm	rpm			
11001	115	3,2	22,23	13300	2,04	10	110010118
11001	125	3,2	22,23	12200	2,16	10	110010128
11001	230	3,2	22,23	6600	4,70	10	110010233

## 11011

discos abrasivos de desbaste para aço  
execução com centro deprimido  
A24N EN 12413



A24N



	Ø	S	F	max.	€		
	mm	mm	mm	rpm			
11011	115	6,5	22,23	13300	2,76	10	110110115
11011	125	6,5	22,23	12200	3,00	10	110110125
11011	230	6,5	22,23	6600	8,70	10	110110230

## 11021

discos abrasivos de corte para aço e inox  
execução com centro deprimido  
A30Q EN 12413



A30Q



	Ø	S	F	max.	€		
	mm	mm	mm	rpm			
11021	115	3,2	22,23	13300	2,04	10	110210118
11021	125	3,2	22,23	12200	2,16	10	110210128
11021	230	3,2	22,23	6600	4,70	10	110210233

## 11023

discos abrasivos de desbaste para aço e inox  
execução com centro deprimido  
A24Q EN 12413



A24Q



	Ø	S	F	max.	€		
	mm	mm	mm	rpm			
11023	115	6,5	22,23	13300	2,76	10	110230115
11023	125	6,5	22,23	12200	3,00	10	110230125
11023	230	6,5	22,23	6600	8,70	10	110230230

## 11034=11038

discos abrasivos de corte para aço e inox  
execução de espessura fina e centro plano

TOP LINE  
Ø 65 mm  
A46U EN 12413



TOP LINE

A46U



	Ø	S	F	max.	€		
	mm	mm	mm	rpm			
11034	115	1,0	22,23	13300	2,64	25	110340022
11034	115	1,6	22,23	13300	2,64	25	110340062

	Ø	S	F	max.	€		
	mm	mm	mm	rpm			
11035	125	1,0	22,23	12200	2,88	25	110350022
11035	125	1,6	22,23	12200	2,88	25	110350062

	Ø	S	F	max.	€		
	mm	mm	mm	rpm			
11038	230	2,0	22,23	6600	5,40	10	110380022





## 11045-11046

discos abrasivos de corte para aço e inox  
execução de espessura fina e centro plano

PREMIUM LINE

Ø 115 mm

A46Q EN 12413

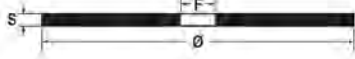

	Ø	S	F	max.	€		
	mm	mm	mm	rpm			
11045	115	1,0	22,23	13300	2,04	25	110450010
11045	115	1,6	22,23	13300	2,04	25	110450016

	Ø	S	F	max.	€		
	mm	mm	mm	rpm			
11046	125	1,0	22,23	12200	2,16	25	110460010
11046	125	1,6	22,23	12200	2,16	25	110460016

## 11049

discos abrasivos de corte para aço e inox  
execução de espessura fina e centro plano

Ø 230 mm

A36Q EN 12413

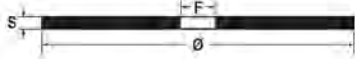

	Ø	S	F	max.	€		
	mm	mm	mm	rpm			
11049	230	2,0	22,23	6600	4,20	10	110490019

## 11101

mós montadas abrasivas  
grãos abrasivos de coríndon rosa  
forma cilíndrica

haste Ø 6 x 40 mm

EN 12413

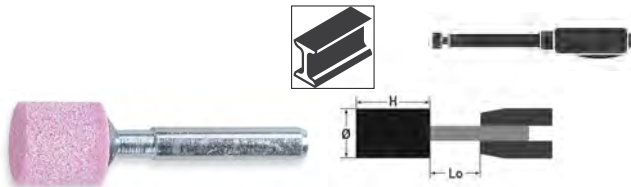

	Ø	h	max. rpm		€		
	mm	mm	Lo=13 mm				
11101	4	8	130.000	AR60P5V	1,36	25	111010004
11101	5	10	130.000	AR60P5V	1,36	25	111010005
11101	6	10	130.00	AR60P5V	1,36	25	111010006
11101	8	10	119.300	AR60P5V	1,36	25	111010008
11101	10	10	95.400	AR60P5V	1,36	25	111010010
11101	10	15	95.400	AR60P5V	1,36	25	111010011
11101	10	20	86.600	AR60P5V	1,48	25	111010012
11101	10	25	72.700	AR60P5V	1,65	25	111010013
11101	10	32	58.700	AR60P5V	1,72	25	111010014
11101	12	20	79.500	AR60P5V	1,41	25	111010017
11101	15	15	63.600	AR60P5V	1,36	25	111010019
11101	16	20	59.600	AR46P5V	1,54	25	111010020
11101	16	25	56.900	AR46P5V	1,65	25	111010021
11101	16	32	45.100	AR46P5V	1,84	25	111010022
11101	20	20	47.700	AR46P5V	1,65	25	111010025
11101	20	25	46.100	AR46P5V	1,72	25	111010026
11101	20	30	38.900	AR46P5V	1,90	25	111010027
11101	20	40	29.00	AR46P5V	2,38	25	111010028
11101	25	25	37.200	AR36/46P5V	1,90	25	111010031
11101	30	30	26.200	AR36/46P5V	2,27	25	111010035
11101	30	40	19.500	AR36/46P5V	3,00	10	111010036
11101	32	32	23.100	AR36P5V	2,90	10	111010038
11101	40	10	23.800	AR36/46P5V	2,27	25	111010041
11101	40	20	23.800	AR36P5V	3,00	10	111010042
11101	40	30	19.700	AR36P5V	3,50	10	111010044
11101	40	40	14.700	AR36P5V	4,20	10	111010045
11101	50	25	18.800	AR36P5V	4,05	10	111010052
11101	60	10	15.900	AR36P5V	3,70	10	111010060

## 11107

mós montadas abrasivas  
grãos abrasivos de coríndon rosa  
forma trapezoidal

haste Ø 6 x 40 mm

EN 12413

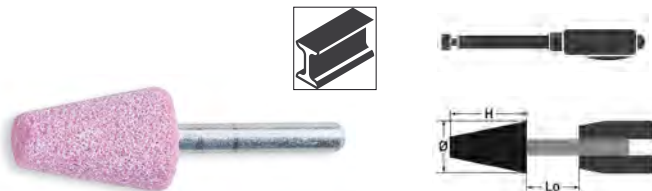

	Ø	h	max. rpm		€		
	mm	mm	Lo=13 mm				
11107	12	20	79.500	AR60P5V	1,72	25	111070012
11107	15	25	60.400	AR46P5V	2,05	25	111070015
11107	20	30	38.900	AR46P5V	2,38	25	111070020
11107	25	40	23.300	AR36/46P5V	3,50	10	111070025





## 11111

mós montadas abrasivas  
grãos abrasivos de coríndon rosa  
forma cônica arredondada

haste Ø 6 x 40 mm

EN 12413

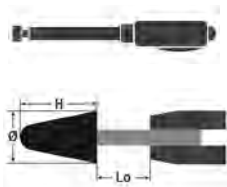

	Ø mm	h mm	max. rpm Lo=13 mm		€		
11111	10	20	86.600	AR60P5V	1,78	25	111110010
11111	15	30	51.000	AR46P5V	2,32	25	111110015
11111	16	45	31.400	AR46P5V	3,15	25	111110016
11111	20	28	41.500	AR46P5V	2,38	25	111110020
11111	20	40	29.000	AR46P5V	3,00	25	111110021
11111	30	50	15.100	AR36/46P5V	4,40	10	111110030

## 11116

mós montadas abrasivas  
grãos abrasivos de coríndon rosa  
forma ogiva

haste Ø 6 x 40 mm

EN 12413

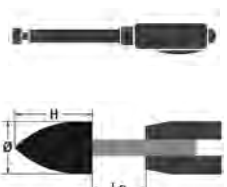

	Ø mm	h mm	max. rpm Lo=13 mm		€		
11116	10	20	86.600	AR60P5V	1,78	25	111160010
11116	18	30	43.000	AR46P5V	2,38	25	111160018
11116	20	50	22.500	AR36/46P5V	3,70	25	111160020

## 11131

mós montadas abrasivas  
grãos abrasivos de coríndon rosa  
forma esférica

haste Ø 6 x 40 mm

EN 12413



	Ø mm	h mm	max. rpm Lo=13 mm		€		
11131	10	10	95.400	AR60P5V	1,65	25	111310010
11131	15	15	63.600	AR60P5V	1,72	25	111310015
11131	20	20	47.700	AR46P5V	2,05	25	111310020
11131	25	25	37.200	AR36/46P5V	2,38	25	111310025
11131	30	30	26.200	AR36/46P5V	2,83	25	111310030

## 1120A-1120B

discos lamelados com tela abrasiva de zircónia  
suporte em plástico e lâmina dupla

Execução plana

PREMIUM LINE

Ø 115 mm

EN 13743

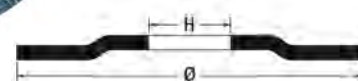
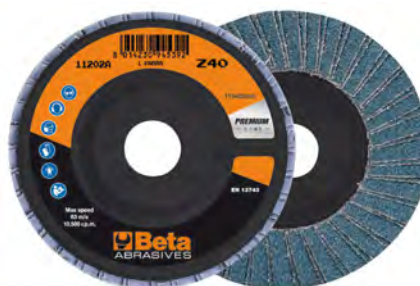

	Ø mm	P	F mm	€		
1120A	115	40	22,23	3,40	10	112020004
1120A	115	60	22,23	3,40	10	112020006
1120A	115	80	22,23	3,40	10	112020008
1120A	115	120	22,23	3,40	10	112020012

	Ø mm	P	F mm	€		
1120B	125	40	22,23	4,10	10	112020104
1120B	125	60	22,23	4,10	10	112020106
1120B	125	80	22,23	4,10	10	112020108

## 1120A-1120B

discos lamelados com tela abrasiva de zircónia  
suporte em fibra de vidro e lâmina simples

Execução plana

PREMIUM LINE

Ø 115 mm

EN 13743

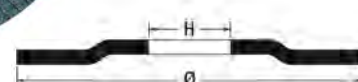

	Ø mm	P	F mm	€		
1120A	115	40	22,23	3,40	10	112040004
1120A	115	60	22,23	3,40	10	112040006
1120A	115	80	22,23	3,40	10	112040008
1120A	115	120	22,23	3,40	10	112040012

	Ø mm	P	F mm	€		
1120B	125	40	22,23	4,10	10	112040104
1120B	125	60	22,23	4,10	10	112040106
1120B	125	80	22,23	4,10	10	112040108

## 11210A-11210B

discos lamelados com tela abrasiva de zircónia  
suporte em fibra de vidro e lâmina simples

Execução cónica  
PREMIUM LINE  
Ø 115 mm  
EN 13743



	Ø mm	P	F mm	€		
11210A	115	40	22,23	3,40	10	112100004
11210A	115	60	22,23	3,40	10	112100006
11210A	115	80	22,23	3,40	10	112100008
11210A	115	120	22,23	3,40	10	112100012

	Ø mm	P	F mm	€		
11210B	125	40	22,23	4,10	10	112100104
11210B	125	60	22,23	4,10	10	112100106
11210B	125	80	22,23	4,10	10	112100108

## 11214A

discos lamelados com tela abrasiva de zircónia  
suporte em plástico e lâmina dupla

Execução plana  
TOP LINE  
Ø 115 mm  
EN 13743

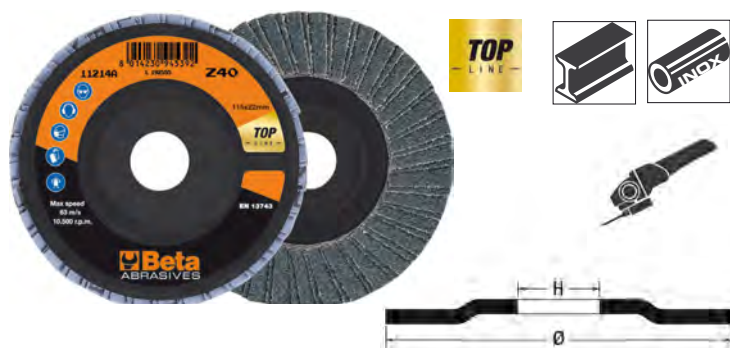

	Ø mm	P	F mm	€		
11214A	115	40	22,23	4,20	10	112140004
11214A	115	60	22,23	4,20	10	112140006
11214A	115	80	22,23	4,20	10	112140008
11214A	115	120	22,23	4,20	10	112140012



## 11216A-11216B

discos lamelados com tela abrasiva de zircónia  
suporte em fibra de vidro e lâmina simples

Execução plana  
TOP LINE  
Ø 115 mm  
EN 13743



	Ø mm	P	F mm	€		
11216A	115	40	22,23	4,20	10	112160004
11216A	115	60	22,23	4,20	10	112160006
11216A	115	80	22,23	4,20	10	112160008
11216A	115	120	22,23	4,20	10	112160012

	Ø mm	P	F mm	€		
11216B	125	40	22,23	5,20	10	112160104
11216B	125	60	22,23	5,20	10	112160106
11216B	125	80	22,23	5,20	10	112160108

## 11234A

discos laminados com tela abrasiva de coríndon  
suporte em fibra de vidro e lâmina simples

Execução plana  
TOP LINE  
Ø 115 mm  
EN 13743



	Ø mm	P	F mm	€		
11234A	115	40	22,23	3,70	10	112340004
11234A	115	60	22,23	3,70	10	112340006
11234A	115	80	22,23	3,70	10	112340008
11234A	115	120	22,23	3,70	10	112340012





## 11246A

discos laminados com tela abrasiva cerâmica  
suporte em plástico e lâmina simples

Execução plana  
Ø 115 mm  
EN 13743



	Ø mm	P	F mm	€		
11246A	115	40	22,23	7,20	10	112460004
11246A	115	60	22,23	7,20	10	112460006

## 11248A

discos laminados com tela abrasiva cerâmica  
suporte em fibra de vidro e lâmina simples

Execução plana  
Ø 115 mm  
EN 13743



	Ø mm	P	F mm	€		
11248A	115	40	22,23	7,20	10	112480004
11248A	115	60	22,23	7,20	10	112480006

## 11259

discos laminados com lâminas em feltro  
suporte em fibra de vidro e lâmina simples

Execução plana



	Ø mm	F mm	€		
11259	115	22,23	11,80	10	112590115

## 11260÷11268

rodas com lâminas com haste  
lâminas em tela abrasiva de coríndon

haste Ø 3 mm  
EN 13743



	Ø mm	h mm	S mm	P	€		
11260	10	10	3	60	5,90	10	112600010
11260	15	15	3	60	4,70	10	112600015

	Ø mm	h mm	S mm	P	€		
11263	30	10	6	60	3,10	10	112630006
11263	30	15	6	60	3,10	10	112630016
11263	30	15	6	80	3,10	10	112630018
11263	30	20	6	40	3,10	10	112630024
11263	30	20	6	60	3,25	10	112630026
11263	30	20	6	80	3,25	10	112630028
11263	30	20	6	120	3,25	10	112630032

	Ø mm	h mm	S mm	P	€		
11264	40	15	6	60	3,40	10	112640006
11264	40	15	6	80	3,40	10	112640008
11264	40	15	6	120	3,40	10	112640012
11264	40	20	6	40	3,50	10	112640014
11264	40	20	6	60	3,50	10	112640016
11264	40	30	6	40	4,00	10	112640024
11264	40	30	6	60	4,00	10	112640026

	Ø mm	h mm	S mm	P	€		
11265	50	20	6	60	4,10	10	112650006
11265	50	20	6	80	4,10	10	112650008
11265	50	30	6	40	4,60	10	112650014
11265	50	30	6	60	4,60	10	112650016
11265	50	30	6	80	4,60	10	112650018
11265	50	30	6	120	4,80	10	112650022

	Ø mm	h mm	S mm	P	€		
11266	60	20	6	60	4,80	10	112660006
11266	60	30	6	40	5,40	10	112660014
11266	60	30	6	60	5,40	10	112660016
11266	60	30	6	80	5,40	10	112660018
11266	60	30	6	120	5,90	10	112660022
11266	60	40	6	60	6,30	10	112660026

	Ø mm	h mm	S mm	P	€		
11268	80	30	6	60	7,50	10	112680006
11268	80	30	6	80	7,50	10	112680008

# Beta





# ALICATES PARA CRAVAGEM DE TERMINAIS

		Terminais	Cavidade do molde	Range (mm <sup>2</sup> )	Utilização
1601/PC					Para terminais telefónicos e de transmissão de dados 4P/6P/8P
1602				0,75-6	Para terminais isolados, série light
1602A				0-6	Para terminais isolados, modelo standard
1603				1,25-5,5	Para terminais não isolados, série light
1603A				0-8	Para terminais não isolados, modelo standard
1603B				0-8	Para terminais abertos não isolados, modelo standard
1606/2				0,14-10	Para trabalhos pesados, terminais cilíndricos
1606A				0,5-6 6-16	Para terminais cilíndricos
1606T				0,1-10	Para terminais cilíndricos, cravagem em 4 lados
1607				6,48 5,41 1,69	Para trabalhos pesados, para cabos coaxiais BNC RG 58, RG 59, RG 62, RG 71
1608				0,5-6	Para terminais isolados, com regulador de pressão
1608A				0,75-6	Para trabalhos pesados, terminais isolados
1609				0,5-2,5	Para terminais não isolados
1609A				0,5-6	Para trabalhos pesados, terminais não isolados
1609B				10-120	Para terminais não isolados

## 1601/PC

alicate para cravar terminais de cabos de telefone e de transmissão de dados



RJ11-RJ12-RJ45 € 74,00 2 016010011

## 1602

alicate para cravar terminais isolados série ligeira

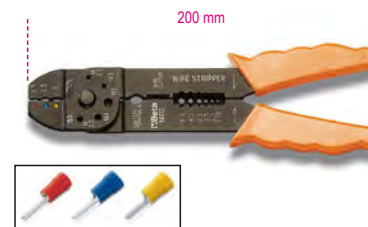

mm<sup>2</sup> € 18,40 5 016020001

## 1602/C9

alicate para cravar terminais isolados série ligeira com jogo de 450 terminais diversos



1602/C9 € 159,00 1 016020045

1602		n.
BM00180	R/6,3	50
BM00280	B/6,3	50
BM00380	G/6,3	50
BM00191	R/6,3	50
BM00291	B/6,3	50
BM00392	G/6,3	50
BM00160	R/1,6	50
BM00260	B/2,3	50
BM00360	G/3,6	50

420x185x60 mm - 1,5 kg



## 1602A

alicate para cravar terminais isolados modelo standard

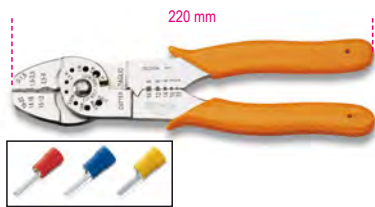

mm<sup>2</sup>  
0÷6 € 67,50 2 016020005

## 1603

alicate para cravar terminais não isolados série ligeira

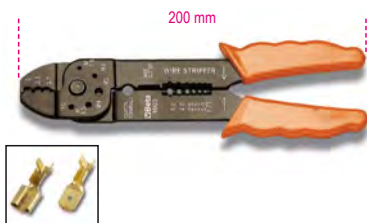

mm<sup>2</sup>  
1,25÷5,5 € 18,40 5 016030001

## 1603A

alicate para cravar terminais não isolados fechados modelo standard

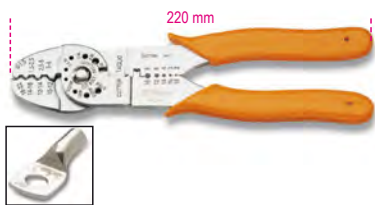

mm<sup>2</sup>  
0÷8 € 67,50 2 016030005

## 1603B

alicate para cravar terminais não isolados abertos modelo standard

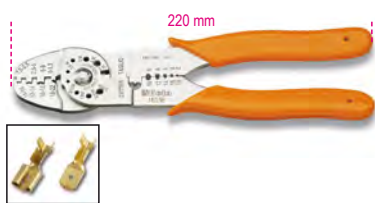

mm<sup>2</sup>  
0÷8 € 69,00 2 016030010



## 1606/2

alicates de cravar terminais cilíndricos para serviços pesados



mm<sup>2</sup> L A B € 0,14÷10 175 65 20 402,00 1 016060002

## 1606A

alicate de cravar terminais tubulares



mm<sup>2</sup> € 1606A6 0,5÷6 108,00 1 016060010  
1606A16 6÷16 108,00 1 016060016

## 1606A/C9

alicate de cravar para terminais tubulares com jogo de 450 terminais, 0,5÷6 mm<sup>2</sup>



1606A/C9 € 176,00 1 016060045

1606A6 n. 1  
BM00601 W/0,5 50  
BM00604 N/1,5 100  
BM00506 B/2,5 100  
BM00508 G/4 100  
BM00610 Y/6 100

420x185x60 mm - 2,5 kg



## 1606T

alicate de cravar terminais tubulares, cravagem em 4 lados

reduzida tensão da alavanca



mm<sup>2</sup> L A B € 0,1÷10 173 61 13 359,00 1 016060005

## 1607

alicates para cravar terminais de cabo coaxial BNC RG 58, RG 59, RG 62, RG 71



1607 L A B € 220 73 19 354,00 1 016070001

## 1608

alicate para cravar terminais isolados, com regulador de pressão



mm<sup>2</sup> € 0,5÷6 138,00 1 016080001



## 1608/C9

alicate de pressão com jogo de 450 terminais diversos



1608/C9 € 279,00 1 016080045

	n.
1608	1
BM00180 R/6,3	50
BM00280 B/6,3	50
BM00380 G/6,3	50
BM00191 R/6,3	50
BM00291 B/6,3	50
BM00392 G/6,3	50
BM00160 R/1,6	50
BM00260 B/2,3	50
BM00360 G/3,6	50
420x185x60 mm - 2 kg	

# Beta

## 1609

alicate para cravar terminais não isolados modelo profissional



mm<sup>2</sup> 0,5÷2,5 € 138,00 1 016090001

## 1609A

alicate para cravar terminais não isolados, para serviço pesado



mm<sup>2</sup> 0,5÷6 € 545,00 1 016090005

## 1609B

alicate de cravar terminais para terminais não isolados

matrizes, 10 mm<sup>2</sup> ÷ 120 mm<sup>2</sup>



L mm 600 mm<sup>2</sup> 10÷120 € 368,00 1 016090101

## 1609C/C5

alicate para cravar terminais hidráulico com 5 pares de matrizes

matrizes hexagonais, 25 mm<sup>2</sup> ÷ 240 mm<sup>2</sup>



mm<sup>2</sup> 50÷240 € 2.360,00 1 016090210  
500x300x110 mm - 4 kg

## 1609M

matrizes para artigo 1609C

matrizes hexagonais



	mm <sup>2</sup>	€		
1609M/16	10-16	85,00	1	016090221
1609M/35	25-35	85,00	1	016090223
1609M/70	50-70	85,00	1	016090225
1609M/120	95-120	85,00	1	016090227
1609M/150	150	85,00	1	016090229
1609M/185	185	85,00	1	016090231
1609M/240	240	85,00	1	016090233

## 1639S

extractor fios de nylon

com cabeças intercambiáveis



L m 10 Ø mm 4 € 24,10 1 016390010







# PRODUTOS DA MARCA BM

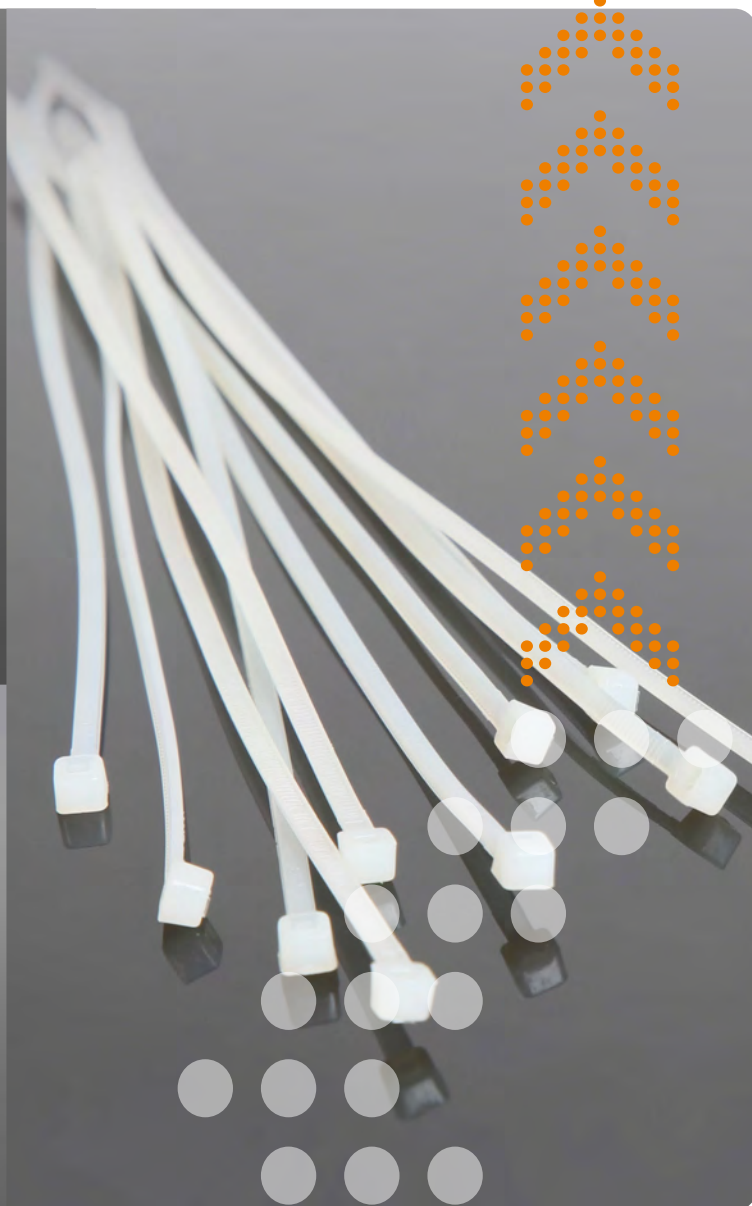
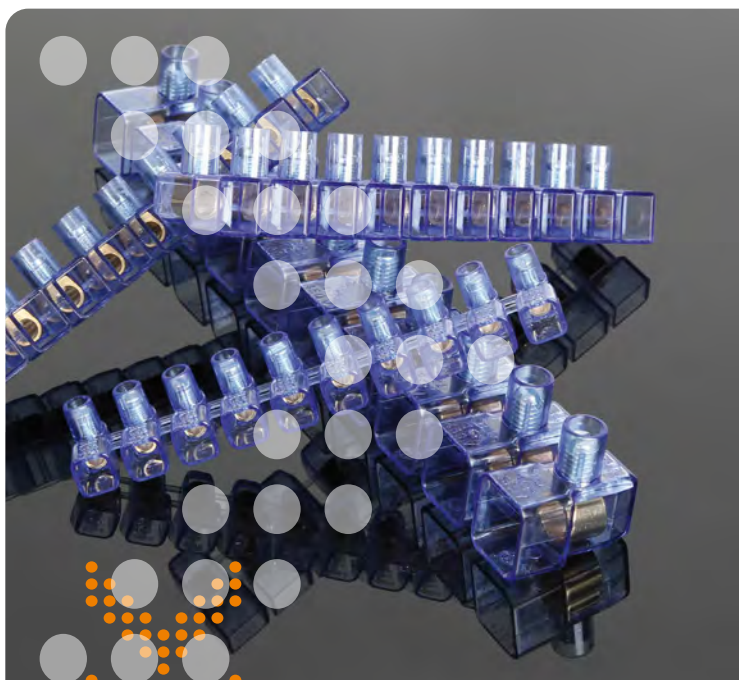

## PRODUTOS DA MARCA BM: TERMINAIS, ABRAÇADEIRAS, BLOCOS DE TERMINAIS, FITAS ISOLADORAS

O Grupo BM concebe, fabrica e distribui peças de ligação e produtos de instalação elétrica desde 1958.

Qualidade, segurança e fiabilidade sempre foram os principais valores da BM. Combinados com a paixão pela excelência, estes valores permitiram que a empresa se tornasse numa referência para o mercado de materiais elétricos.

Em 2018, o Grupo BM foi integrado pela Beta Utensili. Esta seção inclui uma seleção de produtos da marca BM, complementando a linha de produtos Beta.

## QUALIDADE CERTIFICADA





## 1610-B terminais pré-isolados com olhais

D mm	mm <sup>2</sup>	L mm	€	100	BM00119
4	0,25-1,5	20,6	9,30	100	BM00119
5	0,25-1,5	21,8	10,90	100	BM00125
5	1,5-2,5	22,4	11,50	100	BM00225
6	1,5-2,5	26	10,50	100	BM00231
8	1,5-2,5	29,8	16,40	100	BM00237
6	4-6	29,1	22,90	50	BM00331
8	4-6	34,5	20,20	50	BM00337

indicar no pedido o número de terminais e não de embalagens

-os preços indicados são relativos a 100 unidades

## 1614-P terminais pré-isolados com ponta

D mm	mm <sup>2</sup>	L mm	€	100	BM00151
1,9	0,25-1,5	19	9,30	100	BM00151
1,9	1,5-2,5	19	13,10	100	BM00251
2,7	4-6	28	20,80	50	BM00350

indicar no pedido o número de terminais e não de embalagens

-os preços indicados são relativos a 100 unidades

## 1616-SM terminais pré-isolados tipo pino macho

D mm	mm <sup>2</sup>	L mm	€	100	BM00130
4	0,25-1,5	21	18,30	100	BM00130

indicar no pedido o número de terminais e não de embalagens

-os preços indicados são relativos a 100 unidades

## 1618-SF terminais pré-isolados tipo pino fêmea

D mm	mm <sup>2</sup>	L mm	€	100	BM00140
3,8	0,25-1,5	23,5	21,20	100	BM00140

indicar no pedido o número de terminais e não de embalagens

-os preços indicados são relativos a 100 unidades

## 1620-M terminais pré-isolados rápidos macho

HxS mm	mm <sup>2</sup>	L mm	€	100	BM00180
6,3x0,8	0,25-1,5	21	17,60	100	BM00180
6,3x0,8	1,5-2,5	21	18,30	100	BM00280
6,3x0,8	4-6	24,5	20,00	50	BM00380

indicar no pedido o número de terminais e não de embalagens

-os preços indicados são relativos a 100 unidades

## 1622-F terminais pré-isolados rápidos fêmea

HxS mm	mm <sup>2</sup>	L mm	€	100	BM00190
6,3x0,8	0,25-1,5	20,7	17,90	100	BM00190
2,8x0,5	0,25-1,5	18,5	15,10	100	BM00395
6,3x0,8	1,5-2,5	20,7	18,30	100	BM00290
6,3x0,8	4-6	24,5	26,00	50	BM00391

indicar no pedido o número de terminais e não de embalagens

-os preços indicados são relativos a 100 unidades

## 1624-FI terminais rápidos fêmea isolados

HxS mm	mm <sup>2</sup>	L mm	€	100	BM00191
6,3x0,8	0,25-1,5	22	19,80	100	BM00191
6,3x0,8	1,5-2,5	22	20,10	50	BM00291
6,3x0,8	4-6	25	25,00	50	BM00392

indicar no pedido o número de terminais e não de embalagens

-os preços indicados são relativos a 100 unidades

## 1628-C conectores de linha pré-isolados

D mm	mm <sup>2</sup>	L mm	€	100	BM00160
1,8	0,25-1,5	25	14,90	100	BM00160
2,5	1,5-2,5	26,5	17,60	100	BM00260
3,7	4-6	27	24,40	50	BM00360

indicar no pedido o número de terminais e não de embalagens

-os preços indicados são relativos a 100 unidades

## 1630-CR conectores rápidos

mm <sup>2</sup>	L mm	€	500	BM00110
0,25-1	15,3	15,40	500	BM00110
1,25-2,5	15,9	15,00	500	BM00210

indicar no pedido o número de terminais e não de embalagens

-os preços indicados são relativos a 100 unidades

## 1632-TS terminais tipo tubo simples

mm <sup>2</sup>	L mm	€	500	BM00601
0,5	14	1,83	500	BM00601
0,75	14	1,83	500	BM00602
1	14	1,83	500	BM00603
1,5	14	1,83	500	BM00604
2,5	14	2,40	250	BM00506
4	17	3,80	200	BM00508
6	20	6,20	100	BM00610
0,5	14	1,75	500	BM00501
0,75	14	1,75	500	BM00502
1	14	1,75	500	BM00503
1,5	14	1,74	500	BM00504
6	20	5,90	100	BM00510

indicar no pedido o número de terminais e não de embalagens

-os preços indicados são relativos a 100 unidades

## 1634-TD terminais tipo tubo duplos

mm <sup>2</sup>	L mm	€	200	BM00651
2x0,5	15	6,10	200	BM00651
2x0,75	15	4,70	200	BM00652
2x1	15	4,70	200	BM00654
2x1,5	16	5,10	200	BM00656
2x2,5	18,5	5,80	100	BM00558
2x4	23	17,10	100	BM00560
2x6	26	22,30	50	BM00661
2X0,5	15	4,50	200	BM00551
2X0,75	15	4,50	200	BM00552
2X1	15	4,50	200	BM00554
2X1,5	16	4,80	200	BM00556
2X6	26	21,20	50	BM00561

indicar no pedido o número de terminais e não de embalagens

-os preços indicados são relativos a 100 unidades







## 1635-D

terminais de polipropileno, réguas de 12 polos

Corpo isolante: polipropileno natural (PP)  
 Corpo condutor: latão  
 Parafuso imperdível: aço zincado  
 Auto-extinção: EN 60335-1: 2002+A2:2006 (par. 30.2.3), EN 60695-2-10 a 850 °C, EN 60695-2-11  
 Temperatura de funcionamento: máx. 85°C  
 Grau de proteção: IP20  
 Normas de referência: EN 60998-1: 2004, EN 60998-2-1: 2004, EN 60335-1: 2002 + A2: 2006 (par. 30.2.3), IEC/EN 60695-2-11



mm²	L mm	L1 mm	mm²	€	🔧	📦
16	93,7	14,7	2,5	1,56	50	BM9200
20,5	116,5	17,2	4	1,93	50	BM9201
23,5	139,5	20,1	6	2,81	50	BM9202
25,3	175,5	22,5	16	4,95	25	BM9203
35,2	228	33,5	25	13,70	10	BM9204

## 1635-S

cerra-cabos terminais para ligações avulsas

Corpo isolante: policarbonato transparente UL94 V0  
 Corpo condutor: latão  
 Parafuso imperdível: aço zincado  
 Auto-extinção: EN60695-2-10 a 850 °C, EN 60335-1:2002 +A2:2006, EN60695-2-11  
 Temperatura de operação: max 85 °C  
 Grau de proteção: IP20  
 Normas de referência: EN60998-1: EN60998-2-1:2004



mm²	L mm	L1 mm	S mm	mm²	N	€	🔧	📦
1.5	15	7.5	14.5	1.5	2	1,41	10	BM991
				1 2÷3	0.75 2÷4			
				2.5	2			
2.5	17.5	9	18.2	2.5	2	1,44	10	BM992
				1.5 2÷3	1 2÷4			
				4	2			
4	21	10.3	20	4	2	1,93	10	BM9924
				2.5 2÷3	1.5 2÷4			
				6	2			
6	22.5	11.8	23	6	2	2,25	10	BM993
				4 2÷3	2.5 2÷4			
				10	2			
10	26	14.7	26	10	2	5,50	10	BM994
				6 2÷3	4 2÷4			
				16	2			
16	31.8	18.8	32.2	16	2	12,00	10	BM995
				10 2÷3	6 2÷4			

## 1635-S



mm²	L mm	L1 mm	S mm	mm²	N	€	🔧	📦
25	36.3	22.5	41.9	25	2	4,20	25	BM9960
				16 2÷3	10 2÷4			
				35	2			
35	43.5	26.1	49.4	35	2	5,40	25	BM9961
				25 2÷3	16 2÷4			



## 1748-BV2

abraçadeiras em nylon, cor natural

Material: Poliamida PA 6.6  
 Classe de auto-extinção: UL 94-V2  
 Temperatura de operação: -40 °C + +85 °C  
 Temperatura mínima de instalação: -10 °C  
 Resistência aos agentes químicos: Boa resistência às bases, aos óleos, às massas, aos solventes de cloreto. Limitada resistência aos ácidos. Não resistente aos fenóis  
 Normas de referência: EN 62275:2015-02  
 Classificação: tipo 1 (EN); tipo 21 (UL)



A mm	L mm	Ø MAX mm	F MAX N	€	🔧	📦
2.5	80	14	80	1,54	100	BMB0824
2.5	100	20.5	80	1,43	100	BMB1025
2.5	120	27	80	2,51	100	BMB1225
2.5	160	40	80	3,40	100	BMB1625
2.5	200	52.5	80	3,70	100	BMB2025
3.6	140	33	180	3,80	100	BMB1436
3.6	200	52.5	180	5,30	100	BMB2036
3.6	300	106	180	7,40	100	BMB2936
3.6	370	105	180	11,70	100	BMB3736
4.6	120	24	220	5,20	100	BMB1248
4.6	160	36	220	5,50	100	BMB1648
4.8	188	46	220	6,60	100	BMB1948
4.8	200	50	220	6,50	100	BMB2048
4.8	250	65	220	9,40	100	BMB2548
4.8	300	81	220	9,60	100	BMB3048
4.8	370	103.5	220	12,10	100	BMB3748
4.8	390	110	220	16,50	100	BMB3948
4.8	430	122.5	220	21,30	100	BMB4348
4.8	530	160	220	35,50	100	BMB5348
7.6	150	24	550	17,60	100	BMB1576
7.6	200	51	550	18,10	100	BMB2076
7.6	300	83	550	20,20	100	BMB2976
7.6	370	103.5	550	24,50	100	BMB3776
7.6	450	130.5	550	41,50	100	BMB4576
7.6	540	159	550	53,50	100	BMB5476
7.6	750	226	550	85,50	100	BMB7576
8.8	550	163.5	800	50,50	100	BMB5390
8.8	710	195	800	71,00	100	BMB7190
8.8	780	235.5	800	79,50	100	BMB7890
9.0	430	130.5	800	42,00	100	BMB4390
9.0	810	245	800	94,50	100	BMB8190
9.0	1020	295	800	130,00	100	BMB1090
9.0	1220	375.5	800	169,00	100	BMB1290
9.0	1530	460	800	230,00	100	BMB1590

indicar no pedido o número de terminais e não de embalagens

-os preços indicados são relativos a 100 unidades



## 1748V

abraçadeiras em nylon, cor verde

Material: poliamida PA 6.6  
 Classe de auto-extinção: UL 94-V2  
 Temperatura de funcionamento: -40 °C + +85 °C  
 Temperatura mínima de instalação: -10 °C  
 Resistência a produtos químicos: boa resistência a bases, óleos, graxas, solventes de cloreto. Resistência limitada a ácidos. Não resistente a fenóis.  
 Normas de referência: EN 62275:2015-02  
 Classificação: tipo 1 (EN); tipo 21 (UL)



A mm	L mm	Ø MAX mm	F MAX N	€	🔧	📦
2.5	100	20.5	80	1,41	100	BMV1025
3.6	140	33	180	3,45	100	BMV1436
4.8	200	50	220	5,90	100	BMV2048
4.8	300	81	220	8,70	100	BMV3048

- Por favor, indique o número de abraçadeiras, e não de embalagens no seu pedido.

- Os preços indicados são para 100 unid.

## 1748N

abraçadeiras em nylon, cor preta

resistente a UV

Material: Poliamida PA 6.6 + carbon black  
 Classe de auto-extinção: UL 94-V2  
 Temperatura de operação: -40 °C + +85 °C  
 Temperatura mínima de instalação: -10°C  
 Resistência aos agentes químicos: Boa resistência às bases, aos óleos, às massas, aos solventes de cloreto. Limitada resistência aos ácidos. Não resistente aos fenóis  
 Normas de referência: EN 62275:2015-02  
 Classificação: tipo 1 (EN)



A mm	L mm	Ø mm	F MAX N	€	🔧	📦
2.5	80	14	80	1,54	100	BMN0824
2.5	100	20.5	80	1,43	100	BMN1025
2.5	120	27	80	2,54	100	BMN1225
2.5	160	40	80	3,40	100	BMN1625
2.5	200	52.5	80	3,70	100	BMN2025
3.6	140	33	180	3,80	100	BMN1436
3.6	200	52.5	180	5,30	100	BMN2036
3.6	300	106	180	7,40	100	BMN2936
3.6	370	105	180	11,90	100	BMN3736
4.6	120	24	220	5,20	100	BMN1248
4.6	160	36	220	5,60	100	BMN1648
4.8	188	46	220	6,60	100	BMN1948
4.8	200	50	220	6,50	100	BMN2048
4.8	250	65	220	9,40	100	BMN2548
4.8	300	81	220	9,60	100	BMN3048
4.8	370	103.5	220	12,10	100	BMN3748
4.8	390	110	220	16,50	100	BMN3948
4.8	430	122.5	220	21,30	100	BMN4348
4.8	530	160	220	35,50	100	BMN5348
7.6	150	24	550	17,60	100	BMN1576
7.6	200	51	550	18,10	100	BMN2076
7.6	300	83	550	20,20	100	BMN2976
7.6	370	103.5	550	24,00	100	BMN3776
7.6	450	130.5	550	41,50	100	BMN4576
7.6	540	159	550	53,50	100	BMN5476
7.6	750	226	550	85,50	100	BMN7576
8.8	550	163.5	800	50,50	100	BMN5390
8.8	710	195	800	71,00	100	BMN7190
8.8	780	235.5	800	79,50	100	BMN7890
9.0	430	130.5	800	42,00	100	BMN4390
9.0	810	245	800	94,00	100	BMN8190
9.0	1020	295	800	131,00	100	BMN1090
9.0	1220	375.5	800	169,00	100	BMN1290
9.0	1530	460	800	230,00	100	BMN1590

A mm	L mm	Ø mm	F MAX N	€	🔧	📦
2.5	80	14	80	1,54	100	BMN0824
2.5	100	20.5	80	1,43	100	BMN1025
2.5	120	27	80	2,54	100	BMN1225
2.5	160	40	80	3,40	100	BMN1625
2.5	200	52.5	80	3,70	100	BMN2025
3.6	140	33	180	3,80	100	BMN1436
3.6	200	52.5	180	5,30	100	BMN2036
3.6	300	106	180	7,40	100	BMN2936
3.6	370	105	180	11,90	100	BMN3736
4.6	120	24	220	5,20	100	BMN1248
4.6	160	36	220	5,60	100	BMN1648
4.8	188	46	220	6,60	100	BMN1948
4.8	200	50	220	6,50	100	BMN2048
4.8	250	65	220	9,40	100	BMN2548
4.8	300	81	220	9,60	100	BMN3048
4.8	370	103.5	220	12,10	100	BMN3748
4.8	390	110	220	16,50	100	BMN3948
4.8	430	122.5	220	21,30	100	BMN4348
4.8	530	160	220	35,50	100	BMN5348
7.6	150	24	550	17,60	100	BMN1576
7.6	200	51	550	18,10	100	BMN2076
7.6	300	83	550	20,20	100	BMN2976
7.6	370	103.5	550	24,00	100	BMN3776
7.6	450	130.5	550	41,50	100	BMN4576
7.6	540	159	550	53,50	100	BMN5476
7.6	750	226	550	85,50	100	BMN7576
8.8	550	163.5	800	50,50	100	BMN5390
8.8	710	195	800	71,00	100	BMN7190
8.8	780	235.5	800	79,50		



## 1748-UL

abraçadeiras em nylon,  
cor preta  
resistente a UV

CE

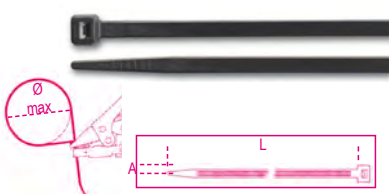

A	L	Ø MAX	F MAX	€		
mm	mm	mm	N			
12.4	230	57	1200	52,00	100	BMN2412
12.4	480	136.5	1200	89,50	100	BMN4912
12.4	730	216.1	1200	125,00	100	BMN7412
12.4	880	263.9	1200	149,00	100	BMN8912
12.4	1000	305	1200	178,00	100	BMN1012

## 1748-N2D

abraçadeiras em nylon,  
cor preta  
resistente a UV

Material: poliamida PA 6.6 + carbon black  
Classe de auto-extinção: UL 94-V2  
Temperatura de operação: -40 °C + +85 °C  
Temperatura mínima de instalação: -10 °C  
Resistência aos agentes químicos: Boa resistência às bases, aos óleos, às massas, aos solventes de cloreto. Limitada resistência aos ácidos. Não resistente aos fenóis  
Normas de referência: EN 62275:2015-02  
Classificação: tipo 1 (EN)

CE



A	L	Ø MAX	F MAX	€		
mm	mm	mm	N			
9.0	180	40	400	27,00	100	BMN1890
9.0	265	62	540	42,00	100	BMN2690
9.0	360	93	540	51,00	100	BMN3690

- No pedido indicar o número de abraçadeiras e não de embalagens  
- Os valores indicados são para 100 unidades



## 1748-BVO

abraçadeiras em nylon auto-extinguente,  
cor branca

Material: Poliamida PA 6.6  
Classe de auto-extinção: UL 94-V0  
Temperatura de operação: -40 °C + +8 °C  
Temperatura mínima de instalação: -10 °C  
Resistência aos agentes químicos: Boa resistência às bases, aos óleos, às massas, aos solventes de cloreto. Limitada resistência aos ácidos. Não resistente aos fenóis  
Normas de referência: EN 62275:2015-02  
Classificação: tipo 1 (EN)

CE V0

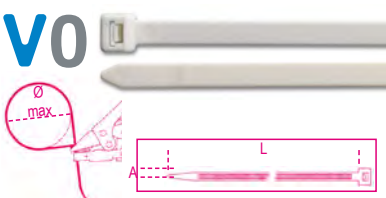

A	L	Ø MAX	F MAX	€		
mm	mm	mm	N			
2.5	100	20.5	80	2,23	100	BMB1025V0
3.6	150	36.0	180	5,40	100	BMB1536V0
3.6	200	52.5	180	7,80	100	BMB2036V0
4.8	200	49.5	230	8,50	100	BMB2048V0
4.8	300	81.0	230	12,40	100	BMB3048V0
4.8	370	106.7	230	17,70	100	BMB3848V0
7.6	370	106.7	540	31,00	100	BMB3876V0

indicar no pedido o número de terminais e não de embalagens

-os preços indicados são relativos a 100 unidades

## 1748-BX

abraçadeiras em nylon,  
cor azul,  
detectável por detector de metais

Material: Poliamida PA 6.6 + pó metálico  
Classe de auto-extinção: UL 94-V2  
Temperatura de operação: -40 °C + +85 °C  
Temperatura mínima de instalação: -10 °C  
Resistência aos agentes químicos: Boa resistência às bases, aos óleos, às massas, aos solventes de cloreto. Limitada resistência aos ácidos. Não resistente aos fenóis  
Normas de referência: EN 62275:2015-02  
Classificação: tipo 1 (EN)

CE

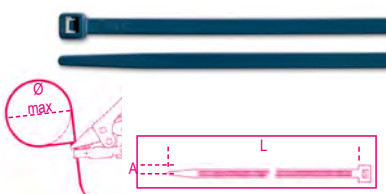

A	L	Ø MAX	F MAX	€		
mm	mm	mm	N			
2.5	100	20.5	80	2,68	100	BMBX1025
3.6	150	36.0	180	7,10	100	BMBX1536
3.6	200	52.5	180	9,50	100	BMBX2036
4.8	200	49.5	230	11,60	100	BMBX2048
4.8	300	81.0	230	16,80	100	BMBX3048
4.8	370	106.7	230	22,80	100	BMBX3848
7.6	370	106.7	540	41,50	100	BMBX3876

## 1748-BL

abraçadeiras em nylon com dente em aço,  
cor natural

Material: Poliamida PA 6.6 + aço  
Classe de auto-extinção: UL 94-V2  
Temperatura de operação: -40 °C + +85 °C  
Temperatura mínima de instalação: -10 °C  
Resistência aos agentes químicos: Boa resistência às bases, aos óleos, às massas, aos solventes de cloreto. Limitada resistência aos ácidos. Não resistente aos fenóis  
Normas de referência: EN 62275:2015-02  
Classificação: tipo 1 (EN)

CE

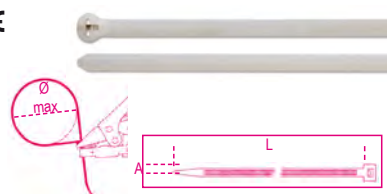

A	L	Ø MAX	F MAX	€		
mm	mm	mm	N			
2.5	100	20.5	180	5,40	100	BMBL1025
2.5	200	52.5	180	7,00	100	BMBL2025
3.6	140	33.0	250	12,00	100	BMBL1436
4.8	200	49.5	360	16,70	100	BMBL2048
4.8	300	81.0	360	21,40	100	BMBL3048
4.8	370	103.5	360	25,50	100	BMBL3748
7.6	370	103.5	780	48,50	100	BMBL3776

indicar no pedido o número de terminais e não de embalagens

-os preços indicados são relativos a 100 unidades

## 1748-NL

abraçadeiras em nylon com dente de aço,  
cor preta,  
resistente a UV

Material: Poliamida PA 6.6 + aço + carbon black  
Classe de auto-extinção: UL 94-V2  
Temperatura de operação: -40 °C + +85 °C  
Temperatura mínima de instalação: -10 °C  
Resistência aos agentes químicos: Boa resistência às bases, aos óleos, às massas, aos solventes de cloreto. Limitada resistência aos ácidos. Não resistente aos fenóis  
Normas de referência: EN 62275:2015-02  
Classificação: tipo 1 (EN)

CE

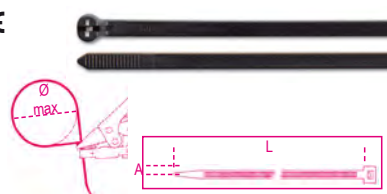

A	L	Ø MAX	F MAX	€		
mm	mm	mm	N			
2.5	100	20.5	180	5,40	100	BMNL1025
2.5	200	52.5	180	7,00	100	BMNL2025
3.6	140	33.0	250	12,00	100	BMNL1436
4.8	200	49.5	360	16,70	100	BMNL2048
4.8	300	81.0	360	21,40	100	BMNL3048
4.8	370	103.5	360	25,50	100	BMNL3748
7.6	370	103.5	780	47,50	100	BMNL3776

indicar no pedido o número de terminais e não de embalagens

-os preços indicados são relativos a 100 unidades



## 1748-BR

abraçadeiras em nylon reutilizáveis,  
cor natural

Material: Poliamida PA 6.6  
Classe de auto-extinção: UL 94-V2  
Temperatura de operação: -40 °C + +85 °C  
Temperatura mínima de instalação: -10 °C  
Resistência aos agentes químicos: Boa resistência às bases, aos óleos, às massas, aos solventes de cloreto. Limitada resistência aos ácidos. Não resistente aos fenóis  
Normas de referência: EN 62275:2015-02  
Classificação: tipo 1 (EN); tipo 21 (UL)

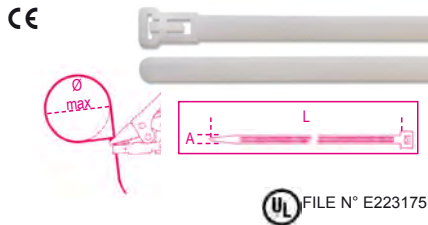

A	L	Ø MAX	F MAX	€	100	BMBR
mm	mm	mm	N			
7.6	150	40	230	18,50	100	BMBR1576
7.6	200	55	230	19,80	100	BMBR2076
7.6	300	82	230	33,50	100	BMBR3076

## 1748-BH

abraçadeiras em nylon com olhal,  
cor natural

Material: Poliamida PA 6.6  
Classe de auto-extinção: UL 94-V2  
Temperatura de operação: -40 °C + +85 °C  
Temperatura mínima de instalação: -10 °C  
Resistência aos agentes químicos: Boa resistência às bases, aos óleos, às massas, aos solventes de cloreto. Limitada resistência aos ácidos. Não resistente aos fenóis  
Normas de referência: EN 62275:2015-02  
Classificação: tipo 1 (EN); tipo 21 (UL)

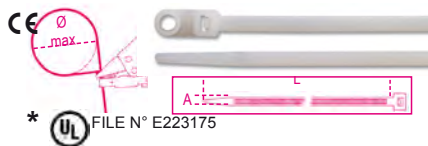

A	L	Ø MAX	F MAX	€	100	BMBH
mm	mm	mm	N			
2.5	110	19.0	80	4,90	100	BMBH1125
* 4.8	200	49.8	230	12,10	100	BMBH2048
* 7.6	305	78.7	550	40,00	100	BMBH3076

## 1748-BP

abraçadeiras em nylon de inserção,  
cor natural

Material: Poliamida PA 6.6  
Classe de auto-extinção: UL 94-V2  
Temperatura de operação: -40 °C + +85 °C  
Temperatura mínima de instalação: -10 °C  
Resistência aos agentes químicos: Boa resistência às bases, aos óleos, às massas, aos solventes de cloreto. Limitada resistência aos ácidos. Não resistente aos fenóis  
Normas de referência: EN 62275:2015-02  
Classificação: tipo 1 (EN); tipo 21 (UL)

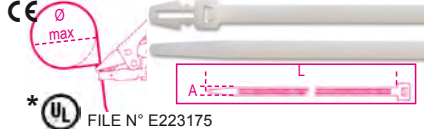

A	L	Ø MAX	F MAX	€	100	BMBP
mm	mm	mm	N			
3.6	155	37.9	180	7,50	100	BMBP1536
* 4.8	200	50.8	230	13,00	100	BMBP2048

## 1748-BT

abraçadeiras em nylon com etiqueta  
transversal 25x8mm,  
cor natural

Material: Poliamida PA 6.6  
Classe de auto-extinção: UL 94-V2  
Temperatura de operação: -40 °C + +85 °C  
Temperatura mínima de instalação: -10 °C  
Resistência aos agentes químicos: Boa resistência às bases, aos óleos, às massas, aos solventes de cloreto. Limitada resistência aos ácidos. Não resistente aos fenóis  
Normas de referência: EN 62275:2015-02  
Classificação: tipo 1 (EN); tipo 21 (UL)

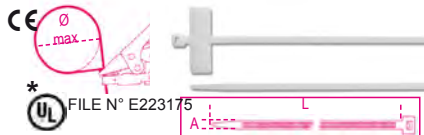

A	L	Ø MAX	F MAX	€	100	BMBT
mm	mm	mm	N			
* 2.5	100	22.0	80	8,40	100	BMBT21025
2.5	200	53.5	80	13,20	100	BMBT22025

indicar no pedido o número de terminais e não de embalagens

-os preços indicados são relativos a 100 unidades

## 1748-BT2

abraçadeiras em nylon com etiqueta  
longitudinal 13x27mm,  
cor natural

Material: Poliamida PA 6.6  
Classe de auto-extinção: UL 94-V2  
Temperatura de operação: -40 °C + +85 °C  
Temperatura mínima de instalação: -10 °C  
Resistência aos agentes químicos: Boa resistência às bases, aos óleos, às massas, aos solventes de cloreto. Limitada resistência aos ácidos. Não resistente aos fenóis  
Normas de referência: EN 62275:2015-02  
Classificação: tipo 1 (EN)

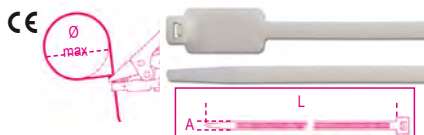

A	L	Ø MAX	F MAX	€	100	BMBT
mm	mm	mm	N			
4.8	190	51	230	15,60	100	BMBT12248

## 1748-BT3

abraçadeiras em nylon com etiqueta externa  
20x9mm,  
cor natural

Material: Poliamida PA 6.6  
Classe de auto-extinção: UL 94-V2  
Temperatura de operação: -40 °C + +85 °C  
Temperatura mínima de instalação: -10 °C  
Resistência aos agentes químicos: Boa resistência às bases, aos óleos, às massas, aos solventes de cloreto. Limitada resistência aos ácidos. Não resistente aos fenóis  
Normas de referência: EN 62275:2015-02  
Classificação: tipo 1 (EN)

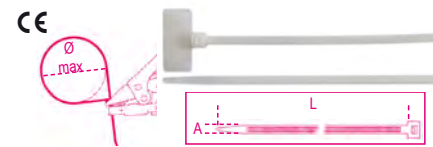

A	L	Ø MAX	F MAX	€	100	BMBT
mm	mm	mm	N			
2.5	110	22	80	8,60	100	BMBT11125

indicar no pedido o número de terminais e não de embalagens

-os preços indicados são relativos a 100 unidades

## 1748-BA1

suportes de fixação

Material: Poliamida PA 6.6  
Classe de auto-extinção: UL 94-V2  
Temperatura de operação: -40 °C + +85 °C  
Temperatura mínima de instalação: -10 °C  
Resistência aos agentes químicos: Boa resistência às bases, aos óleos, às massas, aos solventes de cloreto. Resistência limitada aos ácidos. Não resistente aos fenóis



SxDxH	Ø	F	€	100	BMB
mm	mm	mm			
15.2x9.4x6.8	3.3	3.6	11,70	100	BMB0905
22x16.2x10.8	5.2	9	26,50	100	BMB0906

indicar no pedido o número de terminais e não de embalagens

-os preços indicados são relativos a 100 unidades

## 1748-NA1

suportes de fixação

Material: Poliamida PA 6.6  
Classe de auto-extinção: UL 94-V2  
Temperatura de operação: -40 °C + +85 °C  
Temperatura mínima de instalação: -10 °C  
Resistência aos agentes químicos: Boa resistência às bases, aos óleos, às massas, aos solventes de cloreto. Limitada resistência aos ácidos. Não resistente aos fenóis



SxDxH	Ø	F	€	100	BMN
mm	mm	mm			
15.2x9.4x6.8	3.3	3.6	12,00	100	BMN0905
22x16.2x10.8	5.2	9	21,40	100	BMN0906

indicar no pedido o número de terminais e não de embalagens

-os preços indicados são relativos a 100 unidades



## 1748-BA2

suportes de fixação bidirecionais

Material: Poliamida PA 6.6

Classe de auto-extinção: UL 94-V2

Temperatura de operação: -40 °C ÷ +85 °C

Temperatura mínima de instalação: -10 °C

Resistência aos agentes químicos: Boa resistência às bases, aos óleos, às massas, aos solventes de cloreto. Limitada resistência aos ácidos. Não resistente aos fenóis

CE

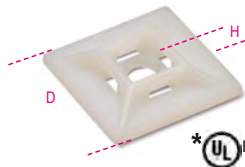

SxDxH mm	F mm	€		
19x19x5.4	3.6	14,50	100	BMB0901
* 28x28x7	4.8	20,10	100	BMB0902
* 28x28x5.8	4.8	18,40	100	BMB0903

## 1748-NA2

suportes de fixação bidirecionais resistente a UV

Material: Poliamida PA 6.6

Classe de auto-extinção: UL 94-V2

Temperatura de operação: -40 °C ÷ +85 °C

Temperatura mínima de instalação: -10 °C

Resistência aos agentes químicos: Boa resistência às bases, aos óleos, às massas, aos solventes de cloreto. Limitada resistência aos ácidos. Não resistente aos fenóis

CE

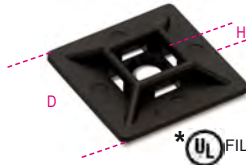

SxDxH mm	F mm	€		
19x19x5.4	3.6	14,50	100	BMN0901
* 28x28x7	4.8	20,10	100	BMN0902
* 28x28x5.8	4.8	18,30	100	BMN0903

indicar no pedido o número de terminais e não de embalagens

-os preços indicados são relativos a 100 unidades

## 1748-S

abraçadeiras autobloqueantes em aço inoxidável

Material: aço inox AISI 304

Dispositivo de fixação: de esfera

Classe de auto-extinção: não inflamável

Plenum rating: AH-1

Resistência aos raios UV: excelente

Temperatura de operação: -60 °C ÷ +300 °C

Temperatura mínima de instalação: -60 °C

Resistência aos agentes químicos: excelente

Normas de referência: EN 62275:2015-02

Classificação: tipo 2 (EN); tipo 2 (UL)

CE

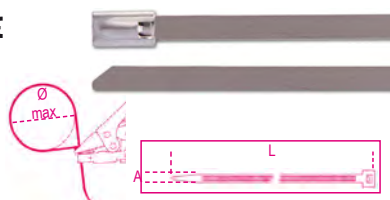

A mm	L mm	ØMAX mm	Trazione N	€		
4.6	125	38	890	88,50	100	BMS1345
4.6	200	61.9	890	92,00	100	BMS2045
7.9	200	61.9	1500	97,50	100	BMS2079
4.6	290	90.6	890	99,00	100	BMS3045
7.9	300	90.6	1500	113,00	100	BMS3079
4.6	360	112.8	890	108,00	100	BMS3745
7.9	360	112.8	1500	123,00	100	BMS3779
7.9	500	163.8	1500	145,00	100	BMS5079
4.6	520	163.8	890	108,00	100	BMS5245
4.6	680	214.8	890	114,00	100	BMS6845
7.9	680	214.8	1500	166,00	100	BMS6879
4.6	840	265.7	890	120,00	100	BMS8445
7.9	840	265.7	1500	196,00	100	BMS8479

## 1748-SC

abraçadeiras autobloqueantes em aço inoxidável,

revestimento em poliéster preto

Material: aço inox AISI 304 + poliéster

Dispositivo de fixação: de esfera

Classe de auto-extinção: não inflamável

Plenum rating: AH-1

Resistência aos raios UV: excelente

Temperatura de operação: -60 °C ÷ +300 °C

Temperatura mínima de instalação: -60 °C

Resistência aos agentes químicos: excelente

Normas de referência: EN 62275:2015-02

Classificação: tipo 2 (EN); tipo 2 (UL)

CE

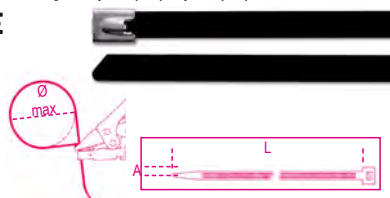

A mm	L mm	ØMAX mm	Trazione N	€		
4.6	125	38	450	92,00	100	BMSC1345
4.6	200	61.9	450	107,00	100	BMSC2045
7.9	200	61.9	800	109,00	100	BMSC2079
4.6	290	90.6	450	120,00	100	BMSC3045
7.9	300	90.6	800	128,00	100	BMSC3079
4.6	360	112.8	450	132,00	100	BMSC3745
7.9	360	112.8	800	144,00	100	BMSC3779
7.9	520	163.8	800	181,00	100	BMSC5079
4.6	520	163.8	450	134,00	100	BMSC5245
4.6	680	214.8	450	153,00	100	BMSC6845
7.9	680	214.8	800	206,00	100	BMSC6879
4.6	840	265.7	450	162,00	100	BMSC8445
7.9	840	265.7	800	247,00	100	BMSC8479

## 1748-BV

abraçadeiras em Velcro, cor branca

Material: polietileno-poliamida (PE-PA)

Temperatura de funcionamento: -20 °C ÷ +60 °C

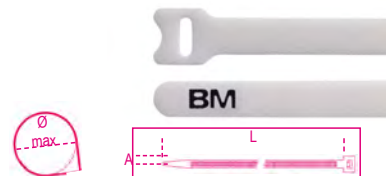

A mm	L mm	Ø MAX mm	F MAX N	€		
12,7	229	55	180	259,00	10	BMBV2312
19	229	55	220	297,00	10	BMBV2319

- Por favor, indique o número de abraçadeiras, e não de embalagens no seu pedido.

- Os preços indicados são para 100 unid.

## 1748-NV

abraçadeiras em Velcro, cor preta

Material: polietileno-poliamida (PE-PA)

Temperatura de funcionamento: -20 °C ÷ +60 °C



A mm	L mm	Ø MAX mm	F MAX N	€		
12,7	229	55	180	259,00	10	BMNV2312

- Por favor, indique o número de abraçadeiras, e não de embalagens no seu pedido.

- Os preços indicados são para 100 unid.

## 1743

alicate para abraçadeiras em Nylon

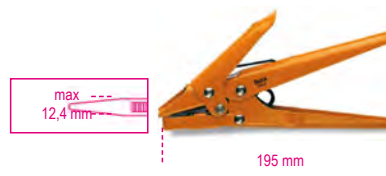

1743	€		
	63,50	1	017430001

## 1743T

Tesoura para abraçadeiras

• Também adequada para corte de pequenos cabos (3x1.5mm<sup>2</sup>; 1x17mm<sup>2</sup>)



1743T	€		
	37,50	1	017430100





## 1748-N

ferramentas de instalação para abraçadeiras em nylon, 2,5 a 4,8 mm de largura  
Corte automático quando a tensão definida é atingida.  
Com sistema de ajuste da tensão de aperto.

Material: estrutura em polímero e fibra de vidro, partes internas em metal



BM1100 € 70,50 1 BM1100

## 1748-ST

pinças automáticas para abraçadeiras em aço inoxidável,  
para abraçadeiras de 4,6 a 9 mm,  
com controlo automático da tensão e corte



BM1105 € 271,00 1 BM1105

## 1638M

revestimento termorretráctil fino, em mini caixa

Relação de retração: 2:1  
Material: polietileno  
Temperatura de funcionamento: -55 °C ÷ +125 °C  
Temperatura de retração: +70 °C ÷ +125 °C  
VRMS máximo: 600 V  
Grau de auto-extinção: VW-1 (UL 224)  
Sem halogénio



L	Ø1	Ø2	€	1	BMGBS016MNE
1,6	12	1,6	0,8	20,70	1
2,4	11	2,4	1,2	20,70	1
3,2	11	3,2	1,6	20,70	1
4,8	10	4,8	2,4	20,70	1
6,4	9	6,4	3,2	20,70	1
9,5	7	9,5	4,8	20,70	1
12,7	6	12,7	6,4	20,70	1
19	5	19,1	9,5	21,10	1
25,4	3,5	25,4	12,7	21,50	1

## 1639ESB

fita isolante em PVC

Temperatura de operação: 0-90 °C  
Carga de ruptura: 28N/cm equivalente a 18,6 N/mm²  
Alongamento em ruptura: 200%  
Aderência ao aço: 2,2N/cm  
Aderência ao dorso: 2 N/cm  
Rigidez dielétrica: 45kV/mm  
Inflamabilidade: retardante de chama  
Normas de referência: IEC 60454-2  
Classificação: CEI EN 60454-3-1-5/F-PVCP/90



S	A	L	€	10	BMESB1510BI
0,15	15	10	0,95	10	BMESB1510BI
0,15	15	10	0,95	10	BMESB1510BL
0,15	15	10	0,95	10	BMESB1510GI
0,15	15	10	0,95	10	BMESB1510GR
0,15	15	10	1,06	10	BMESB1510GV
0,15	15	10	0,95	10	BMESB1510MA
0,15	15	10	0,95	10	BMESB1510NE
0,15	15	10	0,95	10	BMESB1510RO
0,15	15	10	0,95	10	BMESB1510VE
0,15	15	25	2,31	10	BMESB1525BI
0,15	15	25	2,31	10	BMESB1525BL
0,15	15	25	2,31	10	BMESB1525GI
0,15	15	25	2,31	10	BMESB1525GR
0,15	15	25	2,42	10	BMESB1525GV
0,15	15	25	2,31	10	BMESB1525MA
0,15	15	25	2,31	10	BMESB1525NE
0,15	15	25	2,31	10	BMESB1525RO
0,15	15	25	2,31	10	BMESB1525VE
0,15	19	25	2,53	10	BMESB1925BI
0,15	19	25	2,53	10	BMESB1925BL
0,15	19	25	2,53	10	BMESB1925GI
0,15	19	25	2,53	10	BMESB1925GR
0,15	19	25	2,63	10	BMESB1925GV
0,15	19	25	2,53	10	BMESB1925MA
0,15	19	25	2,53	10	BMESB1925NE
0,15	19	25	2,53	10	BMESB1925RO
0,15	19	25	2,53	10	BMESB1925VE
0,15	25	25	3,60	8	BMESB2525BI
0,15	25	25	3,60	8	BMESB2525BL
0,15	25	25	3,60	8	BMESB2525GI
0,15	25	25	3,60	8	BMESB2525GR
0,15	25	25	3,70	8	BMESB2525GV
0,15	25	25	3,60	8	BMESB2525MA
0,15	25	25	3,60	8	BMESB2525NE
0,15	25	25	3,60	8	BMESB2525RO
0,15	25	25	3,60	8	BMESB2525VE
0,15	50	25	5,50	4	BMESB5025NE

## 1639ESC

fita isolante em PVC

Temperatura de operação: 0-80 °C  
Carga de ruptura: 28N/cm equivalente a 18,6 N/mm²  
Alongamento em ruptura: 200%  
Aderência ao aço: 2,2N/cm  
Aderência ao dorso: 2,2 N/cm  
Rigidez dielétrica: 38kV/mm  
Inflamabilidade: retardante de chama  
Normas de referência: ASTM-D-1000 ; UL510  
Classificação: CEI EN 60454-3-1-5/F-PVCP/90



S mm 0,18 A mm 19 L m 20 € 3,40 10 BMESC1920NE

## 1639ETA

fita isolante em PVC para altas temperaturas

Temperatura de operação: -18 ÷ +105 °C  
Carga de ruptura: 35N/cm equivalente a 19,4 N/mm²  
Alongamento em ruptura: 300%  
Aderência ao aço: 3,1N/cm  
Aderência ao dorso: 2,7 N/cm  
Rigidez dielétrica: 55,5kV/mm  
Inflamabilidade: retardante de chama  
Normas de referência: ASTM-D-1000 ; UL510  
Classificação: CEI EN 60454-3-1-5/F-PVCP/90



S mm 0,18 A mm 19 L m 20 € 10,10 1 BMETA1920NE

## 1639EAB

fita isolante auto-aglomerante a base de EPR

Temperatura de operação: -40 ÷ +90 °C  
Carga de ruptura: 2,4 N/mm²  
Alongamento em ruptura: 750%  
Rigidez dielétrica: 29,5kV/mm  
Inflamabilidade: retardante de chama  
Normas de referência: ASTM-D-4388; ASTM-D-4325  
Resistência excelente a: humidade, corrosão e agentes químicos



S mm 0,76 A mm 19 L m 9 € 20,70 1 BMEAB1909NE



**Beta**



**Beta**



## PARA A PROMOÇÃO DAS SUAS VENDAS!

- MAIOR VISIBILIDADE
- CÓDIGO DE BARRAS
- EXPOSIÇÃO EFICIENTE

### PACK BLISTER:

- PVC à prova de rasgão
- 4 formatos para optimização do espaço de exposição
- Sistema de fixação de nova geração com banda elástica



## 42K



mm	€	Hand	Code
5,5x5,5	9,30	5	000429505
6x6	9,40	5	000429506
7x7	9,50	5	000429507
8x8	9,80	5	000429508
9x9	10,20	5	000429509
10x10	10,50	5	000429510
11x11	11,00	5	000429511
12x12	11,10	5	000429512
13x13	11,20	5	000429513
14x14	12,80	5	000429514
15x15	14,10	5	000429515
16x16	14,70	5	000429516
17x17	15,30	5	000429517
18x18	16,30	5	000429518
19x19	16,80	5	000429519
20x20	18,90	3	000429520
21x21	20,30	3	000429521
22x22	20,80	3	000429522
23x23	22,40	3	000429523
24x24	23,80	3	000429524
25x25	25,00	2	000429525
26x26	27,00	2	000429526
27x27	29,00	2	000429527
28x28	29,50	2	000429528
29x29	32,50	2	000429529
30x30	34,00	2	000429530
32x32	38,00	2	000429532

## 55K



mm	€	Hand	Code
6x7	5,30	5	000559012
8x9	5,40	5	000559021
10x11	5,60	5	000559030
10x12	7,60	5	000559033
10x13	8,30	5	000559035
12x13	6,30	5	000559042
12x14	8,50	5	000559045
13x17	9,90	5	000559051
14x15	7,90	5	000559054
14x17	10,70	5	000559057
16x17	9,00	5	000559060
17x19	11,90	2	000559063
18x19	10,50	2	000559066
19x22	13,50	2	000559069
20x22	11,90	2	000559075
21x23	12,60	2	000559078
22x24	14,60	2	000559081
24x26	15,00	2	000559087
24x27	16,30	2	000559090
25x28	17,10	2	000559096
27x29	19,10	2	000559099
27x30	22,00	2	000559102
30x32	21,20	2	000559108

## 90K



mm	€	Hand	Code
6x7	11,70	5	000909006
8x9	12,50	5	000909012
10x11	13,80	5	000909018
12x13	15,00	5	000909027
14x15	16,30	5	000909033
16x17	18,60	5	000909039
18x19	21,70	5	000909045
20x22	24,80	3	000909051
21x23	28,00	2	000909057

mm	€	Hand	Code
24x26	31,00	2	000909063
24x27	34,50	2	000909067
25x28	37,50	2	000909070
27x29	40,50	2	000909073
30x32	45,50	2	000909080

## 93K



mm	€	Hand	Code
21x22	47,00	3	000939021

## 94K



mm	€	Hand	Code
8x10	20,20	2	000949008
9x11	21,00	2	000949009
10x11	22,00	2	000949010
11x13	22,60	2	000949011
12x14	23,90	2	000949012
13x15	23,90	2	000949013
14x15	28,00	2	000949014
14x17	29,00	2	000949015
17x19	29,50	2	000949017
19x22	31,00	2	000949019
22x24	38,50	2	000949022
24x27	42,00	2	000949024
30x32	54,50	2	000949030

## 96/SC9



€	Hand	Code
23,80	1	000960374

## 96/ST6K



€	Hand	Code
16,80	3	000969370

## 96N/ST6K



€	Hand	Code
11,90	3	000969640

## 96BPA/SC9



€	Hand	Code
54,50	1	000961974

## 96BP-CL/SC9



€	Hand	Code
60,50	1	000961619

## 96BPC/SC9



€	Hand	Code
49,50	1	000960354

## 96LBP/SC9



€	Hand	Code
58,00	1	000961354





## 96/BGS7



96/BGS7	€ 35,50	1	000960367
1,5-2-2,5-3-4-5-6 mm			

## 96/BG7



96/BG7	€ 37,50	1	000960368
2,5-3-4-5-6-8-10 mm			

## 96TK



mm	€		
2	13,80	5	000969934
2,5	13,80	5	000969935
3	14,40	5	000969936
4	14,90	5	000969938
5	15,20	5	000969940
6	17,40	5	000969941
8	22,00	3	000969943
10	25,00	3	000969945

## 97BTX/SC8



97BTX/SC8	€ 89,00	1	000970164
T9-T10-T15-T20-T25-T27-T30-T40			

## 97BTXL/SC8



97BTXL/SC8	€ 103,00	1	000970364
T9-T10-T15-T20-T25-T27-T30-T40			

## 111E



L mm	€		
100	26,00	3	001110110
150	27,00	3	001110115
200	33,00	3	001110120
250	40,00	3	001110125
300	53,00	3	001110130
380	104,00	3	001110138
450	173,00	2	001110145
600	240,00	1	001110160

## 111EN



L mm	€		
100	23,80	3	001110410
150	24,90	3	001110415
200	29,00	3	001110420
250	36,00	3	001110425
300	48,50	3	001110430
380	96,00	3	001110438
450	164,00	2	001110445

## 111ER



L mm	€		
200	34,50	3	001110520
250	42,50	3	001110525
300	55,50	2	001110530

## 123/K4



123/K4	€ 37,50	1	001230504
--------	---------	---	-----------

## 142K



mm	€		
6	20,40	3	001429006
7	20,40	3	001429007
8	21,10	3	001429008
9	22,40	3	001429009
10	22,90	3	001429010
11	23,70	3	001429011
12	24,60	3	001429012
13	26,50	3	001429013
14	27,50	2	001429014
15	29,00	2	001429015
16	31,00	2	001429016
17	32,00	2	001429017
18	34,50	2	001429018
19	35,00	2	001429019
21	45,50	1	001429021
22	47,00	1	001429022
24	54,50	1	001429024

## 192/S2



192/S2	€ 73,50	1	001920070
8x10/12x13 mm 16x17/18x19 mm			

## 195K



mm	€		
8x10	23,30	2	001959010
12x13	26,50	2	001959013
14x15	28,00	2	001959015
16x18	32,50	2	001959018
17x19	34,50	2	001959019

## 374K



L mm	€		
240	41,50	1	003749024



## 410K



Ø mm	€	U	PC
* 3	1,70	10	004109064
* 4	2,38	10	004109076
* 5	2,92	10	004109088
6	1,95	10	004109100
7	2,83	10	004109112
8	3,55	10	004109124
9	4,50	10	004109136
10	5,50	10	004109148

## 412K



Ø mm	€	U	PC
* 3	3,85	10	004129064
* 4	5,10	10	004129076
* 5	6,50	10	004129088
6	4,35	10	004129100
7	6,60	10	004129112
8	8,40	10	004129124
9	10,70	10	004129136
10	12,40	10	004129148

## 415K



Ø mm	€	U	PC
3	4,60	10	004159064
4	6,40	10	004159076
5	7,70	10	004159088
6	10,70	10	004159100
7	15,60	10	004159112
8	20,00	10	004159124
9	26,50	10	004159136
10	31,00	10	004159148

## 720LC/S3K



720LC/S3K	€	U	PC
17-19-21 mm	46,00	1	007209663

## 850MQ



L mm	€	U	PC
233	26,50	1	008500910

## 855P



L mm	€	U	PC
240	80,00	1	008550010

## 860/58K



L mm	€	U	PC
126	85,00	1	008609884

## 860LP



SxA mm	€	U	PC
0,5x3	2,09	5	008600005
0,6x4,5	2,09	5	008600010
0,8x5,5	2,09	5	008600015
1x5,5	2,09	5	008600020
1,2x6,5	2,09	5	008600025

## 860PH



PH	€	U	PC
0	2,09	5	008600220
1	2,09	5	008600225
2	2,09	5	008600230
3	2,09	5	008600245
4	3,00	5	008600250

## 860PZ



PZ	€	U	PC
1	2,09	5	008600320
2	2,09	5	008600325
3	2,09	5	008600330
4	3,00	5	008600335

## 860PE



mm	€	U	PC
2	2,22	5	008600101
2,5	2,22	5	008600102
3	2,22	5	008600103
4	2,22	5	008600104
5	2,22	5	008600105
6	2,22	5	008600106
8	2,79	5	008600108
10	2,79	5	008600110

## 860TX



Ø	€	U	PC
T6	2,79	5	008600704
T7	2,79	5	008600705
T8	2,79	5	008600710
T9	2,79	5	008600715
T10	2,22	5	008600720
T15	2,22	5	008600725
T20	2,22	5	008600730
T25	2,22	5	008600735
T27	2,22	5	008600740
T30	2,22	5	008600745
T40	2,22	5	008600750

## 860RTX



Ø	€	U	PC
T9	3,00	5	008600550
T10	3,00	5	008600555
T15	3,00	5	008600560
T20	3,00	5	008600565
T25	3,00	5	008600570
T27	3,00	5	008600575
T30	3,00	5	008600580
T40	3,00	5	008600585

## 860/C27



860/C27	€	U	PC
	97,00	1	008600880

## 861MIX/A10



861MIX/A10	€	U	PC
	32,50	1	008610800

## 861TX/A10



861TX/A10	€	U	PC
	35,00	1	008610870

## 861MIX/A31



861MIX/A31	€ 80,00	1	008610802
------------	---------	---	-----------

## 862F/A7



862F/A7	€ 55,50	1	008620950
---------	---------	---	-----------

## 900K



mm	€		
4	5,30	10	009009040
4,5	5,30	10	009009045
5	5,30	10	009009050
5,5	5,30	10	009009055
6	5,30	10	009009060
7	5,30	10	009009070
8	5,30	10	009009080
9	5,30	10	009009090
10	5,30	10	009009100
11	5,30	10	009009110
12	5,30	10	009009120
13	5,30	10	009009130
14	5,40	10	009009140

## 900/20LK



L mm	€		
100	10,80	5	009009819

## 900/25K



L mm	€		
41	19,80	5	009009830

## 900BG/30K



L mm	€		
128	10,50	5	009009834

## 900/55



L mm	€		
127	52,50	5	009001155

## 900/55ZK



L mm	€		
125	53,50	3	009009882

## 900/58K



L mm	€		
126	81,50	2	009009884

## 910AK



mm	€		
6	8,20	5	009109006
7	8,20	5	009109007
8	8,20	5	009109008
9	8,20	5	009109009
10	8,20	5	009109010
11	8,20	5	009109011
12	8,40	5	009109012
13	8,40	5	009109013
14	8,40	5	009109014
15	8,40	5	009109015
16	9,30	5	009109016
17	9,30	5	009109017
18	9,30	5	009109018
19	9,30	5	009109019
20	9,90	5	009109020
21	9,90	5	009109021
22	10,00	5	009109022

## 910/21K



L mm	€		
125	14,00	5	009109822

## 910/25K



L mm	€		
54,6	24,60	5	009109830

## 910/55



L mm	€		
207	57,00	3	009101155

## 910/58K



L mm	€		
222	89,00	1	009109884

## 920AK



mm	€		
10	6,80	10	009209010
11	6,80	10	009209011
12	6,80	10	009209012
13	7,00	10	009209013
14	7,00	10	009209014
15	7,00	10	009209015
16	7,80	10	009209016
17	7,80	10	009209017
18	7,80	10	009209018
19	7,80	10	009209019
20	8,40	5	009209020
21	8,40	5	009209021
22	8,40	5	009209022
23	9,70	5	009209023
24	9,70	5	009209024
25	9,70	5	009209025
26	9,90	5	009209026
27	9,90	5	009209027
28	9,90	5	009209028
29	10,40	5	009209029
30	10,40	5	009209030
32	10,80	5	009209032

## 920/21K



L mm	€		
125	15,50	5	009209822



## 920/25K

12"



L mm	€	1	009209830
75	24,30	5	009209830

## 920/55

12"



L mm	€	3	009201155
271	57,00	3	009201155

## 920/58K

12"



L mm	€	1	009209926
281	87,50	1	009209926

## 935K



mm	€	5	009359105
6x7	9,50	5	009359105
8x9	10,20	5	009359111
10x11	11,40	5	009359115
12x13	12,60	5	009359117
14x15	14,70	5	009359126
16x17	16,00	5	009359128
18x19	18,80	5	009359131
20x22	22,60	3	009359138

## 937K



mm	€	5	009379006
6x6	10,20	5	009379006
7x7	10,60	5	009379007
8x8	11,10	5	009379008
9x9	11,70	5	009379009
10x10	12,00	5	009379010
11x11	12,60	5	009379011
12x12	14,10	5	009379012
13x13	14,40	5	009379013
14x14	15,70	5	009379014
15x15	17,40	5	009379015
16x16	18,70	5	009379016
17x17	19,50	5	009379017
18x18	19,90	5	009379018
19x19	20,70	5	009379019
20x20	23,20	5	009379020
21x21	25,50	3	009379021
22x22	26,50	3	009379022

## 943BXK



mm	€	5	009439005
5,5	19,90	5	009439005
6	19,90	5	009439006
7	21,20	5	009439007
8	21,20	5	009439008
10	22,90	3	009439010
13	24,50	3	009439013

## 951K



mm	€	5	009519521
2	22,00	5	009519521
2,5	22,00	5	009519525
3	22,00	5	009519530
3,5	22,60	5	009519535
4	22,60	5	009519540
4,5	24,80	5	009519545
5	24,80	5	009519550
6	28,50	5	009519560
8	30,50	5	009519580
10	38,50	5	009519610

## 1032K



L mm	€	5	010329013
140x0,9	28,00	5	010329013
140x1,3	27,50	5	010329014
180	29,50	5	010329017

## 1033K



L mm	€	5	010339013
140x0,9	31,50	5	010339013
140x1,3	30,50	5	010339014
180	32,00	5	010339017

## 1034K



L mm	€	5	010349013
130x0,9	31,50	5	010349013
130x1,3	30,50	5	010349014
170	32,00	5	010349017

## 1036K



L mm	€	5	010369013
140x0,9	30,00	5	010369013
140x1,3	29,50	5	010369014
175	30,50	5	010369017

## 1037K



L mm	€	5	010379013
140x0,9	33,50	5	010379013
140x1,3	32,00	5	010379014
175	33,50	5	010379017

## 1038K



L mm	€	5	010389013
135x0,9	33,50	5	010389013
135x1,3	32,00	5	010389014
175	33,50	5	010389017

## 1044NK



250	€	5	010449025
250	32,50	5	010449025

## 1048NK



L mm	€	3	010489910
175	35,00	3	010489910
250	38,00	5	010489915

## 1048VNK



L mm	€	5	010489111
175	29,50	3	010489111
250	33,50	5	010489116

## 1052K



L mm	€	Hand	Code
140	30,00	3	010529014
190	33,50	3	010529019
240	37,00	3	010529024

## 1082K



L mm	€	Hand	Code
140	29,00	5	010829004
160	30,00	5	010829006

## 1082GK



L mm	€	Hand	Code
140	24,90	5	010829064
160	26,00	5	010829066

## 1082BMK



L mm	€	Hand	Code
140	36,00	3	010829034
160	39,50	3	010829036

## 1082GBMK



L mm	€	Hand	Code
140	31,50	3	010829264
160	35,50	3	010829266

## 1084K



L mm	€	Hand	Code
160	33,50	3	010849006

## 1084GK



L mm	€	Hand	Code
160	29,50	5	010849066

## 1084BMK



L mm	€	Hand	Code
160	41,00	3	010849036

## 1084GBMK



L mm	€	Hand	Code
160	45,00	3	010849266

## 1088K



L mm	€	Hand	Code
160	41,50	2	010889006

## 1088BMK



L mm	€	Hand	Code
160	51,00	2	010889036

## 1096K



L mm	€	Hand	Code
200	26,00	5	010969020

## 1098K



L mm	€	Hand	Code
190	22,30	5	010989190
220	25,00	5	010989220

## 1098PLK



L mm	€	Hand	Code
220	28,00	5	010989320

## 1112K



L mm	€	Hand	Code
200	29,50	2	011129020

## 1122K



L mm	€	Hand	Code
250	40,00	2	011229020

## 1123K



L mm	€	Hand	Code
250	40,00	2	011239020

## 1124K



L mm	€	Hand	Code
250	40,00	2	011249020

## 1128BAX



L mm	€	U	PC
150	37,00	5	011280088

## 1128BMX



L mm	€	U	PC
147	19,60	5	011280051

## 1128BSX



L mm	€	U	PC
148	33,50	5	011280061

## 1128FX



L mm	€	U	PC
145	35,50	5	011280090

## 1128FXS



L mm	€	U	PC
145	42,50	5	011280095

## 1130BMX



L mm	€	U	PC
185	22,00	1	011300002

## 1132K



L mm	€	U	PC
170	56,50	2	011329107

## 1132BMK



L mm	€	U	PC
170	69,50	2	011329137

## 1142BMK



L mm	€	U	PC
160	45,50	3	011429036

## 1144T



L mm	€	U	PC
112	23,30	1	011440060

## 1149F



L mm	€	U	PC
175	19,30	1	011490010

## 1150K



L mm	€	U	PC
160	25,50	5	011509046
180	28,00	5	011509048
200	30,00	5	011509050
220	33,00	2	011509052

## 1150GK



L mm	€	U	PC
160	23,90	5	011509066
180	26,00	5	011509068
200	29,00	5	011509070
220	30,00	2	011509072

## 1150BMK



L mm	€	U	PC
160	31,50	3	011509146
180	35,00	3	011509148
200	38,50	3	011509150
220	41,00	2	011509152

## 1150GBMK



L mm	€	U	PC
160	29,50	3	011509266
180	31,50	3	011509268
200	36,00	3	011509270
220	38,50	2	011509272

## 1162K



L mm	€	U	PC
160	30,00	5	011629006
200	35,00	5	011629010

## 1162GK



L mm	€	U	PC
160	25,50	5	011629066
200	29,50	5	011629070





## 1162BMK



L mm	€	Handedness	Quantity	Product Code
160	37,00	↔	3	011629036
200	41,00	↔	3	011629040

## 1162GBMK



L mm	€	Handedness	Quantity	Product Code
160	31,50	↔	3	011629266
200	37,50	↔	3	011629270

## 1164K



L mm	€	Handedness	Quantity	Product Code
160	32,50	↔	5	011649006
200	37,00	↔	5	011649010

## 1164BMK



L mm	€	Handedness	Quantity	Product Code
160	40,00	↔	3	011649036
200	45,00	↔	3	011649040

## 1166K



L mm	€	Handedness	Quantity	Product Code
160	30,00	↔	5	011669006
200	35,00	↔	5	011669010

## 1166GK



L mm	€	Handedness	Quantity	Product Code
160	25,50	↔	5	011669066
200	29,50	↔	5	011669070

## 1166BMK



L mm	€	Handedness	Quantity	Product Code
160	37,00	↔	3	011669036
200	41,00	↔	3	011669040

## 1166GBMK



L mm	€	Handedness	Quantity	Product Code
160	31,50	↔	3	011669266
200	37,50	↔	3	011669270

## 1168K



L mm	€	Handedness	Quantity	Product Code
160	32,50	↔	5	011689006
200	37,00	↔	5	011689010

## 1168GK



L mm	€	Handedness	Quantity	Product Code
160	28,00	↔	5	011689066
200	31,50	↔	5	011689070

## 1168BMK



L mm	€	Handedness	Quantity	Product Code
160	40,00	↔	3	011689036
200	45,00	↔	3	011689040

## 1168GBMK



L mm	€	Handedness	Quantity	Product Code
160	35,50	↔	3	011689266
200	40,00	↔	3	011689270

## 1201E/K



SxAxL mm	€	Handedness	Quantity	Product Code
0,4x2,5x50	4,65	↔	5	012019203
0,4X2,5x75	4,85	↔	5	012019206
0,5x3x75	4,90	↔	5	012019209
0,5x3x100	5,30	↔	5	012019212
0,6x3,5X75	5,30	↔	5	012019218
0,6x3,5x100	5,50	↔	5	012019221
0,8x4x100	5,50	↔	5	012019230
0,8x4x125	5,80	↔	5	012019233
0,8x4X150	6,30	↔	5	012019236
1,0x5,5x100	6,80	↔	5	012019239
1,0x5,5X125	7,20	↔	5	012019240
1,0x5,5x150	7,30	↔	5	012019242
1,2x6,5x100	8,10	↔	5	012019248
1,2x6,5x125	8,40	↔	5	012019250
1,2x6,5x150	8,50	↔	5	012019251
1,2x8x150	11,00	↔	3	012019257
1,2x8X200	11,60	↔	3	012019260
1,6x10x200	13,50	↔	3	012019266

## 1201EN/K



SxAxL mm	€	Handedness	Quantity	Product Code
0,8x4x30	6,80	↔	3	012019303
1,2x6,5x30	7,00	↔	3	012019306

## 1202E/K



PHxDxL mm	€	Handedness	Quantity	Product Code
0x3x60	4,85	↔	5	012029203
0x3X100	5,50	↔	5	012029206
1x4,5x80	6,30	↔	5	012029209
1x4,5x120	7,00	↔	5	012029212
2x6x100	8,40	↔	5	012029218
2x6x150	9,00	↔	5	012029221
3x8x150	11,30	↔	3	012029224
4x9,5x200	14,70	↔	3	012029227

## 1202EN/K



PHxDxL mm	€	Handedness	Quantity	Product Code
1x4,5x30	6,80	↔	3	012029303
2x6x30	7,00	↔	3	012029306

## 1204E/K



SxDxL mm	€	Handedness	Quantity	Product Code
0,4x2,5x60	4,80	↔	5	012049103
0,6x3x75	4,90	↔	5	012049106
0,5x3x100	5,10	↔	5	012049109
0,8x4x100	5,70	↔	5	012049112
0,8x4x125	5,90	↔	5	012049115
1,0x5x125	6,90	↔	5	012049118
1,0x5x150	7,40	↔	5	012049121
1,2x6,5x150	8,10	↔	5	012049124

## 1207E TX/K



	€	🔧	📄
T5	7,20	5	012079105
T6	7,60	5	012079106
T7	7,80	5	012079107
T8	7,90	5	012079108
T9	8,30	5	012079109
T10	9,40	5	012079110
T15	9,50	5	012079115
T20	9,60	5	012079120
T25	9,90	5	012079125
T27	10,50	5	012079127
T30	10,60	5	012079130
T40	12,40	2	012079140
T45	13,60	2	012079145

## 1208E RTX/K



	€	🔧	📄
T9	8,40	5	012089109
T10	9,40	5	012089110
T15	9,90	5	012089115
T20	10,10	5	012089120
T25	10,30	5	012089125
T27	11,00	5	012089127
T30	11,50	5	012089130
T40	13,70	2	012089140

## 1209E PZ/K



PZ	€	🔧	📄
0	5,70	5	012099200
1	7,30	5	012099203
2	9,40	5	012099206
3	14,00	3	012099209
4	15,30	3	012099212

## 1209EN-PZ/K



	€	🔧	📄
1	6,80	3	012099303
2	7,00	3	012099306

## 1253



SxAxL mm	€	🔧	📄
0,5x3,5x100	11,30	5	012530001

## 1254



SxAxL mm	€	🔧	📄
0,5x3x44	12,40	5	012540001

## 1260K



SxAxL	€	🔧	📄
0,4x2,5x50	6,50	5	012609003
0,4x2,5x75	6,70	5	012609006
0,5x3x75	6,90	5	012609009
0,5x3x100	7,10	5	012609012
0,6x3,5x75	7,30	5	012609018
0,6x3,5x100	7,40	5	012609021
0,8x4x100	8,10	5	012609030
0,8x4x125	8,40	5	012609033
0,8x4x150	8,80	5	012609036
1x5,5x100	9,30	5	012609039
1x5,5x150	10,30	5	012609042
1,5x6,5x100	11,00	5	012609048
1,2x6,5x150	11,80	5	012609051
1,2x8x150	14,40	3	012609057
1,2x8x200	14,80	3	012609060
1,6x10x200	17,90	3	012609066

## 1260NK



SxAxL mm	€	🔧	📄
0,8x4x30	8,50	5	012609103
1,2x6,5x30	9,50	5	012609106

## 1260EK



SxAxL mm	€	🔧	📄
1,2x6,5x150	15,30	3	012609156
1,2x8x175	18,80	3	012609157
1,6x10x200	21,50	2	012609159
2x12x250	24,90	2	012609162

## 1262K



PHxDxL mm	€	🔧	📄
0x3x60	6,90	5	012629003
0x3x100	7,30	5	012629006
1x4,5x80	9,00	5	012629009
1x4,5x120	9,80	5	012629012
2x6x100	11,00	5	012629018
2x6x150	11,90	5	012629021
3x8x150	15,90	3	012629024
4x10x200	20,20	3	012629027

## 1262NK



PHxDxL	€	🔧	📄
1x4,5x30	8,50	5	012629103
2x6x30	9,50	5	012629106

## 1262EK



PHxDxL mm	€	🔧	📄
2x6x150	15,30	3	012629153
3x8x175	18,60	3	012629156
4x10x200	23,10	3	012629159

## 1264K



SxDxL mm	€	🔧	📄
0,5x2,5x60	6,50	5	012649003
0,6x3x75	6,90	5	012649006
0,6x3x100	7,10	5	012649009
0,8x4x100	8,10	5	012649012
0,8x4x125	8,40	5	012649015
1x5x125	9,50	5	012649018
1x5x150	10,00	5	012649021
1,2x6,5x150	11,80	5	012649024

## 1267TXK



Ø	€	🔧	📄
T5	9,60	5	012679005
T6	10,00	5	012679006
T7	10,30	5	012679007
T8	10,80	5	012679008
T9	11,10	5	012679009
T10	11,50	5	012679010
T15	12,20	5	012679015
T20	12,80	5	012679020
T25	13,90	5	012679025
T27	14,40	5	012679027
T30	15,20	5	012679030
T40	17,50	2	012679040
T45	19,30	2	012679045

## 1268RTXK



	€		
T9	12,00	3	012689009
T10	12,50	3	012689010
T15	12,80	3	012689015
T20	13,90	3	012689020
T25	14,20	3	012689025
T27	15,20	3	012689027
T30	15,40	3	012689030
T40	17,70	2	012689040

## 1269PZK



PZ	€		
0	7,90	5	012699000
1	10,20	5	012699001
2	12,00	5	012699002
3	17,10	3	012699003
4	21,70	3	012699004

## 1269N/PZK



PZ	€		
1	8,50	5	012699011
2	9,50	5	012699012

## 1290K



SxAxL mm	€		
0,4x2,5x50	8,30	5	012909003
0,4x2,5x75	8,50	5	012909006
0,5x3x75	8,70	10	012909009
0,5x3x100	9,20	10	012909012
0,6x3,5x75	9,90	10	012909018
0,6x3,5x100	10,10	10	012909021
0,8x4x100	10,20	10	012909030
0,8x4x125	10,50	10	012909033
0,8x4x150	11,00	10	012909036
1x5,5x100	11,20	10	012909039
1x5,5x150	12,40	10	012909042
1,2x6,5x100	13,90	10	012909048
1,2x6,5x150	14,60	10	012909051
1,2x8x150	18,30	3	012909057
1,2x8x200	19,40	3	012909060
1,6x10x200	22,50	3	012909066

## 1290NK



SxAxL mm	€		
0,8x4x30	10,70	5	012909103
1,2x6,5x30	11,70	5	012909106

## 1290K/INOX



SxAxL mm	€		
0,4x2,5x50	10,60	4	012909403
0,5x3x75	10,90	4	012909409
0,8x4x100	11,10	4	012909430
1,0x5,5x150	14,10	4	012909442
1,2x6,5x150	16,10	4	012909451

## 1292K



PHxDxL mm	€		
0x3x60	7,90	10	012929003
0x3x100	9,00	5	012929006
1x4,5x80	10,80	10	012929009
1x4,5x120	11,80	10	012929012
2x6x100	14,10	10	012929018
2x6x150	15,00	10	012929021
3x8x150	19,20	3	012929024
4x10x200	26,00	3	012929027

## 1292NK



PHxDxL mm	€		
1x4,5x30	10,30	5	012929103
2x6x30	11,10	5	012929106

## 1292K/INOX



PHxDxL mm	€		
0x3x60	9,90	4	012929403
1x4,5x80	11,50	4	012929409
2x6x100	14,10	4	012929418

## 1294K



SxDxL mm	€		
0,5x2,5x60	7,70	5	012949003
0,6x3x75	8,20	5	012949006
0,8x4x100	10,20	5	012949012
1x5x125	12,50	5	012949018

## 1298RTXK



	€		
T9	16,70	5	012989009
T10	17,00	5	012989010
T15	18,00	5	012989015
T20	18,10	5	012989020
T25	18,70	5	012989025
T27	20,00	5	012989027
T30	20,60	5	012989030
T40	22,10	2	012989040

## 1299PZK



PZ	€		
0	11,20	5	012999000
1	13,20	5	012999003
2	17,70	5	012999006

## 1299N/PZK



PZ	€		
1	12,70	5	012999021
2	14,10	5	012999024

## 1472VW



L mm	€		
200	54,00	1	014720051



### 1473P



A Max mm	€		
53	42,00	1	014730020

### 1497BS



L mm	€		
230	27,00	1	014970190

### 1497SS



L mm	€		
245	24,50	1	014970195

### 1497RC



1497RC	€		
	87,50	1	014970351

### 1600Q 8



1600Q 8	€		
	34,00	1	016000008

### 1600Q 10



1600Q 10	€		
	43,00	1	016000010

### 1603K



mm <sup>2</sup>	€		
0+8	19,40	5	016039001

### 1603BK



mm <sup>2</sup>	€		
0+8	71,50	2	016039010

### 1651DGTB

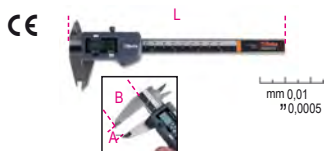

A Max mm	€		
150	113,00	1	016510211
200	147,00	1	016510212
300	192,00	1	016510213

### 1651DGTB/IP

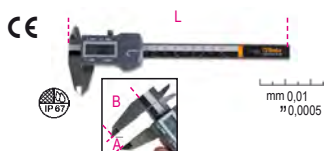

A Max mm	€		
150	185,00	1	016510711

### 1691BM



L m	€		
5	17,60	1	016910205
8	26,50	1	016910208
10	32,00	1	016910210



### 1691MG

CE



L m	€		
5	15,90	1	016910405
8	22,20	1	016910408
10	23,40	1	016910410

### 1692

CE



L m	€		
2	8,60	5	016920052
3	10,70	5	016920053
5	15,30	5	016920055
8	22,00	5	016920058

### 1693

CE



IP54



H mm	€		
100	135,00	1	016930020

### 1729CG

CE



L mm	€		
310	26,00	2	017290200

### 1729DM 450

CE



L mm	€		
450	29,50	4	017290450



### 1729J



L mm 405 € 39,50 4 017290400

### 1729MF



1729MF € 26,00 1 017290500

### 1741U



Ø mm	2,4	3	3,2	4	4,8
Alumínio	•	•	•	•	•
Aço	•	•	•	•	•
Aço inoxidável	•	•	•	•	•

1741U € 51,00 1 017410450

### 1741



Ø mm	2,4	3,2	4	4,8	5
Alumínio	•	•	•	•	•
Aço	•	•	•	•	•
Aço inoxidável	•	•	•	•	•

1741 € 41,00 1 017410003

### 1741P



Ø mm	2,4	3	3,2	4	4,8	5
Alumínio	•	•	•	•	•	•
Aço	•	•	•	•	•	•
Aço inoxidável	•	•	•	•	•	•

1741P € 57,00 1 017410303

### 1741TR



Ø mm	2,4	3	3,2	4	4,8
Alumínio	•	•	•	•	•
Aço	•	•	•	•	•
Aço inoxidável	•	•	•	•	•

1741TR € 44,50 1 017410410

### 1760K



CE 180 mm CAT III-1000V

1760K € 43,00 1 017600140

### 1762K



Ø mm 2-2,5-3 3,5-4-4,5 € 37,00 2 017629001

### 1771



1771 € 10,30 10 017710000

### 1771BM



L mm 170 € 22,50 10 017710050

### 1771HD



L mm 190 € 25,50 5 017710100

### 1772R



L mm 125 € 19,00 5 017720006

### 1773A



L mm 180 € 20,00 10 017730000

### 1773S



L mm 190 € 9,40 1 017730100

### 1777BMT



L mm 170 € 30,50 5 017770050



## 1777T



L mm 160 € 28,50 5 017770030

## 1778MT



L mm 180 € 109,00 1 017780055

## 1783



L mm 215 € 16,70 5 017830021  
240 € 18,70 5 017830024

## 1820



1820 30 € 56,50 1 018200003  
30W  
L = 210mm  
1820 60 € 64,50 1 018200006  
60W  
L = 220mm  
1820 80 € 91,50 1 018200008  
80W  
L = 260mm

## 1822



1822 120 € 139,00 1 018220012  
120W  
LxA = 250x125 mm  
1822 180 € 148,00 1 018220018  
180W  
LxA = 250x125mm  
1822 320 € 184,00 1 018220032  
320W  
LxA = 250x140mm

## 1833XSW



L 145 € 54,00 1 018330011

## 1833S



L mm 150 € 43,00 1 018330002

## 1833M



L mm 162 € 54,00 1 018330003

## 1833MW



L 160 € 99,00 1 018330013

## 1833L



L mm 196 € 90,00 1 018330004

## 1833XL



L mm 300 € 113,00 1 018330005

## 1836AW

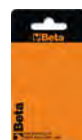

1836AW € 81,50 1 018360051

## 1836B



1836B € 148,00 1 018360200

## 1837F/USB



L 460 € 145,00 1 018370060

# Beta

# Beta



## 1838COMPACT

CE



IP65  
IK07



L mm 120 € 71,00 1 018380011

## 1838PN

CE



IP65  
IK07



L mm 175 € 63,50 1 018380008

## 1838POCKET

CE



IP65  
IK07



L mm 98 € 77,00 1 018380080

## 1838SLIM

CE



IP54



L mm 307 € 82,50 1 018380221

## 1838SW

CE



IP65  
IK07



L mm 260 € 110,00 1 018380142

## 1839BRW

CE



IP20  
IK07



L mm 101 € 104,00 1 018390002

## 1875SP/K3

1/4



1875SP/K3 € 21,20 1 018750010

## 1949F2



Ø 1/4" GAS BSP



g 125 € 15,70 1 019490028

## 1949XS



g 20 € 6,30 25 019490025

## M01K



42

6 - 7 - 8 - 9 - 10 - 11 - 12 - 13 - 14 - 15  
- 16 - 17 - 18 - 19 - 20 - 21 - 22 - 24 - 27  
- 30 - 32 - 36 mm

4,5 kg



M01K € 486,00 1 024509001

## M63K



952

7 - 8 - 10 - 12 - 13 - 14 - 17 - 19 mm

3,4 kg



M63K € 377,00 1 024509063

## M129K



1032 180 mm  
1034 170 mm  
1036 175 mm  
1038 175 mm  
1048N 250 mm  
1052 240 mm  
1082BM 160 mm  
1098 220 mm  
1112 250 mm  
1128BM 145 mm  
1150BM 180 mm  
1166BM 160 mm  
1168BM 160 mm

3,4 Kg



M129K € 483,00 1 024509129

## M213K



1201E 2,5x50 - 3x75 - 4x100 - 5,5x125 - 6,5x150  
- 8x200 mm  
1201EN 4x30 mm  
1202E PH0x60 - PH1x80 - PH2x100 - PH3x150  
mm  
1202EN PH1X30 mm  
1207E/TX T6 - T7 - T8 - T9 - T10 - T15 - T20 - T25  
- T27 - T30 - T40 - T45  
1253 3,5x100 mm

1,8 Kg



M213K € 239,00 1 024509213





# EXPOSITORES PARA POSTOS DE VENDA



  
**SHOP**  
*in shop*



**CONFIGURE O SEU ESPAÇO BETA**

[www.beta-tools.com/planner3d/](http://www.beta-tools.com/planner3d/)



## 38/DS1

expositor de parede  
com 75 punções e escopros



495x260x332 mm

Expositor completo  
**38/DS1** € 820,00 1 000380701

		n.
30	Ø 2 - 3 - 4 - 5 - 6 mm	5
31	Ø 2 - 3 - 4 - 5 - 6 - 8 - 10 mm	5
32	Ø 3 - 4 - 5 mm	5

Expositor vazio  
**38/DVS1** € 122,00 1 000380751

## 38/DS2

expositor de parede  
com 65 punções e escopros

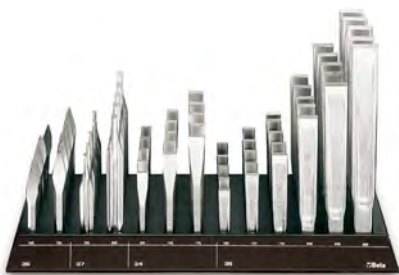

495x260x332 mm

Expositor completo  
**38/DS2** € 1.550,00 1 000380702

		n.
34	125 - 150 - 175 mm	5
35	100 - 125 - 150 - 200 - 250 - 300 mm	5
36	125 - 150 mm	5
37	150 - 200 mm	5

Expositor vazio  
**38/DVS2** € 122,00 1 000380752

## 942BX/DG

expositor de parede  
com 43 chaves de caixa com punho,  
série curta



330x260x332 mm

Expositor completo  
**942BX/DG** € 825,00 1 009420701

		n.
942BX	5 - 5,5 mm	3
	6 - 7 mm	6
	8 - 9 - 10 mm	5
	11 mm	2
	12 mm	3
	13 mm	5

Expositor vazio  
**942BX/DVG** € 108,00 1 009420751

## 943BX/DG

expositor de parede  
com 43 chaves de caixa com punho,  
série longa



330x260x332 mm

Expositor completo  
**943BX/DG** € 885,00 1 009430701

		n.
943BX	5 - 5,5 mm	3
	6 - 7 mm	6
	8 - 9 - 10 mm	5
	11 mm	2
	12 mm	3
	13 mm	5

Expositor vazio  
**943BX/DVG** € 108,00 1 009430751

## 944BX/DG

expositor de parede com 43 chaves de caixa  
sextavadas profundas, com punho, modelo  
longo de binário elevado



330x260x332 mm

Expositor completo  
**944BX/DG** € 1.030,00 1 009440701

		n.
944BX	5 - 5,5 mm	3
	6 - 7 mm	6
	8 - 9 - 10 mm	5
	11 mm	2
	12 mm	3
	13 mm	5

Expositor vazio  
**944BX/DVG** € 108,00 1 009440751

## 943MQ/BG

expositor de parede  
com 30 chaves de caixa com punho



⚡1000 V ⚡ 330x260x332 mm

Expositor completo  
**943MQ/BG** € 680,00 1 009430281

		n.
943MQ	5,5 - 6 - 7 - 8 - 10 - 13 mm	5

Expositor vazio  
**943BG-MQ/DV** € 108,00 1 009430285



## 1203/E1P

expositor de parede  
com 82 chaves de parafusos



495x260x310 mm

Expositor completo € 510,00 1 012031301

		n.
1201	0,4x2,5x50 - 0,5x3x75 - 0,6x3,5x100	7
	0,8x4x100 - 0,8x4x125 mm	6
	1,0x5,5x100 - 1,0x5,5x150 - 1,2x6,5x150 mm	6
	1,2x8x150 mm	5
1202	PH0x3x60 mm	7
	PH1x4,5x80 - PH2x6x100 mm	6
	PH3x8x150 mm	5

Expositor vazio € 135,00 1 012031351

## 1203/E4P

expositor de parede  
com 85 chaves de parafusos



495x260x310 mm

Expositor completo € 491,00 1 012031304

		n.
1201	0,4x2,5x50 - 0,5x3x75 - 0,8x4x125 mm	7
	1,0x5,5x100 - 1,0x5,5x150 - 1,2x6,5x150 mm	6
1204	0,4x2,5x60 - 0,5x3x100 - 0,8x4x100 mm	7
	1,0x5x125 mm	6
1209PZ	PZ0x3x60 mm	7
	PZ1x4,5x80 - PZ2x6x100 mm	6

Expositor vazio € 135,00 1 012031354

## 1203/E5P

expositor de parede  
com 82 chaves de parafusos



495x260x310 mm

Expositor completo € 520,00 1 012031305

		n.
1202	PH0x3x60 mm	7
	PH1x4,5x80 - PH1x4,5x120	6
	PH2x6x100 - PH2x6x150 mm	5
	PH3x8x150 mm	5
1204	0,4x2,5x60 - 0,5x3x100 - 0,8x4x100 mm	7
	1,0x5x125 mm	6
1209PZ	PZ0x3x60 mm	7
	PZ1x4,5x80 - PZ2x6x100 mm	6

Expositor vazio € 135,00 1 012031355

## 1203/E10P

expositor de parede  
com 80 chaves de parafusos



495x260x310 mm

Expositor completo € 700,00 1 012031310

		n.
1207TX	T6	4
	T7	3
	T8	7
	T9 - T10 - T15 - T20 - T25	6
	T27 - T30	3
1208RTX	T9 - T10	3
	T15 - T20 - T25	6
	T27 - T30	3

Expositor vazio € 135,00 1 012031360

## 1263/E78

expositor para parede com 78 chaves de fendas



495x260x310 mm

Expositor completo € 675,00 1 012630510

1260	2,5x75-3x75-3,5x100 mm	7
	4x100-4x125-5,5x100-5,5x150-6,5x150 mm	6
	8x150 mm	4
1262	PH0x60 mm	7
	PH1x80-PH2x100 mm	6
	PH3x150	4

Expositor vazio € 125,00 1 012630511

## 1263/E74

expositor de parede  
com 74 chaves de fendas



495x260x310 mm

Expositor completo € 635,00 1 012630540

1264	2,5x60 mm	7
	3x75 mm	3
	3x100 - 4x100 mm	4
	4x125 - 5x150 mm	2
	5x125 - 6,5x150 mm	4
1262	PH 8x150	3
	PH 3x60 - 3x100 mm	7
	PH 4,5x80 - 4,5x120 mm	6
	PH 6x100 mm	10
	PH 6x150 mm	5

Expositor vazio € 125,00 1 012630541

## 1263/E85

expositor de parede  
com 85 chaves de parafusos



495x260x377 mm

Expositor completo  
**1263/E85** € 755,00 1 012630550

● 1260		n.
2,5x50 mm		7
2,5x75 mm		6
3x75 - 3x100 - 3,5x100 mm		7
4x100 - 4x125 - 5,5x125		6
5,5x150 - 6,5x150 mm		4
8x150 mm		4
● 1260E		3
10x200 mm		2
12x250 mm		2
4x30 - 6,5x30 mm		6

Expositor vazio  
**1263/EV85** € 125,00 1 012630551

## 1263/E50

expositor de parede  
com 50 chaves de parafusos



330x260x269 mm

Expositor completo  
**1263/E50** € 388,00 1 012630570

● 1264		n.
2,5x60 - 3x75 - 3x100 mm		7
4x100 - 4x125 - 5x125 - 5x150 mm		6
6,5x150 mm		5

Expositor vazio  
**1263/EV50** € 108,00 1 012630571

## 1263/E39

expositor de parede  
com 39 chaves de parafusos



330x260x257 mm

Expositor completo  
**1263/E39** € 510,00 1 012630595

⊕ 1268RTX		n.
T9x60 - T10x80 - T15x80		6
T20x100 - T25x100 mm		4
T27x115 mm		3
T30x115 mm		2
T40x130 mm		2

Expositor vazio  
**1263/EV39** € 108,00 1 012630596

## 1263/E70

expositor de parede  
com 70 chaves de parafusos



495x260x327 mm

Expositor completo  
**1263/E70** € 740,00 1 012630560

⊕ 1262		n.
PH0x60 - PH0x100 mm		7
PH1x80 - PH1x120 mm		6
PH2x100 mm		9
PH2x150 - PH3x150 mm		5
PH4x200 mm		4
⊕ 1262E		5
PH2x150 mm		4
PH3x175 mm		4
⊕ 1262N		6
PH1x30 - PH2x30 mm		6

Expositor vazio  
**1263/EV70** € 125,00 1 012630561

## 1263/E62

expositor de parede  
com 62 chaves de parafusos



495x260x257 mm

Expositor completo  
**1263/E62** € 715,00 1 012630590

⊕ 1267TX		n.
T5		5
T6		6
T7		5
T8		6
T9		5
T10 - T15 - T20		6
T25		5
T27 - T30		4
T40 - T45		2

Expositor vazio  
**1263/EV62** € 125,00 1 012630591

## 1263/E40

expositor de parede  
com 40 chaves de parafusos



330x260x327 mm

Expositor completo  
**1263/E40** € 449,00 1 012630580

⊕ 1269		n.
PZ0x60 mm		7
PZ1x80 mm		6
PZ2x100 - PZ3x150 - PZ4x200 mm		5
⊕ 1269N		6
PZ1x30 - PZ2x30 mm		6

Expositor vazio  
**1263/EV40** € 108,00 1 012630581

## 1273MQ/E1

expositor de parede  
com 40 chaves de parafusos



△ 1000 V ⊕ 330x260x332 mm

Expositor completo  
1273MQ/E1 € 570,00 1 012730312

	n.
1272MQ PH0x60 - PH1x80 mm	5
PH2x100 mm	3
PH3x150 mm	2
1274MQ 3x100 - 4x100 - 5,5x125 - 6,5x150 mm	5
8x175 mm	3
10x200 mm	2

Expositor vazio  
1273BG-MQ/DV € 108,00 1 012730651

## 1273MQ/E4

expositor de parede  
com 43 chaves para parafusos



△ 1000 V ⊕ 330x260x332 mm

Expositor completo  
1273MQ/E4 € 775,00 1 012730315

1272MQF 4,5x80 - 6x100 mm	3
1274MQF 3,5x100 - 4,5x100 - 5,5x125 - 6,5x150 mm	3
1275MQ/C 4,5x80 - 6x100 mm	5
1276MQ/C 4,5x80 - 6x100 mm	5
1279MQ/F 4,5x80 mm	3
6x100 mm	2

Expositor vazio  
1273BG-MQ/DV4 € 108,00 1 012730655

## 1293BX/DA

expositor de parede  
com 90 chaves de parafusos



495x260x332 mm

Expositor completo  
1293BX/DA € 1.010,00 1 012930701

	n.
1290 3x75 - 3,5x100 - 4x100 - 4x125 - 5,5x100 - 5,5x150 mm	7
6,5x150 mm	6
8x150 mm	3
10x200 mm	2
1290N 4x30 - 6,5x30 mm	3
1292 PH0x60 - PH1x80 mm	7
PH2x100 mm	6
PH3x150 mm	5
1292N PH1x30 - PH2x30 mm	3

Expositor vazio  
1293BX/DVA € 125,00 1 012930751

## 1293BX/DD

expositor de parede  
com 48 chaves de parafusos



330x260x332 mm

Expositor completo  
1293BX/DD € 476,00 1 012930704

	n.
1294 2,5x60 - 3x75 - 3x100 - 4x100 - 4x150 - 5x125 mm	7
6,5x150 mm	6

Expositor vazio  
1293BX/DVD € 109,00 1 012930754

## 1293BX/DE

expositor de parede  
com 42 chaves de parafusos



330x260x332 mm

Expositor completo  
1293BX/DE € 710,00 1 012930705

	n.
1299PZ PZ0x60 - PZ1x80 mm	7
PZ2x100 mm	6
PZ3x150 - PZ4x200 mm	5
1299N/PZ PZ1x30 - PZ2x30 mm	6

Expositor vazio  
1293BX/DVE € 109,00 1 012930755

## 1293BX/DF

expositor de parede  
com 59 chaves de parafusos



330x260x332 mm

Expositor completo  
1293BX/DF € 940,00 1 012930706

	n.
1297TX T6 - T8 - T10 - T15 - T20 - T25	7
T27 - T30	6
T40	5

Expositor vazio  
1293BX/DVF € 109,00 1 012930756



**C68**

expositor de parede Beta, vazio



1000x560x2200 mm

		€		
C68/1	1 m	2.320,00	1	068000001
C68/2	2 m	4.030,00	1	068000002
C68/3	3 m	5.750,00	1	068000003
C68/4	4 m	7.500,00	1	068000004
C68/5	5 m	9.200,00	1	068000005
C68/6	6 m	10.900,00	1	068000006
C68/7	7 m	12.600,00	1	068000007
C68/8	8 m	14.400,00	1	068000008
C68/9	9 m	16.100,00	1	068000009
C68/10	10 m	17.800,00	1	068000010

**C68N**

expositor de parede Beta, vazio



1000x560x2200 mm

		€		
C68N/1	1 m	2.000,00	1	068000031
C68N/2	2 m	3.710,00	1	068000032
C68N/3	3 m	5.450,00	1	068000033
C68N/4	4 m	7.150,00	1	068000034
C68N/5	5 m	8.850,00	1	068000035
C68N/6	6 m	10.600,00	1	068000036
C68N/7	7 m	12.300,00	1	068000037
C68N/8	8 m	14.000,00	1	068000038
C68N/9	9 m	15.700,00	1	068000039
C68N/10	10 m	17.500,00	1	068000040

**C68 G**

expositor tipo "gôndola"



1000x1120x1600 mm

		€		
C68G/1	1 m	2.110,00	1	068000051
C68G/2	2 m	3.880,00	1	068000052
C68G/3	3 m	5.650,00	1	068000053
C68G/4	4 m	7.450,00	1	068000054

**C88 R/1**

expositor de parede Robur, vazio



1000x560x2200 mm

		€		
C88R/1	1 m	2.440,00	1	088000001

**C88NR/1**

expositor de parede Robur, vazio



1000x560x2200 mm

		€		
C88NR/1	1 m	2.100,00	1	088000031

**C88VE**

tabuleiro para expositor de parede C88

adequado para bobinas das correntes artigo 8120



		€		
C88VE		260,00	1	088000120

**C88SE**

tabuleiro para expositor Genovese adequado para bobinas de corrente



		€		
C88SE		630,00	1	088000130



## 6888

ganchos para expositores  
C60 - C61 - C68 - C88



	€		
6888S1	4,75	10	068880011
6888S2	4,75	10	068880012
6888D1	7,50	5	068880021
6888D2	7,50	5	068880022
6888D4	7,80	5	068880024
6888D5	7,80	5	068880025
6888T1	10,70	5	068880031
6888T2	10,70	5	068880032
6888CT	20,10	1	068880044
6888B	71,50	1	068880100
6888GA	23,60	3	068880120
6888S-1/4	43,00	1	068880605
6888S-3/8	43,00	1	068880610

## 6800 VE

vitrina para expositores C68 e C68 R/1

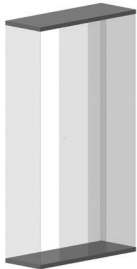

	€		
6800VE/1	1 m	1.160,00	1 068000401
6800VE/2	2 m	1.760,00	1 068000402
6800VE/3	3 m	2.370,00	1 068000403
6800VE/4	4 m	2.970,00	1 068000404
6800VE/5	5 m	3.580,00	1 068000405

## 6800

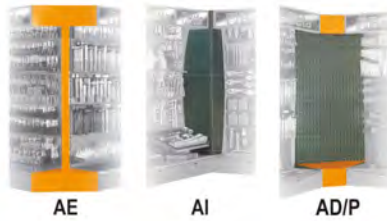

	€		
6800AE	231,00	1	068000145
6800AI	476,00	1	068000140
6800AD/P	810,00	1	068000143



	€		
6800CB/100	266,00	1	068000104
6800FB/100	94,00	1	068000109
6800FO/100	64,50	1	068000108
6800PL	270,00	1	068000137
6800RP/100	85,50	1	068000150
6800GR/37	36,00	1	068000159



	€		
6800PM/40	85,50	1	068000171
6800PM/80	116,00	1	068000172

## 6600 M/14

jogo de 154 ferramentas, com ganchos e sem  
painel



	€		
6600 M/14	2.580,00	1	066000014

## 6600 M/22

sortido de 108 ferramentas,  
com ganchos, sem painel



	€		
6600 M/22	1.490,00	1	066000022

## 6600 M/27

jogo com 25 ferramentas  
com ganchos, sem painel



	€		
6600 M/27	1.040,00	1	066000027

## 6600 M/29

jogo de 173 ferramentas, com ganchos e sem  
painel

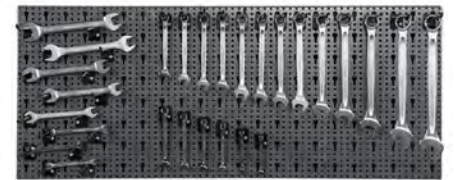

	€		
6600 M/29	2.280,00	1	066000029

## 6600 M/33

Sortido de 37 ferramentas com ganchos e  
sem painel



	€		
6600 M/33	2.010,00	1	066000033





### 6600 M/40

jogo de 100 ferramentas,  
com ganchos e sem painel



6600 M/40 € 2.980,00 1 066000040

### 6600 M/51

jogo de 257 ferramentas  
com ganchos, sem painel



6600 M/51 € 3.180,00 1 066000051

### 6600 M/61

sortido de 71 ferramentas,  
com ganchos, sem painel

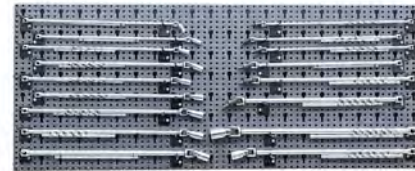

6600 M/61 € 2.870,00 1 066000061

### 6600 M/42

jogo de 65 ferramentas,  
com ganchos sem painel



6600 M/42 € 1.920,00 1 066000042

### 6600 M/52

jogo de 176 ferramentas  
com ganchos, sem painel



6600 M/52 € 2.080,00 1 066000052

### 6600 M/63

jogo de 110 ferramentas  
com ganchos, sem painel

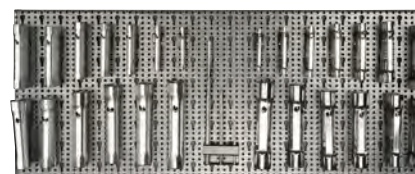

6600 M/63 € 2.610,00 1 066000063

### 6600 M/44

jogo de 48 ferramentas, com ganchos e sem  
painel

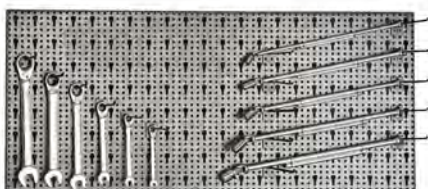

6600 M/44 € 1.670,00 1 066000044

### 6600 M/58

jogo de 150 ferramentas  
com ganchos, sem painel



6600 M/58 € 2.260,00 1 066000058

### 6600 M/73

jogo de 68 ferramentas  
com ganchos, sem painel



6600 M/73 € 1.710,00 1 066000073

### 6600 M/47

jogo com 65 ferramentas  
com ganchos, sem painel



6600 M/47 € 1.700,00 1 066000047

### 6600 M/59

jogo de 220 ferramentas, com ganchos e sem  
painel



6600 M/59 € 2.280,00 1 066000059

### 6600 M/112

jogo de 329 ferramentas,  
com ganchos e sem painel



6600 M/112 € 2.830,00 1 066000112



### 6600 M/116

jogo de 306 ferramentas,  
com ganchos e sem painel



6600 M/116 € 2.650,00 1 066000116

### 6600 M/120

jogo de 163 ferramentas,  
com ganchos e sem painel



6600 M/120 € 1.950,00 1 066000120

### 6600 M/125

jogo de 133 ferramentas,  
com ganchos e sem painel



6600 M/125 € 1.680,00 1 066000125

### 6600 M/126

jogo de 58 ferramentas,  
com ganchos e sem painel



6600 M/126 € 1.010,00 1 066000126

### 6600 M/131

jogo com 92 ferramentas  
com ganchos, sem painel



6600 M/131 € 3.180,00 1 066000131

### 6600 M/174

Sortido de 13 ferramentas com ganchos e  
sem painel



6600 M/174 € 4.760,00 1 066000174

### 6600 M/217

jogo de 74 ferramentas, com ganchos e sem  
painel



6600 M/217 € 2.940,00 1 066000217

### 6600 M/218

jogo de 58 ferramentas, com ganchos e sem  
painel



6600 M/218 € 1.560,00 1 066000218

### 6600 M/223

jogo de 58 ferramentas, com ganchos e sem  
painel



6600 M/223 € 2.030,00 1 066000223

### 6600 M/230

jogo de 78 ferramentas,  
com ganchos e sem painel



6600 M/230 € 2.610,00 1 066000230

### 6600 M/236

jogo de 31 ferramentas,  
com ganchos e sem painel



6600 M/236 € 1.470,00 1 066000236

### 6600 M/241

sortido de 43 ferramentas,  
com ganchos sem painel



6600 M/241 € 1.270,00 1 066000241

INDUSTRIAL  
FINISHING

INDUSTRIAL  
FINISHING



### 6600 M/242

jogo de 91 ferramentas, com ganchos e sem painel



6600 M/242 € 3.050,00 1 066000242

### 6600 M/326

jogo de 155 ferramentas, com ganchos e sem painel



6600 M/326 € 1.490,00 1 066000326

### 6600 M/380

sortido com 71 ferramentas, com ganchos, sem painel



6600 M/380 € 780,00 1 066000380

### 6600 M/253

jogo de 60 ferramentas, com ganchos e sem painel



6600 M/253 € 2.240,00 1 066000253

### 6600 M/327

jogo de 101 ferramentas, com ganchos e sem painel



6600 M/327 € 1.230,00 1 066000327

### 6600 M/406

jogo de 107 ferramentas, com ganchos e sem painel



6600 M/406 € 1.310,00 1 066000406

### 6600 M/315

jogo de 149 ferramentas, com ganchos e sem painel



6600 M/315 € 2.130,00 1 066000315

### 6600 M/330

jogo de 110 ferramentas, com ganchos e sem painel



6600 M/330 € 1.010,00 1 066000330

### 6600 M/417

jogo de 43 ferramentas, com ganchos, sem painel



6600 M/417 € 1.190,00 1 066000417

### 6600 M/320

jogo de 98 ferramentas, com ganchos e sem painel



6600 M/320 € 1.950,00 1 066000320

### 6600 M/371

jogo de 162 ferramentas, com ganchos e sem painel



6600 M/371 € 1.210,00 1 066000371

### 6600 M/427

jogo de 24 ferramentas, com ganchos e sem painel



6600 M/427 € 1.290,00 1 066000427



### 6600 M/430

jogo de 29 ferramentas,  
com ganchos e sem painel



6600 M/430 € 1.260,00 1 066000430

### 6600 M/440

jogo de 140 ferramentas,  
com ganchos e sem painel

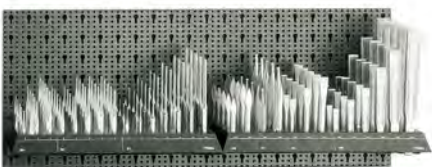

6600 M/440 € 2.370,00 1 066000440

### 6600 M/456

jogo de 41 ferramentas,  
com ganchos, sem expositor



6600 M/456 € 1.830,00 1 066000456

### 6600 M/465

Sortido de 36 ferramentas com ganchos e  
sem painel



6600 M/465 € 2.060,00 1 066000465

### 6600 M/480

jogo de 18 ferramentas,  
com ganchos e sem painel



6600 M/480 € 1.300,00 1 066000480

### 6600 M/485

jogo de 12 ferramentas,  
com ganchos e sem painel



6600 M/485 € 935,00 1 066000485

### 6600 M/510

jogo de 16 ferramentas,  
com ganchos e sem painel



6600 M/510 € 1.290,00 1 066000510

### 6600 M/532

jogo de 24 ferramentas  
com ganchos, sem painel



6600 M/532 € 1.060,00 1 066000532

### 6600 M/534

jogo de 51 ferramentas,  
com ganchos e sem painel



6600 M/534 € 1.690,00 1 066000534

### 6600 M/542

sortido de 53 ferramentas,  
com ganchos sem painel



6600 M/542 € 1.050,00 1 066000542

### 6600 M/548

jogo de 37 ferramentas,  
com ganchos, sem painel

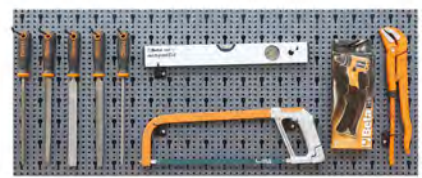

6600 M/548 € 1.010,00 1 066000548

### 6600 M/555

sortido de 28 ferramentas, com ganchos sem  
painel



6600 M/555 € 2.420,00 1 066000555



### 6600 M/561

jogo de 60 ferramentas, com ganchos sem painel



6600 M/561 € 1.450,00 1 066000561

### 6600 M/589

sortido de 31 ferramentas, com ganchos sem painel



6600 M/589 € 1.260,00 1 066000589

### 6600 M/657

jogo de 17 ferramentas, com ganchos sem painel



6600 M/657 € 2.290,00 1 066000657

### 6600 M/565

sortido de 324 ferramentas, com ganchos sem painel



6600 M/565 € 1.000,00 1 066000565

### 6600 M/592

sortido de 40 ferramentas, com ganchos sem painel



6600 M/592 € 1.470,00 1 066000592

### 6600 M/658

jogo de 14 ferramentas com ganchos, sem painel

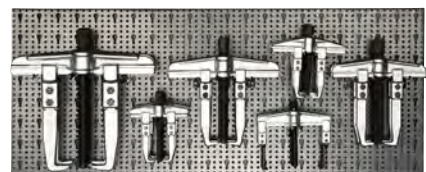

6600 M/658 € 2.550,00 1 066000658

### 6600 M/566

sortido de 324 ferramentas, com ganchos sem painel



6600 M/566 € 2.050,00 1 066000566

### 6600 M/643

sortido com 90 ferramentas, com ganchos, sem painel



6600 M/643 € 2.310,00 1 066000643

### 6600 M/716

jogo de 64 ferramentas, com ganchos e sem painel



6600 M/716 € 2.320,00 1 066000716

### 6600 M/567

sortido de 294 ferramentas, com ganchos sem painel



6600 M/567 € 4.260,00 1 066000567

### 6600 M/650

jogo de 28 ferramentas, com ganchos e sem painel



6600 M/650 € 2.820,00 1 066000650







### 8600 R/11

Jogo de 374 acessórios para cabos, com ganchos, sem painel



8600 R/11 € 1.890,00 1 086000011

### 8600 R/12

Jogo com 259 acessórios para cabos, com ganchos sem painel

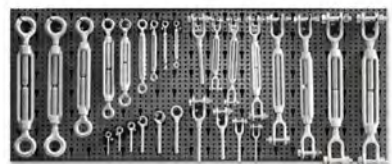

8600 R/12 € 1.840,00 1 086000012

### 8600 R/13

Jogo com 230 acessórios para cabos, com ganchos sem painel

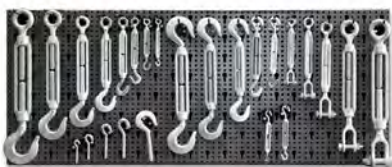

8600 R/13 € 1.560,00 1 086000013

### 8600 R/113

Jogo com 1862 acessórios para cabos, com ganchos sem painel



8600 R/113 € 2.170,00 1 086000113

### 8600 R/114

Jogo com 1045 acessórios para cabos, com ganchos sem painel



8600 R/114 € 2.140,00 1 086000114

### 8600 R/225

Jogo com 64 acessórios para cabos GRAU 8, com ganchos sem painel



8600 R/225 € 1.470,00 1 086000225

### 8600 R/412

Jogo com 348 acessórios para cabos aço inox, com ganchos sem painel

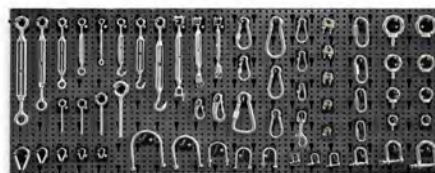

8600 R/412 € 2.160,00 1 086000412



### 8600 R/511

Jogo de 11 bobinas de corrente Genovese, com tabuleiro para expor



8600 R/511 € 1.800,00 1 086000511

### 8600 R/601

Jogo de 50 esticadores com roquete com prateleira e ganchos, sem painel

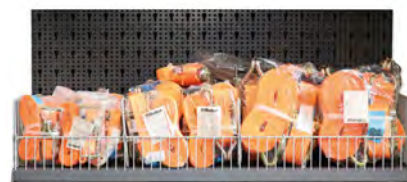

8600 R/601 € 1.240,00 1 086000601  
C88/R601 351,00 1 088000160

### 8600 R/602

Sortido de 120 acessórios para cabos de aço, com grelhas, prateleira e ganchos, sem painel



8600 R/602 € 1.470,00 1 086000602

### 8600 R/611

Jogo de 52 estopos com ganchos, sem painel



8600 R/611 € 940,00 1 086000611  
C88/R611 205,00 1 088000161





# CALÇADO DE SEGURANÇA



## LEGENDA



Com palmilha antipenetração



Com biqueira



Calçado antiestático



Absorção de energia da região do calcanhar



Sola à prova de óleo, hidrocarbonetos e solventes



Rasto antiderrapante



Resistência à flexão repetida > 60.000



Sola resistente ao calor de contato (300 °C/min.)



Calçado não magnético, totalmente isento de peças metálicas



Calçado desenvolvido para garantir a dissipação constante das cargas eletrostáticas do corpo do utilizador para o solo



Formato largo (11) para maior conforto



Calçado desenvolvido para proporcionar isolamento ao frio (-20 °C)

## AVISOS

Antes da utilização, assegure que o calçado é adequado para as suas necessidades e possui uma classe de proteção adaptada ao tipo e local de trabalho. O calçado fabricado pela Beta Utensili cumpre as atuais NORMAS EUROPEIAS.

O empregador deve disponibilizar equipamento de proteção pessoal adequado aos colaboradores expostos a situações de risco (características e categoria do EPI - Equipamento de Proteção Individual).

## OBSOLESCÊNCIA

Devido aos numerosos fatores envolvidos (humidade durante o armazenamento e alterações estruturais dos materiais com o decorrer do tempo), não é possível determinar a duração exata do sapato em armazenamento. Em geral, o calçado feito inteiramente em poliuretano ou com solas de poliuretano tem uma duração máxima prevista de três anos a partir da data de fabrico. O calçado inteiramente em PVC tem uma vida útil expectável de cinco anos a partir da data de fabrico, enquanto o calçado com gáspea de couro e o calçado em borracha, em material termoplástico e EVA tem uma vida útil expectável máxima de dez anos a partir da data de fabrico. Estes períodos de tempo aplicam-se a calçado novo, embalado e armazenado em condições controladas - ou seja, sem mudanças abruptas de temperatura e de humidade relativa.

## NORMAS EUROPEIAS E SIGNIFICADOS EN ISO 20345:2011 - EN ISO 20347:2012

### CONFORMIDADE COM A NORMA EN ISO 20345:2011

A norma especifica requisitos básicos e adicionais (opcionais) para Calçado de Segurança de utilização geral.

Calçado em conformidade com a norma EN ISO 20345:2011 tem marcação "S" (= Segurança), com biqueira resistente a um impacto de 200 Joules.

### CONFORMIDADE COM A NORMA EN ISO 20347:2012

A norma especifica requisitos básicos e adicionais (opcionais) para calçado ocupacional não exposto a riscos mecânicos (impacto ou compressão). Calçado em conformidade com a norma EN ISO 20347:2012 tem marcação "O" (= Ocupacional). Possui muitas das características do calçado descrito acima, embora sem biqueira e sem sola intermédia anti-perfuração.

Tal como no caso dos requisitos básicos para a norma EN ISO 20345:2011, o calçado também pode cumprir alguns requisitos adicionais, que devem ser identificados com símbolos ou classes mencionados na etiqueta que se encontra na língua do sapato.

## NORMAS EUROPEIAS E SIGNIFICADOS EN ISO 20345:2022 - EN ISO 20347:2022

### CONFORMIDADE COM A NORMA EN ISO 20345:2022

A norma especifica requisitos básicos e adicionais (opcionais) para Calçado de Segurança de utilização geral.

Calçado em conformidade com a norma EN ISO 20345:2022 tem marcação "S" (= Segurança), com biqueira resistente a um impacto de 200 Joules.

### CONFORMIDADE COM A NORMA EN ISO 20347:2022

A norma especifica requisitos básicos e adicionais (opcionais) para calçado ocupacional não exposto a riscos mecânicos (impacto ou compressão). Calçado em conformidade com a norma EN ISO 20347:2022 tem marcação "O" (= Ocupacional). Possui muitas das características do calçado descrito acima, embora sem biqueira e sem sola intermédia anti-perfuração.

Tal como no caso dos requisitos básicos para a norma EN ISO 20345:2011, o calçado também pode cumprir alguns requisitos adicionais, que devem ser identificados com símbolos ou classes mencionados na etiqueta que se encontra na língua do sapato.

### Informação relativa a calçado com inserções anti-perfuração

A resistência deste sapato à perfuração foi testada em laboratório, utilizando força e pregos standard. Pregos de diâmetro menor e com maior estática ou cargas dinâmicas estão associados a um maior risco de perfuração. Sob estas circunstâncias, devem considerar-se medidas de prevenção adicionais. O calçado PPE está disponível com três diferentes tipos de inserções anti-perfuração. Estas podem ser metálicas ou não-metálicas e devem ser escolhidas em função dos riscos associados ao tipo de trabalho. Todos os três tipos de inserções garantem proteção contra o risco de perfuração; contudo, cada uma tem as suas vantagens e desvantagens, nomeadamente:

- **Inserção metálica anti-perfuração:** a resistência à perfuração é menos afetada pelo formato do objeto (ex.: diâmetro, geometria, ponta aguçada), mas não cobre toda a superfície da parte inferior do sapato, devido a limitações nas dimensões necessárias para o fabrico do calçado.
- **Inserção não metálica anti-perfuração:** leve, flexível e com uma ampla cobertura em comparação com a inserção metálica, mas a resistência à perfuração pode variar em função do formato do objeto afiado (ex.: diâmetro, geometria, ponta aguçada).

Modelos PS proporcionam maior proteção contra objetos menores em diâmetro do que os modelos PL.

# EN ISO 20345:2011 - EN ISO 20347:2012

## REQUISITOS BÁSICOS + REQUISITOS ADICIONAIS PARA CALÇADO

### CLASSIFICAÇÃO DE CALÇADO

- **Classe I:** calçado em couro e outros materiais, excluindo totalmente em borracha e em polímero.
- **Classe II:** calçado totalmente em borracha (i.e. inteiramente vulcanizada) ou em polímero (i.e. inteiramente moldado).

### REQUISITOS BÁSICOS

- **Todo o calçado:** altura parte superior; zona do calcanhar; desempenho construtivo da sola (construção e resistência de união parte superior/sola); proteção dos dedos e propriedades da biqueira (exceto para calçado abrangido pela EN ISO 20347), resistência antiderrapante.
- **Parte superior:** propriedades dos materiais da parte superior, forro, língua, palmilha/revestimento interior (resistência a rasgões e abrasão, propriedades de tração, permeabilidade a vapor de água, pH, absorção e desabsorção da palmilha/base do pé).
- **Sola exterior:** construção e resistência a rasgões, à abrasão, à flexão, à hidrólise, força de união entre camadas e resistência a óleos de hidrocarbonetos

CLASSE DE PROTEÇÃO	EN ISO 20345:2011				EN ISO 20347:2012				EN ISO 20345:2011		EN ISO 20347:2012		VALORES MÍNIMOS	
	SB	S1	S2	S3	OB	O1	O2	O3	S4	S5	O4	O5		
	Área do calcanhar fechada	0	X	X	X	0	X	X	X	X	X	X	X	
	Biqueira resistente a um impacto de 200 Joules	X	X	X	X	-	-	-	-	X	X	-	-	
<b>A</b>	Calçado antiestático	0	X	X	X	0	X	X	X	X	X	X	X	Resistência elétrica > 100 kΩ ≤ 1000 kΩ
<b>E</b>	Absorção de energia na área do calcanhar	0	X	X	X	0	X	X	X	X	X	X	X	> 20 Joules
<b>WRU</b>	Parte superior impermeável	0	-	X	X	0	-	X	X	-	-	-	-	Penetração: <0.2 g x 60 min Absorção: <30% x 60 min.
<b>P</b>	Resistência à perfuração (insert metálico P)	0	0	-	X	0	0	-	X	0	X	0	X	> 1100 N
<b>CI</b>	Isolamento contra o frio da palmilha	0	0	0	0	0	0	0	0	0	0	0	0	Descida de temperatura ≤ 10 °C num ambiente a 17 °C durante 30'
<b>HI</b>	Isolamento térmico da palmilha	0	0	0	0	0	0	0	0	0	0	0	0	Aumento de temperatura ≤ 22 °C quando colocado numa placa a uma temperatura de 150 °C durante 30'
<b>HRO</b>	Resistência ao contacto com superfícies quentes	0	0	0	0	0	0	0	0	0	0	0	0	Contacto a 300 °C durante 60" - Não derrete
<b>WR</b>	Impermeável	0	0	0	0	0	0	0	0	-	-	-	-	Sem penetração de água
<b>FO</b>	Resistência a hidrocarbonetos	0	X	X	X	0	0	0	0	X	X	0	0	Aumento de volume da única amostra < 12 %
<b>SRC</b>	Sola antiderrapante	X	X	X	X	X	X	X	X					Requisito <b>SRA + SRB</b>

<b>X</b>	Requisito <b>obrigatório</b> para classe de proteção
<b>O</b>	Requisito <b>opcional</b> acrescentado aos obrigatórios, caso identificado
<b>-</b>	Requisito <b>não obrigatório</b> , verificar informação no sapato

#### Calçado antiestático:

O calçado antiestático deve ser usado quando existe a necessidade de minimizar a acumulação de cargas electrostáticas, de forma a eliminar o perigo de combustão de substâncias e vapores inflamáveis e em caso de persistência do risco de choque elétrico de componentes sob tensão. O calçado antiestático não protege contra choques elétricos, limitando-se a criar uma resistência elétrica entre o chão e o pé. Se o perigo de choque elétrico não puder ser totalmente eliminado, devem tomar-se medidas de precaução adicionais como parte do plano de prevenção de acidentes no local de trabalho. Para assegurar que são cumpridos os requisitos antiestáticos, o calçado não pode ser objeto de modificações.

#### Calçado isolante:

O calçado isolante proporciona proteção contra contactos acidentais com componentes elétricos com voltagens até 1000 V, desde que as condições de utilização não interfiram ou alterem a resistência elétrica sob influência de humidade. Salientamos que a resistência elétrica refere-se apenas à parte inferior do calçado, e não à superior.

Classes elétricas para calçado:

Classe 00 500V CA ou 750V CC

Classe 0 1000V CA ou 1500V CC

#### Calçado de dissipação para ambientes EPA:

Calçado de dissipação, especialmente desenvolvido para ambientes EPA (ESDS), que permite a dissipação de cargas electrostáticas do corpo do operador de forma contínua e controlada, protegendo componentes e dispositivos eletrónicos do fenómeno electrostático. O valor de referência da resistência do solo de acordo com a norma CEI EN 61340-5-1: 2016, para utilizador/calçado/pavimento, é <1 × 10<sup>9</sup> Ω.





# EN ISO 20345:2022 - EN ISO 20347:2022

## REQUISITOS BÁSICOS + REQUISITOS ADICIONAIS PARA CALÇADO

### CLASSIFICAÇÃO DE CALÇADO

- **Classe I:** calçado em couro e outros materiais, excluindo totalmente em borracha e em polímero.
- **Classe II:** calçado totalmente em borracha (i.e. inteiramente vulcanizada) ou em polímero (i.e. inteiramente moldado).

### REQUISITOS BÁSICOS

- **Todo o calçado:** altura parte superior; zona do calcanhar; desempenho construtivo da sola (construção e resistência de união parte superior/sola); proteção dos dedos e propriedades da biqueira (exceto para calçado abrangido pela EN ISO 20347), resistência antiderrapante.
- **Parte superior:** propriedades dos materiais da parte superior, forro, língua, palmilha/revestimento interior (resistência a rasgões e abrasão, propriedades de tração, permeabilidade a vapor de água, pH, absorção e desabsorção da palmilha/base do pé).
- **Sola exterior:** construção e resistência a rasgões, à abrasão, à flexão, à hidrólise, força de união entre camadas e resistência a óleos de hidrocarbonetos

CLASSE DE PROTEÇÃO	EN ISO 20345:2022											EN ISO 20347:2022						ERFORDERLICHE MINDESTWERTE
	SB	S1	S2	S3	S3L	S3S	S6	S7	S7L	S7S	OB	O1	O2	O3	O3L	O3S		
Classe	I o II	I	I	I	I	I	I	I	I	I	I o II	I	I	I	I	I		
Área do calcanhar fechada	0	X	X	X	X	X	X	X	X	X	0	X	X	X	X	X		
Biqueira resistente a um impacto de 200 Joules	X	X	X	X	X	X	X	X	X	X	-	-	-	-	-	-		
Sola com rasto	0	0	0	X	X	X	0	X	X	X	0	0	0	X	X	X		
<b>P</b> Resistência à perfuração (insert metálico P)	0	0	0	X	-	-	0	X	-	-	0	0	0	X	-	-	Força de perfuração ≥ 1100N	
<b>PL</b> Resistência à perfuração (insert não-metálico, teste com prego, Ø 4.5 mm)	0	0	0	-	X	-	0	-	X	-	0	0	0	-	X	-		
<b>PS</b> Resistência à perfuração (insert não-metálico, teste com prego, Ø 3.0 mm)	0	0	0	-	-	X	0	-	-	X	0	0	0	-	-	X		
<b>A</b> Calçado antiestático	0	X	X	X	X	X	X	X	X	X	0	X	X	X	X	X	Resistência elétrica > 100 kΩ ≤ 1000 kΩ	
<b>HI</b> Isolamento térmico da palmilha	0	0	0	0	0	0	0	0	0	0	0	0	0	0	0	0	Aumento de temperatura ≤ 22 °C quando colocado numa placa a uma temperatura de 150 °C durante 30'	
<b>CI</b> Isolamento contra o frio da palmilha	0	0	0	0	0	0	0	0	0	0	0	0	0	0	0	0	Descida de temperatura ≤ 10 °C num ambiente a 17 °C durante 30'	
<b>E</b> Absorção de energia na área do calcanhar	0	X	X	X	X	X	X	X	X	X	0	X	X	X	X	X	> 20 Joules	
<b>WR</b> Impermeável	0	0	0	0	0	0	X	X	X	X	0	0	0	0	0	0	Sem penetração de água	
<b>SC</b> Resistência à abrasão da capa de proteção	0	0	0	0	0	0	0	0	0	0	0	0	0	0	0	0	Nenhum furo em toda a espessura após 8.000 ciclos	
<b>SR</b> Antiderrapante em piso cerâmico com glicerina	X	X	X	X	X	X	X	X	X	X	X	X	X	X	X	X	Teste em piso cerâmico com glicerina	
<b>WPA</b> Penetração e absorção de água	0	0	X	X	X	X	-	-	-	-	0	0	X	X	X	X	Absorção de água após 60' ≤ 30%	
<b>HRO</b> Resistência ao contacto com superfícies quentes	0	0	0	0	0	0	0	0	0	0	0	0	0	0	0	0	Contacto a 300 °C durante 60" - Não derrete	
<b>FO</b> Resistência a hidrocarbonetos	0	0	0	0	0	0	0	0	0	0	0	0	0	0	0	0	Aumento de volume da única amostra < 12 %	
<b>LG</b> Ranhura de segurança para escada	0	0	0	0	0	0	0	0	0	0	0	0	0	0	0	0	Largura da área central da sola > 35 mm	

<b>X</b>	Requisito <b>obrigatório</b> para classe de proteção
<b>O</b>	Requisito <b>opcional</b> acrescentado aos obrigatórios, caso identificado
<b>-</b>	Requisito <b>não obrigatório</b> , verificar informação no sapato

### Calçado parcialmente condutor

O calçado parcialmente condutor deve ser utilizado se for necessário minimizar as cargas electrostáticas no menor tempo possível, por exemplo, ao manusear explosivos.

O calçado eletricamente condutivo não deve ser utilizado se o risco de choque de qualquer aparelho elétrico ou componentes sob tensão alternada ou direta não tiver sido completamente eliminado. A fim de assegurar que este calçado é parcialmente condutor, foi especificado um limite superior de resistência de 100 kΩ em estado novo.

### Calçado antiestático:

O calçado antiestático deve ser usado quando existe a necessidade de minimizar a acumulação de cargas eletroestáticas, de forma a eliminar o perigo de combustão de substâncias e vapores inflamáveis e em caso de persistência do risco de choque elétrico de componentes sob tensão. O calçado antiestático não protege contra choques elétricos, limitando-se a criar uma resistência elétrica entre o chão e o pé. Se o perigo de choque elétrico não puder ser totalmente eliminado, devem tomar-se medidas de precaução adicionais como parte do plano de prevenção de acidentes no local de trabalho. Para assegurar que são cumpridos os requisitos antiestáticos, o calçado não pode ser objeto de modificações.

**Os certificados de calçado em conformidade com normas anteriores mantêm-se válidos até ao seu termo**

**EN ISO 20345:2011 S1P SR / S1PS SR**

LINHA	ITEM	REQUISITOS			SETORES RECOMENDADOS						📄
					REQUISITOS ADICIONAIS	SETOR AUTO	CONSTRUÇÃO	ELETRICIDADE	INDÚSTRIA	LOGÍSTICA	
 <b>NEW BASIC</b>	7246NB	FO			X	X	X	X	X	X	631
	7247NB	FO			X	X	X	X	X	X	631
	7248NB	FO RS			X	X	X			X	632
 <b>fitEVOLUTION</b>	7270Y	FO ESD	X	X	X	X	X	X	X	X	643
	7271V	FO ESD	X	X	X	X	X	X	X	X	643
	7272V	FO ESD	X	X	X	X	X	X	X	X	644
 <b>RENEGADE</b>	7340VA	HRO FO	X	X	X	X	X	X	X	X	645
	7340G	HRO FO	X	X	X	X	X	X	X	X	645
	7341V	HRO FO	X	X	X	X	X	X	X	X	646
	7341Y	HRO FO	X	X	X	X	X	X	X	X	646
 <b>O-GRAVITY</b>	7371V	HRO FO ESD	X	X	X	X	X	X	X	X	642

**EN ISO 20345:2011 S1P SRC**

 <b>FLEX</b>	7212G	ESD		X	X	X	X	X	X	X	635
	7212B	ESD		X	X	X	X	X	X	X	634
	7213G	ESD		X	X	X	X	X	X	X	635
 <b>EASY PLUS</b>	7222PEK			X	X	X	X	X	X	X	633
	7223PEK			X	X	X	X	X	X	X	634
 <b>EASY</b>	7246E					X	X	X	X	X	629
 <b>ACTIVE</b>	7316NB	ESD		X	X	X	X	X	X	X	637
	7316NG	ESD		X	X	X	X	X	X	X	637
	7317NA			X	X	X	X	X	X	X	637
 <b>O-GRAVITY</b>	7352B	HRO		X	X	X	X	X	X	X	639
	7352G	HRO ESD	X	X	X	X	X	X	X	X	639
	7352LG	HRO			X	X	X	X	X	X	639
	7372B	HRO	X	X	X	X	X	X	X	X	642
	7376A	HRO	X	X	X	X	X	X	X	X	642

**EN ISO 20347:2012 O2 SRC**

 <b>NEW BASIC</b>	7241NFT	FO			X	X			X	631
	7243NFT	FO RS			X	X			X	631

**EN ISO 20347:2012 O1 / O2 SRC**

 <b>O-GRAVITY</b>	7362B	FO HRO	X	X	X	X				641
	7363N	FO HRO	X	X	X	X				641

**EN ISO 20345:2022 S3 SR / S3S SR**

LINE	ITEM	REQUISITOS			SETORES RECOMENDADOS						📄
					REQUISITOS ADICIONAIS	AGRICULTURA	SETOR AUTO	CONSTRUÇÃO	INDÚSTRIA	ELETRICIDADE	
 <b>NEW BASIC</b>	7241NC	FO			X	X	X	X	X	X	630
	7243NC	FO RS			X	X	X	X			631
	7245NB	FO RS			X	X	X	X			638
 <b>fitEVOLUTION</b>	7273G	FO ESD	X	X	X	X	X	X	X	X	644
	7274G	FO ESD	X	X	X	X	X	X	X	X	644
	7275N	FO ESD	X	X	X	X	X	X	X	X	644
	7276N	FO ESD	X	X	X	X	X	X	X	X	645
 <b>RENEGADE</b>	7342N	HRO FO	X	X	X	X	X	X	X	X	646
	7343N	HRO FO	X	X	X	X	X	X	X	X	646

**EN ISO 20345:2011 S3 SRC**

 <b>FLEX</b>	7214FN			X	X	X	X	X	X	X	635
	7214G	ESD		X	X	X	X	X	X	X	636
	7215FN			X	X	X	X	X	X	X	636
	7218FN	RS		X	X	X	X	X	X	X	636
	7218G	RS ESD		X	X	X	X	X	X	X	636
 <b>EASY PLUS</b>	7220PEK			X	X	X	X	X	X	X	633
	7221PEK	RS		X	X	X	X	X	X	X	633
 <b>EASY</b>	7241EN				X	X	X	X		X	629
	7243EN	RS			X	X	X			X	629
 <b>HEAVY DUTY</b>	7293HM	HRO HI	X		X	X			X	X	647
	7294HM	HRO HI	X		X	X			X	X	647
	7294HMC	HRO HI CI WR	X		X	X			X	X	647
 <b>ACTIVE</b>	7320NA			X	X	X	X	X	X	X	638
	7321NA	RS		X	X	X	X	X	X	X	638
	7322SA			X	X	X	X	X	X	X	638
	7323SA	RS		X	X	X	X	X	X	X	668
 <b>O-GRAVITY</b>	7354N	HRO		X	X	X	X	X	X	X	640
	7356G	HRO		X	X	X	X	X	X	X	640
	7356V	HRO		X	X	X	X	X	X	X	640
	7356LN	HRO		X	X	X	X	X	X	X	640
	7357G	HRO		X	X	X	X	X	X	X	641
	7357V	HRO		X	X	X	X	X	X	X	641
	7381N	HRO WR	X	X	X	X	X	X	X	X	642
	7382N	HRO WR	X	X	X	X	X	X	X	X	643

**EN ISO 20345:2011 S5 SRC**

 <b>BASIC</b>	7328A				X	X	X		X	X	632
	7328N				X	X	X		X	X	632



**7241EN**

Sapato em pele natural, impermeável

- Biqueira de aço
- Palmilha anti-perfuração elástica à prova de aço

EU	UK	mm	€		
35	2,5	230	39,50	1	072410835
36	3,5	237	39,50	1	072410836
37	4,5	244	39,50	1	072410837
38	5	250	39,50	1	072410838
39	6	257	39,50	1	072410839
40	6,5	264	39,50	1	072410840
41	7	270	39,50	1	072410841
42	8	277	39,50	1	072410842
43	9	284	39,50	1	072410843
44	10	290	39,50	1	072410844
45	10,5	297	39,50	1	072410845
46	11	304	39,50	1	072410846
47	12	310	39,50	1	072410847
48	13	317	39,50	1	072410848

CE



S3 SRC

**EN ISO 20345 2011**



**7243EN**

Bota em pele natural, impermeável, com sistema de abertura rápida

- Biqueira de aço
- Palmilha anti-perfuração elástica à prova de aço

EU	UK	mm	€		
35	2,5	230	41,50	1	072430835
36	3,5	237	41,50	1	072430836
37	4,5	244	41,50	1	072430837
38	5	250	41,50	1	072430838
39	6	257	41,50	1	072430839
40	6,5	264	41,50	1	072430840
41	7	270	41,50	1	072430841
42	8	277	41,50	1	072430842
43	9	284	41,50	1	072430843
44	10	290	41,50	1	072430844
45	10,5	297	41,50	1	072430845
46	11	304	41,50	1	072430846
47	12	310	41,50	1	072430847
48	13	317	41,50	1	072430848

CE



S3 RS SRC

**EN ISO 20345 2011**



**7246E**

Sapato aberto, de carmuça

- Biqueira de aço
- Palmilha anti-perfuração em aço flexível

EU	UK	mm	€		
35	2,5	230	41,50	1	072460435
36	3,5	237	41,50	1	072460436
37	4,5	244	41,50	1	072460437
38	5	250	41,50	1	072460438
39	6	257	41,50	1	072460439
40	6,5	264	41,50	1	072460440
41	7	270	41,50	1	072460441
42	8	277	41,50	1	072460442
43	9	284	41,50	1	072460443
44	10	290	41,50	1	072460444
45	10,5	297	41,50	1	072460445
46	11	304	41,50	1	072460446
47	12	310	41,50	1	072460447
48	13	317	41,50	1	072460448

CE



S1P SRC

**EN ISO 20345 2011**







## 7241NC

sapato em pele, impermeável

- Biqueira de aço
- Palmilha antipenetração de aço

EU	UK	mm	€	CE	EN ISO
35	2,5	228	49,50	1	072411635
36	3,5	235	49,50	1	072411636
37	4,5	242	49,50	1	072411637
38	5	248	49,50	1	072411638
39	6	255	49,50	1	072411639
40	6,5	262	49,50	1	072411640
41	7	268	49,50	1	072411641
42	8	275	49,50	1	072411642
43	9	282	49,50	1	072411643
44	10	288	49,50	1	072411644
45	10,5	295	49,50	1	072411645
46	11	302	49,50	1	072411646
47	12	308	49,50	1	072411647
48	13	315	49,50	1	072411648



CE

S3 FO SR

**EN ISO  
20345  
2022**



## 7241NFT

sapato em pele, impermeável

- Sem biqueira
- Sem palmilha antipenetração

EU	UK	mm	€	CE	EN ISO
35	2,5	228	43,00	1	072410735
36	3,5	235	43,00	1	072410736
37	4,5	242	43,00	1	072410737
38	5	248	43,00	1	072410738
39	6	255	43,00	1	072410739
40	6,5	262	43,00	1	072410740
41	7	268	43,00	1	072410741
42	8	275	43,00	1	072410742
43	9	282	43,00	1	072410743
44	10	288	43,00	1	072410744
45	10,5	295	43,00	1	072410745
46	11	302	43,00	1	072410746
47	12	308	43,00	1	072410747
48	13	315	43,00	1	072410748



CE

O2 FO SR

**EN ISO  
20347  
2022**



## 7243NC

botim em pele, impermeável,  
com sistema de abertura rápida

- Biqueira de aço
- Palmilha antipenetração de aço

EU	UK	mm	€	CE	EN ISO
35	2,5	228	51,50	1	072431635
36	3,5	235	51,50	1	072431636
37	4,5	242	51,50	1	072431637
38	5	248	51,50	1	072431638
39	6	255	51,50	1	072431639
40	6,5	262	51,50	1	072431640
41	7	268	51,50	1	072431641
42	8	275	51,50	1	072431642
43	9	282	51,50	1	072431643
44	10	288	51,50	1	072431644
45	10,5	295	51,50	1	072431645
46	11	302	51,50	1	072431646
47	12	308	51,50	1	072431647
48	13	315	51,50	1	072431648



CE

S3 FO SR RS

**EN ISO  
20345  
2022**



## 7243NFT

botim em pele, impermeável, com sistema de abertura rápida

- Sem biqueira
- Sem palmilha antipenetração

EU	UK	mm	€		
35	2,5	228	44,50	1	072430535
36	3,5	235	44,50	1	072430536
37	4,5	242	44,50	1	072430537
38	5	248	44,50	1	072430538
39	6	255	44,50	1	072430539
40	6,5	262	44,50	1	072430540
41	7	268	44,50	1	072430541
42	8	275	44,50	1	072430542
43	9	282	44,50	1	072430543
44	10	288	44,50	1	072430544
45	10,5	295	44,50	1	072430545
46	11	302	44,50	1	072430546
47	12	308	44,50	1	072430547
48	13	315	44,50	1	072430548

CE



O2 FO SR RS

EN ISO  
20347  
2022



## 7245NB

botim em pele, impermeável, com sistema de abertura rápida, cordões com proteção frontal e velcro

- Biqueira de aço
- Palmilha antipenetração de aço

EU	UK	mm	€		
35	2,5	228	56,00	1	072451635
36	3,5	235	56,00	1	072451636
37	4,5	242	56,00	1	072451637
38	5	248	56,00	1	072451638
39	6	255	56,00	1	072451639
40	6,5	262	56,00	1	072451640
41	7	268	56,00	1	072451641
42	8	275	56,00	1	072451642
43	9	282	56,00	1	072451643
44	10	288	56,00	1	072451644
45	10,5	295	56,00	1	072451645
46	11	302	56,00	1	072451646
47	12	308	56,00	1	072451647
48	13	315	56,00	1	072451648

CE



S3 FO SR RS

EN ISO  
20345  
2022



## 7246NB

sapato de camurça, perfurado

- Biqueira de aço
- Palmilha antipenetração de aço

EU	UK	mm	€		
35	2,5	228	48,00	1	072461635
36	3,5	235	48,00	1	072461636
37	4,5	242	48,00	1	072461637
38	5	248	48,00	1	072461638
39	6	255	48,00	1	072461639
40	6,5	262	48,00	1	072461640
41	7	268	48,00	1	072461641
42	8	275	48,00	1	072461642
43	9	282	48,00	1	072461643
44	10	288	48,00	1	072461644
45	10,5	295	48,00	1	072461645
46	11	302	48,00	1	072461646
47	12	308	48,00	1	072461647
48	13	315	48,00	1	072461648

CE



S1P FO SR

EN ISO  
20345  
2022



## 7247NB

sandália em pele

- Biqueira de aço
- Palmilha antipenetração de aço

EU	UK	mm	€		
35	2,5	228	47,50	1	072470635
36	3,5	235	47,50	1	072470636
37	4,5	242	47,50	1	072470637
38	5	248	47,50	1	072470638
39	6	255	47,50	1	072470639
40	6,5	262	47,50	1	072470640
41	7	268	47,50	1	072470641
42	8	275	47,50	1	072470642
43	9	282	47,50	1	072470643
44	10	288	47,50	1	072470644
45	10,5	295	47,50	1	072470645
46	11	302	47,50	1	072470646
47	12	308	47,50	1	072470647
48	13	315	47,50	1	072470648

CE



S1P FO SR

EN ISO  
20345  
2022





## 7248NB

botim em camurça,  
com sistema de abertura rápida

- Biqueira de aço
- Palmilha antipenetração de aço

EU	UK	mm	€		
35	2,5	228	51,50	1	072481635
36	3,5	235	51,50	1	072481636
37	4,5	242	51,50	1	072481637
38	5	248	51,50	1	072481638
39	6	255	51,50	1	072481639
40	6,5	262	51,50	1	072481640
41	7	268	51,50	1	072481641
42	8	275	51,50	1	072481642
43	9	282	51,50	1	072481643
44	10	288	51,50	1	072481644
45	10,5	295	51,50	1	072481645
46	11	302	51,50	1	072481646
47	12	308	51,50	1	072481647
48	13	315	51,50	1	072481648

CE



S1P FO SR RS

EN ISO  
20345  
2022



## 7328A

botas de trabalho "máxima visibilidade" em PVC de nitrilo.  
Com rasto antiderrapante.

- Biqueira de aço
- Palmilha anti-perfuração

EU	UK	mm	€		
38	5	253	43,00	1	073280638
39	6	260	43,00	1	073280639
40	6,5	267	43,00	1	073280640
41	7	273	43,00	1	073280641
42	8	280	43,00	1	073280642
43	9	287	43,00	1	073280643
44	10	293	43,00	1	073280644
45	10,5	300	43,00	1	073280645
46	11	307	43,00	1	073280646
47	12	313	43,00	1	073280647

CE



S5 SRC

EN ISO  
20345  
2011



## 7328N

botas de trabalho em PVC de nitrilo. Com rasto antiderrapante.

- Biqueira de aço
- Palmilha anti-perfuração

EU	UK	mm	€		
38	5	253	43,00	1	073280838
39	6	260	43,00	1	073280839
40	6,5	267	43,00	1	073280840
41	7	273	43,00	1	073280841
42	8	280	43,00	1	073280842
43	9	287	43,00	1	073280843
44	10	293	43,00	1	073280844
45	10,5	300	43,00	1	073280845
46	11	307	43,00	1	073280846
47	12	313	43,00	1	073280847

CE



S5 SRC

EN ISO  
20345  
2011







## 7220PEK

Sapato em pele, impermeável, com aplicações de nylon, biqueira com reforço anti-abrasão

- Biqueira em compósito
- Palmilha anti-perfuração em fibra reforçada

EU	UK	mm	€		
35	2,5	228	72,50	1	072200235
36	3,5	235	72,50	1	072200236
37	4,5	242	72,50	1	072200237
38	5	248	72,50	1	072200238
39	6	255	72,50	1	072200239
40	6,5	262	72,50	1	072200240
41	7	268	72,50	1	072200241
42	8	275	72,50	1	072200242
43	9	282	72,50	1	072200243
44	10	288	72,50	1	072200244
45	10,5	295	72,50	1	072200245
46	11	302	72,50	1	072200246
47	12	308	72,50	1	072200247
48	13	315	72,50	1	072200248

SUJEITO À DISPONIBILIDADE



CE

S3 SRC

EN ISO 20345 2011

METAL FREE



## 7221PEK

Botim em pele, impermeável, com aplicações de nylon, biqueira com reforço anti-abrasão e sistema de abertura rápida

- Biqueira em compósito
- Palmilha anti-perfuração em fibra reforçada

EU	UK	mm	€		
35	2,5	228	76,00	1	072210235
36	3,5	235	76,00	1	072210236
37	4,5	242	76,00	1	072210237
38	5	248	76,00	1	072210238
39	6	255	76,00	1	072210239
40	6,5	262	76,00	1	072210240
41	7	268	76,00	1	072210241
42	8	275	76,00	1	072210242
43	9	282	76,00	1	072210243
44	10	288	76,00	1	072210244
45	10,5	295	76,00	1	072210245
46	11	302	76,00	1	072210246
47	12	308	76,00	1	072210247
48	13	315	76,00	1	072210248

SUJEITO À DISPONIBILIDADE



CE

S3 RS SRC

EN ISO 20345 2011

METAL FREE



## 7222PEK

sapato em camurça, perfurado, com inserts de rede

- Biqueira em compósito
- Palmilha anti-perfuração em fibra compósita

EU	UK	mm	€		
35	2,5	228	70,00	1	072220135
36	3,5	235	70,00	1	072220136
37	4,5	242	70,00	1	072220137
38	5	248	70,00	1	072220138
39	6	255	70,00	1	072220139
40	6,5	262	70,00	1	072220140
41	7	268	70,00	1	072220141
42	8	275	70,00	1	072220142
43	9	282	70,00	1	072220143
44	10	288	70,00	1	072220144
45	10,5	295	70,00	1	072220145
46	11	302	70,00	1	072220146
47	12	308	70,00	1	072220147
48	13	315	70,00	1	072220148

SUJEITO À DISPONIBILIDADE



CE

S1P SRC

EN ISO 20345 2011

METAL FREE



## 7223PEK

Sapato de camurça com aberturas em rede e biqueira com reforço anti-abrasão

- Biqueira em compósito
- Palmilha anti-perfuração em fibra reforçada

**EN ISO  
20345  
2011**

METAL  
FREE



SUJEITO À DISPONIBILIDADE



S1P SRC

EU	UK	mm	€		
35	2,5	228	75,50	1	072230135
36	3,5	235	75,50	1	072230136
37	4,5	242	75,50	1	072230137
38	5	248	75,50	1	072230138
39	6	255	75,50	1	072230139
40	6,5	262	75,50	1	072230140
41	7	268	75,50	1	072230141
42	8	275	75,50	1	072230142
43	9	282	75,50	1	072230143
44	10	288	75,50	1	072230144
45	10,5	295	75,50	1	072230145
46	11	302	75,50	1	072230146
47	12	308	75,50	1	072230147
48	13	315	75,50	1	072230148

CE

## FLEX



## 7212B

sapato em camurça, perfurado, com inserções em rede, insert anti-abrasão na área da biqueira. Extraordinariamente flexível e leve - peso aprox. tamanho 42: 490 g - Não recomendado para trabalhos pesados (construção, agricultura, indústria pesada)

- Biqueira em material compósito
- Palmilha anti-perfuração em fibra compósita

**EN ISO  
20345  
2011**

ESD

METAL  
FREE



SUJEITO À DISPONIBILIDADE



S1P SRC ESD

EU	UK	mm	€		
35	2,5	228	81,00	1	072120235
36	3,5	235	81,00	1	072120236
37	4,5	242	81,00	1	072120237
38	5	248	81,00	1	072120238
39	6	255	81,00	1	072120239
40	6,5	262	81,00	1	072120240
41	7	268	81,00	1	072120241
42	8	275	81,00	1	072120242
43	9	282	81,00	1	072120243
44	10	288	81,00	1	072120244
45	10,5	295	81,00	1	072120245
46	11	302	81,00	1	072120246
47	12	308	81,00	1	072120247
48	13	315	81,00	1	072120248

CE



**Beta**



## 7212G

sapatos em camurça, perfurados. Com inserção anti-abrasão na biqueira. Extremamente maleáveis e leves - peso aprox. tamanho 42: 490 g Não recomendados para trabalhos pesados (construção, agricultura, indústria pesada)

- Biqueira em material compósito
- Palmilha anti-perfuração em fibra compósita

EU	UK	mm	€		
35	2,5	228	81,00	1	072120335
36	3,5	235	81,00	1	072120336
37	4,5	242	81,00	1	072120337
38	5	248	81,00	1	072120338
39	6	255	81,00	1	072120339
40	6,5	262	81,00	1	072120340
41	7	268	81,00	1	072120341
42	8	275	81,00	1	072120342
43	9	282	81,00	1	072120343
44	10	288	81,00	1	072120344
45	10,5	295	81,00	1	072120345
46	11	302	81,00	1	072120346
47	12	308	81,00	1	072120347
48	13	315	81,00	1	072120348

CE

SUJEITO À DISPONIBILIDADE



S1P SRC ESD



EN ISO 20345 2011



## 7213G

sapato em camurça, perfurado, com inserções em rede altamente respiráveis. Extraordinariamente flexíveis e leves - peso aprox. para tamanho 42: 490 g Não recomendado para trabalhos pesados (construção, agricultura, indústria pesada)

- Biqueira em material compósito
- Palmilha anti-perfuração em fibra compósita

EU	UK	mm	€		
35	2,5	228	81,00	1	072130135
36	3,5	235	81,00	1	072130136
37	4,5	242	81,00	1	072130137
38	5	248	81,00	1	072130138
39	6	255	81,00	1	072130139
40	6,5	262	81,00	1	072130140
41	7	268	81,00	1	072130141
42	8	275	81,00	1	072130142
43	9	282	81,00	1	072130143
44	10	288	81,00	1	072130144
45	10,5	295	81,00	1	072130145
46	11	302	81,00	1	072130146
47	12	308	81,00	1	072130147
48	13	315	81,00	1	072130148

CE

SUJEITO À DISPONIBILIDADE



S1P SRC ESD



EN ISO 20345 2011



## 7214FN

Sapato em pele, impermeável, com proteção anti-abrasão na biqueira. Extremamente leve e flexível - peso aproximado 500g, tamanho 42 Não recomendado para trabalhos pesados (construção, agricultura, indústria)

- Biqueira em compósito
- Sola intermédia antiperfuração em fibra compósita

EU	UK	mm	€		
35	2,5	228	87,50	1	072140035
36	3,5	235	87,50	1	072140036
37	4,5	242	87,50	1	072140037
38	5	248	87,50	1	072140038
39	6	255	87,50	1	072140039
40	6,5	262	87,50	1	072140040
41	7	268	87,50	1	072140041
42	8	275	87,50	1	072140042
43	9	282	87,50	1	072140043
44	10	288	87,50	1	072140044
45	10,5	295	87,50	1	072140045
46	11	302	87,50	1	072140046
47	12	308	87,50	1	072140047
48	13	315	87,50	1	072140048

CE

SUJEITO À DISPONIBILIDADE



S3 SRC



EN ISO 20345 2011



 **Beta**



## 72146

sapatos Action em camurça, impermeáveis, com insert anti-abrasão na área da biqueira Extraordinariamente flexíveis e leves -peso aprox. para o tamanho 42: 500 g Não recomendado para trabalhos pesados (construção, agricultura, indústria pesada)

- Biqueira em material compósito
- Palmilha anti-perfuração em fibra compósita

EU	UK	mm	€		
35	2,5	228	87,50	1	072140235
36	3,5	235	87,50	1	072140236
37	4,5	242	87,50	1	072140237
38	5	248	87,50	1	072140238
39	6	255	87,50	1	072140239
40	6,5	262	87,50	1	072140240
41	7	268	87,50	1	072140241
42	8	275	87,50	1	072140242
43	9	282	87,50	1	072140243
44	10	288	87,50	1	072140244
45	10,5	295	87,50	1	072140245
46	11	302	87,50	1	072140246
47	12	308	87,50	1	072140247
48	13	315	87,50	1	072140248

SUJEITO À DISPONIBILIDADE



EN ISO 20345 2011



S3 SRC ESD

CE

## 7215FN

mocasin Action em pele Nubuck, impermeáveis, com aplicação anti-abrasão na biqueira Extremamente leve e flexível - peso aproximado 490g, tamanho 42 Não recomendado para trabalhos pesados (construção, agricultura, indústria)

- Biqueira em material compósito
- Sola intermédia anti-perfuração em fibra compósita

EU	UK	mm	€		
35	2,5	228	88,50	1	072150135
36	3,5	235	88,50	1	072150136
37	4,5	242	88,50	1	072150137
38	5	248	88,50	1	072150138
39	6	255	88,50	1	072150139
40	6,5	262	88,50	1	072150140
41	7	268	88,50	1	072150141
42	8	275	88,50	1	072150142
43	9	282	88,50	1	072150143
44	10	288	88,50	1	072150144
45	10,5	295	88,50	1	072150145
46	11	302	88,50	1	072150146
47	12	308	88,50	1	072150147
48	13	315	88,50	1	072150148

SUJEITO À DISPONIBILIDADE



EN ISO 20345 2011



S3 SRC

CE

## 7218FN

Botim em Nubuck, impermeável, biqueira anti-abrasão e sistema de abertura rápida. Extremamente flexível e leve - peso apróx., tamanho 42: 510g. Não recomendado para trabalhos pesados (ex: construção, agricultura, indústria pesada).

- Biqueira em compósito
- Palmilha anti-perfuração em fibra reforçada

EU	UK	mm	€		
35	2,5	228	91,50	1	072180035
36	3,5	235	91,50	1	072180036
37	4,5	242	91,50	1	072180037
38	5	248	91,50	1	072180038
39	6	255	91,50	1	072180039
40	6,5	262	91,50	1	072180040
41	7	268	91,50	1	072180041
42	8	275	91,50	1	072180042
43	9	282	91,50	1	072180043
44	10	288	91,50	1	072180044
45	10,5	295	91,50	1	072180045
46	11	302	91,50	1	072180046
47	12	308	91,50	1	072180047
48	13	315	91,50	1	072180048

SUJEITO À DISPONIBILIDADE



EN ISO 20345 2011



S3 RS SRC

CE

## 7218G

botins Action em camurça, impermeáveis, com insert anti-abrasão na área da biqueira e sistema de abertura rápida Extraordinariamente flexíveis e leves -peso aprox. para o tamanho 42: 550 g Não recomendado para trabalhos pesados (construção, agricultura, indústria pesada)

- Biqueira em material compósito
- Palmilha anti-perfuração em fibra compósita

EU	UK	mm	€		
35	2,5	228	91,50	1	072180135
36	3,5	235	91,50	1	072180136
37	4,5	242	91,50	1	072180137
38	5	248	91,50	1	072180138
39	6	255	91,50	1	072180139
40	6,5	262	91,50	1	072180140
41	7	268	91,50	1	072180141
42	8	275	91,50	1	072180142
43	9	282	91,50	1	072180143
44	10	288	91,50	1	072180144
45	10,5	295	91,50	1	072180145
46	11	302	91,50	1	072180146
47	12	308	91,50	1	072180147
48	13	315	91,50	1	072180148

SUJEITO À DISPONIBILIDADE



EN ISO 20345 2011



S3 RS SRC ESD

CE



## 7316NB

sapato em camurça e rede, altamente respirável, com apoio de estabilidade no calcanhar

- Biqueira em composto
- Palmilha anti-perfuração em fibra composta

EU	UK	mm	€		
35	2,5	228	96,00	1	073160735
36	3,5	235	96,00	1	073160736
37	4,5	242	96,00	1	073160737
38	5	248	96,00	1	073160738
39	6	255	96,00	1	073160739
40	6,5	262	96,00	1	073160740
41	7	268	96,00	1	073160741
42	8	275	96,00	1	073160742
43	9	282	96,00	1	073160743
44	10	288	96,00	1	073160744
45	10,5	295	96,00	1	073160745
46	11	302	96,00	1	073160746
47	12	308	96,00	1	073160747
48	13	315	96,00	1	073160748

CE



EN ISO 20345 2011



S1P SRC ESD

## 7316NG

sapato em camurça e rede, altamente respirável, com apoio de estabilidade no calcanhar

- Biqueira em composto
- Palmilha anti-perfuração em fibra composta

EU	UK	mm	€		
35	2,5	228	96,00	1	073160635
36	3,5	235	96,00	1	073160636
37	4,5	242	96,00	1	073160637
38	5	248	96,00	1	073160638
39	6	255	96,00	1	073160639
40	6,5	262	96,00	1	073160640
41	7	268	96,00	1	073160641
42	8	275	96,00	1	073160642
43	9	282	96,00	1	073160643
44	10	288	96,00	1	073160644
45	10,5	295	96,00	1	073160645
46	11	302	96,00	1	073160646
47	12	308	96,00	1	073160647
48	13	315	96,00	1	073160648

CE



S1P SRC ESD

## 7317NA

Sapato de camurça, perfurado, com reforço de microfibras na zona do calcanhar

- Biqueira em composto
- Palmilha anti-perfuração em fibra composta

EU	UK	mm	€		
35	2,5	228	82,50	1	073170135
36	3,5	235	82,50	1	073170136
37	4,5	242	82,50	1	073170137
38	5	248	82,50	1	073170138
39	6	255	82,50	1	073170139
40	6,5	262	82,50	1	073170140
41	7	268	82,50	1	073170141
42	8	275	82,50	1	073170142
43	9	282	82,50	1	073170143
44	10	288	82,50	1	073170144
45	10,5	295	82,50	1	073170145
46	11	302	82,50	1	073170146
47	12	308	82,50	1	073170147
48	13	315	82,50	1	073170148

CE



EN ISO 20345 2011



S1P SRC



## 7320NA

sapato em microfibra, impermeável, com reforço antiabrasão na biqueira e apoio de estabilidade no calcanhar

- Biqueira em compósito
- Palmilha anti-perfuração em fibra compósita

EU	UK	mm	€		
35	2,5	228	87,00	1	073200535
36	3,5	235	87,00	1	073200536
37	4,5	242	87,00	1	073200537
38	5	248	87,00	1	073200538
39	6	255	87,00	1	073200539
40	6,5	262	87,00	1	073200540
41	7	268	87,00	1	073200541
42	8	275	87,00	1	073200542
43	9	282	87,00	1	073200543
44	10	288	87,00	1	073200544
45	10,5	295	87,00	1	073200545
46	11	302	87,00	1	073200546
47	12	308	87,00	1	073200547
48	13	315	87,00	1	073200548

CE



S3 SRC

EN ISO 20345 2011

METAL FREE



## 7321NA

botim em microfibra, impermeável, com sistema de abertura rápida, reforço antiabrasão na biqueira e apoio de estabilidade no calcanhar

- Biqueira em compósito
- Palmilha anti-perfuração em fibra compósita

EU	UK	mm	€		
35	2,5	228	89,50	1	073210535
36	3,5	235	89,50	1	073210536
37	4,5	242	89,50	1	073210537
38	5	248	89,50	1	073210538
39	6	255	89,50	1	073210539
40	6,5	262	89,50	1	073210540
41	7	268	89,50	1	073210541
42	8	275	89,50	1	073210542
43	9	282	89,50	1	073210543
44	10	288	89,50	1	073210544
45	10,5	295	89,50	1	073210545
46	11	306	89,50	1	073210546
47	12	308	89,50	1	073210547
48	13	315	89,50	1	073210548

CE



S3 RS SRC

EN ISO 20345 2011

METAL FREE



## 7322SA

sapato em tecido, elevada resistência à abrasão, com suporte à estabilidade do calcanhar

- Biqueira em compósito
- Palmilha anti-perfuração em fibra compósita

EU	UK	mm	€		
35	2,5	228	94,00	1	073220435
36	3,5	235	94,00	1	073220436
37	4,5	242	94,00	1	073220437
38	5	248	94,00	1	073220438
39	6	255	94,00	1	073220439
40	6,5	262	94,00	1	073220440
41	7	268	94,00	1	073220441
42	8	275	94,00	1	073220442
43	9	282	94,00	1	073220443
44	10	288	94,00	1	073220444
45	10,5	295	94,00	1	073220445
46	11	302	94,00	1	073220446
47	12	308	94,00	1	073220447
48	13	315	94,00	1	073220448

CE



S3 SRC

EN ISO 20345 2011

METAL FREE



## 7323SA

botim em tecido, elevada resistência à abrasão, com sistema de abertura rápida e suporte à estabilidade do calcanhar

- Biqueira em compósito
- Palmilha anti-perfuração em fibra compósita

EU	UK	mm	€		
35	2,5	228	96,50	1	073230435
36	3,5	235	96,50	1	073230436
37	4,5	242	96,50	1	073230437
38	5	248	96,50	1	073230438
39	6	255	96,50	1	073230439
40	6,5	262	96,50	1	073230440
41	7	268	96,50	1	073230441
42	8	275	96,50	1	073230442
43	9	282	96,50	1	073230443
44	10	288	96,50	1	073230444
45	10,5	295	96,50	1	073230445
46	11	302	96,50	1	073230446
47	12	308	96,50	1	073230447
48	13	315	96,50	1	073230448

CE



S3 RS SRC

EN ISO 20345 2011

METAL FREE







## 7352B

sapato em tecido respirável, com aplicações em TPU  
Apoio de estabilidade do calcanhar, rebordo elástico, e sola em borracha nitrílica resistente EVA

- Biqueira em material compósito
- Palmilha anti-perfuração em fibra compósita
- EXTREMAMENTE LEVE: peso aproximado, tamanho 42: 450 g

**EN ISO  
20345  
2011**

EU	UK	mm	€	W	L
38	5	254	144,00	1	073520138
39	6	261	144,00	1	073520139
40	6,5	268	144,00	1	073520140
41	7	274	144,00	1	073520141
42	8	281	144,00	1	073520142
43	9	288	144,00	1	073520143
44	10	294	144,00	1	073520144
45	10,5	301	144,00	1	073520145
46	11	308	144,00	1	073520146
47	12	314	144,00	1	073520147
48	13	321	144,00	1	073520148



METAL  
FREE



CE

S1P HRO SRC

## 7352G

sapato em tecido de malha de rede altamente respirável, com inserts TPU  
suporte à estabilidade do calcanhar, com atacadores, pé largo.  
sola EVA com rasto em borracha nitrílica

- Biqueira em material compósito
- Palmilha anti-perfuração em fibra compósita
- EXTREMAMENTE LEVE: peso aproximado tamanho 42: 450 gramas

**EN ISO  
20345  
2011**

EU	UK	mm	€	W	L
38	5	254	149,00	1	073520338
39	6	261	149,00	1	073520339
40	6,5	268	149,00	1	073520340
41	7	274	149,00	1	073520341
42	8	281	149,00	1	073520342
43	9	288	149,00	1	073520343
44	10	294	149,00	1	073520344
45	10,5	301	149,00	1	073520345
46	11	308	149,00	1	073520346
47	12	314	149,00	1	073520347
48	13	321	149,00	1	073520348



METAL  
FREE



CE

S1P HRO SRC ESD

## 7352LG

sapato de senhora em tecido de malha de rede, altamente respirável, com aplicações em TPU  
gáspea com malha refletora de alta visibilidade  
suporte à estabilidade do calcanhar, rebordo elástico no tornozelo  
e sola em EVA com rasto em borracha nitrílica

- Biqueira em fibra de vidro
- Palmilha anti-perfuração em fibra compósita
- EXTREMAMENTE LEVE: peso aproximado tamanho 38: 390 gramas

**EN ISO  
20345  
2011**

EU	UK	mm	€	W	L
34	2	228	149,00	1	073520234
35	2,5	234	149,00	1	073520235
36	3,5	241	149,00	1	073520236
37	4,5	248	149,00	1	073520237
38	5	254	149,00	1	073520238
39	6	261	149,00	1	073520239
40	6,5	268	149,00	1	073520240
41	7	274	149,00	1	073520241
42	8	281	149,00	1	073520242



METAL  
FREE



CE

S1P HRO SRC

## 7354N

sapato em tecido, impermeável, com aplicações em TPU  
Apoio de estabilidade do calcanhar, rebordo elástico, e sola em borracha nitrílica resistente EVA

- Biqueira em material compósito
- Palmilha anti-perfuração em fibra compósita
- EXTREMAMENTE LEVE: peso aproximado, tamanho 42: 460 g

**EN ISO  
20345  
2011**

EU	UK	mm	€		
38	5	254	149,00	1	073540038
39	6	261	149,00	1	073540039
40	6,5	268	149,00	1	073540040
41	7	274	149,00	1	073540041
42	8	281	149,00	1	073540042
43	9	288	149,00	1	073540043
44	10	294	149,00	1	073540044
45	10,5	301	149,00	1	073540045
46	11	308	149,00	1	073540046
47	12	314	149,00	1	073540047
48	13	321	149,00	1	073540048



METAL  
FREE



CE

S3 HRO SRC

## 7356G

sapato em microfibras, impermeável, com aplicações em TPU.  
Apoio de estabilidade no calcanhar, rebordo elástico e sola em EVA com rastro resistente em borracha nitrílica.

- Biqueira em material compósito
- Palmilha anti-perfuração em fibra compósita
- EXTREMAMENTE LEVE: peso aproximado para tamanho 42: 460 g

**EN ISO  
20345  
2011**

EU	UK	mm	€		
38	5	254	154,00	1	073560038
39	6	261	154,00	1	073560039
40	6,5	268	154,00	1	073560040
41	7	274	154,00	1	073560041
42	8	281	154,00	1	073560042
43	9	288	154,00	1	073560043
44	10	294	154,00	1	073560044
45	10,5	301	154,00	1	073560045
46	11	308	154,00	1	073560046
47	12	314	154,00	1	073560047
48	13	321	154,00	1	073560048



METAL  
FREE



CE

S3 HRO SRC

## 7356V

sapato em microfibras, impermeável, com aplicações em TPU  
suporte à estabilidade do calcanhar, rebordo elástico no tornozelo  
e sola em EVA com rasto em borracha nitrílica

- Biqueira em compósito
  - Palmilha anti-perfuração em fibra compósita
  - EXTREMAMENTE LEVE: peso aproximado tamanho 42: 460 gramas
- SUJEITO À DISPONIBILIDADE**

**EN ISO  
20345  
2011**

EU	UK	mm	€		
38	5	254	154,00	1	073560138
39	6	261	154,00	1	073560139
40	6,5	268	154,00	1	073560140
41	7	274	154,00	1	073560141
42	8	281	154,00	1	073560142
43	9	288	154,00	1	073560143
44	10	294	154,00	1	073560144
45	10,5	301	154,00	1	073560145
46	11	308	154,00	1	073560146
47	12	314	154,00	1	073560147
48	13	321	154,00	1	073560148



METAL  
FREE



CE

S3 HRO SRC

## 7356LN

sapato de senhora em microfibras, impermeável, com aplicações em TPU  
suporte à estabilidade do calcanhar, rebordo elástico no tornozelo  
e sola em EVA com rasto em borracha nitrílica

- Biqueira em fibra de vidro
- Palmilha anti-perfuração em fibra compósita
- EXTREMAMENTE LEVE: peso aproximado tamanho 38: 400 gramas

**EN ISO  
20345  
2011**

EU	UK	mm	€		
34	2	228	153,00	1	073560234
35	2,5	234	153,00	1	073560235
36	3,5	241	153,00	1	073560236
37	4,5	248	153,00	1	073560237
38	5	254	153,00	1	073560238
39	6	261	153,00	1	073560239
40	6,5	268	153,00	1	073560240
41	7	274	153,00	1	073560241
42	8	281	153,00	1	073560242



METAL  
FREE



CE

S3 HRO SRC



## 7357G

botim em microfibra, impermeável, aplicações em TPU  
 Apoio de estabilidade no calcanhar, rebordo elástico e sola em EVA com rastro em borracha nitrilica

- Biqueira em material compósito
- Palmilha anti-perfuração em fibra compósito
- EXTREMAMENTE LEVE: peso aproximado para tamanho 42: 480 g

**EN ISO  
20345  
2011**

EU	UK	mm	€		
38	5	254	170,00	1	073570038
39	6	261	170,00	1	073570039
40	6,5	268	170,00	1	073570040
41	7	274	170,00	1	073570041
42	8	281	170,00	1	073570042
43	9	288	170,00	1	073570043
44	10	294	170,00	1	073570044
45	10,5	301	170,00	1	073570045
46	11	308	170,00	1	073570046
47	12	314	170,00	1	073570047
48	13	321	170,00	1	073570048



CE

S3 HRO SRC

METAL  
FREE



## 7357V

botim em microfibra, impermeável, com aplicações em TPU  
 suporte à estabilidade do calcanhar, rebordo elástico no tornozelo  
 e sola em EVA com rastro em borracha nitrilica

- Biqueira em compósito
- Palmilha anti-perfuração em fibra compósito
- EXTREMAMENTE LEVE: peso aproximado tamanho 42: 480 gramas

**EN ISO  
20345  
2011**

EU	UK	mm	€		
38	5	254	170,00	1	073570138
39	6	261	170,00	1	073570139
40	6,5	268	170,00	1	073570140
41	7	274	170,00	1	073570141
42	8	281	170,00	1	073570142
43	9	288	170,00	1	073570143
44	10	294	170,00	1	073570144
45	10,5	301	170,00	1	073570145
46	11	308	170,00	1	073570146
47	12	314	170,00	1	073570147
48	13	321	170,00	1	073570148



CE

S3 HRO SRC

SUJEITO À  
DISPONIBILIDADE

METAL  
FREE



## 7362B

sapatos de trabalho, em tecido de malha muito respirável, com aplicações em TPU.  
 Apoio de estabilidade para o calcanhar, rebordo elástico e sola em borracha nitrilica resistente EVA

- Sem biqueira
- Sem sola intermédia anti-perfuração
- EXTRAORDINARIAMENTE LEVES: peso aprox. tamanho 42: 330 gramas

**EN ISO  
20347  
2012**

EU	UK	mm	€		
39	6	261	131,00	1	073620039
40	6,5	268	131,00	1	073620040
41	7	274	131,00	1	073620041
42	8	281	131,00	1	073620042
43	9	288	131,00	1	073620043
44	10	294	131,00	1	073620044
45	10,5	301	131,00	1	073620045
46	11	308	131,00	1	073620046
47	12	314	131,00	1	073620047
48	13	321	131,00	1	073620048



CE

01 FO HRO SRC

SUJEITO À  
DISPONIBILIDADE

METAL  
FREE



## 7363N

sapato de trabalho em tecido de malha, impermeável, com aplicações em TPU.  
 Apoio de estabilidade para o calcanhar, rebordo elástico e sola em borracha nitrilica resistente EVA

- Sem biqueira
- Sem sola intermédia anti-perfuração
- EXTRAORDINARIAMENTE LEVES: peso aprox. tamanho 42: 330 gramas

**EN ISO  
20347  
2012**

EU	UK	mm	€		
39	6	261	136,00	1	073630039
40	6,5	268	136,00	1	073630040
41	7	274	136,00	1	073630041
42	8	281	136,00	1	073630042
43	9	288	136,00	1	073630043
44	10	294	136,00	1	073630044
45	10,5	301	136,00	1	073630045
46	11	308	136,00	1	073630046
47	12	314	136,00	1	073630047
48	13	321	136,00	1	073630048



CE

02 FO HRO SRC

METAL  
FREE





## 7371V

sapato em tecido, ultra-respirável.

Com apoio de estabilidade no calcanhar, atacadores tradicionais, modelo largo.

Sola EVA com rasto durável em borracha de nitrilo.

- Biqueira em material compósito
- Palmilha anti-perfuração em fibra compósita
- EXTREMAMENTE LEVE: peso aproximado, tamanho 42: 450 g

EN ISO 20345 2022

EU	UK	mm	€		
38	5	254	149,00	1	073710038
39	6	261	149,00	1	073710039
40	6,5	268	149,00	1	073710040
41	7	274	149,00	1	073710041
42	8	281	149,00	1	073710042
43	9	288	149,00	1	073710043
44	10	294	149,00	1	073710044
45	10,5	301	149,00	1	073710045
46	11	308	149,00	1	073710046
47	12	314	149,00	1	073710047
48	13	321	149,00	1	073710048

CE



S1PS HRO FO SR ESD



## 7372B

sapatos em tecido, ultra-resistentes e ultra-respiráveis.

Com apoio de estabilidade no calcanhar, atacadores tradicionais, modelo largo.

Sola EVA com rasto durável em borracha de nitrilo.

- Biqueira em compósito
- Palmilha anti-perfuração em fibra compósita
- INCRIVELMENTE LEVES: peso aprox. tamanho 42: 450 g

EN ISO 20345 2011

EU	UK	mm	€		
38	5	254	153,00	1	073720038
39	6	261	153,00	1	073720039
40	6,5	268	153,00	1	073720040
41	7	274	153,00	1	073720041
42	8	281	153,00	1	073720042
43	9	288	153,00	1	073720043
44	10	294	153,00	1	073720044
45	10,5	301	153,00	1	073720045
46	11	308	153,00	1	073720046
47	12	314	153,00	1	073720047
48	13	321	153,00	1	073720048

CE



S1P HRO SRC



## 7376A

sapatos com aberturas, em microfibra e rede, perfurados e altamente respiráveis

Com apoio de estabilidade no calcanhar, atacadores tradicionais com elasticidade, modelo largo.

Sola EVA com rasto durável em borracha de nitrilo.

- Biqueira em compósito
- Palmilha anti-perfuração em fibra compósita
- INCRIVELMENTE LEVES: peso aprox. tamanho 42: 490 g

EN ISO 20345 2011

EU	UK	mm	€		
39	6	261	155,00	1	073760039
40	6,5	268	155,00	1	073760040
41	7	274	155,00	1	073760041
42	8	281	155,00	1	073760042
43	9	288	155,00	1	073760043
44	10	294	155,00	1	073760044
45	10,5	301	155,00	1	073760045
46	11	308	155,00	1	073760046
47	12	314	155,00	1	073760047
48	13	321	155,00	1	073760048

CE

SUJEITO À DISPONIBILIDADE



S1P HRO SRC



## 7381N

sapatos impermeáveis, em tecido altamente resistente à abrasão, com inserções em TPU. Suporte de estabilidade no calcanhar, atacadores tradicionais, modelo largo. Sola de EVA com rasto em borracha nitrílica durável.

- Biqueira composta
- Palmilha anti-perfuração em fibra composta
- Membrana impermeabilizante Beta TECH, com sistema bootie
- LEVE: peso aproximado para tamanho 42: 500 g

EN ISO 20345 2011

EU	UK	mm	€		
38	5	254	177,00	1	073810038
39	6	261	177,00	1	073810039
40	6,5	268	177,00	1	073810040
41	7	274	177,00	1	073810041
42	8	281	177,00	1	073810042
43	9	288	177,00	1	073810043
44	10	294	177,00	1	073810044
45	10,5	301	177,00	1	073810045
46	11	308	177,00	1	073810046
47	12	314	177,00	1	073810047
48	13	321	177,00	1	073810048

CE



S3 SRC HRO WR



## 7382N

sapatos impermeáveis, em tecido altamente resistente à abrasão, com inserções em TPU. Suporte de estabilidade no calcanhar, atacadores tradicionais, modelo largo. Sola de EVA com rasto em borracha nitrílica durável.

- Biqueira composta
- Palmilha anti-perfuração em fibra composta
- Membrana impermeabilizante Beta TECH, com sistema bootie
- LEVE: peso aproximado para tamanho 42: 500 g

**EN ISO  
20345  
2011**



CE

S3 SRC HRO WR

EU	UK	mm	€		
38	5	254	198,00	1	073820038
39	6	261	198,00	1	073820039
40	6,5	268	198,00	1	073820040
41	7	274	198,00	1	073820041
42	8	281	198,00	1	073820042
43	9	288	198,00	1	073820043
44	10	294	198,00	1	073820044
45	10,5	301	198,00	1	073820045
46	11	308	198,00	1	073820046
47	12	314	198,00	1	073820047
48	13	321	198,00	1	073820048

## FitEvolution

A gama de calçado de segurança, Beta FitEvolution, é composta por 7 modelos de design único, disponíveis em diversas cores e materiais. A sua característica revolucionária reside no inovador sistema patenteado Fit4You, baseado em tecnologia de ponta que permite um conforto e suporte personalizados de acordo com a altura, o peso e as necessidades individuais de trabalho. Cada pack inclui três inserts de ETPU – SUAVE, MÉDIO e DURO -, que permitem adaptar perfeitamente o calçado ao grau de suavidade pretendido, proporcionando um conforto personalizado para cada situação.



## 7270Y

sapato em rede FitEVOLUTION, altamente respirável, com sistema de personalização de calçado patenteado FIT 4 YOU. Apoio de estabilidade no calcanhar e atacador tradicional. Sola de poliuretano de dupla densidade

- biqueira em material compósito
- palmilha antiperfuração em fibra compósita
- 3 inserts ETPU de 3 densidades para um sapato personalizado

**EN ISO  
20345  
2022**



FIT4YOU



CE

S1PS FO SR ESD

EU	UK	mm	€		
37	4,5	251	162,00	1	072700137
38	5	257	162,00	1	072700138
39	6	263	162,00	1	072700139
40	6,5	269	162,00	1	072700140
41	7	276	162,00	1	072700141
42	8	282	162,00	1	072700142
43	9	290	162,00	1	072700143
44	10	296	162,00	1	072700144
45	10,5	304	162,00	1	072700145
46	11	311	162,00	1	072700146
47	12	317	162,00	1	072700147
48	13	324	162,00	1	072700148

## 7271V

sapato em camurça FitEVOLUTION, perfurado, com sistema de personalização de calçado patenteado FIT 4 YOU. Apoio de estabilidade no calcanhar e atacador tradicional. Sola de poliuretano de dupla densidade

- biqueira em material compósito
- palmilha antiperfuração em fibra compósita
- 3 inserts ETPU de 3 densidades para um sapato personalizado

**EN ISO  
20345  
2022**



FIT4YOU



CE

S1PS FO SR ESD

EU	UK	mm	€		
37	4,5	251	162,00	1	072710137
38	5	257	162,00	1	072710138
39	6	263	162,00	1	072710139
40	6,5	269	162,00	1	072710140
41	7	276	162,00	1	072710141
42	8	282	162,00	1	072710142
43	9	290	162,00	1	072710143
44	10	296	162,00	1	072710144
45	10,5	304	162,00	1	072710145
46	11	311	162,00	1	072710146
47	12	317	162,00	1	072710147
48	13	324	162,00	1	072710148



## 7272V

sapato em tecido FitEVOLUTION, resistente e altamente respirável, com sistema de personalização de calçado patenteado FIT 4 YOU.

Apoio de estabilidade no calcanhar e atacador tradicional.

Sola de poliuretano de dupla densidade

EU	UK	mm	€		
37	4,5	251	162,00	1	072720137
38	5	257	162,00	1	072720138
39	6	263	162,00	1	072720139
40	6,5	269	162,00	1	072720140
41	7	276	162,00	1	072720141
42	8	282	162,00	1	072720142
43	9	290	162,00	1	072720143
44	10	296	162,00	1	072720144
45	10,5	304	162,00	1	072720145
46	11	311	162,00	1	072720146
47	12	317	162,00	1	072720147
48	13	324	162,00	1	072720148

CE

FIT4YOU



S1PS FO SR ESD

- biqueira em material compósito
- palmilha antiperfuração em fibra compósita
- 3 inserts ETPU de 3 densidades para um sapato personalizado



EN ISO 20345 2022



## 7273G

sapato em nubuck FitEVOLUTION, impermeável, com sistema de personalização de calçado patenteado FIT 4 YOU.

Apoio de estabilidade no calcanhar e atacador tradicional.

Sola de poliuretano de dupla densidade

EU	UK	mm	€		
37	4,5	251	166,00	1	072730137
38	5	257	166,00	1	072730138
39	6	263	166,00	1	072730139
41	7	276	166,00	1	072730141
40	6,5	269	166,00	1	072730140
42	8	282	166,00	1	072730142
43	9	290	166,00	1	072730143
44	10	296	166,00	1	072730144
45	10,5	304	166,00	1	072730145
46	11	311	166,00	1	072730146
47	12	317	166,00	1	072730147
48	13	324	166,00	1	072730148

CE

FIT4YOU



S3S FO SR ESD

- biqueira em material compósito
- palmilha antiperfuração em fibra compósita
- 3 inserts ETPU de 3 densidades para um sapato personalizado



EN ISO 20345 2022



## 7274G

botim em nubuck FitEVOLUTION, impermeável, com sistema de personalização de calçado patenteado FIT 4 YOU.

Apoio de estabilidade no calcanhar e atacador tradicional.

Sola de poliuretano de dupla densidade

EU	UK	mm	€		
37	4,5	251	172,00	1	072740237
38	5	257	172,00	1	072740238
39	6	263	172,00	1	072740239
40	6,5	269	172,00	1	072740240
41	7	276	172,00	1	072740241
42	8	282	172,00	1	072740242
43	9	290	172,00	1	072740243
44	10	296	172,00	1	072740244
45	10,5	304	172,00	1	072740245
46	11	311	172,00	1	072740246
47	12	317	172,00	1	072740247
48	13	324	172,00	1	072740248

CE

FIT4YOU



S3S FO SR ESD

- biqueira em material compósito
- palmilha antiperfuração em fibra compósita
- 3 inserts ETPU de 3 densidades para um sapato personalizado



EN ISO 20345 2022



## 7275N

sapato em microfibras FitEVOLUTION, impermeável, com sistema de personalização de calçado patenteado FIT 4 YOU.

Apoio de estabilidade no calcanhar e atacador tradicional.

Sola de poliuretano de dupla densidade

EU	UK	mm	€		
37	4,5	251	166,00	1	072750237
38	5	257	166,00	1	072750238
39	6	263	166,00	1	072750239
40	6,5	269	166,00	1	072750240
41	7	276	166,00	1	072750241
42	8	282	166,00	1	072750242
43	9	290	166,00	1	072750243
44	10	296	166,00	1	072750244
45	10,5	304	166,00	1	072750245
46	11	311	166,00	1	072750246
47	12	317	166,00	1	072750247
48	13	324	166,00	1	072750248

CE

FIT4YOU



S3S FO SR ESD

- biqueira em material compósito
- palmilha antiperfuração em fibra compósita
- 3 inserts ETPU de 3 densidades para um sapato personalizado



EN ISO 20345 2022





## 7276N

botim em microfibras FitEVOLUTION, impermeável, com sistema de personalização de calçado patenteado FIT 4 YOU. Apoio de estabilidade no calcanhar e atacador tradicional. Sola de poliuretano de dupla densidade

- biqueira em material compósito
- palmilha antiperfuração em fibra compósita
- 3 inserts ETPU de 3 densidades para um sapato personalizado

FIT4YOU

EN ISO  
20345  
2022



EU	UK	mm	€		
37	4,5	251	172,00	1	072760237
38	5	257	172,00	1	072760238
39	6	263	172,00	1	072760239
40	6,5	269	172,00	1	072760240
41	7	276	172,00	1	072760241
42	8	282	172,00	1	072760242
43	9	290	172,00	1	072760243
44	10	296	172,00	1	072760244
45	10,5	304	172,00	1	072760245
46	11	311	172,00	1	072760246
47	12	317	172,00	1	072760247
48	13	324	172,00	1	072760248

CE



S3S FO SR ESD

## RENEGADE

A nova linha de calçado de segurança, Renegade, foi concebida para oferecer segurança e estilo. A linha Renegade combina proteção com um aspeto moderno e cativante. A gama, composta por 6 modelos em cores e materiais únicos, adapta-se perfeitamente a quem quer destacar-se em qualquer ambiente de trabalho. A Renegade conta com um design inspirado no calçado desportivo de última geração, um amortecimento superior e um suporte notável para proporcionar conforto durante todo o dia. O corpo largo - 11 - garante caminhadas suaves e confortáveis, sem comprimir o pé. Baseado num estilo arrojado e pouco convencional, a Renegade é a escolha ideal para os profissionais modernos.

O modelo 7340VA é o primeiro calçado da Beta equipado com um sistema de atacadores rápidos.



## 7340VA

sapato em tecido de malha de rede RENEGADE, altamente respirável, com atacadores rápidos ATOP. Suporte à estabilidade do calcanhar. Sola em EVA com rasto de borracha nitrílica. Modelo largo

- biqueira em material compósito
- palmilha anti-perfuração em fibra compósita

EN ISO  
20345  
2022



EU	UK	mm	€		
37	4,5	248	187,00	1	073400537
38	5	254	187,00	1	073400538
39	6	261	187,00	1	073400539
40	6,5	268	187,00	1	073400540
41	7	274	187,00	1	073400541
42	8	281	187,00	1	073400542
43	9	288	187,00	1	073400543
44	10	294	187,00	1	073400544
45	10,5	301	187,00	1	073400545
46	11	308	187,00	1	073400546
47	12	314	187,00	1	073400547
48	13	321	187,00	1	073400548

CE



S1PS FO SR HRO

## 7340G

sapato em tecido de malha de rede RENEGADE, altamente respirável. Suporte à estabilidade do calcanhar. Sola em EVA com rasto de borracha nitrílica. Atacadores tradicionais. Modelo largo

- biqueira em material compósito
- palmilha anti-perfuração em fibra compósita

EN ISO  
20345  
2022



EU	UK	mm	€		
37	4,5	248	152,00	1	073400637
38	5	254	152,00	1	073400638
39	6	261	152,00	1	073400639
40	6,5	268	152,00	1	073400640
41	7	274	152,00	1	073400641
42	8	281	152,00	1	073400642
43	9	288	152,00	1	073400643
44	10	294	152,00	1	073400644
45	10,5	301	152,00	1	073400645
46	11	308	152,00	1	073400646
47	12	314	152,00	1	073400647
48	13	321	152,00	1	073400648

CE



S1PS FO SR HRO

## 7341V

sapato em tecido RENEGADE, resistente e ultra-respirável. Suporte à estabilidade do calcanhar. Sola em EVA com rasto em borracha nitrílica. Atacadores tradicionais. Modelo largo

- biqueira em material compósito
- palmilha anti-perfuração em fibra compósita

**EN ISO  
20345  
2022**

EU	UK	mm	€		
37	4.5	248	160,00	1	073410537
38	5	254	160,00	1	073410538
39	6	261	160,00	1	073410539
40	6.5	268	160,00	1	073410540
41	7	274	160,00	1	073410541
42	8	281	160,00	1	073410542
43	9	288	160,00	1	073410543
44	10	294	160,00	1	073410544
45	10.5	301	160,00	1	073410545
46	11	308	160,00	1	073410546
47	12	314	160,00	1	073410547
48	13	321	160,00	1	073410548



METAL  
FREE



S1PS FO SR HRO

CE

## 7341Y

sapato em tecido RENEGADE, resistente e ultra-respirável. Suporte à estabilidade do calcanhar. Sola em EVA com rasto em borracha nitrílica. Atacadores tradicionais. Modelo largo

- biqueira em material compósito
- palmilha anti-perfuração em fibra compósita

**EN ISO  
20345  
2022**

EU	UK	mm	€		
37	4.5	248	160,00	1	073410637
38	5	254	160,00	1	073410638
39	6	261	160,00	1	073410639
40	6.5	268	160,00	1	073410640
41	7	274	160,00	1	073410641
42	8	281	160,00	1	073410642
43	9	288	160,00	1	073410643
44	10	294	160,00	1	073410644
45	10.5	301	160,00	1	073410645
46	11	308	160,00	1	073410646
47	12	314	160,00	1	073410647
48	13	321	160,00	1	073410648



METAL  
FREE



S1PS FO SR HRO

CE

## 7342N

sapato em microfibra RENEGADE, impermeável. Suporte à estabilidade do calcanhar. Sola em EVA com rasto em borracha nitrílica. Atacadores tradicionais. Modelo largo

- biqueira em material compósito
- palmilha anti-perfuração em fibra compósita

**EN ISO  
20345  
2022**

EU	UK	mm	€		
37	4.5	248	169,00	1	073420537
38	5	254	169,00	1	073420538
39	6	261	169,00	1	073420539
40	6.5	268	169,00	1	073420540
41	7	274	169,00	1	073420541
42	8	281	169,00	1	073420542
43	9	288	169,00	1	073420543
44	10	294	169,00	1	073420544
45	10.5	301	169,00	1	073420545
46	11	308	169,00	1	073420546
47	12	314	169,00	1	073420547
48	13	321	169,00	1	073420548



METAL  
FREE



S3S FO SR HRO

CE

## 7343N

botim em microfibra RENEGADE, impermeável. Suporte à estabilidade do calcanhar. Sola em EVA com rasto em borracha nitrílica. Atacadores tradicionais. Modelo largo

- biqueira em material compósito
- palmilha anti-perfuração em fibra compósita

**EN ISO  
20345  
2022**

EU	UK	mm	€		
37	4.5	248	185,00	1	073430537
38	5	254	185,00	1	073430538
39	6	261	185,00	1	073430539
40	6.5	268	185,00	1	073430540
41	7	274	185,00	1	073430541
42	8	281	185,00	1	073430542
43	9	288	185,00	1	073430543
44	10	294	185,00	1	073430544
45	10.5	301	185,00	1	073430545
46	11	308	185,00	1	073430546
47	12	314	185,00	1	073430547
48	13	321	185,00	1	073430548



METAL  
FREE



S3S FO SR HRO

CE





# HEAVY DUTY



## 7293HM

Bota em pele natural, lubrificada, impermeável, com sola de borracha VIBRAM®, Anti-abrasão inserido na zona do calcanhar e na biqueira. Com proteção e reforço de poliuretano.

- Biqueira em fibra de vidro
- Palmilha anti-perfuração em fibra reforçada

EN ISO 20345 2011



EU	UK	mm	€		
39	6	263	198,00	1	072930639
40	6,5	270	198,00	1	072930640
41	7	276	198,00	1	072930641
42	8	283	198,00	1	072930642
43	9	289	198,00	1	072930643
44	10	296	198,00	1	072930644
45	10,5	302	198,00	1	072930645
46	11	309	198,00	1	072930646
47	12	315	198,00	1	072930647
48	13	322	198,00	1	072930648



CE

S3 HRO HI SRC

## 7294HM

Bota em pele natural, impermeável, com sola de borracha VIBRAM®, Anti-abrasão inserido na zona do calcanhar e na biqueira. Com proteção e reforço de poliuretano.

- Biqueira em fibra de vidro
- Palmilha anti-perfuração em fibra compósita

EN ISO 20345 2011



EU	UK	mm	€		
39	6	263	210,00	1	072940639
40	6,5	270	210,00	1	072940640
41	7	276	210,00	1	072940641
42	8	283	210,00	1	072940642
43	9	289	210,00	1	072940643
44	10	296	210,00	1	072940644
45	10,5	302	210,00	1	072940645
46	11	309	210,00	1	072940646
47	12	315	210,00	1	072940647
48	13	322	210,00	1	072940648



CE

S3 HRO HI SRC

## 7294HMC

Bota em pele natural, impermeável, com sola de borracha VIBRAM®, Anti-abrasão inserido na zona do calcanhar e na biqueira. Com membrana de Tepor, impermeável, à prova de vento e respirável.

- Biqueira em fibra de vidro
- Palmilha anti-perfuração em fibra reforçada

EN ISO 20345 2011



EU	UK	mm	€		
39	6	263	234,00	1	072940739
40	6,5	270	234,00	1	072940740
41	7	276	234,00	1	072940741
42	8	283	234,00	1	072940742
43	9	289	234,00	1	072940743
44	10	296	234,00	1	072940744
45	10,5	302	234,00	1	072940745
46	11	309	234,00	1	072940746
47	12	315	234,00	1	072940747
48	13	322	234,00	1	072940748



CE

S3 HRO HI CI WR SRC



# ACCESSORIES

## 7397S

FIT4YOU inserts, suave

Inserts suaves para calçado FitEVOLUTION com o sistema patenteado FIT4YOU



EU	UK	€	📦	🚚
39/40	6/6,5	15,90	1	073970139
37/38	4,5/5	15,90	1	073970137
41/42	7/8	15,90	1	073970141
43/44	9/10	15,90	1	073970143
45/46	10,5/11	15,90	1	073970145
47/48	12/13	15,90	1	073970147

## 7397M

FIT4YOU inserts, médio

Inserts médios para calçado FitEVOLUTION com o sistema patenteado FIT4YOU



EU	UK	€	📦	🚚
37/38	4,5/5	15,90	1	073970237
39/40	6/6,5	15,90	1	073970239
41/42	7/8	15,90	1	073970241
43/44	9/10	15,90	1	073970243
45/46	10,5/11	15,90	1	073970245
47/48	12/13	15,90	1	073970247

## 7397H

FIT4YOU inserts, duro

Inserts duros para calçado FitEVOLUTION com o sistema patenteado FIT4YOU



EU	UK	€	📦	🚚
37/38	4,5/5	15,90	1	073970337
39/40	6/6,5	15,90	1	073970339
41/42	7/8	15,90	1	073970341
43/44	9/10	15,90	1	073970343
45/46	10,5/11	15,90	1	073970345
47/48	12/13	15,90	1	073970347

## 7398 0/G

palmilhas anatómicas em borracha EVA, com amortecimento no calcanhar (recomendadas para a linha de calçado 0-Gravity)



EU	UK	€	📦	🚚
38	5	8,10	1	073981238
39	6	8,10	1	073981239
40	6,5	8,10	1	073981240
41	7	8,10	1	073981241
42	8	8,10	1	073981242
43	9	8,10	1	073981243
44	10	8,10	1	073981244
45	10,5	8,10	1	073981245
46	11	8,10	1	073981246
47	12	8,10	1	073981247
48	13	8,10	1	073981248

## 7398ESD

formato anatómico, palmilha respirável, camada superior antibacteriana para prevenção de maus odores. Substituição para calçado certificado ESD (Descarga Eletroestática).



EU	UK	€	📦	🚚
35	2,5	9,30	1	073981435
36	3,5	9,30	1	073981436
37	4,5	9,30	1	073981437
38	5	9,30	1	073981438
39	6	9,30	1	073981439
40	6,5	9,30	1	073981440
41	7	9,30	1	073981441
42	8	9,30	1	073981442
43	9	9,30	1	073981443
44	10	9,30	1	073981444
45	10,5	9,30	1	073981445
46	11	9,30	1	073981446
47	12	9,30	1	073981447
48	13	9,30	1	073981448

## 7398U

palmilhas anatómicas em GEL TPR com efeito de amortecimento, suporte para arco plantar e calcanhar



EU	UK	€	📦	🚚
36 - 40	3,5 - 6,5	14,90	1	073980058
41 - 46	7 - 11	14,90	1	073980063

## 7398UP

palmilhas anatómicas em GEL TPE com fragrância cítrica e suporte para arco plantar



EU	UK	€	📦	🚚
36 - 40	3,5 - 6	13,60	1	073980076
41 - 46	7 - 11	13,60	1	073980081

## 7398GEL

palmilhas com formas anatómicas cobertas com aplicações gel



EU	UK	€	📦	🚚
35	2,5	4,90	1	073980835
36	3,5	4,90	1	073980836
37	4,5	4,90	1	073980837
38	5	4,90	1	073980838
39	6	4,90	1	073980839
40	6,5	4,90	1	073980840
41	7	4,90	1	073980841
42	8	4,90	1	073980842
43	9	4,90	1	073980843
44	10	4,90	1	073980844
45	10,5	4,90	1	073980845
46	11	4,90	1	073980846
47	12	4,90	1	073980847
48	13	4,90	1	073980848

## 7398EF

palmilhas anatómicas em espuma de poliuretano, com elevação do calcanhar



EU	UK	€	📦	📦
35	2,5	9,40	1	073981135
36	3,5	9,40	1	073981136
37	4,5	9,40	1	073981137
38	5	9,40	1	073981138
39	6	9,40	1	073981139
40	6,5	9,40	1	073981140
41	7	9,40	1	073981141
42	8	9,40	1	073981142
43	9	9,40	1	073981143
44	10	9,40	1	073981144
45	10,5	9,40	1	073981145
46	11	9,40	1	073981146
47	12	9,40	1	073981147
48	13	9,40	1	073981148

## 7399 A/N...

embalagem com 10 pares de atacadores

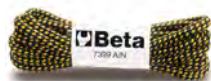

cm	€	📦	📦
100	17,70	1	073990010
120	20,90	1	073990012
140	25,50	1	073990017

Os preços indicados são para 10 unidades

## 7421

Meias de compressão, até ao joelho, reforçadas com nylon e algodão nos dedos e calcanhar. Sola de fibra de bambu resistente, antimicrobiano e respirável.



📦	EU	€	📦	📦
M	39-42	18,80	1	074210002
L	43-46	18,80	1	074210004

## 7422P

meias de cano alto em algodão reciclado, com reforço na biqueira e calcanhar

2 pares

variantes de cor:

preto com aplicações em cinza, laranja e castanho

cinza com aplicações em preto, laranja e castanho



📦	EU	€	📦	📦
M	39-42	16,40	1	074220102
L	43-46	16,40	1	074220104

## 7425

Meias respiráveis e reforçadas com nylon/algodão nos dedos e calcanhar. Sola de nylon com fibra de bambu resistente, antimicrobiano e respirável.



📦	EU	€	📦	📦
M	39-42	12,40	1	074250002
L	43-46	12,40	1	074250004

## 7426P

meias de cano médio em algodão reciclado, com sola em algodão felpudo e reforço na biqueira e calcanhar

2 pares

variantes de cor:

cinza com aplicações em preto e azul elétrico

preto com aplicações em cinza e azul elétrico



📦	EU	€	📦	📦
M	39-42	15,30	1	074260102
L	43-46	15,30	1	074260104

## 7427

Meias Sneaker com proteções e respiração na zona da tíbia e peito do pé. Reforçadas com nylon e algodão na zona dos dedos e calcanhar. Sola de fibra antimicrobiana resistente e respirável.



📦	EU	€	📦	📦
M	39-42	10,50	1	074270002
L	43-46	10,50	1	074270004

## 7430T

meias de cano baixo em algodão reciclado, com reforço na biqueira e calcanhar

3 pares

variantes de cor:

cinza melange com aplicações em preto e bordeaux

preto com aplicações em cinza

cinza melange com aplicações em preto



📦	EU	€	📦	📦
M	39-42	19,70	1	074300202
L	43-46	19,70	1	074300204

## 7431P

Dois pares de meias até ao tornozelo, com textura respirável e reforços em nylon/algodão nos dedos e calcanhar.

Solas em nylon com fibra de bambu, resistente, antifúngico e respirável.

Um par em cor em preto/laranja, outro par em cor preto/cinza.



📦	EU	€	📦	📦
M	39-42	9,30	1	074310102
L	43-46	9,30	1	074310104



# VESTUÁRIO DE TRABALHO

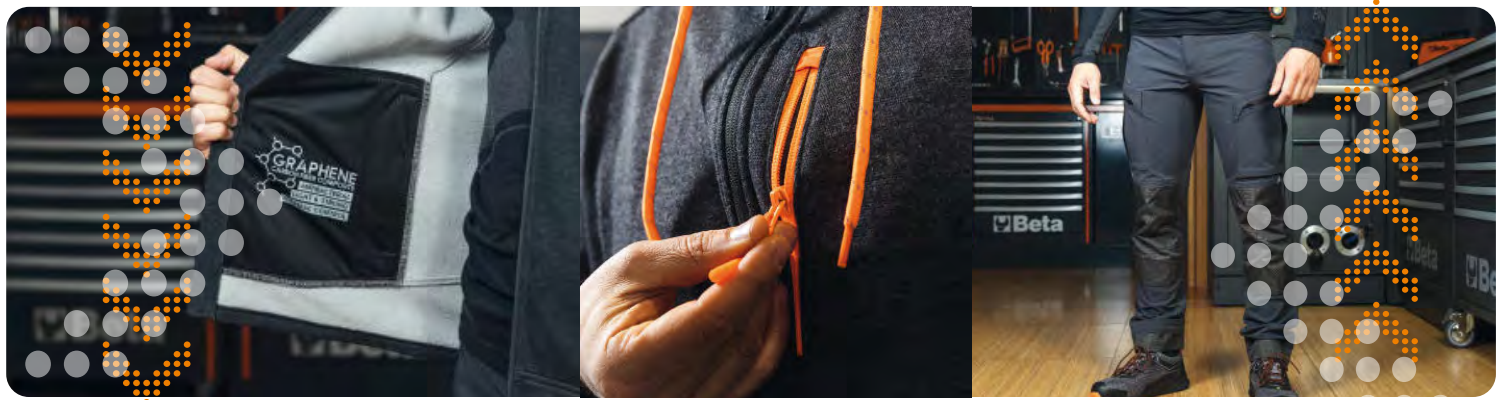

Ao longo dos anos a linha de vestuário de trabalho ganhou popularidade e a confiança dos profissionais mais exigentes.

O sucesso dos produtos traduziu-se na expansão e constante desenvolvimento desta linha.

O vestuário de trabalho fabricado pela Beta Utensili S.p.a. cumpre as seguintes normas:

### EN ISO 13688:2013

Os equipamentos de protecção pessoal protegem o utilizador de perigos físicos limitados, como pequenas escoriações, raios solares, vento, frio, poeiras e sujidade resultantes de materiais não tóxicos. Este nível de protecção está relacionado com a primeira categoria do Projecto-lei n.º 475 de 04/12/1992 do Parlamento Italiano.

### INSTRUÇÕES DE UTILIZAÇÃO E ARMAZENAMENTO

Para assegurar a protecção das diferentes partes do corpo do utilizador, os artigos devem ser correctamente utilizados. Devem igualmente ser armazenados em local fresco e seco, na embalagem original, afastados e fontes de calor e ao abrigo da luz solar, poeiras e condições atmosféricas adversas.

### ENCOLHIMENTO

Todas as fibras naturais encolhem após a lavagem. O grau de encolhimento pode variar entre 1% e 5%, dependendo de vários parâmetros, que incluem o tipo de fibras e a temperatura a água.

### PRODUTOS SAZONAIS

Para garantir que os artigos mais adequados estão disponíveis em qualquer altura do ano, a nossa coleção de vestuário de trabalho foi dividida em três estações:



**PRIMAVERA-VERÃO: Disponível de Março a Setembro,**  
é composta por artigos leves e respiráveis.



**OUTONO-INVERNO: Disponível de Setembro a Março,**  
é composta por peças quentes e resistentes, perfeitas para temperaturas extremas.

**TODAS AS ESTAÇÕES:** Linha adequada para ser usada durante todo o ano, composta por peças versáteis e práticas, sinónimo de um conforto inigualável em qualquer estação.

Cada linha alia a qualidade à comodidade e ao design, para responder às necessidades específicas de cada período do ano.

### CORRESPONDÊNCIA DE TAMANHOS

	Vestuário Masculino						Vestuário Feminino						
	I	F	D	E	UK	USA	I	F	D	E	UK	USA	
<b>XS</b>	46	38	42	40	30	32	XS	38	34	32	34	6	2
<b>S</b>	48	40	44	42	32	34	<b>S</b>	40	36	34	36	8	4
<b>M</b>	50	42	46	44	34	36	<b>M</b>	42	38	36	38	10	6
<b>L</b>	52	44	48	46	36	38	<b>L</b>	44	40	38	40	12	8
<b>XL</b>	54	46	50	48	38	40	<b>XL</b>	46	42	40	42	14	10
<b>2XL</b>	56	48	52	50	40	42	<b>2XL</b>	48	44	42	44	16	12
<b>3XL</b>	58	50	54	52	42	44	<b>3XL</b>	50	46	44	46	18	14
<b>4XL</b>	60	52	56	54	44	46							
<b>5XL</b>	62	54	58	56	46	48							

### TAMANHOS ANATÓMICOS EN ISO 13688:2013

VESTUÁRIO MASCULINO									
	XS	S	M	L	XL	2XL	3XL	4XL	5XL
<b>A</b>	88-92	92-96	96-104	104-108	108-116	116-124	124-132	132-140	140-148
<b>B</b>	79-83	83-87	87-91	91-95	95-100	100-107	107-112	112-120	120-128
<b>H</b>	158-164	164-170	170-176	176-182	182-188	188-194	194-200	200-206	206-212

VESTUÁRIO FEMININO							
	XS	S	M	L	XL	2XL	3XL
<b>B</b>	72-77	77-82	82-87	87-93	93-99	99-105	105-111
<b>H</b>	162-165	164-167	168-171	170-173	172-175	174-177	176-179

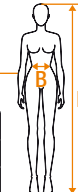

## GUIA DE VESTUÁRIO - CATÁLOGO 2025

Categoria	N.º Artigo	Linha	Pág.	Cor	Conjugações recomendadas (tecido e cor idênticos às calças)									
					Calções bermuda	Pág.	Jardineiras	Pág.	Macacões	Pág.	Coletes	Pág.	Casacos	Pág.
CALÇAS DE TRABALHO, LEVES	7610G	Trekking	653		7611G	656								
	7610N		653											
	7660B	Top Line	653		7661B	657								
	7660G		654		7661G	657								
	7820SG	Stretch	655		7821SG	657								
	7860G	Beta Easy	655		7861G	657	7863G	658	7865G	659	7867G	661	7869G	660
	7860B		655	7861B	658			7865B	658	7867B	660			
7930MG	Cotton	656		7931MG	658			7935MG	659	7937MG	661			
CALÇAS DE TRABALHO, 4 ESTAÇÕES	7600G	Trekking	652											
	7600N		652											
	7640GG	Graphene	653											
	7650	Top Line	653								7653G	659		
	7650B		653											
	7818BL		654											
	7818CM		654	7815CM	657									
	7818G		654											
	7819G		654											
	7830SN	Stretch	655		7831SN	657								
	7840BL	Beta Easy	655								7849BL	659		
7850G		655												
7900G	Beta Easy	656				7903G	658	7905G	659	7907G	661	7909G	660	
7940	Multiprotection	656										7949	660	
7818LN	Lady	654												



## GUIA DE VESTUÁRIO - CATÁLOGO 2025

Categoria	N.º Artigo	Linha	Pág.	Cor	Conjugações recomendadas (tecido e cor idênticos às calças)									
					Calções bermuda	Pág.	Jardineiras	Pág.	Macacões	Pág.	Coletes	Pág.	Casacos	Pág.
JEANS DE TRABALHO	7530		652											
	7528		652		7529	656								
	7527		652											

POLOS	7552BL		665		<b>CONJUGUE TODOS OS OUTROS ARTIGOS DE ACORDO COM COMBINAÇÕES DE CORES</b>								
	7552G		665										
	7552N		665										

T-SHIRTS	7548M		664		<b>CONJUGUE TODOS OS OUTROS ARTIGOS DE ACORDO COM COMBINAÇÕES DE CORES</b>								
	7548C		664										
	7553BL		665										
	7553G		665										
	7553N		665										
	7553V		665										
	7550G	Top Line	664										
	7550N		664										

CAMISAS	7545F		664										
---------	-------	--	-----	--	--	--	--	--	--	--	--	--	--

SWEATSHIRTS	7637G		663		<b>CONJUGUE TODOS OS OUTROS ARTIGOS DE ACORDO COM COMBINAÇÕES DE CORES</b>								
	7637B		663										
	7642G		663										
	7643G		663										
	7644GG	Graphene	663										
	7664N	Top Line	664										
	7665N		664										

CAMISOLAS POLARES	7636N		662		<b>CONJUGUE TODOS OS OUTROS ARTIGOS DE ACORDO COM COMBINAÇÕES DE CORES</b>								
	7654B	Top Line	663										
	7654N		663										
	7657B		663										
	7657N		664										

COLETES	7579QN		660		<b>CONJUGUE TODOS OS OUTROS ARTIGOS DE ACORDO COM COMBINAÇÕES DE CORES</b>								
	7647GG	Graphene	660										

CASACOS CORTA-VENTO	7648GG	Graphene	661		<b>CONJUGUE TODOS OS OUTROS ARTIGOS DE ACORDO COM COMBINAÇÕES DE CORES</b>								
	7658CM	Top Line	661										
	7659N		661										
	7669N		662										

BLUSÕES	7670G	Top Line	662		<b>CONJUGUE TODOS OS OUTROS ARTIGOS DE ACORDO COM COMBINAÇÕES DE CORES</b>								
	7679GG	Graphene	662										
	7780QN		662										
	7750N		662										

## GUIA DE VESTUÁRIO - CATÁLOGO 2025

Categoria	N.º Artigo	Linha	Pág.	Cor	Conjugações recomendadas (tecido e cor idênticos às calças)									
					Calções bermuda	Pág.	Jardineiras	Pág.	Macacões	Pág.	Coletes	Pág.	Casacos	Pág.
VESTUÁRIO IMPERMEÁVEL	7971B	Hose	665										7978B	666
	7981N	Rainproof hat	667											

ACESSÓRIOS	7980NC	Cap	668		<b>CONJUGUE TODOS OS OUTROS ARTIGOS DE ACORDO COM COMBINAÇÕES DE CORES</b>								
	7980RN	Cap	667										
	7980L	Cap with light	667										
	7982N	Cap	667										
	7984G	Belt	667										
	7985N	Belt	667										
	7996N	Technical underwear set	666										
	7997GN	Technical stretch undershirt	666										
	7998GN	Technical stretch underpants	666										



# PANTS



**7527**  
jeans de trabalho,  
70% algodão, 27% poliéster e 3% elastano  
Regular fit

CE

Jeans



XS	IT	€	1	075270046
S	48	57,00	1	075270048
M	50	57,00	1	075270050
L	52	57,00	1	075270052
XL	54	57,00	1	075270054
2XL	56	57,00	1	075270056
3XL	58	57,00	1	075270058

**7528**

Jeans de trabalho elásticos, 98% cotton, 2% elastano, modelo slim

CE

Jeans



XS	IT	€	1	075280046
S	48	63,00	1	075280048
M	50	63,00	1	075280050
L	52	63,00	1	075280052
XL	54	63,00	1	075280054
2XL	56	63,00	1	075280056
3XL	58	63,00	1	075280058

**7530**

calças de trabalho elásticas, 98% algodão e 2% tecido elástico, com reforços em poliéster. Modelo slim.

CE

Jeans



XS	IT	€	1	075300046
S	48	73,50	1	075300048
M	50	73,50	1	075300050
L	52	73,50	1	075300052
XL	54	73,50	1	075300054
2XL	56	73,50	1	075300056
3XL	58	73,50	1	075300058

**76006**

calças "work trekking", PESADAS, 90% nylon, 10% tecido elástico, 265 g/m<sup>2</sup>, tecido reforçado nos joelhos e na parte de trás, bainhas elásticas com fecho vertical  
Cinza escuro, com detalhes em verde fluorescente  
Slim fit

CE

TREKKING HEAVY



XS	IT	€	1	076000000
S	48	77,00	1	076000001
M	50	77,00	1	076000002
L	52	77,00	1	076000003
XL	54	77,00	1	076000004
2XL	56	77,00	1	076000005
3XL	58	77,00	1	076000006

**7600N**

calças "work trekking", PESADAS, 90% nylon, 10% tecido elástico, 265 g/m<sup>2</sup>, joelhos e parte traseira reforçados, bainhas elásticas com fecho vertical  
Cinza escuro, com detalhes em verde fluorescente  
Slim fit

CE

TREKKING HEAVY



XS	IT	€	1	076000100
S	48	77,00	1	076000101
M	50	77,00	1	076000102
L	52	77,00	1	076000103
XL	54	77,00	1	076000104
2XL	56	77,00	1	076000105
3XL	58	77,00	1	076000106

## 7610G

calças "work trekking" LIGHT, 90% nylon, tecido 10% tecido elástico, 140 g/m<sup>2</sup>, reforço nos joelhos e parte traseira, cordão e bainhas em tecido stretch.  
Cinza escuro com detalhes em amarelo.  
Slim fit

CE

TREKKING  
LIGHT

IT	€	👤	📄
XS 46	74,50	1	076100000
S 48	74,50	1	076100001
M 50	74,50	1	076100002
L 52	74,50	1	076100003
XL 54	74,50	1	076100004
2XL 56	74,50	1	076100005
3XL 58	74,50	1	076100006

## 7640GG

calças de trabalho elásticas, estilo multibolsos, 90% nylon com grafeno, 10% elastano, poliéster 250 g/m<sup>2</sup>, reforçado com Oxford 600D, cinza Reguladoras de temperatura, impermeáveis e de secagem rápida  
Slim fit

CE

GRAPHENE  
CARBON FIBER COMPOSITE  
ANTIBACTERIAL  
TIGHT & STRONG  
THERMAL CONTROL



IT	€	👤	📄
XS 46	97,00	1	076400010
S 48	97,00	1	076400011
M 50	97,00	1	076400012
L 52	97,00	1	076400013
XL 54	97,00	1	076400014
2XL 56	97,00	1	076400015
3XL 58	97,00	1	076400016

## 7650B

calças de trabalho elásticas, estilo multibolsos, 90% nylon - 10% elastano, 260 g/m<sup>2</sup>, azul Bolsos nos joelhos, bolsos traseiros e bainhas reforçados em poliéster 600D, entrepernas reforçado

SUJEITO À DISPONIBILIDADE

CE

TOP  
line

IT	€	👤	📄
XS 46	97,00	1	076500100
S 48	97,00	1	076500101
M 50	97,00	1	076500102
L 52	97,00	1	076500103
XL 54	97,00	1	076500104
2XL 56	97,00	1	076500105
3XL 58	97,00	1	076500106

## 7610N

calças "work trekking" LIGHT, 90% nylon, tecido 10% tecido elástico, 140 g/m<sup>2</sup>, reforço nos joelhos e parte traseira, cordão e bainhas em tecido stretch.  
Preto com detalhes em amarelo.  
Slim fit

CE

TREKKING  
LIGHT

IT	€	👤	📄
XS 46	74,50	1	076100100
S 48	74,50	1	076100101
M 50	74,50	1	076100102
L 52	74,50	1	076100103
XL 54	74,50	1	076100104
2XL 56	74,50	1	076100105
3XL 58	74,50	1	076100106

## 7650

calças de trabalho elásticas, estilo multibolsos 90% nylon - 10% elastano, 260 g/m<sup>2</sup>, cinzento antracite Reforços em poliéster 600D nos joelhos, bolsos traseiros e bainhas. Entrepernas reforçado.

SUJEITO À DISPONIBILIDADE

CE

TOP  
line

IT	€	👤	📄
XS 46	97,00	1	076500000
S 48	97,00	1	076500001
M 50	97,00	1	076500002
L 52	97,00	1	076500003
XL 54	97,00	1	076500004
2XL 56	97,00	1	076500005
3XL 58	97,00	1	076500006

## 7660B

calças de trabalho elásticas, leves, estilo multibolsos, 86% nylon - 14% elastano, 140 g/m<sup>2</sup>, azul bolsos nos joelhos, bolsos traseiros reforçados em poliéster 300D, entrepernas reforçado  
Slim fit

SUJEITO À DISPONIBILIDADE

CE

TOP  
line

IT	€	👤	📄
XS 46	83,50	1	076600100
S 48	83,50	1	076600101
M 50	83,50	1	076600102
L 52	83,50	1	076600103
XL 54	83,50	1	076600104
2XL 56	83,50	1	076600105
3XL 58	83,50	1	076600106



## 7660G

calças de trabalho elásticas, leves, estilo multibolsos, 86% nylon - 14% elastano, 140 g/m<sup>2</sup>, cinza antracite  
bolsos nos joelhos, bolsos traseiros reforçados em poliéster 300D, entrepernas reforçado  
Slim fit

**SUJEITO À DISPONIBILIDADE**

CE



TOP  
line



MAXI/MINI	IT	€	👤	📄
XS	46	83,50	1	076600000
S	48	83,50	1	076600001
M	50	83,50	1	076600002
L	52	83,50	1	076600003
XL	54	83,50	1	076600004
2XL	56	83,50	1	076600005
3XL	58	83,50	1	076600006

## 7818BL

calças de trabalho, estilo multi-bolsos, em lona T/C, 260 g/m<sup>2</sup>, azuis  
Com inserção de tecido elástico entrepernas  
Bolsos acolchoados nos joelhos e bainhas reforçadas em poliéster 300D, entrepernas à prova de desgaste e com inserção de tecido elástico; região lombar com elástico para facilidade de movimentos

CE



MAXI/MINI	IT	€	👤	📄
XS	46	74,50	1	078180100
S	48	74,50	1	078180101
M	50	74,50	1	078180102
L	52	74,50	1	078180103
XL	54	74,50	1	078180104
2XL	56	74,50	1	078180105
3XL	58	74,50	1	078180106

## 7818LN

calças de trabalho para mulher, estilo multi-bolsos, pretas com detalhes rosa, 100% algodão elástico, 220 g/m<sup>2</sup>  
Bolsos acolchoados nos joelhos e bainhas reforçadas em poliéster 300D, entrepernas à prova de desgaste e com inserção de tecido elástico; região lombar com elástico para facilidade de movimentos

CE

lady



MAXI/MINI	IT	€	👤	📄
XS	38	74,50	1	078180200
S	40	74,50	1	078180201
M	42	74,50	1	078180202
L	44	74,50	1	078180203
XL	46	74,50	1	078180204
2XL	48	74,50	1	078180205
3XL	50	74,50	1	078180206

## 7818G

calças de trabalho, estilo multi-bolsos, em lona T/C, 260 g/m<sup>2</sup>, cinza  
Bolsos acolchoados nos joelhos e bainhas reforçadas em poliéster 300D, entrepernas à prova de desgaste e com inserção de tecido elástico; região lombar com elástico para facilidade de movimentos

CE



MAXI/MINI	IT	€	👤	📄
XS	46	74,50	1	078180000
S	48	74,50	1	078180001
M	50	74,50	1	078180002
L	52	74,50	1	078180003
XL	54	74,50	1	078180004
2XL	56	74,50	1	078180005
3XL	58	74,50	1	078180006

## 7818CM

calças de trabalho, estilo multi-bolsos, tecido em lona de algodão, 260 g/m<sup>2</sup>, camuflado cinzento  
Bolsos tipo joelheiras e bainhas reforçadas em poliéster 300D, entrepernas à prova de rasgões e inserções de tecido elástico no interior da perna e na região lombar para movimentos mais fáceis

**SUJEITO À DISPONIBILIDADE**

CE



MAXI/MINI	IT	€	👤	📄
XS	46	79,00	1	078180300
S	48	79,00	1	078180301
M	50	79,00	1	078180302
L	52	79,00	1	078180303
XL	54	79,00	1	078180304
2XL	56	79,00	1	078180305
3XL	58	79,00	1	078180306

## 7819G

calças de trabalho, estilo multibolsos, com bolsos amovíveis, lona T/C, 260 g/m<sup>2</sup>, cinza  
160 / 5 000 Resultados da tradução  
Resultado de tradução, Bolsos acolchoados nos joelhos e bainhas reforçadas em poliéster 300D, entrepernas antidesgaste e aplicações em tecido elástico na parte interna das pernas e na região lombar para facilitar os movimentos

CE



MAXI/MINI	IT	€	👤	📄
XS	46	74,50	1	078190000
S	48	74,50	1	078190001
M	50	74,50	1	078190002
L	52	74,50	1	078190003
XL	54	74,50	1	078190004
2XL	56	74,50	1	078190005
3XL	58	74,50	1	078190006

### 7830SN

calças de trabalho elásticas, em sarja T/C, 200 g/m<sup>2</sup>, pretas  
Modelo ajustado, entrepernas à prova de desgaste e cintura elástica nas laterais

SUJEITO À DISPONIBILIDADE

CE

STRETCH



IT	€		
XS 46	66,50	1	078300100
S 48	66,50	1	078300101
M 50	66,50	1	078300102
L 52	66,50	1	078300103
XL 54	66,50	1	078300104
2XL 56	66,50	1	078300105
3XL 58	66,50	1	078300106

### 7840BL

calças de trabalho em lona T/C, 245 g/m<sup>2</sup>, azul  
Cintura elástica dos lados

CE

Beta EASY



IT	€		
XS 46	42,50	1	078400100
S 48	42,50	1	078400101
M 50	42,50	1	078400102
L 52	42,50	1	078400103
XL 54	42,50	1	078400104
2XL 56	42,50	1	078400105
3XL 58	42,50	1	078400106
4XL 60	42,50	1	078400107

### 7860B

calças de trabalho, leves, em sarja T/C, 180 g/m<sup>2</sup>, aplicações em poliéster "Oxford", azuis

CE

Beta EASY

LIGHT



IT	€		
XS 46	55,00	1	078600700
S 48	55,00	1	078600701
M 50	55,00	1	078600702
L 52	55,00	1	078600703
XL 54	55,00	1	078600704
2XL 56	55,00	1	078600705
3XL 58	55,00	1	078600706
4XL 60	55,00	1	078600707
5XL 62	55,00	1	078600708

### 7820SG

calças de trabalho elásticas, estilo multibolsos, 39% algodão, 61% poliéster, em tecido ripstop elástico, 170 g/m<sup>2</sup>, cinza  
Bolsos para joelheiras e cintura elástica de lado. Ajuste regular

CE

STRETCH



IT	€		
XS 46	64,50	1	078200100
S 48	64,50	1	078200101
M 50	64,50	1	078200102
L 52	64,50	1	078200103
XL 54	64,50	1	078200104
2XL 56	64,50	1	078200105
3XL 58	64,50	1	078200106

### 7850G

calças de trabalho cargo, 100% algodão, 240 g/m<sup>2</sup>, cós elástico nas laterais e bolsos laterais grandes com aplicações refletoras, cinza com detalhes em verde fluorescente  
Slim fit

CE



IT	€		
XS 46	48,00	1	078500100
S 48	48,00	1	078500101
M 50	48,00	1	078500102
L 52	48,00	1	078500103
XL 54	48,00	1	078500104
2XL 56	48,00	1	078500105
3XL 58	48,00	1	078500106
4XL 60	48,00	1	078500107

### 7860G

calças de trabalho, linha light, em sarja T/C 180 g/m<sup>2</sup>, aplicações "Oxford", cinza.  
Novo design, corte aperfeiçoado.

CE

Beta EASY

LIGHT



IT	€		
XS 46	55,00	1	078600800
S 48	55,00	1	078600801
M 50	55,00	1	078600802
L 52	55,00	1	078600803
XL 54	55,00	1	078600804
2XL 56	55,00	1	078600805
3XL 58	55,00	1	078600806
4XL 60	55,00	1	078600807
5XL 62	55,00	1	078600808

## 79006

calças de trabalho em lona T/C, 260 g/m<sup>2</sup>, aplicações "Oxford", cinzento.  
Novo design, corte aperfeiçoado.

CE

Beta EASY



IT	€	1	079000800
XS 46	61,00	1	079000800
S 48	61,00	1	079000801
M 50	61,00	1	079000802
L 52	61,00	1	079000803
XL 54	61,00	1	079000804
2XL 56	61,00	1	079000805
3XL 58	61,00	1	079000806
4XL 60	61,00	1	079000807

## 7940

calças de trabalho multi-proteção sarja T/C, 250 g/m<sup>2</sup>, azul, para proteção contra calor, chamas, efeitos de arco elétrico, perigos decorrentes de soldadura e produtos químicos.

CE



7949



66U

DPI: III<sup>A</sup> Categoria  
EN ISO 11611:2015 - Classe 1  
EN ISO 11612:2015 - A1 B1  
C1  
EN ISO 1149-5:2018  
EN13034:2005+A1:2009  
- Type 6  
IEC 61482-2:2018 - APC 1

IT	€	1	079400000
XS 46	88,50	1	079400000
S 48	88,50	1	079400001
M 50	88,50	1	079400002
L 52	88,50	1	079400003
XL 54	88,50	1	079400004
2XL 56	88,50	1	079400005

## 7930MG

calças de trabalho, estilo multibolsos, 97% algodão, 3% elastano, 220 g/m<sup>2</sup>, cinza

CE

Cotton



IT	€	1	079300400
XS 46	62,00	1	079300400
S 48	62,00	1	079300401
M 50	62,00	1	079300402
L 52	62,00	1	079300403
XL 54	62,00	1	079300404
2XL 56	62,00	1	079300405
3XL 58	62,00	1	079300406

# BERMUDA



## 7529

Calções de trabalho em ganga elástica, 98% algodão, 2% elastano, modelo slim

CE

Jeans



IT	€	1	075290046
XS 46	49,50	1	075290046
S 48	49,50	1	075290048
M 50	49,50	1	075290050
L 52	49,50	1	075290052
XL 54	49,50	1	075290054
2XL 56	49,50	1	075290056
3XL 58	49,50	1	075290058

## 7611G

calções tipo bermudas "work trekking" LIGHT, 90% nylon, 10% tecido elástico, 140 g/m<sup>2</sup>, tecido reforçado na parte traseira. Cinza escuro com detalhes em amarelo. Slim fit

CE

TREKKING LIGHT



IT	€	1	076110000
XS 46	57,00	1	076110000
S 48	57,00	1	076110001
M 50	57,00	1	076110002
L 52	57,00	1	076110003
XL 54	57,00	1	076110004
2XL 56	57,00	1	076110005
3XL 58	57,00	1	076110006



# Beta





## 7661B

bermudas de trabalho elásticas, leves, estilo multibolsos, 86% nylon - 14% elastano, 140 g/m<sup>2</sup>, azul  
bolsos traseiros reforçados em poliéster 300D, entrepernas reforçado Slim fit

SUJEITO À DISPONIBILIDADE

CE



IT	€		
XS 46	72,50	1	076610100
S 48	72,50	1	076610101
M 50	72,50	1	076610102
L 52	72,50	1	076610103
XL 54	72,50	1	076610104
2XL 56	72,50	1	076610105
3XL 58	72,50	1	076610106



## 7815CM

calções de trabalho tipo bermudas, estilo multibolsos, tecido em lona de algodão, 260 g/m<sup>2</sup>, camuflado cinzento, entrepernas à prova de rasgões e inserções de tecido elástico no interior da perna e na região lombar para movimentos mais fáceis

SUJEITO À DISPONIBILIDADE

CE



IT	€		
XS 46	62,00	1	078150300
S 48	62,00	1	078150301
M 50	62,00	1	078150302
L 52	62,00	1	078150303
XL 54	62,00	1	078150304
2XL 56	62,00	1	078150305
3XL 58	62,00	1	078150306

## 7821SG

bermudas de trabalho elásticas, estilo multibolsos, 39% algodão, 61% poliéster, em tecido ripstop elástico, 170 g/m<sup>2</sup> e cintura elástica de lado. Ajuste regular

CE



IT	€		
XS 46	50,50	1	078210100
S 48	50,50	1	078210101
M 50	50,50	1	078210102
L 52	50,50	1	078210103
XL 54	50,50	1	078210104
2XL 56	50,50	1	078210105
3XL 58	50,50	1	078210106



## 7661G

bermudas de trabalho elásticas, leves, estilo multibolsos, 86% nylon - 14% elastano, 140 g/m<sup>2</sup>, cinza antracite  
bolsos traseiros reforçados em poliéster 300D, entrepernas reforçado Slim fit

SUJEITO À DISPONIBILIDADE

CE



IT	€		
XS 46	72,50	1	076610000
S 48	72,50	1	076610001
M 50	72,50	1	076610002
L 52	72,50	1	076610003
XL 54	72,50	1	076610004
2XL 56	72,50	1	076610005
3XL 58	72,50	1	076610006

## 7831SN

calções Bermuda elásticos, em sarja T/C, 200 g/m<sup>2</sup>, pretos  
Modelo ajustado, entrepernas à prova de desgaste e cintura elástica nas laterais

SUJEITO À DISPONIBILIDADE

CE



IT	€		
XS 46	50,50	1	078310100
S 48	50,50	1	078310101
M 50	50,50	1	078310102
L 52	50,50	1	078310103
XL 54	50,50	1	078310104
2XL 56	50,50	1	078310105
3XL 58	50,50	1	078310106

## 7861G

calções de trabalho, linha light, em sarja T/C, 180 g/m<sup>2</sup>, com aplicações "Oxford", cinza.  
Novo design, corte aperfeiçoado.

CE



IT	€		
XS 46	45,50	1	078610800
S 48	45,50	1	078610801
M 50	45,50	1	078610802
L 52	45,50	1	078610803
XL 54	45,50	1	078610804
2XL 56	45,50	1	078610805
3XL 58	45,50	1	078610806
4XL 60	45,50	1	078610807
5XL 62	45,50	1	078610808



## 7861B

calções bermudas de trabalho, leves, em sarja T/C, 180 g/m<sup>2</sup>, aplicações em poliéster "Oxford", azuis

CE **BetaEASY**

LIGHT



GRANDEZZA	IT	€	U	U
XS	46	45,50	1	078610700
S	48	45,50	1	078610701
M	50	45,50	1	078610702
L	52	45,50	1	078610703
XL	54	45,50	1	078610704
2XL	56	45,50	1	078610705
3XL	58	45,50	1	078610706
4XL	60	45,50	1	078610707
5XL	62	45,50	1	078610708

## 7931MG

calções bermudas de trabalho, 97% algodão, 3% elastano, 220 g/m<sup>2</sup>, cinza

CE

Cotton



GRANDEZZA	IT	€	U	U
XS	46	49,50	1	079310400
S	48	49,50	1	079310401
M	50	49,50	1	079310402
L	52	49,50	1	079310403
XL	54	49,50	1	079310404
2XL	56	49,50	1	079310405
3XL	58	49,50	1	079310406

# OVERALLS



## 7863G

jardineiras de trabalho, leves, em sarja T/C, 180 g/m<sup>2</sup>, aplicações em poliéster Oxford, cinza.  
Novo design, corte aperfeiçoado.

CE **BetaEASY**

LIGHT



GRANDEZZA	IT	€	U	U
XS	46	67,50	1	078630800
S	48	67,50	1	078630801
M	50	67,50	1	078630802
L	52	67,50	1	078630803
XL	54	67,50	1	078630804
2XL	56	67,50	1	078630805
3XL	58	67,50	1	078630806
4XL	60	67,50	1	078630807
5XL	62	67,50	1	078630808

## 7903G

jardineiras de trabalho, em lona T/C, 260 g/m<sup>2</sup>, com aplicações "Oxford", cinzento.  
Novo design, corte aperfeiçoado

CE

**BetaEASY**



GRANDEZZA	IT	€	U	U
XS	46	76,50	1	079030800
S	48	76,50	1	079030801
M	50	76,50	1	079030802
L	52	76,50	1	079030803
XL	54	76,50	1	079030804
2XL	56	76,50	1	079030805
3XL	58	76,50	1	079030806
4XL	60	76,50	1	079030807

## 7865B

macacão de trabalho, leve, em sarja T/C, 180 g/m<sup>2</sup>, aplicações em poliéster "Oxford", azul

CE

**BetaEASY**

LIGHT



GRANDEZZA	IT	€	U	U
XS	46	87,50	1	078650700
S	48	87,50	1	078650701
M	50	87,50	1	078650702
L	52	87,50	1	078650703
XL	54	87,50	1	078650704
2XL	56	87,50	1	078650705
3XL	58	87,50	1	078650706
4XL	60	87,50	1	078650707
5XL	62	87,50	1	078650708





## 7865G

macacão de trabalho, leve, sarja T/C, 180 g/m<sup>2</sup>, aplicações em poliéster "Oxford", cinza. Novo design, corte aperfeiçoado.

CE

Beta EASY

LIGHT



IT	€	IT	€
XS 46	87,50	1 078650800	
S 48	87,50	1 078650801	
M 50	87,50	1 078650802	
L 52	87,50	1 078650803	
XL 54	87,50	1 078650804	
2XL 56	87,50	1 078650805	
3XL 58	87,50	1 078650806	
4XL 60	87,50	1 078650807	
5XL 62	87,50	1 078650808	



# Beta

## 7905G

macacão de trabalho, lona T/C, 260 g/m<sup>2</sup>, aplicações em poliéster "Oxford", cinza. Novo design, corte aperfeiçoado.

CE

Beta EASY



IT	€	IT	€
XS 46	95,00	1 079050800	
S 48	95,00	1 079050801	
M 50	95,00	1 079050802	
L 52	95,00	1 079050803	
XL 54	95,00	1 079050804	
2XL 56	95,00	1 079050805	
3XL 58	95,00	1 079050806	
4XL 60	95,00	1 079050807	

## 7935MG

macacão de trabalho, 97% algodão, 3% elastano, 220 g/m<sup>2</sup>, cinza

CE

Cotton



IT	€	IT	€
XS 46	109,00	1 079350400	
S 48	109,00	1 079350401	
M 50	109,00	1 079350402	
L 52	109,00	1 079350403	
XL 54	109,00	1 079350404	
2XL 56	109,00	1 079350405	
3XL 58	109,00	1 079350406	



# WORK JACKETS



## 7653G

casaco de trabalho elástico, multibolsos, 90% nylon, 10% elastano, 260 g/m<sup>2</sup>, cinza antracite.

SUJEITO À DISPONIBILIDADE

CE



TOP line



IT	€	IT	€
XS	97,50	1 076530000	
S	97,50	1 076530001	
M	97,50	1 076530002	
L	97,50	1 076530003	
XL	97,50	1 076530004	
2XL	97,50	1 076530005	
3XL	97,50	1 076530006	

## 7849BL

casaco de trabalho em lona T/C, 245 g/m<sup>2</sup>, azul  
Elástico na cintura

CE

Beta EASY



IT	€	IT	€
XS	45,50	1 078490100	
S	45,50	1 078490101	
M	45,50	1 078490102	
L	45,50	1 078490103	
XL	45,50	1 078490104	
XXL	45,50	1 078490105	
XXXL	45,50	1 078490106	
XXXXL	45,50	1 078490107	



## 78696

casaco de trabalho, leve, em sarja T/C, 180 g/m<sup>2</sup>, aplicações "Oxford", cinzento.  
Novo design, corte aperfeiçoado.

CE **Beta EASY**

LIGHT



XS	€	1	078690800
S	59,50	1	078690801
M	59,50	1	078690802
L	59,50	1	078690803
XL	59,50	1	078690804
XXL	59,50	1	078690805
XXXL	59,50	1	078690806
XXXXL	59,50	1	078690807
5XL	59,50	1	078690808

## 79096

casaco de trabalho, em lona T/C, 260 g/m<sup>2</sup>, aplicações "Oxford", cinzento.  
Novo design, corte aperfeiçoado.

CE **Beta EASY**



XS	€	1	079090800
S	67,50	1	079090801
M	67,50	1	079090802
L	67,50	1	079090803
XL	67,50	1	079090804
XXL	67,50	1	079090805
XXXL	67,50	1	079090806
XXXXL	67,50	1	079090807

## 7949

casaco de trabalho multi-proteção, sarja T/C, 250 g/m<sup>2</sup>, azul, para proteção contra calor, chamas, efeitos de arco elétrico, perigos decorrentes de soldadura e produtos químicos.

CE

DPI: IIIª Categoria  
EN ISO 11611:2015 - Classe 1  
EN ISO 11612:2015 - A1 B1 C1  
EN 1149-5:2018  
EN13034:2005+A1:2009 - Type 6  
IEC 61482-2:2018 - APC 1



XS	€	1	079490000
S	102,00	1	079490001
M	102,00	1	079490002
L	102,00	1	079490003
XL	102,00	1	079490004
XXL	102,00	1	079490005
XXXL	102,00	1	079490006
XXXXL	102,00	1	079490007

## 764766

colete de trabalho, tecido exterior: 96% poliéster, 4% elastano, 280 g/m<sup>2</sup>; tecido interior: 100% poliéster com grafeno, cinza/preto  
Regulador de temperatura, impermeável e respirável

CE

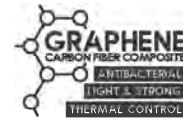

XS	€	1	076470010
S	78,00	1	076470011
M	78,00	1	076470012
L	78,00	1	076470013
XL	78,00	1	076470014
XXL	78,00	1	076470015
XXXL	78,00	1	076470016

## 7867B

colete de trabalho, leve, em sarja T/C, 180 g/m<sup>2</sup>, aplicações em poliéster "Oxford", azul

CE

**Beta EASY**

LIGHT



XS	€	1	078670700
S	51,00	1	078670701
M	51,00	1	078670702
L	51,00	1	078670703
XL	51,00	1	078670704
XXL	51,00	1	078670705
XXXL	51,00	1	078670706
XXXXL	51,00	1	078670707
5XL	51,00	1	078670708

## SLEEVELESS JACKETS



## 7579QN

Colete de trabalho, estilo multi-bolsos, composto por dois materiais 100% nylon 300D impermeável e tecido softshell, 96% poliéster, 4% elastano, acolchoado em poliéster, 160 g/m<sup>2</sup>. Preto/ cinza antracite

CE



S	€	1	075790201
M	77,50	1	075790202
L	77,50	1	075790203
XL	77,50	1	075790204
XXL	77,50	1	075790205
XXXL	77,50	1	075790206



**7867G**

colete de trabalho, leve, em sarja TC, 180 g/m<sup>2</sup>, aplicações em poliéster "Oxford", cinza.  
Novo design, corte aperfeiçoado.

CE

**BetaEASY**

LIGHT



	€		
XS	51,00	1	078670800
S	51,00	1	078670801
M	51,00	1	078670802
L	51,00	1	078670803
XL	51,00	1	078670804
XXL	51,00	1	078670805
XXXL	51,00	1	078670806
XXXXL	51,00	1	078670807
5XL	51,00	1	078670808

**7907G**

colete de trabalho, em lona T/C, 260 g/m<sup>2</sup>, aplicações em "Oxford", cinza.  
Novo design, corte aperfeiçoado.

CE

**BetaEASY**

	€		
XS	56,50	1	079070800
S	56,50	1	079070801
M	56,50	1	079070802
L	56,50	1	079070803
XL	56,50	1	079070804
XXL	56,50	1	079070805
XXXL	56,50	1	079070806
XXXXL	56,50	1	079070807

**7937MG**

colete de trabalho, 97% algodão, 3% elastano, 220 g/m<sup>2</sup>, cinza

CE

Cotton



	€		
XS	57,50	1	079370400
S	57,50	1	079370401
M	57,50	1	079370402
L	57,50	1	079370403
XL	57,50	1	079370404
XXL	57,50	1	079370405
XXXL	57,50	1	079370406

**JACKETS****7648GG**

casaco de trabalho, 96% poliéster, 4% elastano, 310 g/m<sup>2</sup>

Tecido interior: lã - 100% poliéster com grafeno

Com capuz amovível

Regulador de temperatura, com membrana

TPU impermeável, corta-vento e respirável

(resistência a colunas de água até 8.000 mm - respirabilidade 5.000 mvp)

Cinza/preto

CE

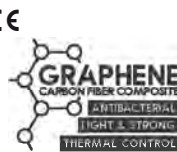

	€		
XS	126,00	1	076480010
S	126,00	1	076480011
M	126,00	1	076480012
L	126,00	1	076480013
XL	126,00	1	076480014
XXL	126,00	1	076480015
XXXL	126,00	1	076480016

**Beta****7658CM**

casaco softshell, 94% poliéster, 6% elastano, 290 g/m<sup>2</sup>, cinza camuflagem

Com membrana impermeável, corta-vento, TPU

respirável

(resistência a colunas de água até 8.000 mm -

respirabilidade 8.000 mvp)

SUJEITO À DISPONIBILIDADE

TOP line



	€		
S	123,00	1	076580101
M	123,00	1	076580102
L	123,00	1	076580103
XL	123,00	1	076580104
XXL	123,00	1	076580105
XXXL	123,00	1	076580106

**7659N**

casaco softshell, 94% poliéster, 6% elastano, 290 g/m<sup>2</sup>, com capuz e mangas amovíveis, preto

Com membrana TPU, impermeável, à prova de vento e respirável (resistente a colunas de água até 8.000 mm - respirabilidade 8.000 mvp)

SUJEITO À DISPONIBILIDADE

TOP line



	€		
S	158,00	1	076590001
M	158,00	1	076590002
L	158,00	1	076590003
XL	158,00	1	076590004
XXL	158,00	1	076590005
XXXL	158,00	1	076590006



## 7669N

casaco de trabalho elástico, leve, estilo multibolsos, 86% nylon, 14% elastano, 140 g/m<sup>2</sup>, preto  
com mangas amovíveis e capuz desdobrável, impermeável, corta-vento

SUJEITO À DISPONIBILIDADE



GRANDI	€	👤	📄
XS	110,00	1	076690000
S	110,00	1	076690001
M	110,00	1	076690002
L	110,00	1	076690003
XL	110,00	1	076690004
XXL	110,00	1	076690005
XXXL	110,00	1	076690006

## 7670G

casaco Anorak em poliéster Oxford 300D, impermeável, revestimento PU, cinza antracite  
Com capuz amovível e mangas reforçadas. Impermeável, corta-vento e respirável (resistência a colunas de água até 2,000 mm - respirabilidade 2,000 mvp)  
forro poliéster 210T, acolchoado poliéster, corpo 120 g/m<sup>2</sup>, mangas 100 g/m<sup>2</sup>s

SUJEITO À DISPONIBILIDADE



GRANDI	€	👤	📄
S	110,00	1	076700001
M	110,00	1	076700002
L	110,00	1	076700003
XL	110,00	1	076700004
XXL	110,00	1	076700005
XXXL	110,00	1	076700006



## 76796G

casaco de trabalho com acolchoado em grafeno, 80 g/m<sup>2</sup>.

Frente e costas: 100% poliéster 75D

Laterais e mangas: 96% poliéster, 4%

elastano

Regulador de temperatura, impermeável, corta-vento e respirável (resistência a colunas de água até 8.000 mm - respirabilidade 5.000 mvp)

Cinza/preto

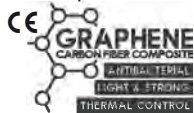

GRANDI	€	👤	📄
XS	103,00	1	076790010
S	103,00	1	076790011
M	103,00	1	076790012
L	103,00	1	076790013
XL	103,00	1	076790014
XXL	103,00	1	076790015
XXXL	103,00	1	076790016

## 7780QN

• Blusão de trabalho, estilo multi-bolsos, confeccionado com duplo material. • 100% nylon impermeável 300D e tecido softshell, 96% poliéster, 4% elastano, acolchoado em poliéster, 160 g/m<sup>2</sup> com capuz fixo • preto/cinza antracite

SUJEITO À DISPONIBILIDADE



GRANDI	€	👤	📄
S	131,00	1	077800201
M	131,00	1	077800202
L	131,00	1	077800203
XL	131,00	1	077800204
XXL	131,00	1	077800205
XXXL	131,00	1	077800206

## 7750N

casaco de trabalho, estilo multibolsos, 100% poliéster, acolchoamento 100% poliéster, 120 g/m<sup>2</sup>,

preto

CE



GRANDI	€	👤	📄
XS	82,50	1	077500000
S	82,50	1	077500001
M	82,50	1	077500002
L	82,50	1	077500003
XL	82,50	1	077500004
XXL	82,50	1	077500005
XXXL	82,50	1	077500006
XXXXL	82,50	1	077500007

## SWEATSHIRT & FLEECE



## 7636N

camisola em microfibra, com fecho curto, 180 g/m<sup>2</sup>

preta com detalhes refletivos



GRANDI	€	👤	📄
XS	27,00	1	076360500
S	27,00	1	076360501
M	27,00	1	076360502
L	27,00	1	076360503
XL	27,00	1	076360504
XXL	27,00	1	076360505
XXXL	27,00	1	076360506



## 7637B

casaco com capuz, com fecho de correr comprido, 250 g/m<sup>2</sup>  
100% lã de poliéster, com inserts em tecido softshell 100D com lã, 270 g/m<sup>2</sup>  
azul/preto



	€		
XS	87,00	1	076370100
S	87,00	1	076370101
M	87,00	1	076370102
L	87,00	1	076370103
XL	87,00	1	076370104
XXL	87,00	1	076370105
XXXL	87,00	1	076370106

## 7637G

Sweatshirt técnica, fecho de correr longo, 250 g/m<sup>2</sup>, com capuz, em lã, 100% poliéster, inserções em tecido softshell 100D, com tecido polar, 270 g/m<sup>2</sup> mesclado cinza/preto



	€		
XS	87,00	1	076370000
S	87,00	1	076370001
M	87,00	1	076370002
L	87,00	1	076370003
XL	87,00	1	076370004
XXL	87,00	1	076370005
XXXL	87,00	1	076370006

## 7642G

sweatshirt de gola redonda, 240 g/m<sup>2</sup>, 60% algodão, 40% poliéster, cinza melange, aplicações pretas



	€		
XS	33,00	1	076420000
S	33,00	1	076420001
M	33,00	1	076420002
L	33,00	1	076420003
XL	33,00	1	076420004
XXL	33,00	1	076420005
XXXL	33,00	1	076420006

## 7643G

sweatshirt, com fecho de correr curto, 80% algodão, 20% poliéster, 280 g/m<sup>2</sup>, cinza antracite/claro



	€		
XS	50,50	1	076430000
S	50,50	1	076430001
M	50,50	1	076430002
L	50,50	1	076430003
XL	50,50	1	076430004
XXL	50,50	1	076430005
XXXL	50,50	1	076430006

## 7644GG

casaco stretch, com fecho de correr comprido, 280 g/m<sup>2</sup>, 60% algodão, 40% poliéster com grafeno  
Regulador de temperatura, respirável e de fácil manutenção



	€		
XS	69,50	1	076440010
S	69,50	1	076440011
M	69,50	1	076440012
L	69,50	1	076440013
XL	69,50	1	076440014
XXL	69,50	1	076440015
XXXL	69,50	1	076440016

## 7654B

Camisola polar, fecho de correr curto, 180 g/m<sup>2</sup>, azul  
95% poliéster, 5% elastano

SUJEITO À DISPONIBILIDADE



	€		
XS	46,50	1	076540100
S	46,50	1	076540101
M	46,50	1	076540102
L	46,50	1	076540103
XL	46,50	1	076540104
XXL	46,50	1	076540105
XXXL	46,50	1	076540106

## 7654N

sweater em micropolar elástico, fecho curto de correr, 180 g/m<sup>2</sup>, preto  
95% poliéster, 5% elastano

SUJEITO À DISPONIBILIDADE



	€		
XS	46,50	1	076540000
S	46,50	1	076540001
M	46,50	1	076540002
L	46,50	1	076540003
XL	46,50	1	076540004
XXL	46,50	1	076540005
XXXL	46,50	1	076540006

## 7657B

Casaco polar, fecho de correr comprido, 280 g/m<sup>2</sup>, azul  
95% poliéster, 5% elastano

SUJEITO À DISPONIBILIDADE



	€		
XS	59,50	1	076570100
S	59,50	1	076570101
M	59,50	1	076570102
L	59,50	1	076570103
XL	59,50	1	076570104
XXL	59,50	1	076570105
XXXL	59,50	1	076570106



### 7657N

sweater em polar elástico, fecho comprido de correr, 280 g/m<sup>2</sup>, preto

95% poliéster, 5% elastano

SUJEITO À DISPONIBILIDADE



TOP line



MAXI	€	W	L
XS	59,50	1	076570000
S	59,50	1	076570001
M	59,50	1	076570002
L	59,50	1	076570003
XL	59,50	1	076570004
XXL	59,50	1	076570005
XXXL	59,50	1	076570006

### 7664N

sweatshirt, fecho de correr comprido, 280 g/m<sup>2</sup>, preto 60% algodão, 40% poliéster

SUJEITO À DISPONIBILIDADE

TOP line



MAXI	€	W	L
XS	54,50	1	076640000
S	54,50	1	076640001
M	54,50	1	076640002
L	54,50	1	076640003
XL	54,50	1	076640004
XXL	54,50	1	076640005
XXXL	54,50	1	076640006

### 7665N

camisola com capuz, fecho de correr comprido, 280 g/m<sup>2</sup>, preto

60% algodão, 40% poliéster

SUJEITO À DISPONIBILIDADE

TOP line



MAXI	€	W	L
XS	58,50	1	076650000
S	58,50	1	076650001
M	58,50	1	076650002
L	58,50	1	076650003
XL	58,50	1	076650004
XXL	58,50	1	076650005
XXXL	58,50	1	076650006



### 7545F

camisa de xadrez em flanela, 100% algodão, 190 g/m<sup>2</sup>



MAXI	€	W	L
XS	41,50	1	075450200
S	41,50	1	075450201
M	41,50	1	075450202
L	41,50	1	075450203
XL	41,50	1	075450204
XXL	41,50	1	075450205
XXXL	41,50	1	075450206

### 7548M

t-shirt estampado moderno, 100% algodão, 150 g/m<sup>2</sup>

SUJEITO À DISPONIBILIDADE



MAXI	€	W	L
XS	26,00	1	075480400
S	26,00	1	075480401
M	26,00	1	075480402
L	26,00	1	075480403
XL	26,00	1	075480404
XXL	26,00	1	075480405
XXXL	26,00	1	075480406



### 7548C

t-shirt estampado clássico, 100% algodão, 150 g/m<sup>2</sup> SUJEITO À DISPONIBILIDADE



MAXI	€	W	L
XS	26,00	1	075480500
S	26,00	1	075480501
M	26,00	1	075480502
L	26,00	1	075480503
XL	26,00	1	075480504
XXL	26,00	1	075480505
XXXL	26,00	1	075480506

### 7550G

t-shirt técnica, em poliéster, 120 g/m<sup>2</sup>, com tecnologia 37.5°, cinzento com detalhes refletivos, em preto e laranja



MAXI	€	W	L
XS	42,00	1	075500400
S	42,00	1	075500401
M	42,00	1	075500402
L	42,00	1	075500403
XL	42,00	1	075500404
XXL	42,00	1	075500405
XXXL	42,00	1	075500406

### 7550N

t-shirt técnica, em poliéster, 120 g/m<sup>2</sup>, com tecnologia 37.5°, preto com detalhes refletivos, em preto e laranja



MAXI	€	W	L
XS	42,00	1	075500500
S	42,00	1	075500501
M	42,00	1	075500502
L	42,00	1	075500503
XL	42,00	1	075500504
XXL	42,00	1	075500505
XXXL	42,00	1	075500506

**7552BL**

polo de trabalho com três botões, em algodão piqué, 200 g/m<sup>2</sup>, azul



	€	👤	📄
XS	19,20	2	075520300
S	19,20	2	075520301
M	19,20	2	075520302
L	19,20	2	075520303
XL	19,20	2	075520304
XXL	19,20	2	075520305
XXXL	19,20	2	075520306

**7553BL**

t-shirt de trabalho, em algodão jersey, 150 g/m<sup>2</sup>, azul



	€	👤	📄
XS	13,00	5	075530300
S	13,00	5	075530301
M	13,00	5	075530302
L	13,00	5	075530303
XL	13,00	5	075530304
XXL	13,00	5	075530305
XXXL	13,00	5	075530306

**7553V**

t-shirt de trabalho em algodão jersey, 150 g/m<sup>2</sup>, verde



	€	👤	📄
XS	13,00	5	075530600
S	13,00	5	075530601
M	13,00	5	075530602
L	13,00	5	075530603
XL	13,00	5	075530604
XXL	13,00	5	075530605
XXXL	13,00	5	075530606

**7552G**

polo de trabalho com três botões, em piqué de algodão, 200 g/m<sup>2</sup>, cinza



	€	👤	📄
XS	19,20	2	075520500
S	19,20	2	075520501
M	19,20	2	075520502
L	19,20	2	075520503
XL	19,20	2	075520504
XXL	19,20	2	075520505
XXXL	19,20	2	075520506

**7553G**

t-shirt de trabalho, em algodão jersey, 150 g/m<sup>2</sup>, cinza



	€	👤	📄
XS	13,00	5	075530400
S	13,00	5	075530401
M	13,00	5	075530402
L	13,00	5	075530403
XL	13,00	5	075530404
XXL	13,00	5	075530405
XXXL	13,00	5	075530406

**7971B**

calças, impermeáveis, em poliéster revestido a PVC com costuras termocoladas, azuis, resistência a colunas de água até 2.000 mm, com cintura elástica e perneiras ajustáveis com molas de pressão

CE



EN 343

**7552N**

polo de trabalho com três botões, em algodão piqué, 200 g/m<sup>2</sup>, preto



	€	👤	📄
XS	19,20	2	075520400
S	19,20	2	075520401
M	19,20	2	075520402
L	19,20	2	075520403
XL	19,20	2	075520404
XXL	19,20	2	075520405
XXXL	19,20	2	075520406

**7553N**

t-shirt de trabalho, em algodão jersey, 150 g/m<sup>2</sup>, preto



	€	👤	📄
XS	13,00	5	075530500
S	13,00	5	075530501
M	13,00	5	075530502
L	13,00	5	075530503
XL	13,00	5	075530504
XXL	13,00	5	075530505
XXXL	13,00	5	075530506

	€	👤	📄
XS	22,80	1	079710200
S	22,80	1	079710201
M	22,80	1	079710202
L	22,80	1	079710203
XL	22,80	1	079710204
XXL	22,80	1	079710205
XXXL	22,80	1	079710206



**7978B**

gabardina impermeável, em poliéster revestido a PVC, com capuz fixo e costuras termocoladas, azul, resistência a colunas de água até 2.000 mm, mangas ajustáveis com molas de pressão

CE



EN 343

	€		
XS	35,50	1	079780200
S	35,50	1	079780201
M	35,50	1	079780202
L	35,50	1	079780203
XL	35,50	1	079780204
XXL	35,50	1	079780205
XXXL	35,50	1	079780206



**Beta**

**UNDERWEAR**
**7996N**

conjunto roupa interior técnica - camisola interior, manga comprida + calças interiores, 92% poliéster, 8% elastano, 160 g/m<sup>2</sup>, preto



	€		
XS-S	42,50	1	079960000
M-L	42,50	1	079960002
XL-XXL	42,50	1	079960004

**7997GN**

camisola interior stretch, manga comprida, 70% poliamida, 28% poliéster com grafeno, 2% elastano, 230 g/m<sup>2</sup> Preto com detalhes cinza Reguladora de temperatura, respirável



	€		
XS-S	41,00	1	079970000
M-L	41,00	1	079970002
XL-XXL	41,00	1	079970004

**7998GN**

calças interiores stretch, 70% poliamida, 28% poliéster com grafeno, 2% elastano, 230 g/m<sup>2</sup> Preto com detalhes cinza Reguladoras de temperatura, respiráveis

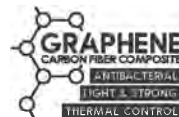

	€		
XS-S	32,00	1	079980000
M-L	32,00	1	079980002
XL-XXL	32,00	1	079980004



**Beta**

# ACCESSORIES

## 7800G

par de joelheiras



7800G € 15,30 1 078000500

## 7980L

gorro com luz LED recarregável e barra 100% acrílico  
luz LED com 3 configurações de luminosidade, até 60 lúmenes  
tamanho único  
preto

- Recarregável através de entrada USB
- Luminosidade: até 60 lúmenes
- Tempo de carga: 80 minutos
- Autonomia: 85 ÷ 290 minutos



7980L € 14,60 10 079800200

## 7980NC

gorro polar, 100% poliéster, reversível (dupla-face), preto camuflagem



7980NC € 13,40 10 079800112

## 7980RN

chapéu impermeável, 100% acrílico, forrado com 3M Thinsulate™, tamanho único  
preto



7980RN € 12,60 10 079800120

## 7981N

gorro impermeável, 100% nylon com revestimento PU, com tratamento hidrorrepelente



Tamanho	€	Qtd	Ref
L = Ø 58 cm	21,90	1	079810158
XL = Ø 60 cm	21,90	1	079810160

## 7982N

boné, 100% poliéster, presilha de ajuste preto



7982N € 10,30 10 079820000

## 7984G

cinto de trabalho, 100% TPE, com fivela metálica cromada, tamanho único; comprimento: 125 cm com possibilidade de encurtar; largura: 35 mm, preto



7984G € 17,80 1 079840525

## 7985N

gola em microfibra com cordão de ajuste, também pode ser utilizada como gorro, preto com detalhes refletivos em cinza



7985N € 12,60 10 079850000

## 7104 90

postes de plástico com base de enchimento



H mm	€	Qtd	Ref
90	29,50	4	071040004

## 7105 6

corrente de barreira em plástico



Ø mm	L m	€	Qtd	Ref
6	25	71,00	1	071050006

## 7109A

sinas de alerta em alumínio



Ref	H mm	€	Qtd	Ref
7109A 1	140	12,40	1	071090001
7109A 2	140	12,40	1	071090002
7109A 3	140	12,40	1	071090003
7109A 4	140	12,40	1	071090004

## 7109D

sinas de proibição



Ref	H mm	€	Qtd	Ref
7109D 1	115	12,40	1	071090051
7109D 2	115	12,40	1	071090052
7109D 3	115	12,40	1	071090053



### 7061TC

óculos de segurança com lentes transparentes em policarbonato

CE EASY



EN166:2001  
EN170  
2C-1.2 1F

7061TC € 9,90 1 070610001

### 7076BC

óculos de segurança com lentes transparentes em policarbonato

CE SPORT



EN166:2001  
EN172  
5-1.7 1F

7076BC € 22,50 1 070760009

### 7076BD

óculos de segurança com lentes transparentes em policarbonato

CE SPORT



EN166:2001  
EN172  
5-3.1 1F

7076BD € 22,50 1 070760019

### 7076BP

óculos de segurança com lentes transparentes em policarbonato

CE SPORT



EN ISO 12312-1:2013+A1:2015  
EN 1836  
3P

7076BP € 35,50 1 070760029

### 7076BU

óculos de segurança com lentes cor de laranja em policarbonato

CE



EN ISO 12311:2013  
UV 500

7076BU € 18,50 1 070760039

### 7093BC

óculos de segurança com lentes transparentes em policarbonato

CE IMPACT



EN166:2001  
EN170  
2C-1.2 1F

7093BC € 33,50 1 070930009

### 7093BD

óculos de segurança com lentes transparentes em policarbonato

CE IMPACT



EN166:2001  
EN172  
5-3.1 1F

7093BD € 33,50 1 070930019



### C62M/WW

manequim, tamanho realista, base em metal



185 cm

C62M/WW € 260,00 1 062000362

### C64

expositor de parede para vestuário e calçado, vazio



2400 mm

560 mm

L	€	1	064000021
1 m	1.460,00	1	064000021
2 m	2.640,00	1	064000022
3 m	3.820,00	1	064000023
4 m	5.000,00	1	064000024



## C64G

expositor tipo "gondola" para vestuário e calçado, vazio

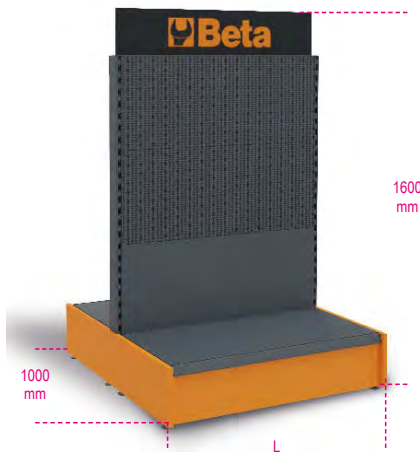

L	€	Unidade	Código
1 m	1.790,00	1	06400051
2 m	3.250,00	1	06400052

## C64CW

vestiário



C64CW	€	Unidade	Código
	620,00	1	064000610

## 6200AP/S10

conjunto de 10 cabides



6200AP/S10	€	Unidade	Código
	44,50	1	062000331

## 6800BA



6800BA	€	Unidade	Código
	130,00	1	068000130

## 6800RS



6800RS	€	Unidade	Código
	112,00	1	068000135

## 6888GS

gancho para calçado para expositor C64



6888GS	€	Unidade	Código
170x120 mm	28,00	2	068880122

## 6888GW

gancho para expositor C64



6888GW	€	Unidade	Código
400 mm	7,80	2	068880121

## 9562TB

tapete para experimentar sapatos, com parte de trás antiderrapante em borracha



9562TB	L mm	H mm	€	Unidade	Código
	800	600	49,50	1	095620500

## 9565S

Bidão em folha de aço, com assento em imitação de cabedal amovível



9565S	H cm	ø cm	€	Unidade	Código
	60	38	219,00	1	095650300





# Robur

Desde 1930 que a Robur produz uma linha de acessórios para cabos aliando-se aos mais altos padrões de qualidade reconhecidos nas ferramentas Beta, tornando-se num complemento produtivo desta.

A experiência, organização e tecnologia são os requisitos chave do contínuo desenvolvimento que a exigência do mercado determina.

Desde 1984 que a Robur foi sediada em Sulmona numa moderna unidade de produção.



**Embalagens especiais  
com blister**

### CARGA MÁXIMA DE UTILIZAÇÃO

- WLL:** limite de carga de trabalho (para acessórios de elevação)
- WFL:** força de trabalho limite (para outros acessórios que não de elevação)
- BF:** força máxima alcançada durante o teste de tracção estático
- LC:** carga de trabalho

Novidade 2025

**8143SL**

diferencial de alavanca com gancho com bloqueio de segurança

CE



EN13157

#### CARACTERÍSTICAS TÉCNICAS

- Fator de segurança: 4
- Etiqueta de identificação de série
- CERTIFICADOS DISPONÍVEIS**
- Certificado do fabricante
- Declaração de Conformidade CE
- Relatório de ensaio UNI EN10204 tipo 2.2
- Especificações técnicas do produto

Dimensão

Preço unitário

WLL	Lm	sfuerzo / effort	€	Código
1	3	44	324,00	081430310
2	3	44	428,00	081430320
1	6	44	433,00	081430410
2	6	44	565,00	081430420

Quantidade por caixa



## TENSORES DE ALTA RESISTÊNCIA

Os tensores de alta resistência da Robur foram concebidos para tensionar cabos e fios de forma adequada em **aplicações estruturais**, incluindo ancoragens, estruturas de tração e sistemas de fixação.

São também utilizados em sistemas de **elevação** específicos para movimentação de cargas.

Alta **resistência mecânica**, fator de segurança de 5:1, **galvanização por imersão a quente** protegendo as superfícies contra danos climáticos, **aço de alta qualidade e tratamento térmico** aplicado ao corpo e terminais tornam os nossos tensores de alta resistência **indispensáveis, para garantir a segurança em cada projeto.**



### 8105

tensores com 2 olhalis em aço ligeiro galvanizado a quente

CE



#### CARACTERÍSTICAS TÉCNICAS

- fator de segurança: 5
- tratamento térmico, corpo: normalizador
- tratamento térmico, olhalis: endurecido e temperado

#### TESTES LABORATORIAIS

- análise química
- ensaio de tração

#### CERTIFICADOS DISPONÍVEIS

- Especificações técnicas
- Relatório de ensaio UNI EN10204 tipo 2.2

ØxE	≈	WLL	€		
"	mm	kg			
3/8x6	M10x150	540	15,70	5	081050010
1/2x6	M12x150	1000	26,00	5	081050011
1/2x9	M12x230	1000	33,50	5	081050012
5/8x6	M16x150	1590	40,00	2	081050014
5/8x9	M16x230	1590	49,00	2	081050016
5/8X12	M16X300	1590	59,00	2	081050015
3/4x6	M20x150	2360	63,50	2	081050017
3/4x9	M20x230	2360	74,00	2	081050020
3/4x12	M20x300	2360	88,00	2	081050018
3/4x18	M20x460	2360	116,00	2	081050021
7/8x12	M22x300	3270	125,00	1	081050022
1x6	M24x150	4540	132,00	1	081050024
1x12	M24x300	4540	190,00	1	081050025
1x18	M24x460	4540	223,00	1	081050026
1.1/4x12	M33x300	6900	324,00	1	081050031
1.1/4x18	M33x460	6900	334,00	1	081050032
1.1/4x24	M33x610	6900	453,00	1	081050033
1.1/2x12	M39x300	9710	401,00	1	081050034
1.1/2x18	M39x460	9710	487,00	1	081050035
1.3/4x18	M45x460	12700	740,00	1	081050036

## Embalagens especiais com blister



ØxE		€		
3/8x6	1	17,20	1	081059010
1/2x9	1	35,00	1	081059012

### 8109

tensores com 2 forquilhas em aço ligeiro galvanizado a quente

CE

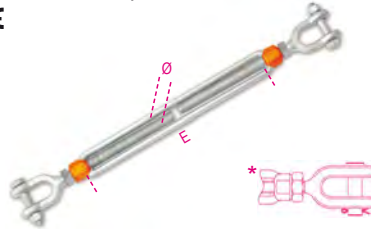

#### CARACTERÍSTICAS TÉCNICAS

- fator de segurança: 5
- tratamento térmico, corpo: normalizador
- tratamento térmico, forquilhas: endurecido e temperado

#### TESTES LABORATORIAIS

- análise química
- ensaio de tração

#### CERTIFICADOS DISPONÍVEIS

- Especificações técnicas
- Relatório de ensaio UNI EN10204 tipo 2.2

ØxE	≈	WLL	€		
"	mm	kg			
3/8x6	M10x150	540	20,40	5	081090010
1/2x6	M12x150	1000	34,00	5	081090011
1/2x9	M12x230	1000	40,50	5	081090012
1/2x12	M12x300	1000	51,50	5	081090013
5/8x6	M16x150	1590	62,00	2	081090015
5/8x9	M16x230	1590	73,50	2	081090016
5/8X12	M16X300	1590	82,00	2	081090017
3/4x6	M20x150	2360	86,50	2	081090018
3/4x9	M20x230	2360	100,00	2	081090020
3/4x12	M20x300	2360	112,00	2	081090019
3/4x18	M20x460	2360	133,00	2	081090021
7/8x12	M22x300	3270	167,00	1	081090022
7/8x18	M22x460	3270	202,00	1	081090023
1x6	M24x150	4540	166,00	1	081090024
1x12	M24x300	4540	238,00	1	081090025
1x18	M24x460	4540	274,00	1	081090026
* 1.1/4x12	M33x300	6900	385,00	1	081090031
* 1.1/4x18	M33x460	6900	432,00	1	081090032
* 1.1/4x24	M33x610	6900	600,00	1	081090033
* 1.1/2X12	M39x300	9710	560,00	1	081090034
* 1.1/2x18	M39x460	9710	640,00	1	081090038
* 1.1/2x24	M39x610	9710	770,00	1	081090039
* 1.3/4X18	M45x460	12700	935,00	1	081090036

## Embalagens especiais com blister



ØxE		€		
3/8x6	1	21,80	1	081099010
1/2x9	1	41,50	1	081099012



### 8110

esticador de olhal e manilha, aço de elevada resistência, galvanizado a quente

CE

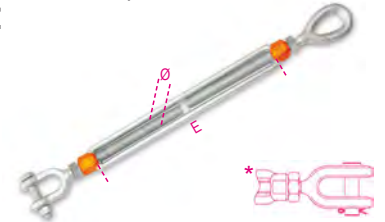

#### CARACTERÍSTICAS TÉCNICAS

- fator de segurança: 5
- tratamento estrutura (corpo): normalizador
- tratamento olhal: reforçado e temperado

#### TESTES LABORATORIAIS

- análise química
- ensaio de tensão

#### CERTIFICADOS DISPONÍVEIS

- Especificações técnicas
- Relatório de teste UNI EN10204 tipo 2.2
- Certificado de inspeção UNI EN10204 tipo 3.1
- Declaração de Conformidade CE

ØxE	≈	WLL	€		
"	mm	kg			
3/8x6	M10x150	540	18,60	5	081100004
1/2x6	M12x150	1000	29,50	5	081100006
1/2x9	M12x230	1000	36,50	5	081100010
5/8x6	M16x150	1590	51,50	2	081100014
5/8x9	M16x230	1590	60,00	2	081100015
5/8x12	M16x300	1590	70,00	2	081100016
3/4x6	M20x150	2360	76,00	2	081100019
3/4x9	M20x230	2360	87,50	2	081100020
3/4x12	M20x300	2360	99,50	2	081100021
7/8X12	M22x300	3270	145,00	1	081100022
1x6	M24x150	4540	149,00	1	081100027
1x12	M24x300	4540	214,00	1	081100029
* 1.1/4x12	M33x300	6900	356,00	1	081100034
* 1.1/4x18	M33x460	6900	422,00	1	081100035
* 1.1/4x24	M33x610	6900	525,00	1	081100036
* 1.1/2x12	M39x300	9710	499,00	1	081100038
* 1.1/2x18	M39x460	9710	565,00	1	081100039
* 1.3/4x18	M45x460	12700	865,00	1	081100044

Gancho com pino de segurança

Outros tamanhos disponíveis a pedido



# TENSORES

O design original dos tensores **Robur** é extremamente popular entre os designers e engenheiros estruturais italianos, baseado em tolerâncias dimensionais precisas, valores de resistência superiores aos modelos DIN 1480, bem como rastreabilidade garantida tanto pelo fabricante como pelo código de identificação no corpo.

A galvanização eletrolítica de qualidade, com depósitos uniformes isentos de crómio hexavalente, resulta numa boa resistência às intempéries e aparência cuidada dos elementos estruturais expostos.



## 8005Z

tensores de dois olhais, zincados

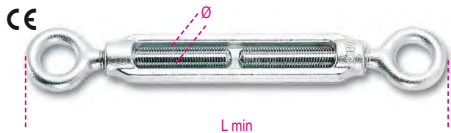

### CARACTERÍSTICAS TÉCNICAS

- factor de segurança: 4
- TESTES LABORATORIAIS
- análise química
- ensaio de tracção
- CERTIFICADOS DISPONÍVEIS
- Especificações técnicas
- Relatório de ensaio UNI EN10204 tipo 2.2
- Declaração de Conformidade CE

Ø mm	≈"	L min mm	WFL kg	€	📦	📄
M5	3/16	118	115	2,62	400	080050105
M6	1/4	130	160	2,89	300	080050106
M8	5/16	158	300	4,40	200	080050108
M10	3/8	192	470	6,40	100	080050110
M11	7/16	206	580	8,30	80	080050111
M12	1/2	226	690	9,80	60	080050112
M14	9/16	256	940	13,30	15	080050114
M16	5/8	290	1290	20,10	10	080050116
M18	11/16	358	1660	29,50	1	080050118
M20	3/4	358	2130	33,50	1	080050120
M22	7/8	400	2630	46,00	1	080050122
M24	1"	436	3060	57,50	1	080050124
M27	1 1/8	474	4000	83,50	1	080050125
M30	1 3/16	498	4860	101,00	1	080050130
M33	1 1/4	516	6040	118,00	1	080050126
M36	1 3/8	532	6500	146,00	1	080050136
M39	1 1/2	544	7900	172,00	1	080050139

## confeção especial



Ø mm	≈"	📦	€	📄
M5	3/16	30	88,50	1 080050705
M6	1/4	30	98,00	1 080050706
M8	5/16	20	99,50	1 080050708
M10	3/8	15	107,00	1 080050710
M11	7/16	15	140,00	1 080050711
M12	1/2	15	164,00	1 080050712

## Embalagens especiais com blister

Ø mm	📦	€	📄
M5	2	6,20	1 080059305
M6	2	7,10	1 080059306
M8	1	5,90	1 080059108
M10	1	7,70	1 080059110
M11	1	10,00	1 080059111
M12	1	11,20	1 080059112
M14	1	14,40	1 080059114
M16	1	21,50	1 080059116

## 8005Tz

tensor de dois olhais, zincado



### CARACTERÍSTICAS TÉCNICAS

- factor de segurança: 4
- TESTES LABORATORIAIS
- análise química
- ensaio de tracção
- CERTIFICADOS DISPONÍVEIS
- Especificações técnicas
- Relatório de ensaio UNI EN10204 tipo 2.2
- Declaração de Conformidade CE

Ø mm	≈"	WFL kg	€	📦	📄
M12	1/2	690	13,20	15	080050512
M16	5/8	1290	22,70	1	080050516
M20	3/4	2130	32,50	1	080050520
M24	1"	3060	59,50	1	080050524
M27	1 1/8	4000	81,00	1	080050527
M30	1.3/16	4860	93,50	1	080050530
M36	1.3/8	6500	150,00	1	080050536

## Embalagens especiais com blister

Ø mm	📦	€	📄
M12	1	15,70	1 080059512

# Robur

# Robur

## 8006Z

tensores de olhal e gancho, zincados

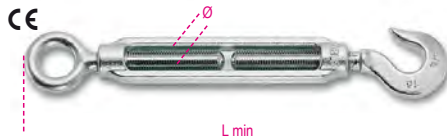

### CARACTERÍSTICAS TÉCNICAS

- factor de segurança: 4
- TESTES LABORATORIAIS
- análise química
- ensaio de tracção
- CERTIFICADOS DISPONÍVEIS
- Especificações técnicas
- Relatório de ensaio UNI EN10204 tipo 2.2
- Declaração de Conformidade CE

Ø mm	≈"	L min mm	WFL kg	€	📦	📄
M5	3/16	121	25	2,78	400	080060105
M6	1/4	132	45	3,05	250	080060106
M8	5/16	170	95	4,65	180	080060108
M10	3/8	204	140	6,90	100	080060110
M11	7/16	221	165	9,00	15	080060111
M12	1/2	244	300	10,70	15	080060112
M14	9/16	284	420	15,30	10	080060114
M16	5/8	322	570	22,60	1	080060116
M18	11/16	373	700	32,50	1	080060118
M20	3/4	391	900	39,50	1	080060120
M22	7/8	433	1100	52,50	1	080060122
M24	1"	470	1300	70,50	1	080060124
M27	1 1/8	503	2300	96,00	1	080060127

## confeção especial



Ø mm	≈"	📦	€	📄
M5	3/16	30	94,00	1 080060705
M6	1/4	30	104,00	1 080060706
M8	5/16	20	105,00	1 080060708
M10	3/8	15	117,00	1 080060710

## Embalagens especiais com blister

Ø mm	📦	€	📄
M5	2	7,00	1 080069305
M6	2	7,80	1 080069306
M8	1	6,00	1 080069108
M10	1	8,20	1 080069110
M11	1	10,50	1 080069111
M12	1	11,80	1 080069112
M14	1	16,90	1 080069114

## 8007Z

tensores de dois ganchos, zincados

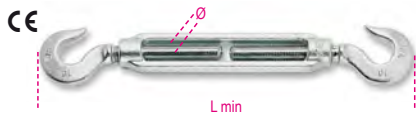

### CARACTERÍSTICAS TÉCNICAS

- factor de segurança: 4
- TESTES LABORATORIAIS
- análise química
- ensaio de tracção
- CERTIFICADOS DISPONÍVEIS
- Especificações técnicas
- Relatório de ensaio UNI EN10204 tipo 2.2
- Declaração de Conformidade CE

Ø mm	≈	L min mm	WFL kg	€	📦	🚚
M5	3/16	124	25	2,94	30	080070105
M6	1/4	134	45	3,20	30	080070106
M8	5/16	181	95	4,90	20	080070108
M10	3/8	211	140	7,50	15	080070110
M11	7/16	231	165	9,80	15	080070111
M12	1/2	262	300	11,70	15	080070112
M14	9/16	312	420	17,40	1	080070114
M16	5/8	354	570	25,00	1	080070116
M18	11/16	388	700	35,50	1	080070118
M20	3/4	424	900	46,00	1	080070120
M22	7/8	466	1100	59,00	1	080070122
M24	1"	504	1300	83,50	1	080070124
M27	1 1/8	532	2300	109,00	1	080070127

Embalagens especiais com blister



Ø mm	≈	€	📦	🚚
M5	2	7,40	1	080079305
M6	2	7,80	1	080079306
M8	1	5,90	1	080079108
M10	1	8,00	1	080079110
M11	1	10,80	1	080079111
M12	1	12,80	1	080079112

## 8008N

tensores de dois troncos, negros

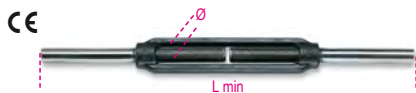

### CARACTERÍSTICAS TÉCNICAS

- factor de segurança: 4
- TESTES LABORATORIAIS
- análise química
- ensaio de tracção
- CERTIFICADOS DISPONÍVEIS
- Especificações técnicas
- Relatório de ensaio UNI EN10204 tipo 2.2
- Declaração de Conformidade CE

Ø mm	≈	L min mm	WFL kg	€	📦	🚚
M5	3/16	160	115	2,56	30	080080205
M6	1/4	180	160	2,83	30	080080206
M8	5/16	210	300	3,90	20	080080208
M10	3/8	250	470	5,30	15	080080210
M12	1/2	280	690	7,90	15	080080212
M14	9/16	340	940	11,10	5	080080214
M16	5/8	380	1290	14,90	5	080080216
M18	11/16	410	1660	22,10	3	080080218
M20	3/4	440	2130	26,00	3	080080220
M22	7/8	480	2630	32,50	2	080080222
M24	1"	520	3060	42,50	2	080080224
M27	1 1/8	560	4000	66,50	1	080080227
M30	1 3/16	560	4860	83,50	1	080080230
M33	1 1/4	600	6040	89,50	1	080080233
M36	1 3/8	600	6500	116,00	1	080080236
M39	1 1/2	600	7900	132,00	1	080080239

Embalagens especiais com blister



Ø mm	≈	€	📦	🚚
M5	2	7,10	1	080089305
M6	2	7,20	1	080089306
M8	1	5,30	1	080089208
M10	1	7,00	1	080089210
M12	1	8,90	1	080089212
M14	1	12,40	1	080089214

## 8008TZN

Tensores de tubos DIN 1478, terminais coloridos, corpo galvanizado DIN 1478



### CARACTERÍSTICAS TÉCNICAS

- factor de segurança: 4
- TESTES LABORATORIAIS
- análise química
- ensaio de tracção
- CERTIFICADOS DISPONÍVEIS
- Especificações técnicas
- Relatório de ensaio UNI EN10204 tipo 2.2
- Declaração de Conformidade CE

Ø mm	≈	WFL kg	€	📦	🚚
M12	1/2	690	10,90	10	080080512
M16	5/8	1290	17,90	1	080080516
M20	3/4	2130	26,50	1	080080520
M24	1	3060	46,50	1	080080524
M27	1.1/8	4000	68,00	1	080080527
M30	1.3/16	4860	80,50	1	080080530
M36	1.3/8	6500	126,00	1	080080536

## 8009Z

tensores de duas forquilhas, zincados

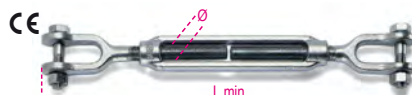

### CARACTERÍSTICAS TÉCNICAS

- factor de segurança: 4
- TESTES LABORATORIAIS
- análise química
- ensaio de tracção
- CERTIFICADOS DISPONÍVEIS
- Especificações técnicas
- Relatório de ensaio UNI EN10204 tipo 2.2
- Declaração de Conformidade CE

Ø mm	≈	L min mm	WFL kg	€	📦	🚚
M8	5/16	192	300	14,40	15	080090008
M10	3/8	234	470	17,30	15	080090010
M12	1/2	274	690	23,20	15	080090012
M14	9/16	342	940	32,00	1	080090014
M16	5/8	372	1290	37,50	1	080090016
M18	11/16	406	1660	55,50	1	080090018
M20	3/4	406	2130	58,50	1	080090020
M22	7/8	466	2630	81,00	1	080090022
M24	1"	486	3060	94,50	1	080090024
M27	1 1/8	510	4000	148,00	1	080090027
M30	1 3/16	566	4860	190,00	1	080090030

packs especiais



Ø mm	≈	€	📦	🚚
M8	5/16	81,00	1	080090708
M10	3/8	97,50	1	080090710
M12	1/2	130,00	1	080090712

Embalagens especiais com blister



Ø mm	≈	€	📦	🚚
M8	1	16,40	1	080099008
M10	1	18,70	1	080099010
M12	1	25,00	1	080099012

## 8009TZ

tensores de duas forquilhas, corpo tubular, DIN 1478 galvanizados



### CARACTERÍSTICAS TÉCNICAS

- coeficiente de segurança: 4
- TESTES LABORATORIAIS
- análise química
- teste elasticidade
- CERTIFICADOS DISPONÍVEIS
- Especificações do Produto
- Relatório de Teste UNI EN10204 tipo 2.2 • Declaração de Conformidade CE

Ø mm	≈	WFL kg	€	📦	🚚
M12	1/2	690	26,00	10	080090512
M16	5/8	1290	40,50	1	080090516
M20	3/4	2130	57,50	1	080090520
M24	1	3060	96,00	1	080090524
M27	1.1/8	4000	145,00	1	080090527
M30	1.3/16	4860	183,00	1	080090530

Embalagens especiais com blister



Ø mm	≈	€	📦	🚚
M12	1	26,00	1	080099512





## 8010Z

tensores de olhal e forquilha, zincados



### CARACTERÍSTICAS TÉCNICAS

• fator de segurança: 4

### TESTES LABORATORIAIS

• análise química

• ensaio de tração

### CERTIFICADOS DISPONÍVEIS

• Especificações técnicas

• Relatório de ensaio UNI EN10204 tipo 2.2

• Declaração de Conformidade CE

Ø mm	≈	L min mm	WFL kg	€	📦	🚚
M8	5/16	175	300	9,50	20	080100008
M10	3/8	215	470	11,80	15	080100010
M12	1/2	250	690	16,50	10	080100012
M14	9/16	299	940	22,70	10	080100014
M16	5/8	331	1290	29,00	1	080100016
M18	11/16	382	1660	42,00	1	080100018
M20	3/4	382	2130	46,00	1	080100020
M22	7/8	433	2630	63,50	1	080100022
M24	1"	461	3060	76,00	1	080100024
M27	1 1/8	492	4000	116,00	1	080100027
M30	1 3/16	529	4860	146,00	1	080100030

Embalagens especiais com blister



Ø mm	📦	€	🚚	🚚
M8	1	10,60	1	080109008
M10	1	13,10	1	080109010
M12	1	17,80	1	080109012
M14	1	25,00	1	080109014

## 8010TZ

Tensores de olhal e forquilha, zincados DIN 1478



### CARACTERÍSTICAS TÉCNICAS

• fator de segurança: 4

### TESTES LABORATORIAIS

• análise química

• ensaio de tração

### CERTIFICADOS DISPONÍVEIS

• Especificações técnicas

• Relatório de ensaio UNI EN10204 tipo 2.2

• Declaração de Conformidade CE

Ø mm	≈	WFL kg	€	📦	🚚
M12	1/2	690	19,30	10	080100612
M16	5/8	1290	31,50	1	080100616
M20	3/4	2130	45,50	1	080100620
M24	1	3060	77,50	1	080100624
M27	1.1/8	4000	113,00	1	080100627
M30	1.3/16	4860	138,00	1	080100630

## 8011Z

tensor com gancho e forquilha, galvanizado



### CARACTERÍSTICAS TÉCNICAS

• fator de segurança: 4

### TESTES LABORATORIAIS

• análise química

• ensaio de tração

### CERTIFICADOS DISPONÍVEIS

• Especificações técnicas

• Relatório de ensaio UNI EN10204 tipo 2.2

• Declaração de Conformidade CE

Ø mm	≈	L min mm	WFL kg	€	📦	🚚
M12	1/2	270	300	14,90	1	080110112
M16	5/8	360	570	30,50	1	080110116
M20	3/4	420	900	51,00	1	080110120
M24	1"	490	1300	85,50	1	080110124
M27	1 1/8	500	2300	118,00	1	080110127

## 8011TZ

tensor com gancho e forquilha, DIN 1478, galvanizado



### CARACTERÍSTICAS TÉCNICAS

• fator de segurança: 4

### TESTES LABORATORIAIS

• análise química

• ensaio de tração

### CERTIFICADOS DISPONÍVEIS

• Especificações técnicas

• Relatório de ensaio UNI EN10204 tipo 2.2

• Declaração de Conformidade CE

Ø mm	≈	L min mm	WFL kg	€	📦	🚚
M12	1/2	260	300	17,10	1	080110612
M16	5/8	350	570	31,00	1	080110616
M20	3/4	400	900	47,50	1	080110620
M24	1"	490	1300	82,00	1	080110624
M27	1 1/8	500	2300	109,00	1	080110627

## 8001Z

corpos para tensores, zincados



### CARACTERÍSTICAS TÉCNICAS

• fator de segurança: 4

• código de identificação

### TESTES LABORATORIAIS

• análise química

• ensaio de tração

### CERTIFICADOS DISPONÍVEIS

• Especificações técnicas

• Relatório de ensaio UNI EN10204 tipo 2.2

• Declaração de Conformidade CE

Ø mm	≈	L mm	WFL kg	€	📦	🚚
M5	3/16	80	115	1,57	100	080010105
M6	1/4	80	160	1,65	100	080010106
M8	5/16	105	300	2,58	25	080010108
M10	3/8	125	470	3,30	20	080010110
M11	7/16	135	580	4,10	15	080010111
M12	1/2	140	690	4,40	20	080010112
M14	9/16	170	940	6,30	15	080010114
M16	5/8	190	1290	8,50	15	080010116
M18	11/16	205	1660	13,50	10	080010118
M20	3/4	220	2130	15,50	10	080010120

Ø mm	≈	L mm	WFL kg	€	📦	🚚
M22	7/8	240	2630	19,70	8	080010122
M24	1"	260	3060	24,00	5	080010124
M27	1 1/8	270	4000	37,50	1	080010127
M30	1 3/16	280	4860	47,50	1	080010130
M33	1 1/4	290	6040	52,50	1	080010133
M36	1 3/8	300	6500	67,50	1	080010139
M39	1 1/2	300	7900	80,50	1	080010199

Embalagens especiais com blister



Ø mm	📦	€	🚚	🚚
M5	2	4,75	1	080019305
M6	2	5,20	1	080019306
M8	1	4,10	1	080019108
M10	1	4,80	1	080019110
M11	1	5,80	1	080019111
M12	1	6,00	1	080019112
M14	1	8,00	1	080019114
M16	1	10,20	1	080019116
M18	1	15,10	1	080019118
M20	1	16,90	1	080019120
M22	1	21,40	1	080019122
M24	1	25,50	1	080019124

## 8001TZ

corpo para tensores, zincado



DIN 1478

### CARACTERÍSTICAS TÉCNICAS

• fator de segurança: 4

• código de identificação

### TESTES LABORATORIAIS

• análise química

• ensaio de tração

### CERTIFICADOS DISPONÍVEIS

• Especificações técnicas

• Relatório de ensaio UNI EN10204 tipo 2.2

• Declaração de Conformidade CE

Ø mm	≈	L mm	WFL kg	€	📦	🚚
M12	1/2	125	690	7,40	10	080010512
M16	5/8	170	1290	11,20	5	080010516
M20	3/4	200	2130	14,80	5	080010520
M24	1	255	3060	26,00	3	080010524
M27	1.1/8	255	4000	35,00	1	080010527
M30	1.3/16	255	4860	39,50	1	080010530
M36	1.3/8	295	6500	71,00	1	080010536
M42	1.5/8	330	9700	100,00	1	080010542

Embalagens especiais com blister



Ø mm	📦	€	🚚	🚚
M12	1	8,80	1	080019512
M16	1	12,40	1	080019516
M20	1	16,10	1	080019520
M24	1	27,00	1	080019524





## 8002ZD

olhas para tensores, de rosca direita, zincados

disponível com rosca esquerda, a pedido



### CARACTERÍSTICAS TÉCNICAS

• factor de segurança: 4

### TESTES LABORATORIAIS

• análise química

• ensaio de tracção

### CERTIFICADOS DISPONÍVEIS

• Especificações técnicas

• Relatório de ensaio UNI EN10204 tipo 2.2

Ø mm	≈ "	E mm	WFL kg	€	📦	🚚
M5	3/16	37	115	0,55	200	080020105
M6	1/4	40	160	0,66	150	080020106
M8	5/16	52	300	0,98	100	080020108
M10	3/8	60	470	1,57	100	080020110
M11	7/16	65	580	2,22	1	080020111
M12	1/2	72	690	2,78	50	080020112
M14	9/16	85	940	3,45	1	080020114
M16	5/8	95	1290	5,80	1	080020116
M18	11/16	103	1660	8,50	1	080020118
M20	3/4	110	2130	9,50	1	080020120
M22	7/8	120	2630	13,90	1	080020122
M24	1"	130	3060	17,60	1	080020124
M27	1 1/8	135	4000	24,20	1	080020127
M30	1 3/16	140	4860	28,50	1	080020130
M33	1 1/4	148	6040	34,50	1	080020133
M36	1 3/8	150	6500	41,50	1	080020198
M39	1 1/2	150	7900	48,50	1	080020199

Ø mm	≈ "	E mm	WFL kg	€	📦	🚚
M5	3/16	37	115	0,55	1	080020305
M6	1/4	40	160	0,66	1	080020306
M8	5/16	52	300	0,98	1	080020308
M10	3/8	60	470	1,57	1	080020310
M11	7/16	65	580	2,22	1	080020311
M12	1/2	72	690	2,78	1	080020312
M14	9/16	85	940	3,45	1	080020314
M16	5/8	95	1290	5,80	1	080020316
M18	11/16	103	1660	8,50	1	080020318
M20	3/4	110	2130	9,50	1	080020320
M22	7/8	120	2630	13,90	1	080020322
M24	1"	130	3060	17,60	1	080020324
M27	1 1/8	135	4000	24,20	1	080020327
M30	1 3/16	140	4860	28,50	1	080020330
M33	1 1/4	148	6040	34,50	1	080020333
M36	1 3/8	150	6500	41,50	1	080020398
M39	1 1/2	150	7900	48,50	1	080020399



## 8003ZD

ganchos para tensores, de rosca direita, zincados

disponível com rosca esquerda, a pedido



### CARACTERÍSTICAS TÉCNICAS

• factor de segurança: 4

### TESTES LABORATORIAIS

• análise química

• ensaio de tracção

### CERTIFICADOS DISPONÍVEIS

• Especificações técnicas

• Relatório de ensaio UNI EN10204 tipo 2.2

Ø mm	≈ "	E mm	WFL kg	€	📦	🚚
M5	3/16	40	25	0,72	150	080030105
M6	1/4	40	45	0,82	120	080030106
M8	5/16	52	95	1,21	100	080030108
M10	3/8	60	140	2,16	70	080030110
M11	7/16	65	165	2,94	1	080030111
M12	1/2	70	300	3,75	30	080030112
M14	9/16	85	420	5,80	1	080030114
M16	5/8	95	570	8,70	1	080030116
M18	11/16	103	700	11,60	1	080030118
M20	3/4	110	900	15,70	1	080030120
M22	7/8	120	1100	20,40	1	080030122
M24	1"	130	1300	31,00	1	080030124
M27	1 1/8	135	2300	37,00	1	080030127

Ø mm	≈ "	WFL kg	E mm	€	📦	🚚
M5	3/16	40	25	0,72	1	080030305
M6	1/4	40	45	0,82	1	080030306
M8	5/16	52	95	1,21	1	080030308
M10	3/8	60	140	2,16	1	080030310
M11	7/16	65	165	2,94	1	080030311
M12	1/2	70	300	3,75	1	080030312
M14	9/16	85	420	5,80	1	080030314
M16	5/8	95	570	8,70	1	080030316
M18	11/16	103	700	11,60	1	080030318
M20	3/4	110	900	15,70	1	080030320
M22	7/8	120	1100	20,40	1	080030322
M24	1"	130	1300	31,00	1	080030324
M27	1 1/8	135	2300	37,00	1	080030327

## 8004ND

tensores de tronco rosca direita - negros

Rosca esquerda a pedido



### CARACTERÍSTICAS TÉCNICAS

• factor de segurança: 4

### TESTES LABORATORIAIS

• análise química

• ensaio de tracção

### CERTIFICADOS DISPONÍVEIS

• Especificações técnicas

• Relatório de ensaio UNI EN10204 tipo 2.2

Ø mm	≈ "	E mm	WFL kg	€	📦	🚚
M5	3/16	40	115	0,57	1	080040005
M6	1/4	44	160	0,66	1	080040006
M8	5/16	53	300	0,78	1	080040008
M10	3/8	63	470	1,16	1	080040010
M12	1/2	70	690	1,93	1	080040012
M14	9/16	85	940	2,65	1	080040014
M16	5/8	95	1290	3,65	1	080040016
M18	11/16	103	1660	4,95	1	080040018
M20	3/4	110	2130	6,30	1	080040020
M22	7/8	120	2630	7,70	1	080040022
M24	1"	130	3060	10,90	1	080040024
M27	1 1/8	135	4000	17,50	1	080040027
M30	1 3/16	140	4860	21,60	1	080040030
M33	1 1/4	150	6040	22,30	1	080040033
M36	1 3/8	150	6500	29,50	1	080040098
M39	1 1/2	150	7900	31,50	1	080040099

Ø mm	≈ "	E mm	WFL kg	€	📦	🚚
M5	3/16	40	115	0,57	1	080040105
M6	1/4	44	160	0,66	1	080040106
M8	5/16	53	300	0,78	1	080040108
M10	3/8	63	470	1,16	1	080040110
M12	1/2	70	690	1,93	1	080040112
M14	9/16	85	940	2,65	1	080040114
M16	5/8	95	1290	3,65	1	080040116
M18	11/16	103	1660	4,95	1	080040118
M20	3/4	110	2130	6,30	1	080040120
M22	7/8	120	2630	7,70	1	080040122
M24	1"	130	3060	10,90	1	080040124
M27	1 1/8	135	4000	17,50	1	080040127
M30	1 3/16	140	4860	21,60	1	080040130
M33	1 1/4	150	6040	22,30	1	080040133
M36	1 3/8	150	6500	29,50	1	080040198
M39	1 1/2	150	7900	31,50	1	080040199



## 8009FD

tensores de forquilha  
rosca direita - zincados  
Rosca esquerda a pedido

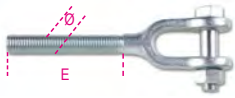

### CARACTERÍSTICAS TÉCNICAS

- factor de segurança: 4
- TESTES LABORATORIAIS
- análise química
- ensaio de tracção
- CERTIFICADOS DISPONÍVEIS
- Especificações técnicas
- Relatório de ensaio UNI EN10204 tipo 2.2

Ø mm	≈ "	E mm	WFL kg	€	📦	🚚
M8	5/16	53	300	6,20	1	080090208
M10	3/8	63	470	7,20	1	080090210
M12	1/2	70	690	9,80	1	080090212
M14	9/16	85	940	13,50	1	080090214
M16	5/8	95	1290	15,30	1	080090216
M18	11/16	103	1660	21,60	1	080090218
M20	3/4	110	2130	22,30	1	080090220
M22	7/8	120	2630	31,50	1	080090222
M24	1"	130	3060	36,50	1	080090224
M27	1 1/8	135	4000	57,50	1	080090227
M30	1 3/16	140	4860	74,50	1	080090230

### forquilhas para tensores direitos - zincadas

Ø mm	≈ "	WFL kg	G mm	€	📦	🚚
M8	5/16	53	300	6,20	1	080090408
M10	3/8	63	470	7,20	1	080090410
M12	1/2	70	690	9,80	1	080090412
M14	9/16	85	940	13,50	1	080090414
M16	5/8	95	1290	15,30	1	080090416
M18	11/16	103	1660	21,60	1	080090418
M20	3/4	110	2130	22,30	1	080090420
M22	7/8	120	2630	31,50	1	080090422
M24	1"	130	3060	36,50	1	080090424
M27	1 1/8	135	4000	57,50	1	080090427
M30	1 3/16	140	4860	74,50	1	080090430

## 8048

tirantes de olhal rosca direita, negros



UNI 6058

ØxL mm	WFL kg	F mm	E mm	€	📦	🚚
M8x50	430	6	39	3,80	20	080480108
M8x65	430	6	54	4,10	20	080480109
M10x80	690	8	66	6,40	10	080480110
M10x100	690	8	86	6,40	10	080480110
M10x130	690	8	116	7,20	10	080480111
M12x70	1020	10	53	6,60	8	080480212
M12x95	1020	10	78	6,80	8	080480112
M12x125	1020	10	108	8,30	8	080480113
M14x110	1420	12	91	9,40	6	080480114
M16x100	1980	14	79	7,70	6	080480115
M16x130	1980	14	109	8,00	6	080480116
M18x150	2390	16	126	18,00	2	080480118
M20x160	3100	18	134	22,30	2	080480120
M22x180	3890	18	152	35,00	1	080480122
M24x200	4460	20	168	40,00	1	080480124
M24x220	4460	20	188	42,50	1	080480125
M27x220	5900	22	185	52,00	1	080480127

## 8302Z

parafuso com olhal de fixação  
rosca direita, zincado



### CARACTERÍSTICAS TÉCNICAS

- factor de segurança: 4
- CERTIFICADOS DISPONÍVEIS
- Especificações técnicas
- Relatório de ensaio UNI EN10204 tipo 2.2

Ø mm	E mm	F mm	WFL kg	€	📦	🚚
M5	48	8	115	0,61	200	083020005
M6	55	10	160	0,74	150	083020006
M8	60	12	300	1,00	100	083020008
M10	73	14	470	1,71	100	083020010
M12	90	17	690	3,30	50	083020012

### packs especiais



Ø mm	E mm	📦	€	📦	🚚
M5	48	100	69,00	1	083020705
M6	55	75	63,00	1	083020706
M8	60	50	56,50	1	083020708
M10	73	50	96,50	1	083020710
M12	90	25	93,50	1	083020712

## 8303Z

gancho de fixação rosca direita, zincado



### CARACTERÍSTICAS TÉCNICAS

- factor de segurança: 4
- CERTIFICADOS DISPONÍVEIS
- Especificações técnicas
- Relatório de ensaio UNI EN10204 tipo 2.2

Ø mm	C mm	E mm	WFL kg	€	📦	🚚
M5	6,0	48	25	0,72	120	083030005
M6	8,0	55	45	0,78	100	083030006
M8	10,0	60	95	1,28	75	083030008
M10	12,5	73	140	2,16	50	083030010
M12	16,0	90	220	3,60	20	083030012

### packs especiais



Ø mm	C mm	📦	€	📦	🚚
M5	6,0	60	48,50	1	083030705
M6	8,0	50	44,00	1	083030706
M8	10,0	30	43,00	1	083030708
M10	12,5	25	60,50	1	083030710
M12	16,0	10	40,50	1	083030712

## 8702N - 8702Z - 8702ZC

terminais em aço forjado

fechados  
preto



### CARACTERÍSTICAS TÉCNICAS

- código identificação
- TESTES LABORATORIAIS
- análises químicas
- ensaio de tensão
- CERTIFICADOS DISPONÍVEIS
- Especificações técnicas
- Relatório de teste UNI EN10204 tipo 2.2
- Certificado de inspeção UNI EN10204 tipo 3.1

M	ØB mm	ØA mm	ØD mm	€	📦	🚚
6	6,8	13	19	52,00	1	087020106
8	8,8	20	22	62,50	1	087020108
9	9,8	20	22	62,50	1	087020109
10	10,8	20	22	62,50	1	087020110
11	11,8	25	27	77,00	1	087020111
12	12,8	25	27	77,00	1	087020112
13	13,8	25	27	77,00	1	087020113
14	14,8	32	32	107,00	1	087020114
15	15,9	32	32	107,00	1	087020115
16	17,0	32	32	107,00	1	087020116
18	19,0	39	37	139,00	1	087020118
19	20,0	39	37	139,00	1	087020119
20	21,1	39	37	139,00	1	087020120
22	23,2	43	43	193,00	1	087020122
24	25,4	50	52	222,00	1	087020124
25	26,4	50	52	222,00	1	087020125
26	27,4	50	52	222,00	1	087020126

### 8702Z galvanização

M	ØB mm	ØA mm	ØD mm	€	📦	🚚
6	6,8	13	19	54,00	1	087020306
8	8,8	20	22	65,50	1	087020308
9	9,8	20	22	65,50	1	087020309
10	10,8	20	22	65,50	1	087020310
11	11,8	25	27	80,50	1	087020311
12	12,8	25	27	80,50	1	087020312
13	13,8	25	27	80,50	1	087020313
14	14,8	32	32	113,00	1	087020314
15	15,9	32	32	113,00	1	087020315
16	17,0	32	32	113,00	1	087020316
18	19,0	39	37	145,00	1	087020318
19	20,0	39	37	145,00	1	087020319
20	21,1	39	37	145,00	1	087020320
22	23,2	43	43	199,00	1	087020322
24	25,4	50	52	232,00	1	087020324
25	26,4	50	52	232,00	1	087020325
26	27,4	50	52	232,00	1	087020326

### 8702ZC galvanização a quente

M	ØB mm	ØA mm	ØD mm	€	📦	🚚
6	6,8	13	19	57,50	1	087020206
8	8,8	20	22	71,00	1	087020208
9	9,8	20	22	71,00	1	087020209
10	10,8	20	22	71,00	1	087020210
11	11,8	25	27	88,00	1	087020211
12	12,8	25	27	88,00	1	087020212
13	13,8	25	27	88,00	1	087020213
14	14,8	32	32	130,00	1	087020214
15	15,9	32	32	130,00	1	087020215
16	17,0	32	32	130,00	1	087020216
18	19,0	39	37	168,00	1	087020218
19	20,0	39	37	168,00	1	087020219
20	21,1	39	37	168,00	1	087020220
22	23,2	43	43	228,00	1	087020222
24	25,4	50	52	266,00	1	087020224
25	26,4	50	52	266,00	1	087020225
26	27,4	50	52	266,00	1	087020226



## 8709N - 8709Z - 8709ZC

terminais em aço forjado

abertos

preto



### CARACTERÍSTICAS TÉCNICAS

• código identificação

### TESTES LABORATORIAIS

- análises químicas
- ensaio de tensão

### CERTIFICADOS DISPONÍVEIS

- Especificações técnicas
- Relatório de teste UNI EN10204 tipo 2.2
- Certificado de inspeção UNI EN10204 tipo 3.1

M	Ø B mm	Ø A mm	Ø C mm	€		
6	6,8	13	17	71,00	1	087090106
8	8,8	20	21	92,00	1	087090108
9	9,8	20	21	92,00	1	087090109
10	10,8	20	21	92,00	1	087090110
11	11,8	25	25	115,00	1	087090111
12	12,8	25	25	115,00	1	087090112
13	13,8	25	25	115,00	1	087090113
14	14,8	32	30	160,00	1	087090114
15	15,9	32	30	160,00	1	087090115
16	17,0	32	30	160,00	1	087090116
18	19,0	39	35	208,00	1	087090118
19	20,0	39	35	208,00	1	087090119
20	21,1	39	35	208,00	1	087090120
22	23,2	43	41	265,00	1	087090122
24	25,4	50	51	272,00	1	087090124
25	26,4	50	51	272,00	1	087090125
26	27,4	50	51	272,00	1	087090126

### 8709Z galvanização

M	Ø B mm	Ø A mm	Ø C mm	€		
6	6,8	13	17	73,50	1	087090306
8	8,8	20	21	96,00	1	087090308
9	9,8	20	21	96,00	1	087090309
10	10,8	20	21	96,00	1	087090310
11	11,8	25	25	120,00	1	087090311
12	12,8	25	25	120,00	1	087090312
13	13,8	25	25	120,00	1	087090313
14	14,8	32	30	168,00	1	087090314
15	15,9	32	30	168,00	1	087090315
16	17,0	32	30	168,00	1	087090316
18	19,0	39	35	217,00	1	087090318
19	20,0	39	35	217,00	1	087090319
20	21,0	39	35	217,00	1	087090320
22	23,2	43	41	285,00	1	087090322
24	25,4	50	51	285,00	1	087090324
25	26,4	50	51	285,00	1	087090325
26	27,4	50	51	285,00	1	087090326

### 8709ZC galvanização a quente

M	Ø B mm	Ø A mm	Ø C mm	€		
6	6,8	13	17	76,00	1	087090206
8	8,8	20	21	101,00	1	087090208
9	9,8	20	21	101,00	1	087090209
10	10,8	20	21	101,00	1	087090210
11	11,8	25	25	131,00	1	087090211
12	12,8	25	25	131,00	1	087090212
13	13,8	25	25	131,00	1	087090213
14	14,8	32	30	190,00	1	087090214
15	15,9	32	30	190,00	1	087090215
16	17,0	32	30	190,00	1	087090216
18	19,0	39	35	241,00	1	087090218
19	20,0	39	35	241,00	1	087090219
20	21,1	39	35	241,00	1	087090220
22	23,2	43	41	308,00	1	087090222
24	25,4	50	51	338,00	1	087090224
25	26,4	50	51	338,00	1	087090225
26	27,4	50	51	338,00	1	087090226

## CERRA-CABOS

Os cerra-cabos profissionais para cabos de aço entrançados podem ser utilizados em sistemas de fixação e tensionamento. Ao contrário de muitos produtos disponíveis no mercado, os nossos cerra-cabos NÃO possuem corpos de ferro fundido.

Na verdade, para garantir um desempenho mecânico ideal em trabalhos pesados, as bases são forjadas a quente e são, em média, mais pesadas que artigos similares.

A galvanização eletrolítica de qualidade, isenta de crômio hexavalente, proporciona boa resistência à corrosão e melhora a aparência.

Durante as várias décadas de história da Empresa, todas estas características transformaram o artigo 8016 no ícone da marca Robur, permitindo que os cerra-cabos de "tipo italiano" se destacassem em todo o mundo.



## 8015

cerra cabos, tipo Americano, em aço, galvanização a quente

CE

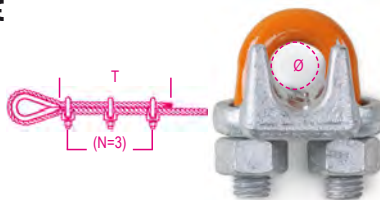

dimensioni EN 13411-5 tipo B

### Características técnicas:

• código de identificação

### TESTES LABORATORIAIS

- análise química
- ensaio de binário

### CERTIFICADOS DISPONÍVEIS

- Especificações técnicas
- Relatório de teste UNI EN10204 tipo 2.2
- Certificado do fabricante UNI EN13411-5
- Declaração de Conformidade CE

Ø mm	Ø "	NxT	Nm	€		
8	5/16	3x133	40,7	2,58	12	080150808
9-10	3/8	3x165	61	3,60	12	080150810
11-13	1/2	3x292	88	5,60	6	080150813
14-16	5/8	3x305	129	7,90	6	080150816
18-20	3/4	4x460	176	10,80	6	080150820
22	7/8	4x480	305	17,20	6	080150822
24-26	1	5x660	305	18,70	5	080150826
28-30	1-1/8	6x860	305	20,00	2	080150830

## 8016

cerra cabos em aço zincados

CE

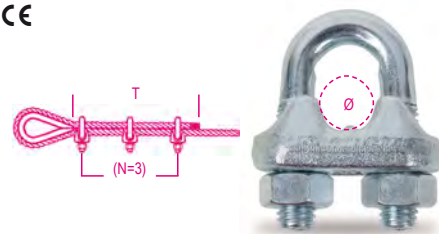

### CARACTERÍSTICAS TÉCNICAS

• análise química

• teste binário

### CERTIFICADOS DISPONÍVEIS

- Especificações técnicas
- Relatório de ensaio UNI EN10204 tipo 2.2
- Certificado de Conformidade CE

Ø mm	Ø "	NxT	Nm	€		
3	1/8	3x80	1,53	0,70	500	080160003
5	3/16	3x110	3,02	0,88	300	080160005
6	1/4	3x120	5,19	0,98	200	080160006
8	5/16	5x210	5,19	1,21	150	080160008
10	3/8	5x240	12,54	1,82	70	080160010
11	7/16	5x260	12,54	1,96	70	080160011
12-13	1/2	5x300	24,76	2,63	40	080160013
14	9/16	5x295	24,76	2,86	35	080160014
16	5/8	5x335	24,76	3,40	30	080160016
18	11/16	5x380	42,42	4,60	30	080160018
20	3/4	5x540	42,42	4,95	30	080160020
22	7/8	7x595	42,42	5,80	25	080160022
24-26	1"	7x700	67,56	8,00	15	080160026
28	1"1/16	8x840	67,56	10,00	5	080160028
30-32	1"1/8	8x990	67,56	10,00	5	080160030
34-36	1"1/4	8x1155	105,80	13,20	4	080160034
38-40	1"1/2	8x1320	105,80	17,80	2	080160040
45-50	2"	8x1500	206	27,50	1	080160050

### confeção especial



Ø mm	Ø "	NxT	€			
3	1/8	100	100	78,50	1	080160703
5	3/16	50	50	49,50	1	080160705
6	1/4	50	50	55,50	1	080160706
8	5/16	30	30	41,00	1	080160708
10	3/8	30	30	62,00	1	080160710
11	7/16	25	25	55,50	1	080160711
12-13	1/2	15	15	44,00	1	080160713

### Embalagens especiais com blister



Ø mm	€			
3	6	5,30	1	080169403
5	4	4,65	1	080169405
6	4	5,20	1	080169406
8	4	6,00	1	080169408
10	2	4,80	1	080169410
11	1	3,50	1	080169011
12-13	1	4,10	1	080169013
14	1	4,30	1	080169014
16	1	4,80	1	080169016
18	1	6,20	1	080169018
20	1	6,30	1	080169020
22	1	7,40	1	080169022
24-26	1	9,60	1	080169026



## 8016FR

cerra-cabos em ferro galvanizado

CE

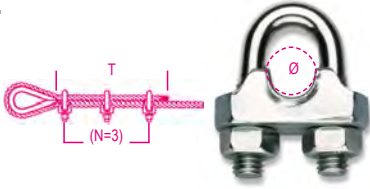

### TESTES LABORATORIAIS

- análise química
- CERTIFICADOS DISPONÍVEIS
- Especificações técnicas
- Relatório de ensaio UNI EN10204 tipo 2.2
- Certificado de Conformidade CE

Ø mm	Ø "	N x T	Nm	€		
3	1/8	3x80	1,25	0,64	500	080160253
5	3/16	3x110	2,46	0,76	300	080160255
6	1/4	3x120	4,24	0,93	200	080160256
8	5/16	5x210	4,24	1,08	150	080160258

## 8018E

cerra cabos zincado



### TESTES LABORATORIAIS

- análise química
- CERTIFICADOS DISPONÍVEIS
- Especificações técnicas
- Relatório de ensaio UNI EN10204 tipo 2.2

Ø mm	A mm	L mm	Nm	€		
4+6	M6	34	4,24	1,41	100	080180001

# Robur

# Robur

## 8016U2

cerra cabos galvanizado

CE

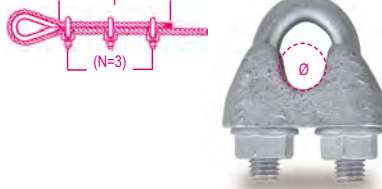

dimensioni EN 13411-5 tipo A

TESTES LABORATORIAIS • análise química • teste binário • CERTIFICADOS DISPONÍVEIS • Especificações técnicas • Relatório de ensaio UNI EN10204 tipo 2.2 • Certificado do fabricante UNI EN13411-5 • Certificado de Conformidade CE

Ø mm	Ø "	N x T	Nm	€		
5	3/16	3x156	2,0	0,38	300	080160855
6,5	1/4	3x192	3,5	0,51	150	080160856
8	5/16	4x320	6	1,05	70	080160858
10	3/8	4x320	9	1,09	60	080160860
12	1/2	4x384	20	2,07	25	080160862
14	9/16	4x448	33	3,25	15	080160864
16	5/8	4x512	49	4,80	10	080160866
19	3/4	4x512	68	5,60	10	080160869
22	7/8	5x680	107	8,00	10	080160872
26	1	5x760	147	14,40	5	080160876
30	1.1/8	6x984	212	18,50	5	080160880
34	1.1/4	6x1080	296	25,50	5	080160884
40	1.1/2	6x1176	363	31,00	5	080160890

Embalagens especiais com blister

Ø mm		€		
5	4	4,60	1	080169805
6	4	5,80	1	080169806
8	4	8,90	1	080169808
10	2	6,00	1	080169810
12	1	5,80	1	080169612
14	1	6,60	1	080169614
16	1	8,90	1	080169616
19	1	9,80	1	080169619
22	1	12,70	1	080169622
26	1	20,80	1	080169626

## 8016UGK

cerra-cabos,  
em ferro fundido maleável,  
corpo GALVANIZADO A QUENTE,  
parafusos e cavilhas GEOMET-GEOKOTE

CE



- elevada  
resistência à  
corrosão  
- código de  
identificação

dimensioni EN 13411-5 tipo A

### CARACTERÍSTICAS TÉCNICAS

- código identificação
- TESTES LABORATORIAIS
- análise química
- teste binário
- CERTIFICADOS DISPONÍVEIS
- Especificações técnicas
- Relatório de teste UNI EN10204 tipo 2.2
- Certificado Fabricante UNI EN13411-5
- Declaração de Conformidade CE

Ø mm	Ø "	N x T	Nm	€		
8	5/16	4x320	6	2,07	70	080160758
10	3/8	4x320	9	2,29	60	080160760
12	1/2	4x448	33	4,10	25	080160762
14	9/16	4x384	20	6,00	15	080160764
16	5/8	4x512	49	8,90	10	080160766
19	3/4	4x512	68	10,00	10	080160769
22	7/8	5x680	107	14,40	10	080160772
26	1	5x760	147	23,60	5	080160776
30	1,1/8	6x984	212	28,50	1	080160780
34	1,1/4	6x1080	296	40,50	1	080160784
40	1,1/2	6x1176	363	50,50	1	080160790

## 8018T

cerra cabos zincado



RUM-MU-21:1980

### TESTES LABORATORIAIS

- análise química
- CERTIFICADOS DISPONÍVEIS
- Especificações técnicas
- Relatório de ensaio UNI EN10204 tipo 2.2

Ø mm	A mm	L mm	Nm	€		
8+10	M8	42	10,20	1,44	200	080180003

# Robur

## 8020A

guarda-cabos, modelo italiano, galvanizados

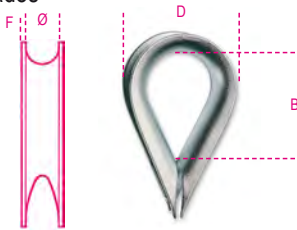

### CERTIFICADOS DISPONÍVEIS

- Especificações técnicas
- Relatório de teste UNI EN10204 tipo 2.2

Ø mm	F mm	B mm	D mm	€		
2-3	1,0	20	18	0,26	150	080200503
4	1,2	23	19	0,27	150	080200504
5	1,2	24	23	0,32	100	080200505
6	1,2	27	28	0,33	100	080200506
8	1,4	33	32	0,51	50	080200508
10	1,8	41	38	0,75	30	080200510
12	2,2	44	45	0,99	30	080200512
14	2,2	52	49	1,28	50	080200514
16	3,0	58	58	1,79	50	080200516
18	3,7	64	68	2,52	50	080200518
20	3,7	73	74	3,25	35	080200520
22	3,7	83	79	3,65	30	080200522
24	3,7	93	88	4,80	20	080200525

confeção especial



Ø mm	S mm		€	
2-3	0,8	150	39,50	1 080200703
4	1,0	150	41,00	1 080200704
5	1,0	100	31,50	1 080200705
6	1,0	100	32,50	1 080200706
8	1,2	50	25,50	1 080200708
10	1,5	30	22,60	1 080200710

# Robur

## 8021A

guarda cabos

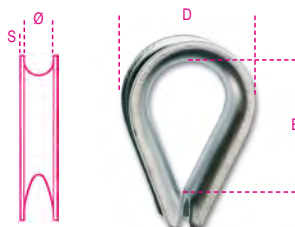

### CERTIFICADOS DISPONÍVEIS

- Especificações técnicas
- Relatório de ensaio UNI EN10204 tipo 2.2

Ø mm	S mm	B mm	D mm	€		
2-3	0,6	15	16	0,43	150	080210103
5	1,7	29	28	0,61	120	080210105
6	1,8	33	30	0,68	100	080210106
8	2,5	36	37	0,92	100	080210108
10	2,5	42	43	1,11	80	080210110
12	2,5	48	50	1,44	100	080210112
14	2,7	58	57	1,93	70	080210114
16	3	61	62	2,35	50	080210116
18	3,5	71	71	3,05	70	080210118
20	4	79	79	4,60	30	080210120
22	4	87	84	5,30	25	080210122
24	4	93	92	6,30	25	080210124
26	4	103	103	7,70	20	080210126
28	5	107	116	18,00	1	080210128
30	5	118	121	18,00	1	080210130
32	5,5	138	135	21,60	1	080210132
35	6	140	147	30,00	1	080210135
40	6,0	174	170	42,50	1	080210140

## MANILHAS

Ao contrário de produtos similares, as manilhas de alta resistência da Robur são feitas inteiramente de liga de aço cromo molibdênio endurecido e temperado e concebidas para exceder 20.000 ciclos de carga total em testes de laboratório. Destacam-se, portanto, na sua categoria, como a melhor opção para trabalhos pesados, com fator de segurança superior aos padrões de referência (6:1 em vez de 5:1) e excelente resiliência em baixas temperaturas.

As manilhas de aço macio da Robur são sinónimo de fiabilidade e eficácia, baseadas em matéria-prima de alta qualidade, excelente acabamento mecânico e tratamento térmico (normalizado), que permitem alcançar uma elevada carga de trabalho e fator de segurança em comparação com produtos equivalentes disponíveis no mercado.

A marcação clara e indelével em cada peça permite identificar a origem da manilha, por ex. no caso de inspeções por empresas de auditoria ou órgãos competentes.



## 8026R

manilhas direitas, aço de elevada resistência, pino de anel, zincadas a quente

CE

EN 13889



### CARACTERÍSTICAS TÉCNICAS

- factor de segurança mínimo: 6 • tratamento a quente: endurecimento e reforço • código de deteção no pino e na estrutura
- TESTES LABORATORIAIS
- análise química • análise metalográfica • teste elasticidade
- teste de fadiga (min. 20.000 ciclos) • teste prova de carga (2 x WLL)
- CERTIFICADOS DISPONÍVEIS
- Especificações de Produto • Relatório de Teste UNI EN10204 tipo 2.2
- Certificado de Inspeção UNI EN10204 tipo 3.1 • Declaração de Conformidade CE

ØD mm	ØA mm	H mm	WLL kg	€		
11	10	17	1000	7,00	5	080260210
16	13	21	2000	13,00	5	080260212
19	16	27	3250	22,00	3	080260216
22	19	32	4750	31,50	2	080260219
25	22	37	6500	48,50	2	080260222

Embalagens especiais com blister



ØD mm		€	
16	1	14,20	1 080269212
19	1	23,60	1 080269216

## 8029R

manilhas tipo lira, pino de aperto em aço de elevada resistência, zincadas a quente

CE

EN 13889

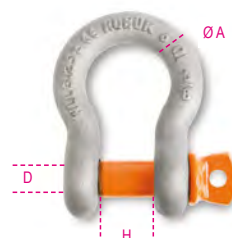

### CARACTERÍSTICAS TÉCNICAS

- factor de segurança mín.: 6
- tratamento a quente: reforçado e temperado
- código de localização no pino e corpo
- teste de fadiga (min. 20.000 ciclos)
- teste prova de carga (2 x WLL)
- CERTIFICADOS DISPONÍVEIS
- Especificações de Produto
- Relatório de Teste UNI EN10204 tipo 2.2
- Certificado de Inspeção UNI EN10204 tipo 3.1
- Declaração de Conformidade CE

ØD mm	ØA mm	H mm	WLL kg	€		
8	6	13	500	4,25	20	080290106
10	8	13,5	750	5,20	15	080290108
11	10	17	1000	7,40	15	080290110
13	11	18,5	1500	9,80	10	080290111
16	13	20,5	2000	10,00	8	080290112
19	16	27	3250	17,20	8	080290116
22	19	32	4750	25,00	4	080290120
25	22	37	6500	37,50	4	080290122
28	26	43,5	8500	52,00	1	080290124

ØD mm	ØA mm	H mm	WLL kg	€	📦	📄
32	29	48	9500	96,50	1	080290128
35	32	53	12000	130,00	1	080290132
38	35	59	13500	170,00	1	080290135
42	38	62	17000	222,00	1	080290138
50	45	75	25000	380,00	1	080290145
57	50	83	35000	665,00	1	080290150
65	57	95	42500	1.150,00	1	080290157
70	65	105	55000	1.310,00	1	080290165

### Embalagens especiais com blister



ØD mm	📦	€	📄	📄
8	1	5,80	1	080299106
10	1	6,60	1	080299108
11	1	8,90	1	080299110
13	1	11,30	1	080299111
16	1	11,50	1	080299112
19	1	19,30	1	080299116

### packs especiais



ØD mm	ØA mm	📦	€	📄	📄
8	6	10	48,00	1	080290706
10	8	10	58,50	1	080290708
11	10	10	82,50	1	080290710
13	11	5	54,50	1	080290711
16	13	4	44,50	1	080290712
19	16	4	77,00	1	080290716
22	19	2	57,00	1	080290720
25	22	2	84,50	1	080290722

### 8031R

manilhas tipo lira, parafuso de segurança em aço de elevada resistência, zincadas a quente

CE



EN 13889

#### CARACTERÍSTICAS TÉCNICAS

- factor de segurança mín.: 6
- tratamento a quente: reforçado e temperado
- código de localização no pino e corpo
- teste de fadiga (min. 20.000 ciclos)
- teste prova de carga (2 x WLL)

#### CERTIFICADOS DISPONÍVEIS

- Especificações de Produto
- Relatório de Teste UNI EN10204 tipo 2.2
- Certificado de Inspeção UNI EN10204 tipo 3.1
- Declaração de Conformidade CE

ØD mm	ØA mm	H mm	WLL kg	€	📦	📄
11	10	17	1000	7,90	5	080310110
13	11	18	1500	12,10	5	080310111
16	13	21	2000	12,40	5	080310112
19	16	27	3250	21,20	3	080310116
22	19	32	4750	30,00	2	080310120

ØA mm	ØD mm	H mm	WLL kg	€	📦	📄
22	25	37	6500	41,50	2	080310122
26	28	43	8500	62,00	1	080310124
29	32	48	9500	106,00	1	080310128
32	35	53	12000	137,00	1	080310132
35	38	59	13500	193,00	1	080310135
38	42	62	17000	235,00	1	080310138
45	50	75	25000	411,00	1	080310145
50	57	83	35000	725,00	1	080310150
65	70	105	55000	1.480,00	1	080310165
75	83	127	85000	2.240,00	1	080310183

### Embalagens especiais com blister



ØD mm	📦	€	📄	📄
16	1	15,30	1	080319112
19	1	26,00	1	080319116

### 8032

manilhas tipo lira, aço de elevada resistência, pino quadrado, zincadas a quente

CE

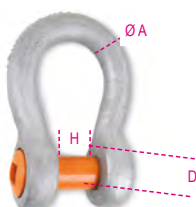

#### CARACTERÍSTICAS TÉCNICAS

- factor segurança mínimo: 6
- tratamento a quente: endurecimento e reforço
- código de detecção no pino e corpo

#### TESTES LABORATORIAIS

- análise química
- análise metalográfica
- teste de elasticidade
- teste de fadiga (min. 20.000 ciclos)
- teste prova de carga (2 x WLL)

#### CERTIFICADOS DISPONÍVEIS

- Especificações Técnicas
- Relatório de Teste UNI EN10204 tipo 2.2
- Certificado de Inspeção UNI EN10204 tipo 3.1
- Declaração de Conformidade CE

ØD mm	ØA mm	H mm	WLL kg	€	📦	📄
11	10	17	1000	9,40	5	080320010
16	13	21	2000	11,80	5	080320012
19	16	27	3250	21,50	3	080320016
22	19	32	4750	37,00	2	080320020
25	22	37	6500	54,00	2	080320022

### Embalagens especiais com blister



ØD mm	📦	€	📄	📄
16	1	14,20	1	080329012
19	1	23,60	1	080329016



### 8025

manilhas direitas, largas, forjadas a quente em aço de carbono, zincadas

CE



#### CARACTERÍSTICAS TÉCNICAS

- factor de segurança: 5
- tratamento térmico: normalizador
- código de identificação

#### TESTES LABORATORIAIS

- análise química
  - análise metalográfica
  - ensaio de tracção
- CERTIFICADOS DISPONÍVEIS**
- Especificações técnicas
  - Relatório de ensaio UNI EN10204 tipo 2.2
  - Certificado de inspeção UNI EN10204 tipo 3.1
  - Declaração de Conformidade CE

Ø mm	≈	B x C mm	WLL kg	€	📦	📄
5	3/16	21x10	70	1,65	250	080250005
6	1/4	25x12	100	2,22	250	080250006
8	5/16	33x16	250	3,70	150	080250008
10	3/8	42x20	400	4,10	180	080250010
11	7/16	46x22	500	5,10	130	080250011
12	1/2	50x24	600	5,40	100	080250012
14	9/16	57x28	800	7,10	70	080250014
16	5/8	61x32	1000	9,20	10	080250016
18	11/16	65x36	1300	13,30	10	080250018
20	3/4	70x40	1600	15,60	10	080250020
22	7/8	74x44	2000	21,60	10	080250022
25	1"	80x48	2800	29,00	2	080250025

### confecção especial



Ø mm	📦	€	📄	📄	
5	3/16	25	46,50	1	080250705
6	1/4	25	63,00	1	080250706
8	5/16	25	105,00	1	080250708
10	3/8	15	69,00	1	080250710
11	7/16	12	68,00	1	080250711
12	1/2	12	73,50	1	080250712
14	9/16	10	79,50	1	080250714

### Embalagens especiais com blister



Ø mm	📦	€	📄	📄
5	4	8,30	1	080259205
6	4	10,60	1	080259206
8	2	8,90	1	080259208
10	2	9,50	1	080259210
11	1	6,30	1	080259011
12	1	6,80	1	080259012
14	1	8,30	1	080259014
16	1	10,50	1	080259016
18	1	15,60	1	080259018
20	1	17,60	1	080259020
22	1	22,90	1	080259022
25	1	30,00	1	080259025



## 8026A

manilhas direitas,  
forjadas a quente em aço carbono,  
UNI 1947 tipo A, zincadas

CE

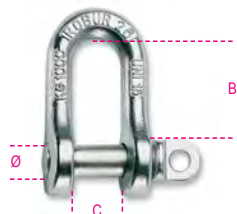

### CARACTERÍSTICAS TÉCNICAS

- factor de segurança: 5
- tratamento térmico: normalizador
- código de identificação

### TESTES LABORATORIAIS

- análise química
- análise metalográfica
- ensaio de tracção

### CERTIFICADOS DISPONÍVEIS

- Especificações técnicas
- Relatório de ensaio UNI EN10204 tipo 2.2
- Certificado de inspecção UNI EN10204 tipo 3.1
- Declaração de Conformidade CE

Ø mm	≈ "	B x C mm	WLL kg	€	📦	🚚
12	1/2	42x20	630	5,20	35	080260012
14	9/16	46x22	800	6,50	30	080260014
16	5/8	50x24	1000	8,30	20	080260016
18	11/16	54x26	1300	11,70	15	080260018
20	3/4	58x28	1600	14,80	10	080260020
22	7/8	69x32	2000	19,30	10	080260022
25	1"	79x36	2500	27,50	5	080260025
28	1.1/8	90x40	3150	37,50	2	080260028
32	1.1/4	100x45	4000	52,00	1	080260032
36	1.3/8	110x50	5000	74,50	1	080260036
40	1.9/16	120x55	6300	103,00	1	080260040
42	1.5/8	131x60	8000	141,00	1	080260042
45	1.3/4	143x65	10000	192,00	1	080260045
50	2"	155x70	12500	238,00	1	080260050

### Embalagens especiais com blister



Ø mm	📦	€	📦	🚚
12	1	6,70	1	080269012
14	1	8,00	1	080269014
16	1	9,40	1	080269016
18	1	14,20	1	080269018
20	1	16,90	1	080269020
22	1	21,60	1	080269022
25	1	30,00	1	080269025



## 8028

manilhas tipo lira,  
forjadas a quente em aço carbono,  
zincadas

CE

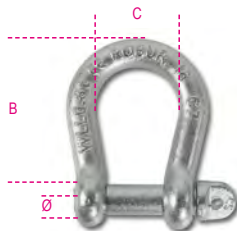

### CARACTERÍSTICAS TÉCNICAS

- factor de segurança: 5
- tratamento térmico: normalizador
- código de identificação

### TESTES LABORATORIAIS

- análise química
- análise metalográfica
- ensaio de tracção

### CERTIFICADOS DISPONÍVEIS

- Especificações técnicas
- Relatório de ensaio UNI EN10204 tipo 2.2
- Certificado de inspecção UNI EN10204 tipo 3.1
- Declaração de Conformidade CE

Ø mm	≈ "	B x C mm	WLL kg	€	📦	🚚
5	3/16	20x16	80	1,42	100	080280105
6	1/4	24x20	100	2,11	70	080280106
8	5/16	32x24	200	3,65	35	080280108
10	3/8	40x33	300	4,20	25	080280110
12	1/2	48x39	500	6,70	15	080280112
14	9/16	56x46	600	9,50	7	080280114
16	5/8	64x46	800	14,30	10	080280116
18	11/16	71x59	950	17,60	5	080280118
20	3/4	80x65	1100	25,00	5	080280120
22	7/8	88x72	1500	31,50	5	080280122
25	1"	100x81	2000	48,50	2	080280125
28	1.1/8	112x91	2600	75,50	1	080280128
32	1.1/4	128x104	3200	104,00	1	080280132
38	1.1/2	152x124	4500	205,00	1	080280138

### Embalagens especiais com blister



Ø mm	📦	€	📦	🚚
5	4	7,10	1	080289305
6	4	10,20	1	080289306
8	2	9,20	1	080289308
10	2	9,90	1	080289310
12	1	8,20	1	080289112
14	1	10,90	1	080289114
16	1	15,50	1	080289116
18	1	19,70	1	080289118
20	1	27,00	1	080289120
22	1	35,00	1	080289122

## 8049 WLL (t)

	A°	M8	M10	M12	M16	M20	M24	M30
	0°	0,3	0,6	1	1,6	2,5	4	6,3
	0°	0,6	1,2	2	3,2	5	8	12,6
	90°	0,3	0,6	1	1,6	2,5	4	6,3
	90°	0,6	1,2	2	3,2	5	8	12,6
	0° 45° 60°	0,4	0,8	1,4	2,2	3,5	5,6	8,8
	46° 60°	0,3	0,6	1	1,6	2,5	4	6,3
	0° 45° 60°	0,6	1,3	2,1	3,4	5,3	8,4	13,2
	46° 60°	0,3	0,6	1	1,6	2,3	4	6,3

## 8049

argolas de elevação ajustáveis,  
articulação dupla,  
liga de aço de elevada resistência

CE

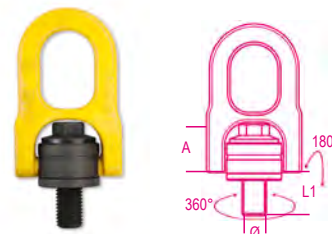

### CARACTERÍSTICAS TÉCNICAS

- factor de segurança: 5
- tratamento térmico: endurecido e temperado
- código de identificação

### TESTES LABORATORIAIS

- análise química
- análise metalográfica
- ensaio de tracção

### CERTIFICADOS DISPONÍVEIS

- teste de fadiga (20,000 ciclos)
- Especificações técnicas
- Relatório de ensaio UNI EN10204 tipo 2.2
- Certificado de inspecção UNI EN10204 tipo 3.1
- Declaração de Conformidade CE

Ø mm	A mm	L1 mm	WLL 90° kg	€	📦	🚚
M8	31,5	14	300	142,00	1	080490008
M10	31,5	17	600	148,00	1	080490010
M12	31,5	21	1000	152,00	1	080490012
M16	45	27	1600	175,00	1	080490016
M20	45	30	2500	179,00	1	080490020
M24	60,5	36	4000	307,00	1	080490024
M30	60,5	45	6300	320,00	1	080490030

## 8049A WLL (kg)

	B°	M6	M8	M10	M12	M16	M20	M24	M30	M36
	0°	400	600	900	1000	2000	4000	6300	10600	11800
	0°	800	1200	1800	2000	4000	8000	12600	21200	23600
	90°	200	300	450	500	1120	2000	3150	5300	8000
	90°	400	600	900	1000	2000	4000	6300	10600	16000
	0°	250	400	600	700	1400	2800	4250	7100	10700
	45°	200	300	450	500	1120	2000	3150	5300	8000
	0°	400	600	900	1000	2100	4200	6300	11200	16000
	45°	250	400	600	750	1500	3000	4750	8000	10700

## 8049A

argolas de elevação com articulação dupla, ajustáveis em carga, com anel soldado, liga de aço de elevada resistência

CE



### CARACTERÍSTICAS TÉCNICAS

- fator de segurança: 4
  - tratamento térmico: endurecido
  - código de identificação
- ### TESTES LABORATORIAIS
- análise química
  - análise metalográfica
  - ensaio de tensão
  - teste de fadiga (20.000 ciclos)
  - teste de carga (100% da produção)

### CERTIFICADOS DISPONÍVEIS

- Especificações técnicas
- Relatório de teste UNI EN10204 tipo 2.2
- Certificado de inspeção UNI EN10204 tipo 3.1
- Declaração de Conformidade CE

Ø	E	A	WLL	€		
mm	mm	mm	kg			
M6	13	30	200	47,00	1	080490106
M8	13	30	300	48,00	1	080490108
M10	19	30	450	50,50	1	080490110
M12	19	30	500	53,50	1	080490112
M14	19	30	1120	54,50	1	080490114
M16	20	30	1120	57,00	1	080490116
M18	30	40	2000	71,00	1	080490118
M20	30	40	2000	82,00	1	080490120
M24	30	40	3150	120,00	1	080490124
M30	35	50	5300	208,00	1	080490130
M36	54	50	8000	218,00	1	080490136

## 8049V

argolas de elevação com suporte, liga de aço de elevada resistência  
argola giratória 360° e suporte giratório

CE



### Características técnicas:

- fator de segurança: 4
- tratamento térmico: endurecido e temperado
- código de identificação

### TESTES LABORATORIAIS

- análise química
- análise metalográfica
- ensaio de tensão
- teste de fadiga (20.000 ciclos)
- teste de carga (100% da produção)

### CERTIFICADOS DISPONÍVEIS

- Especificações técnicas
- Relatório de teste UNI EN10204 tipo 2.2
- Certificado de inspeção UNI EN10204 tipo 3.1
- Declaração de Conformidade CE

Ø	E	B	WLL	€		
mm	mm	mm	kg			
M10	13,5	37	630	78,50	1	080490310
M12	18	37,5	1000	96,00	1	080490312
M16	24	37,5	1500	103,00	1	080490316
M20	35,5	54	2500	149,00	1	080490320
M24	35,5	54	4000	154,00	1	080490324

## 8068S

suporte para elevação de carga, base simples, com molas de posicionamento, em liga de aço de elevada resistência

- Dimensões compactas para operações de elevação
- Testado para suportar 20.000 ciclos de trabalho em carga máxima
- Carga de teste aplicada a 100% das peças antes da venda
- Fator de segurança: 4, em todas as direções

CE



### Características técnicas

- fator de segurança: 4
- tratamento térmico: endurecido
- código de identificação

### TESTES LABORATORIAIS

- análise química
- análise metalográfica
- ensaio de tensão
- teste de fadiga (20.000 ciclos)
- teste de carga (100% da produção)

### CERTIFICADOS DISPONÍVEIS

- Especificações técnicas
- Relatório de teste UNI EN10204 tipo 2.2
- Certificado de inspeção UNI EN10204 tipo 3.1
- Declaração de Conformidade CE

WLL	B	M	A	€		
Kg	mm	mm	mm			
1500	78	37	41	11,60	1	080680115
2500	88	40	42	15,20	1	080680125
4000	94	42	45	21,70	1	080680140
6700	118	51	55	40,50	1	080680167

### Atenção:

- O elemento de acoplamento deve proporcionar resistência mecânica adequada e ser apropriado para soldadura.
- Os trabalhos de soldadura devem ser realizados por pessoal qualificado.

## 8041

argolas de elevação, liga de aço de elevada resistência

CE



### Características técnicas

- fator de segurança: 4
- tratamento térmico: endurecido e temperado
- código de identificação

### TESTES LABORATORIAIS

- análise química
- ensaio de tração
- teste de fadiga (20.000 ciclos)
- teste prova de carga (100% do lote)

### CERTIFICADOS DISPONÍVEIS

- Especificações técnicas
- Relatório de ensaio UNI EN10204 tipo 2.2
- Certificado de inspeção UNI EN10204 tipo 3.1
- Declaração de Conformidade CE

Ø	WLL	E	€		
mm	mm	mm			
M6	1	11	400	3,80	10 080410206
* M8	1,25	13	800	3,80	10 080410208
* M10	1,5	17	1000	5,90	6 080410210
* M12	1,75	20,5	1600	8,90	4 080410212
M14	2	20,5	3000	14,80	2 080410214
M16	2,5	27	4000	22,30	2 080410217
M18	2,5	27	5000	22,30	2 080410218
M20	3,0	30	6000	41,50	2 080410221
M22	2,5	30	7000	41,50	2 080410222
M24	3	36	8000	50,50	2 080410225
M27	3	41	10000	76,50	1 080410227
* M30	3,5	45	12000	76,50	1 080410230

(\* Especificações dimensionais DIN 580:2010

WLL aumentado conforme as especificações técnicas dos produtos Robur

Embalagens especiais com blister



Ø	€		
mm			
* M8	1	6,20	1 080419208
* M10	1	8,60	1 080419210
* M12	1	11,80	1 080419212





## 8043

argolas de elevação,  
liga de aço de elevada resistência

CE

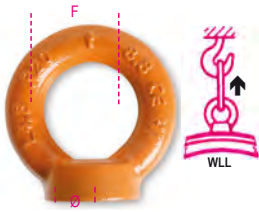

### CARACTERÍSTICAS TÉCNICAS

- fator de segurança: 4
- tratamento térmico: endurecido e temperado

• código de identificação

### TESTES LABORATORIAIS

- análise química
- ensaio de tração
- teste de fadiga (20,000 ciclos)
- teste prova de carga (100% do lote)

### CERTIFICADOS DISPONÍVEIS

- Especificações técnicas
- Relatório de ensaio UNI EN10204 tipo 2.2
- Certificado de inspeção UNI EN10204 tipo 3.1
- Declaração de Conformidade CE

Ø mm	mm	F mm	WLL kg	€		
M6	1	20	400	3,70	10	080430206
* M8	1,25	20	800	3,70	10	080430208
* M10	1,50	25	1000	5,80	6	080430210
* M12	1,75	30	1600	8,80	4	080430212
M14	2	35	3000	14,40	2	080430214
M16	2	40	4000	20,90	2	080430217
M18	2,5	40	5000	20,90	2	080430218
M20	2,5	50	6000	40,50	2	080430221
M22	2,5	50	7000	40,50	2	080430222
M24	3	55	8000	47,00	2	080430225
M27	3	60	10000	73,50	1	080430227
* M30	3,5	60	12000	73,50	1	080430230

(\* Especificações dimensionais DIN 582:2010

WLL aumentado conforme as especificações técnicas dos produtos Robur

Embalagens especiais com blister



Ø mm	mm	€		
* M8	1	5,80	1	080439208
* M10	1	8,30	1	080439210
* M12	1	11,30	1	080439212

## ARGOLAS E OLHAIS DE ELEVÇÃO

As argolas e olhas de elevação da Robur são fabricados em aço carbono macio, com adição de teor mínimo de alumínio, e devem cumprir rigorosos parâmetros relativos à granulometria do material, conforme a DIN580-582.



O excelente acabamento mecânico também contribui para fazer a diferença: a ranhura em relevo dos colares na base das argolas/olhas de elevação resulta numa melhor aderência e contato total com a superfície do corpo a ser elevado.

Com base nestas características, os nossos parafusos/olhas de elevação são ideais para tarefas de elevação complexas e utilização intensiva, por ex. em ambientes com funcionamento em ciclo contínuo ou intervalos de temperatura de -20 °C ÷ +200 °C

## 8040EZ

argolas de elevação macho,  
galvanizadas

CE



DIN 580:2018-04(\*\*)

### CARACTERÍSTICAS TÉCNICAS

- fator de segurança: 6
- tratamento térmico: normalizador

• código de identificação

### TESTES LABORATORIAIS

- análise química
- análise metalográfica
- ensaio de tração

### CERTIFICADOS DISPONÍVEIS

- Especificações técnicas
- Relatório de ensaio UNI EN10204 tipo 2.2
- Certificado de inspeção UNI EN10204 tipo 3.1
- Declaração de Conformidade CE

Ø mm	mm	E mm	WLL kg	€		
* M6	1	11	90	2,07	60	080400406
M8	1,25	13	140	2,07	60	080400408
M10	1,5	17	230	2,78	40	080400410
M12	1,75	20,5	340	3,70	20	080400412
* M14	2	20,5	480	4,90	20	080400414
M16	2	27	700	6,20	10	080400416
* M18	2,5	27	930	7,50	10	080400418
M20	2,5	30	1200	9,50	10	080400420
* M22	2,5	30	1450	12,30	10	080400422
M24	3	36	1800	18,00	5	080400424
* M27	3	41	2400	22,30	5	080400427
M30	3,5	45	3200	37,00	2	080400430
* M33	3,5	54	3900	52,00	2	080400433
* M33F	2	54	3900	52,00	2	080400434
M36	4	54	4600	53,50	2	080400436
* M36F	3	54	4600	53,50	2	080400437
M42	4,5	63	6300	98,50	1	080400442
* M42F	3	63	6300	98,50	1	080400443
M48	5	68	8600	158,00	1	080400448
* M48F	3	68	8600	158,00	1	080400449
M56	5,5	78	11500	258,00	1	080400456
* M56F	4	78	11500	258,00	1	080400457
M64	6	90	16000	379,00	1	080400464
* M64F	4	90	16000	379,00	1	080400465

\*Tamanhos dimensionados de acordo com a Ficha Técnica Robur

argola de elevação macho, galvanizada



Ø mm	mm	mm	€		
M6	1	20	46,50	1	080400906
M8	1,25	20	46,50	1	080400908
M10	1,5	20	63,00	1	080400910
M12	1,75	15	63,00	1	080400912

Embalagens especiais com blister



Ø mm	mm	€		
M6	4	10,40	1	080409606
M8	4	10,40	1	080409608
M10	2	7,70	1	080409610
M12	1	5,30	1	080409412
* M14	1	6,30	1	080409414
M16	1	7,70	1	080409416
* M18	1	9,10	1	080409418
M20	1	10,90	1	080409420

Ø mm	mm	€		
* M22	1	14,40	1	080409422
M24	1	19,50	1	080409424
* M27	1	24,40	1	080409427
M30	1	38,00	1	080409430

## 8040EN

argolas de elevação macho,  
negras

CE



DIN 580:2018-04(\*\*)

### CARACTERÍSTICAS TÉCNICAS

- fator de segurança: 6
- tratamento térmico: normalizador

• código de identificação

### TESTES LABORATORIAIS

- análise química
- análise metalográfica
- ensaio de tração

### CERTIFICADOS DISPONÍVEIS

- Especificações técnicas
- Relatório de ensaio UNI EN10204 tipo 2.2
- Certificado de inspeção UNI EN10204 tipo 3.1
- Declaração de Conformidade CE

Ø mm	mm	E mm	WLL kg	€		
* M6	1	11	90	1,99	60	080400306
M8	1,25	13	140	1,99	60	080400308
M10	1,5	17	230	2,71	40	080400310
M12	1,75	20,5	340	3,70	20	080400312
* M14	2	20,5	480	4,65	20	080400314
M16	2	27	700	5,80	10	080400316
* M18	2,5	27	930	7,20	10	080400318
M20	2,5	30	1200	8,90	10	080400320
* M22	2,5	30	1450	11,70	10	080400322
M24	3	36	1800	16,50	5	080400324
* M27	3	41	2400	20,80	5	080400327
M30	3,5	45	3200	35,00	2	080400330
* M33	3,5	54	3900	48,50	2	080400333
* M33F	2	54	3900	48,50	2	080400334
M36	4	54	4600	51,50	2	080400336
* M36F	3	54	4600	51,50	2	080400337
M42	4,5	63	6300	94,50	1	080400342
* M42F	3	63	6300	94,50	1	080400343
M48	5	68	8600	155,00	1	080400348
* M48F	3	68	8600	155,00	1	080400349
M56	5,5	78	11500	246,00	1	080400356
* M56F	4	78	11500	246,00	1	080400357
M64	6	90	16000	358,00	1	080400364
* M64F	4	90	16000	358,00	1	080400365

\*Tamanhos dimensionados de acordo com a Ficha Técnica Robur

Embalagens especiais com blister



Ø mm	mm	€		
M6	4	9,80	1	080409506
M8	4	9,80	1	080409508
M10	2	7,10	1	080409510
M12	1	5,10	1	080409312
* M14	1	6,00	1	080409314
M16	1	7,10	1	080409316
* M18	1	8,50	1	080409318
M20	1	9,90	1	080409320
* M22	1	13,50	1	080409322
M24	1	18,00	1	080409324
* M27	1	22,30	1	080409327
M30	1	36,00	1	080409330



## 8042EZ

argolas de elevação macho, galvanizadas

CE

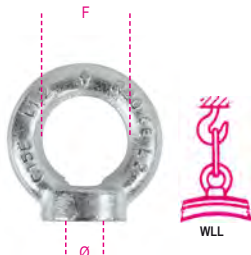

DIN582:2018-04(\*\*)

### CARACTERÍSTICAS TÉCNICAS

- fator de segurança: 6
- tratamento térmico: normalizador
- código de identificação

### TESTES LABORATORIAIS

- análise química
- análise metalográfica
- ensaio de tração

### CERTIFICADOS DISPONÍVEIS

- Especificações técnicas
- Relatório de ensaio UNI EN10204 tipo 2.2
- Certificado de inspeção UNI EN10204 tipo 3.1
- Declaração de Conformidade CE

Ø mm	W mm	F mm	WLL kg	€	📦	🚚
* M6	1	14	90	2,07	60	080420406
M8	1,25	20	140	2,07	60	080420408
M10	1,5	25	230	2,78	40	080420410
M12	1,75	30	340	3,80	30	080420412
* M14	2	30	480	4,90	30	080420414
M16	2	35	700	6,20	20	080420416
* M18	2,5	35	930	7,50	20	080420418
M20	2,5	40	1200	9,40	10	080420420
* M22	2,5	40	1450	12,10	10	080420422
M24	3	50	1800	18,00	5	080420424
* M27	3	55	2400	21,60	5	080420427
M30	3,5	60	3200	35,00	3	080420430
M36	4	70	4600	53,00	2	080420436
* M36F	3	70	4600	53,00	2	080420437
M42	4,5	80	6300	96,00	1	080420442
* M42F	3	80	6300	96,00	1	080420443
M48	5	90	8600	156,00	1	080420448
* M48F	3	90	8600	156,00	1	080420449

\*Tamanhos dimensionados de acordo com a Ficha Técnica Robur

### packs especiais



Ø mm	W mm	F mm	WLL kg	€	📦	🚚
M6	1	20		44,50	1	080420906
M8	1,25	20		44,50	1	080420908
M10	1,5	20		61,50	1	080420910
M12	1,75	15		63,00	1	080420912

### Embalagens especiais com blister



Ø mm	W mm	€	📦	🚚
M6	4	10,00	1	080429606
M8	4	10,00	1	080429608
M10	2	7,20	1	080429610
M12	1	5,30	1	080429612
* M14	1	6,00	1	080429414
M16	1	7,50	1	080429416
* M18	1	8,60	1	080429418
M20	1	10,60	1	080429420
* M22	1	13,50	1	080429422
M24	1	20,80	1	080429424
* M27	1	22,90	1	080429427
M30	1	35,50	1	080429430



## 8042EN

argolas de elevação macho, negras

CE



DIN582:2018-04(\*\*)

### CARACTERÍSTICAS TÉCNICAS

- fator de segurança: 6
- tratamento térmico: normalizador
- código de identificação

### TESTES LABORATORIAIS

- análise química
- análise metalográfica
- ensaio de tração

### CERTIFICADOS DISPONÍVEIS

- Especificações técnicas
- Relatório de ensaio UNI EN10204 tipo 2.2
- Certificado de inspeção UNI EN10204 tipo 3.1
- Declaração de Conformidade CE

Ø mm	W mm	F mm	WLL kg	€	📦	🚚
* M6	1	14	90	1,99	60	080420306
M8	1,25	20	140	1,99	60	080420308
M10	1,5	25	230	2,65	40	080420310
M12	1,75	30	340	3,70	30	080420312
* M14	2	30	480	4,75	30	080420314
M16	2	35	700	5,60	20	080420316
* M18	2,5	35	930	7,10	20	080420318
M20	2,5	40	1200	8,60	10	080420320
* M22	2,5	40	1450	11,50	10	080420322
M24	3	50	1800	16,50	5	080420324
* M27	3	55	2400	20,00	5	080420327
M30	3,5	60	3200	31,50	3	080420330
M36	4	70	4600	48,50	2	080420336
* M36F	3	70	4600	48,50	2	080420337
M42	4,5	80	6300	90,00	1	080420342
* M42F	3	80	6300	90,00	1	080420343
M48	5	90	8600	148,00	1	080420348
* M48F	3	90	8600	148,00	1	080420349

\*Tamanhos dimensionados de acordo com a Ficha Técnica Robur

### Embalagens especiais com blister



Ø mm	W mm	€	📦	🚚
M6	4	9,80	1	080429506
M8	4	9,80	1	080429508
M10	2	7,10	1	080429510
M12	1	4,90	1	080429312
* M14	1	5,80	1	080429314
M16	1	7,10	1	080429316
* M18	1	8,30	1	080429318
M20	1	10,00	1	080429320
* M22	1	13,00	1	080429322
M24	1	18,70	1	080429324
* M27	1	22,30	1	080429327
M30	1	34,00	1	080429330

## 8044

argolas fêmea, negras

CE



UNI 2948

### CARACTERÍSTICAS TÉCNICAS

- fator de segurança: 4
- tratamento térmico: normalizador
- código de identificação

### TESTES LABORATORIAIS

- análise química
- análise metalográfica
- ensaio de tração

### CERTIFICADOS DISPONÍVEIS

- Especificações técnicas
- Relatório de ensaio UNI EN10204 tipo 2.2
- Certificado de inspeção UNI EN10204 tipo 3.1
- Declaração de Conformidade CE

Ø mm	W mm	WLL kg	€	📦	🚚
M8	1,25	80	2,65	4	080440008
M10	1,5	160	4,30	4	080440010
M12	1,75	250	7,60	4	080440012
M14	2	250	12,30	2	080440014
M16	2	400	12,40	2	080440016
M20	2,5	630	20,80	2	080440020
M24	3	1000	36,00	2	080440024



# LINGAS DE CORRENTE

As lingas de corrente da Robur são fabricadas com **materiais de liga de alta resistência** e sujeitas a tratamento térmico de última geração, para que os nossos revendedores possam contar com produtos em conformidade com a norma técnica europeia, EN 818-4.

Com base nos materiais de elevada qualidade utilizados, as nossas lingas de corrente são adequadas para uma **utilização intensiva contínua**; podem ser utilizadas em segurança **numa ampla gama de temperaturas** (-40 °C ÷ +200 °C), sem reduzir a capacidade de carga.

As cargas devem ser suspensas por pessoal devidamente formado, de acordo com o Decreto Legislativo Italiano 81/2008; as lingas são fornecidas com etiquetas de identificação com os números de série e respetivos certificados de montagem (Certificados do Fabricante).



WLL Ton		UNI EN 818	
Ø D mm	WLL ↑	β	
		0° < β ≤ 45°	45° < β ≤ 60°
6	1,12	1,6	1,12
7	1,5	2,12	1,5
8	2	2,8	2
10	3,15	4,25	3,15
13	5,3	7,5	5,3
16	8	11,2	8
20	12,5	17	12,5

Ø D mm	WLL ↑	β	
		0° < β ≤ 45°	45° < β ≤ 60°
6	2,36	1,7	
7	3,15	2,24	
8	4,25	3	
10	6,7	4,75	
13	11,2	8	
16	17	11,2	
20	26,5	19	

## 8091

lingas de corrente, 1 secção em estojo de plástico

Dispositivo de bloqueio automático e ganchos a pedido

CE

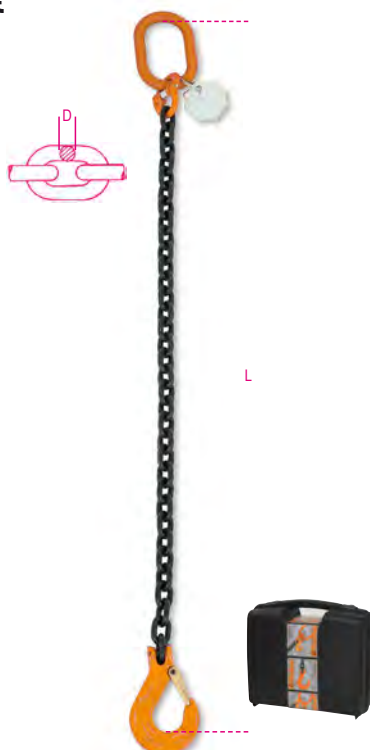

UNI EN 818-4

### CARACTERÍSTICAS TÉCNICAS

- factor de segurança: 4
- etiqueta de identificação
- CERTIFICADOS DISPONÍVEIS
- Certificado do fabricante UNI EN818-4
- Declaração de Conformidade CE
- CERTIFICADOS DISPONÍVEIS
- Especificações técnicas

D mm	L m	WLL ton	€	
6*	1	1,12	93,50	1 080910001
6*	2	1,12	115,00	1 080910002
6*	3	1,12	136,00	1 080910003
6*	4	1,12	156,00	1 080910004
7*	1	1,5	102,00	1 080910021
7*	2	1,5	129,00	1 080910022
7*	3	1,5	156,00	1 080910023
7*	4	1,5	183,00	1 080910024
8*	1	2	114,00	1 080910041
8*	2	2	146,00	1 080910042
8*	3	2	178,00	1 080910043
8*	4	2	223,00	1 080910044
10*	1	3,15	146,00	1 080910051
10*	2	3,15	193,00	1 080910052
10*	3	3,15	254,00	1 080910053
10*	4	3,15	301,00	1 080910054
13*	1	5,3	235,00	1 080910131
13*	2	5,3	316,00	1 080910132
13*	3	5,3	392,00	1 080910133
13*	4	5,3	472,00	1 080910134
16*	1	8	459,00	1 080910161
16*	2	8	580,00	1 080910162
16*	3	8	700,00	1 080910163
16*	4	8	825,00	1 080910164
20	1	12,5	900,00	1 080910171
20	2	12,5	1.130,00	1 080910172
20	3	12,5	1.360,00	1 080910173
20	4	12,5	1.600,00	1 080910174

\* Caixa de madeira apropriada ao peso

## 8091SL

lingas de corrente, 1 secção, gancho com autobloqueio, grau 8

CE

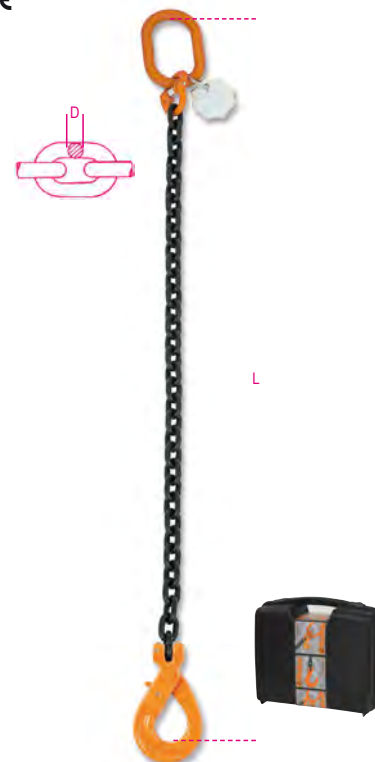

UNI EN 818-4

### CARACTERÍSTICAS TÉCNICAS

- factor de segurança: 4
- etiqueta de identificação
- CERTIFICADOS ANEXOS
- Certificado do fabricante UNI EN818-4
- Declaração de Conformidade CE
- CERTIFICADOS DISPONÍVEIS
- Especificações técnicas

D mm	L m	WLL ton	€	
6*	1	1,12	118,00	1 080910201
6*	2	1,12	139,00	1 080910202
6*	3	1,12	160,00	1 080910203
6*	4	1,12	180,00	1 080910204
7*	1	1,5	135,00	1 080910221
7*	2	1,5	162,00	1 080910222
7*	3	1,5	189,00	1 080910223
7*	4	1,5	215,00	1 080910224
8*	1	2	147,00	1 080910241
8*	2	2	172,00	1 080910242
8*	3	2	210,00	1 080910243
8*	4	2	256,00	1 080910244
10*	1	3,15	184,00	1 080910251
10*	2	3,15	230,00	1 080910252
10*	3	3,15	292,00	1 080910253
10*	4	3,15	353,00	1 080910254
13	0,6	5,3	284,00	1 080910330
13*	1	5,3	322,00	1 080910331
13*	2	5,3	427,00	1 080910332
13*	3	5,3	482,00	1 080910333
13*	4	5,3	585,00	1 080910334
16	0,6	8	575,00	1 080910360
16*	1	8	605,00	1 080910361
16*	2	8	765,00	1 080910362
16*	3	8	850,00	1 080910363
16*	4	8	1.010,00	1 080910364
20	1	12,5	1.420,00	1 080910401
20	2	12,5	1.650,00	1 080910402
20	3	12,5	1.890,00	1 080910403
20	4	12,5	2.110,00	1 080910404

\* Em estojo de plástico



**8092**lingas de corrente, 2 secções  
em estojo de plástico

Dispositivo de bloqueio automático e ganchos a pedido

CE



EN 818-4

**CARACTERÍSTICAS TÉCNICAS**

- factor de segurança: 4
- etiqueta de identificação
- CERTIFICADOS DISPONÍVEIS**
- Certificado do fabricante UNI EN818-4
- Declaração de Conformidade CE
- CERTIFICADOS DISPONÍVEIS**
- Especificações técnicas

D mm	L m	WLL ton	€	📄	📦
6*	1	1,6	137,00	1	080920001
6*	2	1,6	179,00	1	080920002
6*	3	1,6	221,00	1	080920003
6*	4	1,6	276,00	1	080920004
7*	1	2,12	160,00	1	080920021
7*	2	2,12	213,00	1	080920022
7*	3	2,12	281,00	1	080920023
7*	4	2,12	334,00	1	080920024
8*	1	2,8	181,00	1	080920041
8*	2	2,8	244,00	1	080920042
8*	3	2,8	321,00	1	080920043
8*	4	2,8	384,00	1	080920044
10*	1	4,25	262,00	1	080920051
10*	2	4,25	355,00	1	080920052
10*	3	4,25	446,00	1	080920053
10*	4	4,25	540,00	1	080920054
13*	1	7,5	416,00	1	080920131
13*	2	7,5	575,00	1	080920132
13	3	7,5	715,00	1	080920133
13	4	7,5	930,00	1	080920134
16*	1	11,2	835,00	1	080920161
16	2	11,2	1.110,00	1	080920162
16	3	11,2	1.360,00	1	080920163
16	4	11,2	1.600,00	1	080920164
20	2	17,0	2.240,00	1	080920172
20	3	17,0	2.710,00	1	080920173
20	4	17,0	3.180,00	1	080920174

\* Caixa de madeira apropriada ao peso

**Robur****8092SL**lingas de corrente,  
2 secções, gancho com autobloqueio, grau 8

CE



EN 818-4

**TECHNICAL DATA**

- fator de segurança: 4
- etiqueta de identificação
- CERTIFICADOS ANEXOS**
- Certificado do fabricante UNI EN818-4
- Declaração de Conformidade CE
- CERTIFICADOS DISPONÍVEIS**
- Especificações técnicas

D mm	L m	WLL ton	€	📄	📦
6*	1	1,6	186,00	1	080920201
6*	2	1,6	219,00	1	080920202
6*	3	1,6	261,00	1	080920203
6*	4	1,6	325,00	1	080920204
7*	1	2,12	224,00	1	080920221
7*	2	2,12	267,00	1	080920222
7*	3	2,12	345,00	1	080920223
7*	4	2,12	398,00	1	080920224
8*	1	2,8	233,00	1	080920241
8*	2	2,8	310,00	1	080920242
8*	3	2,8	373,00	1	080920243
8*	4	2,8	450,00	1	080920244
10*	1	4,25	365,00	1	080920251
10*	2	4,25	430,00	1	080920252
10*	3	4,25	525,00	1	080920253
10*	4	4,25	645,00	1	080920254
13*	1	7,5	640,00	1	080920331
13*	2	7,5	755,00	1	080920332
13*	3	7,5	935,00	1	080920333
13*	4	7,5	1.150,00	1	080920334
16*	1	11,2	1.200,00	1	080920361
16*	2	11,2	1.480,00	1	080920362
16*	3	11,2	1.730,00	1	080920363
16*	4	11,2	1.970,00	1	080920364
20	2	17,0	3.630,00	1	080920402
20	3	17,0	4.090,00	1	080920403
20	4	17,0	4.560,00	1	080920404

\* Em estojo de plástico

**8094**lingas de corrente, 4 secções  
em estojo de plástico

Dispositivo de bloqueio automático e ganchos a pedido

CE



EN 818-4

**CARACTERÍSTICAS TÉCNICAS**

- factor de segurança: 4
- etiqueta de identificação
- CERTIFICADOS DISPONÍVEIS**
- Certificado do fabricante UNI EN818-4
- Declaração de Conformidade CE
- CERTIFICADOS DISPONÍVEIS**
- Especificações técnicas

D mm	L m	WLL ton	€	📄	📦
6*	1	2,36	285,00	1	080940001
6*	2	2,36	382,00	1	080940002
6*	3	2,36	466,00	1	080940003
6*	4	2,36	545,00	1	080940004
7*	1	3,15	334,00	1	080940021
7*	2	3,15	441,00	1	080940022
7*	3	3,15	545,00	1	080940023
7*	4	3,15	655,00	1	080940024
8*	1	4,25	403,00	1	080940041
8*	2	4,25	530,00	1	080940042
8*	3	4,25	655,00	1	080940043
8	4	4,25	815,00	1	080940044
10*	1	6,7	530,00	1	080940051
10	2	6,7	735,00	1	080940052
10	3	6,7	940,00	1	080940053
10	4	6,7	1.130,00	1	080940054
13	1	11,2	885,00	1	080940131
13	2	11,2	1.210,00	1	080940132
13	3	11,2	1.530,00	1	080940133
13	4	11,2	1.850,00	1	080940134
16	1	17	1.740,00	1	080940161
16	2	17	2.220,00	1	080940162
16	3	17	2.710,00	1	080940163
16	4	17	3.200,00	1	080940164
20	2	26,5	4.070,00	1	080940172
20	3	26,5	5.000,00	1	080940173
20	4	26,5	5.950,00	1	080940174

\* Caixa de madeira apropriada ao peso

**Robur****Robur**



# Robur

## 8094SL

lingas de corrente,  
4 secções, gancho com autobloqueio, grau 8

CE



EN 818-4

### CARACTERÍSTICAS TÉCNICAS

- fator de segurança: 4
- etiqueta de identificação
- CERTIFICADOS ANEXOS
- Certificado do fabricante UNI EN818-4
- Declaração de Conformidade CE
- CERTIFICADOS DISPONÍVEIS
- Especificações técnicas

D mm	L m	WLL ton	€		
6*	1	2,36	382,00	1	080940201
6*	2	2,36	479,00	1	080940202
6*	3	2,36	565,00	1	080940203
6*	4	2,36	645,00	1	080940204
7*	1	3,15	463,00	1	080940221
7*	2	3,15	570,00	1	080940222
7*	3	3,15	675,00	1	080940223
7*	4	3,15	785,00	1	080940224
8*	1	4,25	510,00	1	080940241
8*	2	4,25	635,00	1	080940242
8*	3	4,25	785,00	1	080940243
8	4	4,25	945,00	1	080940244
10*	1	6,7	690,00	1	080940251
10	2	6,7	885,00	1	080940252
10	3	6,7	1.100,00	1	080940253
10	4	6,7	1.290,00	1	080940254
13	1	11,2	1.250,00	1	080940331
13	2	11,2	1.570,00	1	080940332
13	3	11,2	1.890,00	1	080940333
13	4	11,2	2.210,00	1	080940334
16	1	17	2.350,00	1	080940361
16	2	17	2.840,00	1	080940362
16	3	17	3.330,00	1	080940363
16	4	17	3.810,00	1	080940364
20	2	26,5	6.150,00	1	080940402
20	3	26,5	7.100,00	1	080940403
20	4	26,5	8.000,00	1	080940404

\* Em estojo de plástico

## 8096

lingas de corrente, 1 secção,  
com gancho Clevis,  
em estojo de plástico

CE



EN 818-4

### CARACTERÍSTICAS TÉCNICAS

- fator de segurança: 4
- etiqueta de identificação
- CERTIFICADOS DISPONÍVEIS
- Certificado do fabricante UNI EN818-4
- Declaração de Conformidade CE
- CERTIFICADOS DISPONÍVEIS
- Especificações técnicas

D mm	L m	WLL ton	€		
6*	1	1,12	111,00	1	080960001
6*	2	1,12	132,00	1	080960002
6*	3	1,12	153,00	1	080960003
6*	4	1,12	169,00	1	080960004
7*	1	1,5	123,00	1	080960021
7*	2	1,5	150,00	1	080960022
7*	3	1,5	171,00	1	080960023
7*	4	1,5	198,00	1	080960024
8*	1	2	136,00	1	080960041
8*	2	2	167,00	1	080960042
8*	3	2	199,00	1	080960043
8*	4	2	245,00	1	080960044
10*	1	3,15	187,00	1	080960051
10*	2	3,15	248,00	1	080960052
10*	3	3,15	295,00	1	080960053
10*	4	3,15	342,00	1	080960054
13*	1	5,3	307,00	1	080960131
13*	2	5,3	363,00	1	080960132
13*	3	5,3	440,00	1	080960133
13*	4	5,3	545,00	1	080960134
16*	1	8	605,00	1	080960161
16*	2	8	690,00	1	080960162
16*	3	8	810,00	1	080960163
16	4	8	965,00	1	080960164
20	1	12,5	1.230,00	1	080960171
20	2	12,5	1.460,00	1	080960172
20	3	12,5	1.690,00	1	080960173
20	4	12,5	1.920,00	1	080960174

\* Embalagem de madeira adequada ao peso

## 8096SL

lingas de corrente,  
1 secção, com ganchos de autobloqueio e  
clevis, grau 8

CE



EN 818-4

### CARACTERÍSTICAS TÉCNICAS

- fator de segurança: 4
- etiqueta de identificação
- CERTIFICADOS ANEXOS
- Certificado do fabricante UNI EN818-4
- Declaração de Conformidade CE
- CERTIFICADOS DISPONÍVEIS
- Especificações técnicas

D mm	L m	WLL ton	€		
6*	1	1,12	131,00	1	080960201
6*	2	1,12	152,00	1	080960202
6*	3	1,12	173,00	1	080960203
6*	4	1,12	193,00	1	080960204
7*	1	1,5	150,00	1	080960221
7*	2	1,5	177,00	1	080960222
7*	3	1,5	203,00	1	080960223
7*	4	1,5	230,00	1	080960224
8*	1	2	162,00	1	080960241
8*	2	2	193,00	1	080960242
8*	3	2	225,00	1	080960243
8*	4	2	271,00	1	080960244
10*	1	3,15	225,00	1	080960251
10*	2	3,15	286,00	1	080960252
10*	3	3,15	333,00	1	080960253
10*	4	3,15	380,00	1	080960254
13*	1	5,3	394,00	1	080960331
13*	2	5,3	475,00	1	080960332
13*	3	5,3	555,00	1	080960333
13*	4	5,3	635,00	1	080960334
16*	1	8	750,00	1	080960361
16*	2	8	870,00	1	080960362
16*	3	8	995,00	1	080960363
16	4	8	1.110,00	1	080960364
20	1	12,5	1.750,00	1	080960401
20	2	12,5	1.980,00	1	080960402
20	3	12,5	2.210,00	1	080960403
20	4	12,5	2.440,00	1	080960404

\* Em estojo de plástico

## 8097

lingas de corrente, 2 secções,  
com ganchos Clevis,  
em estojo de plástico

CE



EN 818-4

### CARACTERÍSTICAS TÉCNICAS

- factor de segurança: 4
- etiqueta de identificação
- CERTIFICADOS DISPONÍVEIS
- Certificado do fabricante UNI EN818-4
- Declaração de Conformidade CE
- CERTIFICADOS DISPONÍVEIS
- Especificações técnicas

D mm	L m	WLL ton	€	📄	📄
6*	1	1,6	172,00	1	080970001
6*	2	1,6	205,00	1	080970002
6*	3	1,6	255,00	1	080970003
6*	4	1,6	302,00	1	080970004
7*	1	2,12	200,00	1	080970021
7*	2	2,12	257,00	1	080970022
7*	3	2,12	310,00	1	080970023
7*	4	2,12	363,00	1	080970024
8*	1	2,8	223,00	1	080970041
8*	2	2,8	288,00	1	080970042
8*	3	2,8	363,00	1	080970043
8*	4	2,8	427,00	1	080970044
10*	1	4,25	344,00	1	080970051
10*	2	4,25	438,00	1	080970052
10*	3	4,25	530,00	1	080970053
10*	4	4,25	625,00	1	080970054
13*	1	7,5	560,00	1	080970131
13*	2	7,5	720,00	1	080970132
13	3	7,5	865,00	1	080970133
13	4	7,5	1.030,00	1	080970134
16	1	11,2	1.090,00	1	080970161
16	2	11,2	1.330,00	1	080970162
16	3	11,2	1.570,00	1	080970163
16	4	11,2	1.810,00	1	080970164
20	2	17,0	2.590,00	1	080970172
20	3	17,0	3.060,00	1	080970173
20	4	17,0	3.510,00	1	080970174

\* Embalagem de madeira adequada ao peso

# Robur

## 8097SL

lingas de corrente,  
2 secções, com ganchos de autobloqueio e  
clevis, grau 8

CE



EN 818-4

### CARACTERÍSTICAS TÉCNICAS

- fator de segurança: 4
- etiqueta de identificação
- CERTIFICADOS ANEXOS
- Certificado do fabricante UNI EN818-4
- Declaração de Conformidade CE
- CERTIFICADOS DISPONÍVEIS
- Especificações técnicas

D mm	L m	WLL ton	€	📄	📄
6*	1	1,6	212,00	1	080970201
6*	2	1,6	245,00	1	080970202
6*	3	1,6	296,00	1	080970203
6*	4	1,6	351,00	1	080970204
7*	1	2,12	254,00	1	080970221
7*	2	2,12	311,00	1	080970222
7*	3	2,12	365,00	1	080970223
7*	4	2,12	418,00	1	080970224
8*	1	2,8	276,00	1	080970241
8*	2	2,8	341,00	1	080970242
8*	3	2,8	416,00	1	080970243
8*	4	2,8	479,00	1	080970244
10*	1	4,25	419,00	1	080970251
10*	2	4,25	515,00	1	080970252
10*	3	4,25	605,00	1	080970253
10*	4	4,25	700,00	1	080970254
13*	1	7,5	735,00	1	080970331
13*	2	7,5	895,00	1	080970332
13	3	7,5	1.090,00	1	080970333
13	4	7,5	1.200,00	1	080970334
16	1	11,2	1.450,00	1	080970361
16	2	11,2	1.690,00	1	080970362
16	3	11,2	1.940,00	1	080970363
16	4	11,2	2.110,00	1	080970364
20	2	17,0	3.630,00	1	080970402
20	3	17,0	4.090,00	1	080970403
20	4	17,0	4.560,00	1	080970404

\* Em estojo de plástico

## 8098

lingas de corrente, 4 secções,  
com ganchos Clevis,  
em estojo de plástico

CE



EN 818-4

### CARACTERÍSTICAS TÉCNICAS

- factor de segurança: 4
- etiqueta de identificação
- CERTIFICADOS DISPONÍVEIS
- Certificado do fabricante UNI EN818-4
- Declaração de Conformidade CE
- CERTIFICADOS DISPONÍVEIS
- Especificações técnicas

D mm	L m	WLL ton	€	📄	📄
6*	1	2,36	354,00	1	080980001
6*	2	2,36	434,00	1	080980002
6*	3	2,36	515,00	1	080980003
6*	4	2,36	600,00	1	080980004
7*	1	3,15	415,00	1	080980021
7*	2	3,15	505,00	1	080980022
7*	3	3,15	605,00	1	080980023
7*	4	3,15	715,00	1	080980024
8*	1	4,25	463,00	1	080980041
8*	2	4,25	590,00	1	080980042
8*	3	4,25	715,00	1	080980043
8	4	4,25	875,00	1	080980044
10*	1	6,7	640,00	1	080980051
10	2	6,7	860,00	1	080980052
10	3	6,7	1.050,00	1	080980053
10	4	6,7	1.240,00	1	080980054
13	1	11,2	1.080,00	1	080980131
13	2	11,2	1.400,00	1	080980132
13	3	11,2	1.740,00	1	080980133
13	4	11,2	2.040,00	1	080980134
16	1	17	2.170,00	1	080980161
16	2	17	2.650,00	1	080980162
16	3	17	3.140,00	1	080980163
16	4	17	3.630,00	1	080980164
20	2	26,5	5.150,00	1	080980172
20	3	26,5	6.100,00	1	080980173
20	4	26,5	7.000,00	1	080980174

\* Embalagem de madeira adequada ao peso

# Robur

## 8098SL

lingas de corrente,  
4 secções, ganchos clevis com autobloqueio,  
grau 8

CE



EN 818-4

### CARACTERÍSTICAS TÉCNICAS

- fator de segurança: 4
  - etiqueta de identificação
- CERTIFICADOS ANEXOS**
- Certificado do fabricante UNI EN818-4
  - Declaração de Conformidade CE
- CERTIFICADOS DISPONÍVEIS**
- Especificações técnicas

D mm	L m	WLL ton	€	📄	📁
6*	1	2,36	434,00	1	080980201
6*	2	2,36	535,00	1	080980202
6*	3	2,36	595,00	1	080980203
6*	4	2,36	695,00	1	080980204
7*	1	3,15	525,00	1	080980221
7*	2	3,15	610,00	1	080980222
7*	3	3,15	715,00	1	080980223
7*	4	3,15	820,00	1	080980224
8*	1	4,25	595,00	1	080980241
8*	2	4,25	690,00	1	080980242
8*	3	4,25	820,00	1	080980243
8*	4	4,25	980,00	1	080980244
10*	1	6,7	790,00	1	080980251
10	2	6,7	1.010,00	1	080980252
10	3	6,7	1.200,00	1	080980253
10	4	6,7	1.390,00	1	080980254
13	1	11,2	1.430,00	1	080980331
13	2	11,2	1.750,00	1	080980332
13	3	11,2	2.090,00	1	080980333
13	4	11,2	2.390,00	1	080980334
16	1	17	2.770,00	1	080980361
16	2	17	3.260,00	1	080980362
16	3	17	3.750,00	1	080980363
16	4	17	4.220,00	1	080980364
20	2	26,5	7.250,00	1	080980402
20	3	26,5	8.200,00	1	080980403
20	4	26,5	9.100,00	1	080980404

\* Em estajo de plástico



## 8100

correntes de elevação,  
liga de aço muito resistente

CE

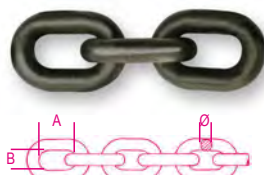

EN 818-2

### CARACTERÍSTICAS TÉCNICAS

- fator de segurança: 4
  - tratamento a quente: reforçado e temperado
- TESTES LABORATORIAIS**
- análise química
  - análise metalográfica
  - teste de elasticidade
- CERTIFICADOS DISPONÍVEIS**
- Especificações de produto
  - Relatório de Teste UNI EN10204 tipo 2.2
  - Certificado do Fabricante EN818-2
  - Declaração de Conformidade CE

WLL kg	Ø mm	A mm	B mm	€/m	📄	📁
1120	6	18	7,8	22,10	1	081000011
1500	7	21	9,1	28,50	1	081000016
2000	8	24	10,4	33,50	1	081000020
3150	10	30	13,0	49,50	1	081000032
5300	13	39	16,9	85,50	1	081000053
8000	16	48	20,8	130,00	1	081000080
12500	20	60	26,0	232,00	1	081000125

## 8085R

anéis de elevação, em liga de aço de alta  
resistência

WLL refere-se à utilização com eslingas de 1 corrente

CE



EN 1677-4

### CARACTERÍSTICAS TÉCNICAS

- fator de segurança: 4
  - tratamento térmico: endurecido
- TESTES LABORATORIAIS**
- análise química, análise metalográfica
  - ensaio de carga (WLL x 2.5)
  - ensaio de tensão
  - teste de fadiga (min. 20.000 ciclos)
- CERTIFICADOS DISPONÍVEIS**
- Especificações técnicas
  - Relatório de teste UNI EN10204 tipo 2.2
  - Certificado de inspeção UNI EN10204 tipo 3.1
  - Declaração de Conformidade CE

WLL kg	Ø mm	A mm	B mm	€	📄	📁
* 1600	7	110	60	11,70	1	080850215
** 2120	8	110	60	16,60	1	080850220
3150	10	135	75	23,50	1	080850232
5300	13	160	90	41,00	1	080850253
8000	16	180	100	82,50	1	080850280
11200	19	200	110	134,00	1	080850311
16000	20	260	140	220,00	1	080850316
17000	22	300	160	312,00	1	080850317

\* Com corrente Ø 6, WLL= 1120 kg

## 8086

anéis tripos em liga de aço,  
alta resistência

CE



EN 1677-4

### CARACTERÍSTICAS TÉCNICAS

- fator de segurança: 4
  - tratamento térmico: endurecido e temperado
- TESTES LABORATORIAIS**
- análise química, análise metalográfica
  - ensaio de carga (WLL x 2.5)
  - ensaio de tração
  - teste de fadiga (min. 20.000 ciclos)
- CERTIFICADOS DISPONÍVEIS**
- Especificações técnicas
  - Relatório de ensaio UNI EN10204 tipo 2.2
  - Certificado de inspeção UNI EN10204 tipo 3.1
  - Declaração de conformidade CE

WLL kg	Ø mm	B mm	C mm	€	📄	📁
* 3150	7	135	75	76,00	1	080860021
4250	8	160	90	117,00	1	080860042
6700	10	180	100	150,00	1	080860067
11200	13	200	110	244,00	1	080860100
17000	16	260	140	356,00	1	080860117
21200	18	340	180	640,00	1	080860121
26500	20	350	190	905,00	1	080860126

\* Acoplado a corrente Ø 7 mm, WLL = 3150 Kg

## 8090R

malha de junção em liga de aço,  
alta resistência

CE

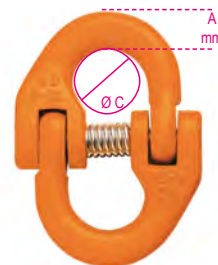

EN 1677-1

### CARACTERÍSTICAS TÉCNICAS

- fator de segurança: 4
  - tratamento térmico: endurecido e temperado
- TESTES LABORATORIAIS**
- análise química, análise metalográfica
  - ensaio de carga (WLL x 2.5)
  - ensaio de tração
  - teste de fadiga (min. 20.000 ciclos)
- CERTIFICADOS DISPONÍVEIS**
- Especificações técnicas
  - Relatório de ensaio UNI EN10204 tipo 2.2
  - Certificado de inspeção UNI EN10204 tipo 3.1
  - Declaração de Conformidade CE

WLL kg	Ø mm	ØC max	A mm	€	📄	📁
1120	6	13	7,5	10,00	1	080900111
1500	7	18	9	12,90	1	080900115
2000	8	18	11	15,70	1	080900120
3150	10	22	13,0	19,20	1	080900131
5300	13	30	16	35,00	1	080900153
8000	16	32	22	76,00	1	080900180
12500	20	40	25	174,00	1	080900312



## 8060R

ganchos Clevis para elevação,  
em liga de aço de elevada resistência

CE



EN 1677-2

### CARACTERÍSTICAS TÉCNICAS

- factor de segurança: 4
- tratamento a quente: endurecimento e reforço
- código de deteção no pino, fecho de segurança, estrutura

### TESTES LABORATORIAIS

- análise química, análise metalográfica
- teste de elasticidade
- teste de fadiga (min. 20.000 ciclos)
- teste prova de carga (2.5 x WLL)

### CERTIFICADOS DISPONÍVEIS

- Especificações do Produto
- Relatório de Teste UNI EN10204 tipo 2.2
- Certificado de Inspeção UNI EN10204 tipo 3.1
- Declaração de Conformidade CE

WLL	Ø mm	C	€	📄	🖨️
1120	6	19	18,70	1	080600111
1500	7	19	20,00	1	080600115
2000	8	21	20,90	1	080600120
3150	10	27	36,00	1	080600132
5300	13	35	57,50	1	080600153
8000	16	48	183,00	1	080600180
12500	20	54	324,00	1	080600225

## 8058R

ganchos de elevação self-locking,  
tipo Clevis,  
em liga de aço de alta resistência

CE



EN 1677-3

### CARACTERÍSTICAS TÉCNICAS

- factor de segurança: 4
- tratamento térmico: endurecido e temperado
- código de identificação

### TESTES LABORATORIAIS

- análise química, análise metalográfica
- ensaio de tracção
- teste de fadiga (min. 20.000 ciclos)
- teste prova de carga (100% do lote)

### CERTIFICADOS DISPONÍVEIS

- Especificações técnicas
- Relatório de ensaio UNI EN10204 tipo 2.2
- Certificado de inspeção UNI EN10204 tipo 3.1
- Declaração de Conformidade CE

WLL	Ø mm	J min	€	📄	🖨️
1120	6	28	40,00	1	080580112
2000	7-8	34	48,50	1	080580120
3150	10	44	76,00	1	080580132
5300	13	52	150,00	1	080580153
8000	16	67	338,00	1	080580180
12500	20	77	845,00	1	080580225

## 8061R

ganchos Clevis  
com bloqueio de segurança,  
em liga de aço de alta resistência

CE



EN 1677-1

### CARACTERÍSTICAS TÉCNICAS

- factor de segurança: 4
- tratamento térmico: endurecido e temperado
- código de identificação

### TESTES LABORATORIAIS

- análise química, análise metalográfica
- ensaio de tracção
- teste de fadiga (min. 20.000 ciclos)
- teste prova de carga (100% do lote)

### CERTIFICADOS DISPONÍVEIS

- Especificações técnicas
- Relatório de ensaio UNI EN10204 tipo 2.2
- Certificado de inspeção UNI EN10204 tipo 3.1
- Declaração de Conformidade CE

WLL	Ø mm	E	€	📄	🖨️
1120	6	8	13,90	1	080610211
2000	7-8	11	15,90	1	080610220
3150	10	13	29,00	1	080610231
5300	13	17	51,00	1	080610253
8000	16	20	114,00	1	080610280
12500	20	24	272,00	1	080610312

## 8052

ganchos de elevação tipo americano  
de alta resistência em liga de aço

CE



EN 1677-2

### CARACTERÍSTICAS TÉCNICAS

- factor de segurança: 4
- tratamento a quente: endurecimento e reforço
- código de deteção

### TESTES LABORATORIAIS

- análise química, análise metalográfica
- teste de elasticidade
- teste de fadiga (min. 20.000 ciclos)
- teste prova de carga (2 x WLL)

### CERTIFICADOS DISPONÍVEIS

- Especificações Técnicas
- Relatório de Teste UNI EN10204 tipo 2.2
- Certificado de Inspeção UNI EN10204 tipo 3.1
- Declaração de Conformidade CE

WLL	C	€	📄	🖨️
8052 0,8	800 18	7,10	1	080520008
8052 1,12	1120 22,5	9,50	1	080520011
8052 2	2000 30	20,10	1	080520020
8052 3,15	3150 36	30,50	1	080520031
8052 4	4000 39,5	40,00	1	080520040

WLL	A	E	€	📄	🖨️
8055S 5,4	5400 40	77,50	1	080550145	
8055S 8,0	8000 51	136,00	1	080550170	
8055S 11,5	11500 58	270,00	1	080550215	
8055S 16,0	16000 66	362,00	1	080550260	
8055S 22,0	22000 87	850,00	1	080550320	

## 8057R

ganchos de elevação self-locking,  
com olhal,  
em liga de aço de alta resistência

CE



EN 1677-3

### CARACTERÍSTICAS TÉCNICAS

- factor de segurança: 4
- tratamento térmico: endurecido e temperado
- código de identificação

### TESTES LABORATORIAIS

- análise química, análise metalográfica
- ensaio de tracção
- teste de fadiga (min. 20.000 ciclos)
- teste prova de carga (100% do lote)

### CERTIFICADOS DISPONÍVEIS

- Especificações técnicas
- Relatório de ensaio UNI EN10204 tipo 2.2
- Certificado de inspeção UNI EN10204 tipo 3.1
- Declaração de Conformidade CE

WLL	Ø mm	J min	ØB	€	📄	🖨️
1120	6	28	22	32,00	1	080570112
2000	7-8	34	25	38,00	1	080570120
3150	10	44	32	69,00	1	080570132
5300	13	54	40	240,00	1	080570153

## 8063

ganchos giratórios  
em liga de aço de alta resistência

CE



EN 1677-1

### CARACTERÍSTICAS TÉCNICAS

- factor de segurança: 4
- tratamento térmico: endurecido e temperado
- código de identificação

### TESTES LABORATORIAIS

- análise química, análise metalográfica
- ensaio de tracção
- teste de fadiga (min. 20.000 ciclos)
- teste prova de carga (100% do lote)

### CERTIFICADOS DISPONÍVEIS

- Especificações técnicas
- Relatório de ensaio UNI EN10204 tipo 2.2
- Certificado de inspeção UNI EN10204 tipo 3.1
- Declaração de Conformidade CE

WLL	A	E	€	📄	🖨️
800	32	20,5	15,90	1	080630008
1120	38	20,5	20,00	1	080630011
2000	44,5	22	24,40	1	080630020
3150	44,5	27	30,00	1	080630031

## 8063SL

ganchos de elevação giratórios com bloqueio automático  
(não sob carga)  
liga de aço de elevada resistência  
grau 8

CE

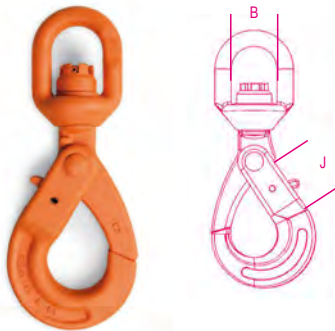

EN 1677-1

**Características técnicas:**

- fator de segurança: 4
- tratamento térmico: endurecido e temperado
- código de identificação

**TESTES LABORATORIAIS**

- análise química, análise metalográfica
- ensaio de tensão

- teste de fadiga (min. 20.000 ciclos)
- teste de carga (100% da produção)

**CERTIFICADOS DISPONÍVEIS**

- Especificações técnicas
- Relatório de teste UNI EN10204 tipo 2.2
- Certificado de inspeção UNI EN10204 tipo 3.1
- Declaração de Conformidade CE

WLL kg	Ø mm	B mm	J mm	€	📦	📄
1120	6	32	45	41,50	1	080630311
2000	8	35	59	58,00	1	080630320
3150	10	42	54	101,00	1	080630331
5300	13	49	83	154,00	1	080630353

## 8064S

ganchos giratórios em aço carbono,  
alta resistência

CE



EN 1677-5

**Características técnicas:**

- fator de segurança: 5
- tratamento térmico: endurecido e temperado
- código de identificação

**TESTES LABORATORIAIS**

- análise química, análise metalográfica
- ensaio de carga (WLL x 2.5)

- ensaio de tração
- teste de fadiga (min. 20.000 ciclos)

**CERTIFICADOS DISPONÍVEIS**

- Especificações técnicas
- Relatório de ensaio UNI EN10204 tipo 2.2
- Certificado de inspeção UNI EN10204 tipo 3.1
- Declaração de Conformidade CE

WLL kg	B mm	C mm	€	📦	📄
800	31	20	38,50	1	080640107
1000	40	22	54,50	1	080640110
1600	47	23	71,50	1	080640115
2000	47	27	78,00	1	080640120
3200	64	35	137,00	1	080640130
5000	77	43	250,00	1	080640150
7500	90	53	363,00	1	080640175
10000	96	58	605,00	1	080640199

## 8065SC

ganchos de elevação giratórios,  
aço carbono, elevada resistência

CE



EN 1677-5

**Características técnicas:**

- fator de segurança: 5
- tratamento térmico: endurecido e temperado
- código de identificação

**TESTES LABORATORIAIS**

- análise química, análise metalográfica
- ensaio de carga (WLL x 2.5)

- ensaio de tração
- teste de fadiga (min. 20.000 ciclos)

**CERTIFICADOS DISPONÍVEIS**

- Especificações técnicas
- Relatório de ensaio UNI EN10204 tipo 2.2
- Certificado de inspeção UNI EN10204 tipo 3.1
- Declaração de Conformidade CE

WLL kg	B mm	C mm	€	📦	📄
800	38	20	77,50	1	080650107
1000	38	22	84,50	1	080650110
1600	47	23	105,00	1	080650115
2000	47	27	120,00	1	080650120
3200	54	35	210,00	1	080650130
5000	72	43	311,00	1	080650150
7500	82	53	530,00	1	080650175

## 8062

gancho corredeiro em liga de aço

CE

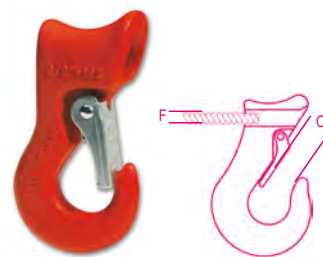
**Características técnicas:**

- fator de segurança: 5
- tratamento térmico: endurecido e temperado
- código de identificação

**TESTES LABORATORIAIS**

- análise química, análise metalográfica
- ensaio de carga (WLL x 2.5)

- ensaio de tração
- teste de fadiga (min. 20.000 ciclos)

**CERTIFICADOS DISPONÍVEIS**

- Especificações técnicas
- Relatório de ensaio UNI EN10204 tipo 2.2
- Certificado de inspeção UNI EN10204 tipo 3.1
- Declaração de Conformidade CE

WLL kg	C mm	F mm	€	📦	📄
1500	19	10-13	47,00	1	080620013
2000	21	16	66,00	1	080620016
3000	26	18	111,00	1	080620018

## 8051S

ganchos com olhal em aço carbono,  
zincados

CE

**Características técnicas:**

- fator de segurança: 4
- tratamento térmico: normalizador
- código de identificação

**TESTES LABORATORIAIS**

- análise química
- análise metalográfica

- ensaio de tração

**CERTIFICADOS DISPONÍVEIS**

- Especificações técnicas
- Relatório de ensaio UNI EN10204 tipo 2.2
- Certificado de inspeção UNI EN10204 tipo 3.1
- Declaração de Conformidade CE

WLL kg	C mm	F mm	€	📦	📄
250	14	12	3,45	10	080510202
500	18	16,5	7,60	5	080510205

Embalagens especiais com blister



WLL kg	📦	€	📦	📄
250	1	4,85	1	080519202
500	1	9,40	1	080519205

## 8134

ímã de elevação

CE

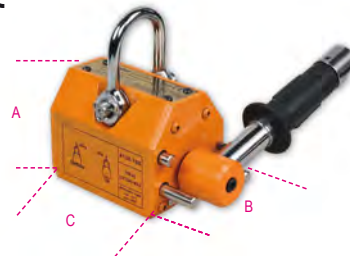

EN13155

**Características técnicas:**

- Fator de segurança: 3
- Etiqueta de identificação

**Certificados disponíveis:**

- Certificado do Fabricante
- Declaração de Conformidade com Diretiva de Máquinas 2006/42/EC
- Relatório de Teste UNI EN10204 tipo 2.2
- Manual de funcionamento e manutenção

WLL kg	A mm	B mm	D mm	€	📦	📄
100	70	64	92	499,00	1	081340010
300	96	88	165	875,00	1	081340030
600	120	118	236	1.630,00	1	081340060
1000	168	168	264	2.690,00	1	081340100

## 8135

gancho de elevação em aço com olhais articulados

CE



EN13155

### CARACTERÍSTICAS TÉCNICAS

- Fator de segurança: 3
  - Placa de identificação do número de série
- CERTIFICADOS DISPONÍVEIS**
- Certificado do Fabricante
  - Declaração de Conformidade CE
  - Relatório de teste UNI EN10204 tipo 2.2
  - Especificações técnicas do produto

WLL t	A mm	E mm	kg	€		
0,75	0-15	2	2	143,00	1	081350005
1,0	0-20	5	5	193,00	1	081350010
2,0	0-25	8	8	287,00	1	081350020
3,0	0-30	15	15	487,00	1	081350032
5,0	0-50	23	23	685,00	1	081350050

## 8135H

gancho de elevação horizontal para superfícies planas, dureza máx. 30HRC/300HB

CE



EN13155

### Características técnicas:

- Fator de segurança: 3
- Placa de identificação do número de série

### Certificados disponíveis:

- Certificado do Fabricante
- Declaração de Conformidade CE
- Relatório de teste UNI EN10204 tipo 2.2

WLL t	A mm	E mm	kg	€		
0,75	25	22	2,5	137,00	1	081350307
1,5	30	25	4,0	179,00	1	081350315
3,0	45	30	6,0	264,00	1	081350330



## DIFERENCIAIS COM AUTO-BLOQUEIO

Os diferenciais Robur, que cumprem a norma europeia EN 13157 e têm certificação TÜV, são modelos profissionais fabricados com materiais de primeira qualidade, concebidos para uma utilização intensiva.

Para além da linha standard, fornecemos também talhas com comprimentos de corrente personalizados e ganchos giratórios auto-blocantes, para bloqueio automático em condições de carga, visando satisfazer as necessidades individuais.



## 8143

diferencial de corrente manual

CE



EN13157



WLL t	L m	storszo / effort kg	€		
0,5	3	27	231,00	1	081430005
1	3	44	272,00	1	081430010
1,5	3	44	360,00	1	081430015
2	3	44	395,00	1	081430020
3	3	45	510,00	1	081430030
5	3	47	760,00	1	081430050
10	3	52	1.550,00	1	081430100

0,5	6	27	346,00	1	081430105
1	6	44	389,00	1	081430110
1,5	6	44	505,00	1	081430115
2	6	44	550,00	1	081430120
3	6	45	785,00	1	081430130
5	6	47	1.110,00	1	081430150
10	6	52	2.230,00	1	081430200

## 8143SL

diferencial de corrente manual com gancho com bloqueio de segurança

CE



EN13157



### Características técnicas:

- Fator de segurança: 4
- Etiqueta de identificação de série

### Certificados disponíveis:

- Certificado do Fabricante
- Declaração de Conformidade CE
- Relatório de Ensaio UNI EN10204 tipo 2.2
- Especificações Técnicas do Produto

WLL t	L m	storszo / effort kg	€		
1	3	44	324,00	1	081430310
2	3	44	428,00	1	081430320

1	6	44	433,00	1	081430410
2	6	44	565,00	1	081430420

# Robur

# Robur



## 8146

diferencial de alavanca

CE



EN13157

WLL t	L m	sforzo / effort kg	€	📄	📄
0,75	1,5	21*	282,00	1	081460008
1,5	1,5	41*	401,00	1	081460015
3,0	1,5	41	540,00	1	081460030
6,0	1,5	46	870,00	1	081460060

0,75	3,0	21*	316,00	1	081460108
1,5	3,0	41*	445,00	1	081460115
3,0	3,0	41	615,00	1	081460130
6,0	3,0	46	1.050,00	1	081460160

H= distância mínima entre ganchos

(\*) equipadas com sistema de protecao de sobrecarga

# Robur

## 8146C

diferencial de alavanca, compacto

CE



## 8146SL

diferencial de alavanca  
com gancho com bloqueio de segurança

CE



EN13157

### CARACTERÍSTICAS TÉCNICAS

- Fator de segurança: 4
- Etiqueta de identificação de série CERTIFICADOS DISPONÍVEIS
- Certificado do fabricante
- Declaração de Conformidade CE
- Relatório de ensaio UNI EN10204 tipo 2.2
- Especificações técnicas do produto

WLL t	L m	sforzo / effort kg	€	📄	📄
0,75	1,5	21	355,00	1	081460308
1,5	1,5	41	466,00	1	081460315
3,0	1,5	41	615,00	1	081460330

0,75	3,0	21	385,00	1	081460408
1,5	3,0	41	515,00	1	081460415
3,0	3,0	41	695,00	1	081460430

WLL t	L m	sforzo / effort kg	€	📄	📄
0,25	1,5	20,7	259,00	1	081460002

H= distância mínima entre ganchos

# Robur

# TROLLEY PARA GUINCHO MANUAL

Concebidos em conformidade com a norma EN 13157, os **trolleys para guinchos manuais** suportam eficazmente a movimentação de cargas pesadas.

As **rodas com rolamentos, proteção de fim de curso, patilhas anti-descarrilamento e parafuso central de aço normalizado** traduzem-se em produtos de fixação seguros e firmes.

Os guinchos manuais representam uma solução simples e conveniente para a **suspensão temporária ou semipermanente em vigas estruturais**.

A **rastreabilidade completa** dos nossos produtos é garantida pela etiqueta de identificação com número de lote e número de série.



## 8147C

trolley de corrente para guincho manual adequado para vigas estruturais (INP, IPB, IPE, HEA, HEB etc.)



EN 13157

Características técnicas:  
• Fator de segurança: 4  
• Etiqueta de identificação

Certificados disponíveis:  
• Certificado do Fabricante  
• Declaração de Conformidade CE  
• Relatório de teste UNI EN10204 tipo 2.2  
• Especificações técnicas do produto

WLL t	L min mm	L max mm	Lm	€	📄	📄
1,0	58	220	3	288,00	1	081470510
2,0	66	220	3	369,00	1	081470520
3,0	74	220	3	565,00	1	081470530
5,0	90	220	3	780,00	1	081470550

Artigo fornecido desmontado: deve ser montado antes da utilização de acordo com o manual de instruções.

## 8147S

trolley para guincho manual

adequado para vigas estruturais (INP, IPB, IPE, HEA, HEB etc.)

CE



EN 13157

Características técnicas:  
• Fator de segurança: 4  
• Etiqueta de identificação

Certificados disponíveis:  
• Certificado do Fabricante  
• Declaração de Conformidade CE  
• Relatório de teste UNI EN10204 tipo 2.2  
• Especificações técnicas do produto

WLL t	L min mm	L max mm	øF mm	€	📄	📄
0,5	50	220	25	186,00	1	081470005
1,0	58	220	30	238,00	1	081470010
2,0	66	220	40	302,00	1	081470020

Artigo fornecido desmontado: deve ser montado antes da utilização de acordo com o manual de instruções.

## 8147P

grampo para viga para guincho manual adequado para vigas estruturais (INP, IPB, IPE, HEA, HEB etc.)

CE

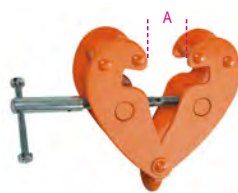

Características técnicas:  
• Fator de segurança: 4  
• Etiqueta de identificação

Certificados disponíveis:  
• Certificado do Fabricante  
• Declaração de Conformidade CE  
• Relatório de teste UNI EN10204 tipo 2.2  
• Especificações técnicas do produto

WLL t	A min mm	A max mm	€	📄	📄
1,0	90	180	123,00	1	081470210
2,0	90	190	148,00	1	081470220
3,0	85	280	250,00	1	081470230
5,0	85	280	365,00	1	081470250



## 8148

guincho manual, corpo em liga de alumínio, completo com alavanca de trabalho, corda e gancho

Leve e portátil, o guincho manual Robur está em conformidade com a norma EN 13157, é fabricado com materiais de alta qualidade e é adequado para elevar, içar, tensionar e fixar cargas em todas as direções através da alavanca.

Habitualmente ligado a um ponto amarração, permite um posicionamento muito preciso da carga e garante um trabalho seguro na horizontal, vertical e com inclinação. Fácil instalação e utilização graças ao seu design compacto e prático.

O guincho manual Robur manual possibilita a utilização de cordas de qualquer comprimento e a sua capacidade pode ser aumentada por um fator de 2, 3, 4 ou mais – mediante inspeção da sua estrutura e utilizando rolos de condução e ganchos com blocos em conformidade com a norma de referência.

CE

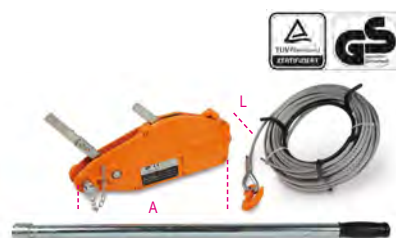

EN 13157

• Fator de segurança: 4:1

WLL t	L m	A mm	øf mm	€	📄	📄
0,8	20	426	8,3	414,00	1	081480008
1,6	20	545	11	650,00	1	081480016
3,2	20	660	16	1.070,00	1	081480032

0,8	30	426	8,3	460,00	1	081480108
1,6	30	545	11	720,00	1	081480116
3,2	30	660	16	1.200,00	1	081480132

0,8	50	426	8,3	560,00	1	081480308
1,6	50	545	11	835,00	1	081480316
3,2	50	660	16	1.450,00	1	081480332

## 8148F

cabo em aço galvanizado com cruzeta com gancho de elevada resistência

CE



WLL t	L m	øF	€	📄	📄
0,8	20	8,3	113,00	1	081480520
1,6	20	11	178,00	1	081480521
3,2	20	16	346,00	1	081480523

0,8	30	8,3	160,00	1	081480530
1,6	30	11	250,00	1	081480531
3,2	30	16	478,00	1	081480533

0,8	50	8,3	255,00	1	081480550
1,6	50	11	363,00	1	081480551
3,2	50	16	735,00	1	081480553

## 8120

correntes de elevação para ligações estáticas, galvanizadas



### CARACTERÍSTICAS TÉCNICAS

• fator de segurança: 4

### CERTIFICADOS DISPONÍVEIS

• Especificações técnicas

• Relatório de ensaio UNI EN10204 tipo 2.2

Ø mm	nr	WFL kg	m	€		
1,5	10	8	150	215,00	1	081200015
1,6	12	15	150	224,00	1	081200016
2,2	14	25	75	131,00	1	081200022
2,7	16	40	75	162,00	1	081200027
3,0	17	55	75	179,00	1	081200030
3,4	18	100	60	183,00	1	081200034
3,8	19	110	50	177,00	1	081200038
4,4	20	200	40	163,00	1	081200044
4,8	21	250	30	156,00	1	081200048
5,5	22	300	25	156,00	1	081200055
5,8	23	310	25	177,00	1	081200058
6,5	24	400	25	200,00	1	081200065
7,0	25	450	25	244,00	1	081200070
7,5	26	550	20	217,00	1	081200075
* 8,0	27	600	25	314,00	1	081200080
* 9,0	28	800	25	395,00	1	081200090
* 10,0	30	1000	20	399,00	1	081200100
* 12,0	32	1400	15	423,00	1	081200120

Atenção: produto NÃO concebido para elevação

(\*) disponível em ROLOS

## 8120B

Correntes de elevação para ligações estáticas, galvanizadas



### CARACTERÍSTICAS TÉCNICAS

• fator de segurança: 4

### CERTIFICADOS DISPONÍVEIS

• Especificações técnicas

• Relatório de ensaio UNI EN10204 tipo 2.2

Ø mm	nr	WFL kg	m	€		
1,5	10	8	200	268,00	1	081200315
1,6	12	15	200	283,00	1	081200316
2,2	14	25	100	167,00	1	081200322
2,7	16	40	100	214,00	1	081200327
3,0	17	55	75	179,00	1	081200330
3,4	18	100	100	284,00	1	081200334
3,8	19	110	75	252,00	1	081200338
4,4	20	200	50	195,00	1	081200344
4,8	21	250	50	252,00	1	081200348
5,5	22	300	40	241,00	1	081200355
5,8	23	310	30	207,00	1	081200358
6,5	24	400	30	235,00	1	081200365
7,0	25	450	25	238,00	1	081200370
7,5	26	550	25	262,00	1	081200375
8,0	27	600	15	202,00	1	081200380
9,0	28	800	15	239,00	1	081200390
10,0	30	1000	10	196,00	1	081200400
12,0	32	1400	8	226,00	1	081200420

Atenção: produto NÃO concebido para elevação

## 8121MZC

corrente para uniões estáticas, galvanizada a quente



### CERTIFICADOS DISPONÍVEIS

• Especificações técnicas

• Relatório de ensaio UNI EN10204 tipo 2.2

Ø mm	nr	WFL kg	m	€		
6,0	23	310	50	385,00	1	081210306
8,0	27	600	50	660,00	1	081210308
10,0	30	1000	50	1.040,00	1	081210310
12,0	32	1400	50	1.500,00	1	081210312
14,0	34	1800	50	2.100,00	1	081210314

## 8120D

correntes calibradas DIN766

galvanização eletrolítica

disponíveis em qualquer comprimento a pedido (>30m)



### Características técnicas:

• fator de segurança: 4

### CERTIFICADOS DISPONÍVEIS

• Especificações técnicas

• Relatório de teste UNI EN10204 tipo 2.2

Ø mm	P mm	WFL kg	m	€		
4	16	200	30	135,00	1	081200640
5	18,5	320	30	190,00	1	081200650
6	18,5	400	30	287,00	1	081200660
7	22	630	30	345,00	1	081200670
8	24	800	30	456,00	1	081200680
10	28	1250	30	700,00	1	081200700

correntes calibradas DIN766

galvanização a quente

Ø mm	P mm	WFL kg	m	€		
4	16	200	30	167,00	1	081200840
5	18,5	320	30	229,00	1	081200850
6	18,5	400	30	339,00	1	081200860
7	22	630	30	398,00	1	081200870
8	24	800	30	530,00	1	081200880
10	28	1250	30	805,00	1	081200900

## 8129

corrente de barreira, em metal galvanizado pintado de vermelho e branco



Ø mm	m	€		
5	30	284,00	1	081290050

Atenção: NÃO adequada para elevar ou ancorar

## 8130

correntes antirroubo, em liga de aço, endurecidas, temperado, galvanizado



Ø mm	L mm	€		
6	800	17,20	1	081300068
8	1000	37,00	1	081300081
8	1200	42,00	1	081300082
10	1500	64,50	1	081300105

## 8074

mosquetão, zincado



DIN 5299 tipo C

### CARACTERÍSTICAS TÉCNICAS

• fator de segurança: 4

### CERTIFICADOS DISPONÍVEIS

• Especificações técnicas

• Relatório de ensaio UNI EN10204 tipo 2.2

DxL mm	A mm	WFL kg	€		
* 4x40	6	20	0,70	100	080740040
5x50	7	30	0,71	100	080740050
6x60	8	40	0,78	100	080740060
7x70	9	60	1,00	50	080740070
8x80	11	75	1,21	50	080740080
9x90	12	100	1,65	25	080740090
10x100	13	120	2,22	25	080740100
11x120	16	140	3,00	20	080740101
12x140	22	140	4,20	15	080740102
13x160	24	200	5,80	10	080740103
* 14x180	32	250	12,10	5	080740104

packs especiais



DxL mm	A mm	€			
6x60	8	50	44,00	1	080740760
7x70	9	25	28,50	1	080740770
8x80	11	25	34,00	1	080740780
9x90	12	15	28,00	1	080740790
10x100	13	15	37,50	1	080740800
11x120	16	10	34,00	1	080740801
12x140	22	10	47,50	1	080740802



## 8074A

ganchos articulados, zincado



DIN 5299 tipo A

### CARACTERÍSTICAS TÉCNICAS

- factor de segurança: 4
- CERTIFICADOS DISPONÍVEIS
- Especificações técnicas
- Relatório de ensaio UNI EN10204 tipo 2.2

øAxL mm	D mm	WFL kg	€		
5x50	7,4	30	0,96	50	080740405
6x60	8,7	40	1,10	50	080740406
8x80	10,5	75	1,50	25	080740408
10x100	13,3	120	2,65	10	080740410

## 8074G

mosquetão com porca, zincado

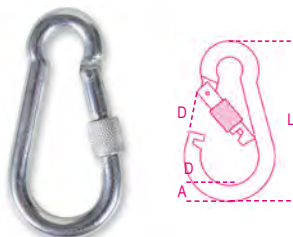

### CARACTERÍSTICAS TÉCNICAS

- factor de segurança: 4
- CERTIFICADOS DISPONÍVEIS
- Especificações técnicas
- Relatório de ensaio UNI EN10204 tipo 2.2

øAxL mm	D mm	WFL kg	€		
5x50	7,5	30	1,08	50	080740305
6x60	8,5	40	1,23	50	080740306
8x80	10,3	75	1,65	25	080740308
10x100	10,6	120	2,78	10	080740310

## 8080

elo de ligação rápida, zincado



### CARACTERÍSTICAS TÉCNICAS

- factor de segurança: 4
- CERTIFICADOS DISPONÍVEIS
- Especificações técnicas
- Relatório de ensaio UNI EN10204 tipo 2.2

DxL mm	A mm	WFL kg	€		
3,5x36	5	20	0,57	100	080800003
4x40	6	30	0,61	100	080800004
5x49	6	50	0,74	100	080800005
6x57	8	60	0,93	100	080800006
7x66	8	100	1,21	50	080800007
8x74	11	140	1,44	50	080800008
9x80	11	160	2,07	25	080800009
10x89	11	220	2,43	25	080800010
12x105	15	300	4,20	20	080800012
14x122	16,5	400	9,10	3	080800014

## 8050 D1=D45

kit substituição de travão de segurança para ganchos



	€		
<b>8050D1</b> 8064S-8065SC/800-8055S/1250	9,00	1	080500945
<b>8050D2</b> 8064S-8065SC/1000 8062/1500-8055S/1600	10,50	1	080500946
<b>8050D3</b> 8064S-8065SC/1600-2000 8055S/2500-3200	11,30	1	080500947
<b>8050D4</b> 8064S-8065SC/3200-8055S/5400	18,70	1	080500948
<b>8050D5</b> 8064S-8065SC/5000-8055S/8000	21,60	1	080500949
<b>8050D6</b> 8064S/7500-8055S/11500	34,50	1	080500950
<b>8050D11</b> 8062/2000	17,80	1	080500955
<b>8050D12</b> 8062/3000	19,70	1	080500956
<b>8050D13</b> 8062/5000	35,50	1	080500957
<b>8050D22</b> 8064S/10000 8055S/16000	47,00	1	080500966
<b>8050D23</b> 8055S/22000	65,00	1	080500967
<b>8050D24</b> 8051S/250	0,82	1	080500969
<b>8050D25</b> 8051S/500	0,97	1	080500970
<b>8050D32</b> 8060/8000	36,00	1	080500977
<b>8050D 33</b> 8052/800	3,60	1	080500978
<b>8050D 34</b> 8052/1120	4,05	1	080500979
<b>8050D 35</b> 8052/2000	4,95	1	080500980
<b>8050D 36</b> 8052/3150	5,40	1	080500981
<b>8050D 37</b> 8052/4000	6,40	1	080500982

<b>8050D38</b> 8060R/1120	2,34	1	080500983
<b>8050D53</b> 8060R/1500	3,20	1	080500994
<b>8050D39</b> 8060R/2000	3,20	1	080500984
<b>8050D40</b> 8060R/3150	5,60	1	080500985
<b>8050D41</b> 8060R/5300	8,60	1	080500986
<b>8050D42</b> 8063/800	0,82	1	080500987
<b>8050D43</b> 8063/1120	1,17	1	080500988
<b>8050D44</b> 8063/2000	1,52	1	080500989
<b>8050D45</b> 8063/3150	1,86	1	080500990



<b>8050D46</b> 8061R/1120	2,43	1	080500991
<b>8050D47</b> 8061R/2000	2,43	1	080500992
<b>8050D48</b> 8061R/3150	3,30	1	080500993
<b>8050D54</b> 8061R/5300	3,30	1	080500995
<b>8050D30</b> 8061R/8000	26,00	1	080500975



<b>8050D49</b> 8057R - 8058R - 8063SL /1120	6,80	1	080500849
<b>8050D50</b> 8057R - 8058R - 8063SL /2000	7,40	1	080500850
<b>8050D51</b> 8057R - 8058R - 8063SL /3150	8,00	1	080500851
<b>8050D52</b> 8057R - 8058R - 8063SL /5300	17,90	1	080500852

## 8058R/PS

kit de pinos para ganchos item 8058R-8061R



	Ø mm	€		
<b>8058R/PS 1,12</b>	6	7,80	1	080580512
<b>8058R/PS 2,0</b>	7-8	9,00	1	080580520
<b>8058R/PS 3,15</b>	10	17,90	1	080580532
<b>8058R/PS 5,3</b>	13	30,50	1	080580553

## 8060R/PS

kit de pinos para ganchos item 8060R



	Ø mm	€		
<b>8060R/PS 1,12</b>	6	7,80	1	080600511
<b>8060R/PS 1,5</b>	7	9,00	1	080600515
<b>8060R/PS 2,0</b>	8	9,00	1	080600520
<b>8060R/PS 3,15</b>	10	17,90	1	080600532
<b>8060R/PS 5,3</b>	13	30,50	1	080600553



## 8135/KLA1

kit alavanca de comando  
para gancho de elevação 8135



8135 t	€		
0,75	17,60	1	081350605
1,00	21,80	1	081350610
2,00	25,00	1	081350615
3,00	30,50	1	081350620
5,00	47,00	1	081350625

As reparações devem ser realizadas por pessoal qualificado.

## 8135/KM0

kit mola para gancho de elevação 8135



8135 t	€		
0,75	7,80	1	081350655
1,00	11,40	1	081350660
2,00	14,90	1	081350665
3,00	19,10	1	081350670
5,00	28,50	1	081350675

As reparações devem ser realizadas por pessoal qualificado.

## 8143/RKL

kit de fechos superior e inferior  
para diferenciais de corrente manuais 8143



8143 WLL t	€		
0,5	1,58	1	081430500
1,0	1,82	1	081430501
1,5	2,29	1	081430499
2,0	2,75	1	081430502
3,0	3,20	1	081430503
5,0	3,75	1	081430504

## 8143/RPC

kit de pinos de bloqueio  
para diferenciais de corrente manuais 8143



8143 WLL t	€		
0,5	1,90	1	081430510
1,0	2,59	1	081430511
1,5	2,62	1	081430509
2,0	2,80	1	081430512
3,0	4,60	1	081430513
5,0	4,95	1	081430514

## 8143/RPF

kit de batentes  
para diferenciais de corrente manuais 8143



8143 WLL t	€		
0,5	0,86	1	081430520
1,0	0,92	1	081430521
1,5	0,93	1	081430519
2,0	1,29	1	081430522
3,0	1,01	1	081430523
5,0	1,58	1	081430524

## 8143/RKCI

kit de ganchos inferiores  
para diferenciais de corrente manuais 8143



8143 WLL t	€		
0,5	12,30	1	081430560
1,0	16,10	1	081430561
1,5	26,00	1	081430559
2,0	30,00	1	081430562
3,0	98,50	1	081430563
5,0	136,00	1	081430564
10,0	213,00	1	081430565

## 8146/RK

fechos, pinos e batentes de segurança  
para os diferenciais de alavanca 8146C-8146



8146C-8146 WLL t	€		
0,25	6,20	1	081460902

## 8146/RKL

kit de fechos superior e inferior  
para diferenciais de alavanca 8146



8146 WLL t	€		
0,75	1,82	1	081460500
1,5	2,09	1	081460501
3,0	3,20	1	081460502
6,0	3,65	1	081460503

## 8146/RPC

kit de pinos de bloqueio  
para diferenciais de alavanca 8146



8146 WLL t	€		
0,75	1,90	1	081460510
1,5	2,80	1	081460511
3,0	2,95	1	081460512
6,0	2,95	1	081460513

## 8146/RKFC

kit de batentes  
para diferenciais de alavanca 8146



8146 WLL t	€		
0,75	5,10	1	081460520
1,5	6,50	1	081460521
3,0	6,90	1	081460522
6,0	8,10	1	081460523

## 8146/RKCI

kit de ganchos inferiores  
para diferenciais de alavanca 8146



8146 WLL t	€		
0,75	14,00	1	081460560
1,5	30,00	1	081460561
3,0	98,50	1	081460562
6,0	186,00	1	081460563

## 8147S/RKR

kit de rodas para trolley para guincho manual  
8147S



WLL t	€		
0,5	60,00	1	081470900
1,0	70,50	1	081470901
2,0	107,00	1	081470902

## 8147C/RKR

kit de rodas para trolley de corrente para guincho manual 8147C



WLL t	€	📄	📦
1,0	72,00	1	081470951
2,0	112,00	1	081470952
3,0	190,00	1	081470953
5,0	268,00	1	081470955

## 8148/RA

cruzeta para cabo de aço para guincho manual 8148



8148 t	€	📄	📦
0,8	22,30	1	081480900
1,6	30,00	1	081480901
3,2	38,50	1	081480902

## 8148/RKS

conjunto de 3 pinos contra sobrecarga para guincho manual 8148



8148 t	€	📄	📦
0,8	4,10	1	081480903
1,6 - 3,2	5,20	1	081480904

## 8148/RKCM

conjunto de 2 tampas do punho para guincho manual 8148



8148/RKCM	€ 1,86	📄 1	📦 081480905
-----------	--------	-----	-------------

## 8148/RKCL

jogo de 2 tampas de alavanca para guincho manual 8148



8148/RKCL	€ 1,98	📄 1	📦 081480906
-----------	--------	-----	-------------

## 8148/RP

pinos de ancoragem para guincho manual 8148



8148 t	€	📄	📦
0,8	17,10	1	081480907
1,6	22,90	1	081480908
3,2	29,00	1	081480909

## 8148/RKG

jogo de 2 capas de proteção para guincho manual 8148



8148 t	€	📄	📦
0,8	17,60	1	081480910
1,6	20,10	1	081480911
3,2	21,20	1	081480912

## 8149

correntes de elevação

CE

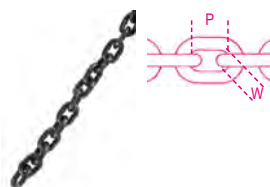

EN 818-7

### CARACTERÍSTICAS TÉCNICAS

- factor de segurança: 4
- tratamento a quente: reforçado e temperado
- código de localização

### TESTES LABORATORIAIS

- análise química
- análise metalográfica
- teste de elasticidade

### CERTIFICADOS DISPONÍVEIS

- Especificações de produto
- Relatório de Teste UNI EN10204 tipo 2.2
- Declaração de Conformidade CE

Ø mm	WLL Kg	P mm	W mm	€/m	📄	📦
4	500	12	4,8	16,80	1	081490012
5	800	15	6,0	20,80	1	081490015
6	1100	18	7,2	23,30	1	081490018
6,3	1200	19	7,6	26,00	1	081490019
8	2000	24	9,6	35,00	1	081490024
10	3200	30	12	54,00	1	081490030

## 8149CM

correntes para diferencial de corrente 8143



Ø mm	B mm	t mm	€/m	📄	📦
4,8	8,2	22,2	5,40	1	081490901

\* ATENÇÃO: O produto é entregue com um comprimento de corrente, a menos que especificado de outra forma no pedido!

## 8149CM/RA

corrente de substituição para diferencial de corrente 8143



L m	€	📄	📦
3	68,50	1	081490903
6	104,00	1	081490906

\*Anel fechado soldado. Por favor, leia o manual ativamente antes de substituir a corrente.

## 8149 CMC

correntes para trolleys 8147C



Ø mm	B mm	€/m	📄	📦
4,7	7	4,10	1	081490600

# Robur



Ao contrário do aço de utilização geral (AISI 304), o aço AISI 316 selecionado pela Beta oferece elevada resistência às intempéries, bem como à corrosão salina e à corrosão por sal e ácidos orgânicos. O aço inoxidável AISI 316 possui alto teor de:

- **Crômio** (forma uma película superficial que protege o material da oxidação)
- **Molibdênio** (aumenta a resistência à corrosão de cloretos, por exemplo, água do mar e produtos de descongelamento)
- **Níquel** (permite que a estrutura de aço se mantenha estável ao longo do tempo)

Além disso, o baixo teor de carbono torna este aço mais resistente à corrosão intergranular (um tipo particular de corrosão que dificilmente pode ser detetado na superfície do acessório e pode provocar quebras repentinas em ambientes corrosivos).

O aço AISI 316 possui algumas características adicionais: é fácil de limpar, possui excelente coeficiente higiénico, propriedades não magnéticas e bom desempenho mecânico em baixas temperaturas.

Sem dúvida, a qualidade uniforme e constante foi, e ainda é, o principal fator de fiabilidade dos produtos de aço inoxidável da Robur, pois garante que os mesmos níveis de desempenho sejam alcançados para todos os lotes de produção - ontem, hoje e amanhã.



## 8205

tensores de dois olhais  
aço inoxidável AISI 316

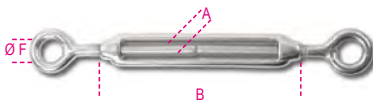

### TESTES LABORATORIAIS

- análise química
- ensaio de tracção

### CERTIFICADOS DISPONÍVEIS

- Especificações técnicas
- Relatório de ensaio UNI EN10204 tipo 2.2

A mm	B mm	ØF mm	WFL kg	€		
M4	62	8	75	6,80	10	082050204
M5	72	11	115	8,10	10	082050205
M6	92	12	160	10,70	8	082050206
M8	122	14	300	16,40	8	082050208
M10	150	16	470	24,70	4	082050210
M12	201	18	690	42,00	1	082050212
M14	225	22	940	105,00	1	082050214
M16	244	26	1290	107,00	1	082050216
M20	295	29	2130	155,00	1	082050220
M24	350	33	3000	354,00	1	082050224

### packs especiais



A mm	B mm	€		
M4	62	5	37,50	1 082050704
M5	72	5	45,50	1 082050705
M6	92	4	48,00	1 082050706
M8	122	4	74,00	1 082050708
M10	150	2	56,00	1 082050710



## 8206

tensores de olhal e gancho  
aço inoxidável AISI 316

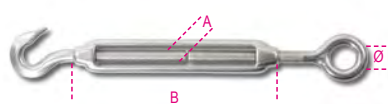

### TESTES LABORATORIAIS

- análise química
- ensaio de tracção

### CERTIFICADOS DISPONÍVEIS

- Especificações técnicas
- Relatório de ensaio UNI EN10204 tipo 2.2

A mm	B mm	ØF mm	WFL kg	€		
M5	72	11	25	8,20	10	082060205
M6	92	12	45	11,30	5	082060206
M8	122	14	95	17,20	5	082060208
M10	150	16	140	26,00	1	082060210
M12	201	18	300	43,50	1	082060212
M14	225	22	420	106,00	1	082060214
M16	244	26	570	108,00	1	082060216
M20	295	29	875	157,00	1	082060220

## 8207

tensores de dois ganchos  
aço inoxidável AISI 316

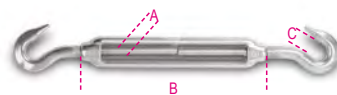

### TESTES LABORATORIAIS

- análise química
- ensaio de tracção

### CERTIFICADOS DISPONÍVEIS

- Especificações técnicas
- Relatório de ensaio UNI EN10204 tipo 2.2

A mm	B mm	C mm	WFL kg	€		
M5	72	9	25	8,70	10	082070205
M6	92	9	45	11,40	5	082070206
M8	122	10	95	17,50	5	082070208
M10	150	12	140	26,50	1	082070210
M12	201	14	300	44,00	1	082070212
M14	225	15	420	107,00	1	082070214
M16	244	16	570	111,00	1	082070216
M20	295	19	875	163,00	1	082070220

## 8209

tensores de duas forquilhas  
aço inoxidável AISI 316

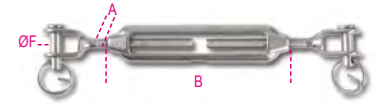

### TESTES LABORATORIAIS

- análise química
- ensaio de tracção

### CERTIFICADOS DISPONÍVEIS

- Especificações técnicas
- Relatório de ensaio UNI EN10204 tipo 2.2

A mm	B mm	ØF mm	WFL kg	€		
M5	72	5	115	14,40	5	082090205
M6	92	6	160	16,90	5	082090206
M8	122	8	300	24,40	5	082090208
M10	150	10	470	40,00	1	082090210
M12	201	12	690	64,50	1	082090212
M14	225	14	940	87,00	1	082090214
M16	244	16	1290	131,00	1	082090216
M20	295	20	2130	230,00	1	082090220
M24	350	24	3060	560,00	1	082090224

## 8210

tensores de duas forquilhas  
aço inoxidável AISI 316



### TESTES LABORATORIAIS

- análise química
- ensaio de tracção

### CERTIFICADOS DISPONÍVEIS

- Especificações técnicas
- Relatório de ensaio UNI EN10204 tipo 2.2

A mm	B mm	ØF mm	WFL kg	€		
M5	81	5	115	18,10	3	082100205
M6	92	6	160	21,80	3	082100206
M8	112	8	300	31,50	1	082100208
M10	121	10	470	49,50	1	082100210
M12	150	12	690	82,50	1	082100212
M14	169	14	940	107,00	1	082100214
M16	190	16	1290	159,00	1	082100216
M20	220	20	2130	275,00	1	082100220

## 8210FTP

tensor de forquilha com parafusos de fixação e mordente fixo em aço inox  
AISI 316

Aço com níquel, cromo e molibdênio para maior resistência à corrosão.

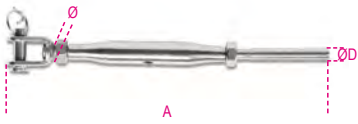

### TESTES LABORATORIAIS

- análise química
  - ensaio de tensão
- CERTIFICADOS DISPONÍVEIS**
- Especificações técnicas
  - Relatório de teste UNI EN10204 tipo 2.2

Ø mm	A mm	ØD mm	WFL mm	€	kg	Q
M5	159	2,70	150	20,20	2	082100605
M6	179	3,30	250	23,90	2	082100606
M8	216	4,30	350	32,50	1	082100608
M10	241	5,30	550	50,50	1	082100610
M12	300	6,30	1000	73,50	1	082100612
M14	345	7,30	1350	111,00	1	082100614
M16	383	8,30	1625	161,00	1	082100616
M20	484	10,50	2125	274,00	1	082100620

## 8201T

corpo para tensores  
AISI 316



### TESTES LABORATORIAIS

- análise química
  - teste elasticidade
- CERTIFICADOS DISPONÍVEIS**
- Especificações do Produto
  - Relatório de Teste UNI EN10204 tipo 2.2

Ø mm	Ø" mm	WFL kg	L mm	€	kg	Q
M6	1/4	160	95	4,05	5	082010406
M8	5/16	300	105	6,00	5	082010408
M10	3/8	470	125	10,00	3	082010410
M12	1/2	690	150	17,50	3	082010412
M14	9/16	940	165	18,60	1	082010414
M16	5/8	1290	190	31,50	1	082010416
M20	3/4	2130	210	47,50	1	082010420

## 8210F

tensores de forquilha,  
aço inox AISI 316

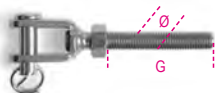

### TESTES LABORATORIAIS

- análise química
  - ensaio de tensão
- CERTIFICADOS DISPONÍVEIS**
- Especificações técnicas
  - Relatório de teste UNI EN10204 tipo 2.2

Ø mm	Ø" mm	G mm	WFL kg	€	kg	Q
M5	3/16	38,5	115	6,00	4	082100305
M6	1/4	49	160	6,80	4	082100306
M8	5/16	56	300	9,80	4	082100308
M10	3/8	61	470	16,70	2	082100310
M12	1/2	81	690	26,50	2	082100312
M14	9/16	93	940	41,50	2	082100314

## forquilhas para tensores direitos - zincadas

Ø mm	Ø" mm	G mm	WFL kg	€	kg	Q
M5	3/16	38,5	115	6,00	4	082100405
M6	1/4	49	160	6,80	4	082100406
M8	5/16	56	300	9,80	4	082100408
M10	3/8	61	470	16,70	2	082100410
M12	1/2	81	690	26,50	2	082100412
M14	9/16	93	940	42,50	2	082100414

## 8248

tirantes de olhal  
aço inoxidável 316L,  
rosca direita



UNI 6058

### CERTIFICADOS DISPONÍVEIS

- Especificações do Produto
- Relatório de Teste UNI EN10204 tipo 2.2

ØxL mm	F mm	€	kg	Q
8X120	6	7,80	1	082480008
10x80	8	10,60	1	082480010
10x130	8	14,10	1	082480012
12x95	10	16,00	1	082480016
12x125	10	19,00	1	082480018

## 8249

argolas de pressão  
aço inoxidável AISI 316

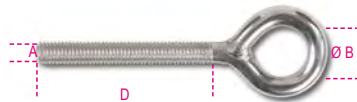

### TESTES LABORATORIAIS

- análise química
  - ensaio de tracção
- CERTIFICADOS DISPONÍVEIS**
- Especificações técnicas
  - Relatório de ensaio UNI EN10204 tipo 2.2

A mm	WFL kg	D mm	€	kg	Q
M5	100	50	2,91	10	082490205
M6	160	55	3,65	10	082490206
M8	300	60	5,90	5	082490208
M10	470	80	10,60	5	082490210
M12	690	120	18,40	2	082490212

## 8249G

ganchos de fixação  
AISI 316



### TESTES LABORATORIAIS

- análise química
  - teste elasticidade
- CERTIFICADOS DISPONÍVEIS**
- Especificações do Produto
  - Relatório de Teste UNI EN10204 tipo 2.2

A mm	E mm	ØF mm	WFL kg	€	kg	Q
M5	39	9	25	1,40	5	082490305
M6	43	10,5	45	1,67	5	082490306
M8	57	14,5	95	2,91	3	082490308

## 8216

cerra cabos  
aço inoxidável AISI 316

CE

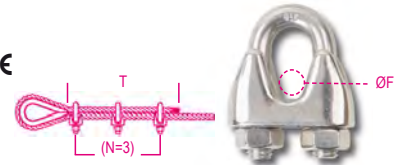

### TESTES LABORATORIAIS

- análise química
  - teste binário
- CERTIFICADOS DISPONÍVEIS**
- Especificações técnicas
  - Relatório de ensaio UNI EN10204 tipo 2.2
  - Certificado de Conformidade CE

ØF mm	"	T mm	N	€	kg	Q
2	5/64	80	3	3,40	20	082160202
3	1/8	80	3	3,45	20	082160203
4	5/32	80	3	3,85	20	082160204
5	3/16	110	3	4,35	20	082160205
6	1/4	120	5	4,90	10	082160206
8	5/16	210	5	6,50	10	082160208
10	3/8	240	5	9,10	8	082160210
12-13	1/2	300	5	12,60	5	082160213
16	5/8	335	5	18,60	5	082160216
20	3/4	540	5	23,50	5	082160220
22	7/8	595	7	37,50	3	082160222

## packs especiais



ØF mm	"	€	kg	Q	
2	5/64	10	38,00	1	082160702
3	1/8	10	38,50	1	082160703
4	5/32	10	43,50	1	082160704
5	3/16	10	49,00	1	082160705
6	1/4	5	28,00	1	082160706
8	5/16	5	36,50	1	082160708
10	3/8	4	41,00	1	082160710

## Embalagens especiais com blister



ØF mm	Q	€	kg	Q
2	4	14,30	1	082169402
3	4	14,40	1	082169403
4	4	16,20	1	082169404
5	2	9,80	1	082169405
6	2	11,10	1	082169406
8	2	14,30	1	082169408
10	2	19,30	1	082169410



# Robur

## 8220

guarda cabos  
aço inoxidável AISI 316

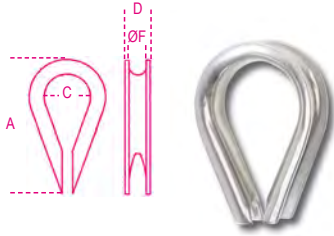

### TESTES LABORATORIAIS

- análise química

### CERTIFICADOS DISPONÍVEIS

- Especificações técnicas
- Relatório de ensaio UNI EN10204 tipo 2.2

ø F mm	D mm	A mm	C mm	€		
2	4,5	21	7,5	1,10	15	082200202
3	6	24	10	1,21	15	082200203
4	6,6	28	11	1,40	10	082200204
5	8,5	30	13	1,67	10	082200205
6	10	37	15	1,90	10	082200206
8	12,5	51	23	2,99	5	082200208
10	14,6	56	27	3,65	5	082200210
12	18	68	32	5,10	5	082200212
14	19	69	34	6,50	5	082200214
16	22	83	37	7,40	5	082200216
18	23	81	38	8,70	1	082200218
20	27,8	105	45	10,20	1	082200220
22	29,6	112	45	13,20	1	082200222

## 8225

manilhas direitas  
aço inoxidável AISI 316



### TESTES LABORATORIAIS

- análise química

### CERTIFICADOS DISPONÍVEIS

- Especificações técnicas
- Relatório de ensaio UNI EN10204 tipo 2.2

ø D mm	"	A mm	WFL kg	€		
4	5/32	8	50	3,55	20	082250204
5	3/16	11	70	3,90	20	082250205
6	1/4	13	100	4,25	10	082250206
8	5/16	17	250	7,00	10	082250208
10	3/8	21	400	10,00	8	082250210
12	1/2	25	600	16,40	3	082250212
16	5/8	32	1000	36,00	1	082250216
19	3/4	38	1600	60,00	1	082250219
22	7/8	43	2000	93,50	1	082250222
25	1	46	2800	137,00	1	082250225

### packs especiais



ø D mm	"		€		
4	5/32	10	40,00	1	082250704
5	3/16	10	44,00	1	082250705
6	1/4	5	23,90	1	082250706
8	5/16	5	38,50	1	082250708
10	3/8	4	44,50	1	082250710

## 8227

manilhas direitas, longas  
aço inoxidável AISI 316



### TESTES LABORATORIAIS

- análise química

### CERTIFICADOS DISPONÍVEIS

- Especificações técnicas
- Relatório de ensaio UNI EN10204 tipo 2.2

ø D mm	"	A mm	WFL kg	€		
4	5/32	8	50	2,99	10	082270204
5	3/16	10	70	3,45	10	082270205
6	1/4	13,5	100	4,35	5	082270206
8	5/16	17	250	7,20	5	082270208
10	3/8	21	400	11,80	2	082270210
12	1/2	25	600	18,70	1	082270212

## 8228

manilhas forma lira  
aço inoxidável AISI 316

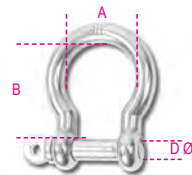

### TESTES LABORATORIAIS

- análise química

### CERTIFICADOS DISPONÍVEIS

- Especificações técnicas
- Relatório de ensaio UNI EN10204 tipo 2.2

ø D mm	A mm	B mm	WFL kg	€		
4	13	20	60	2,70	10	082280204
5	17	23	80	3,15	10	082280205
6	20	27	100	3,55	10	082280206
8	28	36	200	5,70	5	082280208
10	36	44	300	9,10	5	082280210
12	41	53	500	14,50	5	082280212
16	54	74	800	31,50	1	082280216
19	66	86	1100	58,00	1	082280219

## 8240F

argolas macho FORJADAS,  
aço inoxidável A4

CE



### CARACTERÍSTICAS TÉCNICAS

- factor de segurança: 6

- código de identificação

### TESTES LABORATORIAIS

- análise química

- análise metalográfica

- ensaio de tracção

### CERTIFICADOS DISPONÍVEIS

- Especificações técnicas

- Relatório de ensaio UNI EN10204 tipo 2.2

- Certificado de inspecção UNI EN10204 tipo 3.1

- Declaração de Conformidade CE

ø mm	WFL mm	WLL kg	€		
* M6	1,0	120	8,20	4	082400406
* M8	1,25	200	9,10	4	082400408
* M10	1,5	400	15,30	4	082400410
* M12	1,75	600	24,80	4	082400412
* M14	2	1000	40,00	2	082400414
* M16	2	1200	40,00	2	082400416
* M20	2,5	2000	64,50	2	082400420
* M24	3	2700	122,00	2	082400424
* M30	3,5	4000	270,00	1	082400430

## 8240

argolas macho  
aço inoxidável AISI 316

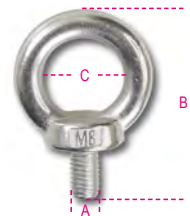

### TESTES LABORATORIAIS

- análise química

### CERTIFICADOS DISPONÍVEIS

- Especificações técnicas

- Relatório de ensaio UNI EN10204 tipo 2.2

A mm	B mm	ø C mm	WFL kg	€		
M6	41	15	90	2,33	10	082400206
M8	50	20	140	3,50	10	082400208
M10	62	25	230	7,00	5	082400210
M12	74	30	340	11,80	5	082400212

# Robur



## 8242F

argolas fêmea FORJADAS,  
aço inoxidável A4

CE



### CARACTERÍSTICAS TÉCNICAS

• factor de segurança: 6

• código de identificação

### TESTES LABORATORIAIS

• análise química

• análise metalográfica

• ensaio de tracção

### CERTIFICADOS DISPONÍVEIS

• Especificações técnicas

• Relatório de ensaio UNI EN10204 tipo 2.2

• Certificado de inspecção UNI EN10204 tipo 3.1

• Declaração de Conformidade CE

Ø	WLL	€		
mm	kg			
M6	120	8,20	4	082420406
* M8	200	9,10	4	082420408
* M10	400	15,30	4	082420410
* M12	600	24,80	4	082420412
* M14	1000	40,00	2	082420414
* M16	1200	40,00	2	082420416
* M20	2000	64,50	2	082420420
* M24	2700	122,00	2	082420424
* M30	4000	270,00	1	082420430

## 8242

argolas fêmea  
aço inoxidável AISI 316



A	B	Ø C	WFL	€		
mm	mm	mm	mm			
M6	27	15	90	2,33	10	082420206
M8	36	20	140	3,50	10	082420208
M10	45	25	230	7,00	5	082420210
M12	55	30	340	11,80	5	082420212

## 8274

mosquetão  
aço inoxidável AISI 316

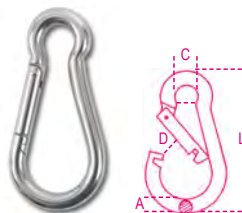

### TESTES LABORATORIAIS

• análise química

• ensaio de tracção

### CERTIFICADOS DISPONÍVEIS

• Especificações técnicas

• Relatório de ensaio UNI EN10204 tipo 2.2

Ø x L	Ø C	D	WFL	€		
mm	mm	mm	mm			
4,5x40	6,5	6	20	3,20	20	082740204
5x50	7	6,5	30	3,20	20	082740205
6x60	8,5	7,5	40	3,40	10	082740206
7x70	10	9	60	4,05	10	082740207
8x80	12	10	75	5,40	10	082740208
9x90	12,5	10,5	100	7,50	10	082740209
10x100	15	13	120	9,30	8	082740210
11x120	19	18	140	13,20	1	082740211
12x140	22	21	140	18,00	1	082740212
13x160	22	26	200	22,60	1	082740213

### packs especiais



Ø x L	Ø C	€		
mm	mm			
4,5x40	6,5	36,00	1	082740704
5x50	7	36,00	1	082740705
6x60	8,5	19,00	1	082740706
7x70	10	22,70	1	082740707
8x80	12	30,50	1	082740708
9x90	12,5	41,50	1	082740709
10x100	15	41,50	1	082740710

## 8274A

ganchos articulados  
AISI 316

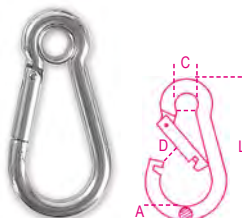

### TESTES LABORATORIAIS

• análise química

• teste elasticidade

### CERTIFICADOS DISPONÍVEIS

• Especificações do Produto

• Relatório de Teste UNI EN10204 tipo 2.2

Ø x L	Ø C	D	WFL	€		
mm	mm	mm	mm			
5x50	6,5	7	30	3,15	10	082740405
6x60	7,5	7,5	40	3,75	5	082740406
8x80	9,5	10	75	6,30	5	082740408

## 8274G

mosquetão com porca  
aço inoxidável AISI 316

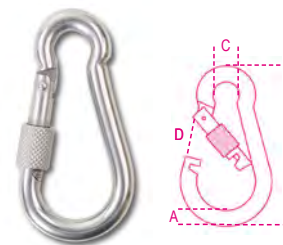

### TESTES LABORATORIAIS

• análise química

• ensaio de tracção

### CERTIFICADOS DISPONÍVEIS

• Especificações técnicas

• Relatório de ensaio UNI EN10204 tipo 2.2

Ø x L	Ø C	D	WFL	€		
mm	mm	mm	mm			
6x60	8,5	6,5	40	4,15	5	082740306
8x80	12	8,5	75	7,50	5	082740308
10x100	15	12	120	14,30	3	082740310

## 8276

mosquetão assimétrico  
aço inoxidável AISI 316

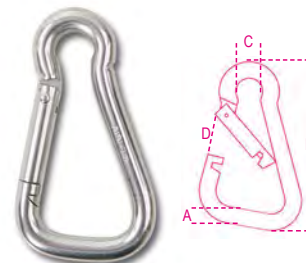

### TESTES LABORATORIAIS

• análise química

• ensaio de tracção

### CERTIFICADOS DISPONÍVEIS

• Especificações técnicas

• Relatório de ensaio UNI EN10204 tipo 2.2

Ø x L	Ø C	D	WFL	€		
mm	mm	mm	mm			
6x60	8,5	10	40	3,75	5	082760206
8x80	12	14	75	6,50	5	082760208
10x100	15	18	120	11,50	3	082760210

# Robur

# Robur

## 8276G

mosquetão assimétrico com porca  
aço inoxidável AISI 316

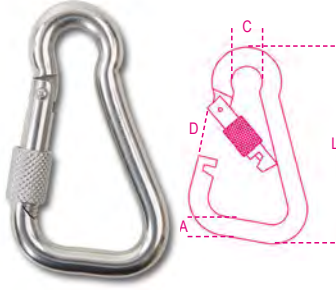

### TESTES LABORATORIAIS

- análise química
  - ensaio de tracção
- CERTIFICADOS DISPONÍVEIS**
- Especificações técnicas
  - Relatório de ensaio UNI EN10204 tipo 2.2

∅ A x L	∅ C	D	WFL	€		
mm	mm	mm	kg			
6x60	8,5	9	40	4,80	3	082760306
8x80	12	12,5	75	8,70	3	082760308
10x100	15	16	120	15,70	3	082760310

## 8278

mosquetão trapezoidal  
aço inoxidável AISI 316

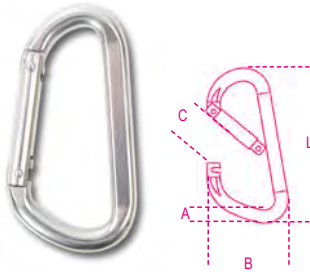

### TESTES LABORATORIAIS

- análise química
  - ensaio de tracção
- CERTIFICADOS DISPONÍVEIS**
- Especificações técnicas
  - Relatório de ensaio UNI EN10204 tipo 2.2

∅ A x L	B	C	WFL	€		
mm	mm	mm	kg			
8x80	45	14	75	14,50	3	082780208
10x100	55	16	120	22,60	3	082780210

# Robur

## 8280

elos de ligação rápida  
aço inoxidável AISI 316

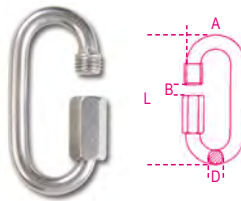

### TESTES LABORATORIAIS

- análise química
  - ensaio de tracção
- CERTIFICADOS DISPONÍVEIS**
- Especificações técnicas
  - Relatório de ensaio UNI EN10204 tipo 2.2

∅ D x L	A	B	WFL	€		
mm	mm	mm	kg			
3,5x35	17	5	20	3,70	10	082800203
4x40	19	6	30	3,90	10	082800204
5x50	23	7	50	4,80	5	082800205
6x60	26	8	60	5,70	5	082800206
7x70	30	9	100	6,50	5	082800207
8x80	33	10	140	9,20	2	082800208
10x90	40	12	220	15,00	2	082800210
12x100	47	14	300	22,60	1	082800212

## 8250

mosquetão de olhal  
aço inoxidável AISI 316



### TESTES LABORATORIAIS

- análise química
  - ensaio de tracção
- CERTIFICADOS DISPONÍVEIS**
- Especificações técnicas
  - Relatório de ensaio UNI EN10204 tipo 2.2

L	A	∅ B	WFL	€		
mm	mm	mm	kg			
50	25	8	40	4,65	5	082500205
70	31	12,5	90	7,10	5	082500207
100	47	20	190	11,50	2	082500210

## 8264

ganchos rotativos  
aço inoxidável AISI 316

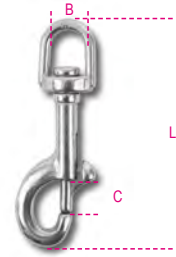

### TESTES LABORATORIAIS

- análise química
  - ensaio de tracção
- CERTIFICADOS DISPONÍVEIS**
- Especificações técnicas
  - Relatório de ensaio UNI EN10204 tipo 2.2

B	L	C	WFL	€		
mm	mm	mm	kg			
12	88	12	60	12,50	5	082640212
16	90	12	60	12,90	5	082640216
19	93	12	60	13,00	2	082640219

## 8267

mosquetão de olhal rotativo  
aço inoxidável AISI 316



### TESTES LABORATORIAIS

- análise química
  - ensaio de tracção
- CERTIFICADOS DISPONÍVEIS**
- Especificações técnicas
  - Relatório de ensaio UNI EN10204 tipo 2.2

A	L	B	WFL	€		
mm	mm	mm	kg			
10	87	21	30	11,10	5	082670210
12	118	22	70	18,50	2	082670213

# Robur

# Robur

## 8272

elos de ligação rotativos  
aço inoxidável AISI 316

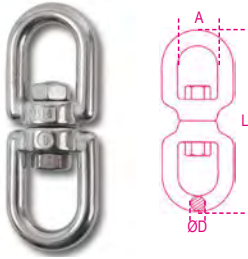

### TESTES LABORATORIAIS

- análise química
  - ensaio de tracção
- CERTIFICADOS DISPONÍVEIS**
- Especificações técnicas
  - Relatório de ensaio UNI EN10204 tipo 2.2

Ø D mm	A mm	L mm	WFL kg	€		
4	11	50	90	6,30	5	082720204
5	13	60	115	8,20	5	082720205
6	15	66	140	10,10	5	082720206
8	19	90	250	16,20	3	082720208
10	23	112	300	24,90	1	082720210
13	33	148	650	50,50	1	082720213
16	38	184	1000	94,00	1	082720216
19	40	223	1600	168,00	1	082720219

## 8273

gancho desengate rápido  
com olhal rotativo  
aço inox AISI 316

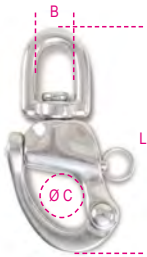

### TESTES LABORATORIAIS

- análise química
  - ensaio de tracção
- CERTIFICADOS DISPONÍVEIS**
- Especificações técnicas
  - Relatório de ensaio UNI EN10204 tipo 2.2

Ø C x L mm	B mm	WFL kg	BF kg	€		
12x70	12	230	1100	19,00	1	082730012
16x85	14,50	440	2000	26,50	1	082730016
22x120	20	700	3500	41,50	1	082730022

## 8282S

Ganchos tipo "S", aço inox AISI 316

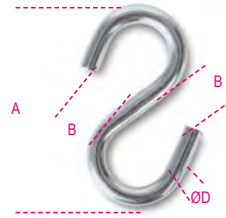

### TESTES LABORATORIAIS

- Análise química
  - Ensaio de tracção
- CERTIFICADOS DISPONÍVEIS**
- Especificações técnicas
  - Relatório de ensaio UNI EN10204 tipo 2.2

Ø D mm	B mm	A mm	WFL kg	€		
3	5,5	34	4	0,34	40	082820303
4	7,0	40	5	0,68	30	082820304
5	9,0	46	12	1,10	20	082820305
6	10	54	18	1,83	15	082820306

## 8284

mosquetão pelicano  
aço inox AISI 316



### TESTES LABORATORIAIS

- análise química
  - ensaio de tracção
- CERTIFICADOS DISPONÍVEIS**
- Especificações técnicas
  - Relatório de ensaio UNI EN10204 tipo 2.2

Ø C mm	B mm	L mm	WFL kg	€		
6	11	73	200	18,40	3	082840006
8	14	98	300	24,80	3	082840008
10	23	143	450	51,50	1	082840010

## 8285

terminais em forquilha  
aço inoxidável AISI 316

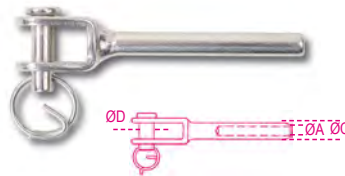

### TESTES LABORATORIAIS

- análise química
  - ensaio de tracção
- CERTIFICADOS DISPONÍVEIS**
- Especificações técnicas
  - Relatório de ensaio UNI EN10204 tipo 2.2

Ø A M	Ø C mm	Ø D mm	WFL kg	€		
3	6,3	6	180	3,65	5	082850203
4	7,5	8	200	5,90	3	082850204
5	9	10	330	8,10	2	082850205
6	12,5	12	720	16,70	2	082850206
7	12,5	12	850	17,90	2	082850207
8	15,5	16	1120	24,00	2	082850208
10	18	16	1300	34,00	2	082850210
12	20	19	2400	40,50	2	082850212

## 8286

terminais em olhal  
aço inoxidável AISI 316



### TESTES LABORATORIAIS

- análise química
  - ensaio de tracção
- CERTIFICADOS DISPONÍVEIS**
- Especificações técnicas
  - Relatório de ensaio UNI EN10204 tipo 2.2

Ø D M	Ø A mm	Ø C mm	WFL kg	€		
3	6,5	6,3	180	3,75	5	082860203
4	8,5	7,5	200	4,35	3	082860204
5	10	9	330	5,90	2	082860205
6	12,5	12,6	720	9,70	2	082860206
7	12,5	14,2	850	10,50	2	082860207
8	14,5	16	1120	17,50	2	082860208
10	16,4	18	1300	30,50	2	082860210
12	19,3	20	2400	43,50	2	082860212

## 8287

terminais em tubo  
aço inoxidável AISI 316

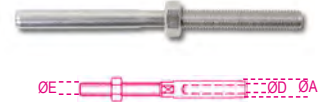

### TESTES LABORATORIAIS

- análise química
  - ensaio de tracção
- CERTIFICADOS DISPONÍVEIS**
- Especificações técnicas
  - Relatório de ensaio UNI EN10204 tipo 2.2

Ø D M	Ø A mm	E mm	WFL kg	€		
3	6,2	M6	180	3,25	5	082870203
4	7,5	M8	200	4,65	3	082870204
5	8,7	M10	330	6,50	2	082870205
6	12,6	M12	720	11,90	2	082870206
7	12,6	M14	850	16,60	2	082870207
8	16	M16	1120	24,00	2	082870208
10	18	M16	1300	26,50	2	082870210
12	20	M20	2400	36,50	2	082870212

# Robur

# Robur



## 8290

abraçadeiras para tubos  
aço inoxidável AISI 316



### TESTES LABORATORIAIS

- análise química
- CERTIFICADOS DISPONÍVEIS
- Especificações técnicas
- Relatório de ensaio UNI EN10204 tipo 2.2

Ø A	B	Ø C	L	€		
mm	mm	mm	mm			
5	18	4,3	40	1,18	5	082900205
6	22	5,2	44	1,67	5	082900206
8	23	5,2	51	2,63	5	082900208

## 8381SX

colares para sustentar tubulações

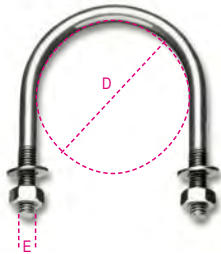

AISI 304

### TESTES LABORATORIAIS

- análise química
- CERTIFICADOS DISPONÍVEIS
- Relatório de ensaio UNIEN10204 tipo 2.2

D	D	E	€		
mm	gas	mm			
11	1/8"	M6	2,91	20	083810401
14	1/4"	M6	2,99	20	083810402
18	3/8"	M6	3,05	20	083810403
22	1/2"	M6	3,15	20	083810404
27	3/4"	M6	3,20	20	083810405
34	1"	M6	3,40	20	083810406
43	1 1/4"	M6	3,85	20	083810407
49	1 1/2"	M8	7,00	10	083810408
61	2"	M8	7,70	10	083810409
77	2 1/2"	M8	8,80	10	083810410
89	3"	M8	9,80	10	083810412
115	4"	M8	12,60	10	083810413
168	6"	M10	24,00	1	083810416
220	8"	M10	29,00	1	083810418

# Robur

## 8279

corrente para uniões estáticas,  
aço inoxidável AISI 304



### CARACTERÍSTICAS TÉCNICAS

- fator de segurança: 4
- CERTIFICADOS DISPONÍVEIS
- Especificações técnicas
- Relatório de teste UNI EN10204 tipo 2.2

Ø mm	nr	WFL	m	€		
		kg				
2	13	20	50	284,00	1	082790020
3	17	55	50	520,00	1	082790030
4	19	100	50	730,00	1	082790040
5	21	250	40	805,00	1	082790050
6	23	310	30	815,00	1	082790060
8	27	400	15	805,00	1	082790080
10	30	1000	10	1.260,00	1	082790400

## 8293

esticador com roquete AISI 304  
em poliéster muito resistente, LC 300 kg,  
com ganchos

possibilidade de suspensão

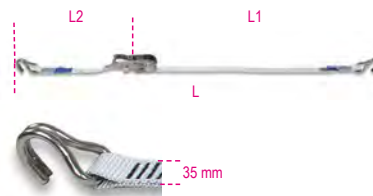

L	L2	L1	STF	€		
m	mm	mm	daN			
6	5700	300	100	81,50	1	082930106

LC = 300 kg

## 8297C

esticador com roquete, AISI 304  
em poliéster de elevada resistência, LC 700  
kg

possibilidade de suspensão

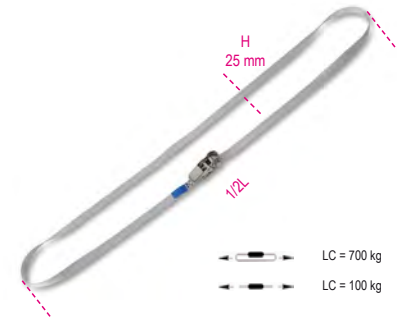

L	H	€		
m	mm			
5	25	31,00	1	082970350

## 8297F

2 cintas de fivela,  
AISI 304,  
em poliéster de elevada resistência, LC 250  
kg

possibilidade de suspensão

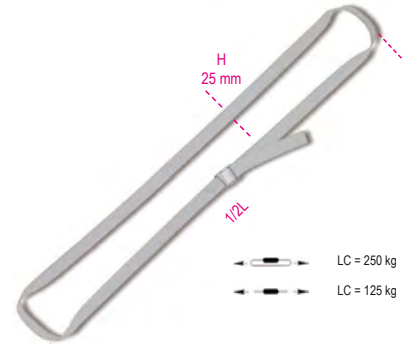

L	H	€		
m	mm			
3	25	31,00	1	082970230

LC = 250 kg

# Robur

# Robur

## ESLINGA EM POLYESTER

Fator Segurança: 7:1  
Certificado de Fábrica  
(UNI EM 1492)

### CARACTERÍSTICAS TÉCNICAS

- fator de segurança: 7
- código de identificação

### TESTES LABORATORIAIS

- ensaio de tracção

### CERTIFICADOS DISPONÍVEIS

- Especificações técnicas
- Relatório de ensaio UNI EN10204 tipo 2.2
- Certificado do fabricante UNI EN1492
- Declaração de Conformidade CE

## ESTROPOS EM POLIÉSTER

Os estropos em poliéster, em conformidade com a norma europeia UNI EN 1492, destacam-se por serem **leves, práticos e flexíveis**; não danificam as superfícies das cargas e garantem elasticidade, para que a tração sejam controlada e amortecida durante o manuseamento das cargas.

Representam uma solução ideal para **problemas de elevação com cargas delicadas**, que podem ser danificadas por lingas de cabos ou correntes, quando se trabalha em ambientes corrosivos ou em caso de perigo de condução elétrica.

A etiqueta cosida ao estropo, com os dados do fabricante, a marcação CE, o número de lote e capacidade de carga, está coberta por uma camada protetora, para que a legibilidade possa ser preservada ao longo do tempo.



	$\beta = 0^\circ$	$\beta = +45^\circ$	$\beta = 45^\circ$	$\beta = +60^\circ$	
	1t	0,8t	2t	1,4t	1t
	2t	1,6t	4t	2,8t	2t
	3t	2,4t	6t	4,2t	3t
	4t	3,2t	8t	5,6t	4t
	5t	4t	10t	7t	5t
	6t	4,8t	12t	8,4t	6t
	8t	6,4t	16t	11,2t	8t
	10t	8t	20t	14t	10t
	12t	9,6t	24t	16,8t	12t
	15t	12t	30t	21t	15t
	20t	16t	40t	28t	20t
	25t	20t	50t	35t	25t
	30t	24t	60t	42t	30t
	40t	32t	80t	56t	40t
	50t	40t	100t	70t	50t

## 8150

estropos de elevação, roxo, 1t,  
tecido duplo com olhais reforçados,  
cinta em poliéster de elevada resistência  
(PES)

CE



EN 1492-1

L m	H mm	WLL ton	€		
0,5	30	1	5,20	1	081500005
1	30	1	6,60	1	081500010
1,5	30	1	8,40	1	081500015
2	30	1	9,30	1	081500020
2,5	30	1	10,70	1	081500025
3	30	1	11,80	1	081500030
3,5	30	1	13,10	1	081500035
4	30	1	15,20	1	081500040
5	30	1	17,90	1	081500050
6	30	1	20,50	1	081500060
8	30	1	27,00	1	081500080

## 8153

estropos de elevação, verde, 2t,  
tecido duplo com olhais reforçados,  
cinta em poliéster de elevada resistência  
(PES)

CE

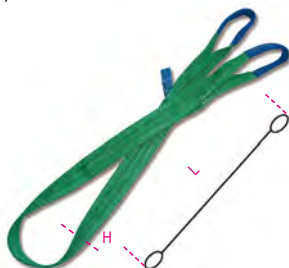

EN 1492-1

L m	H mm	WLL ton	€		
1	60	2	10,40	1	081530010
1,5	60	2	13,90	1	081530015
2	60	2	16,00	1	081530020
2,5	60	2	18,80	1	081530025
3	60	2	21,70	1	081530030
3,5	60	2	25,50	1	081530035
4	60	2	27,00	1	081530040
5	60	2	32,50	1	081530050
6	60	2	38,50	1	081530060
8	60	2	49,00	1	081530080
10	60	2	59,50	1	081530100



## 8156

estropos de elevação, amarelo, 3t  
tecido duplo com olhais reforçados,  
cinta em poliéster de elevada resistência  
(PES)

CE



EN 1492-1

L m	H mm	WLL ton	€		
1	90	3	14,70	1	081560010
1,5	90	3	19,30	1	081560015
2	90	3	23,90	1	081560020
2,5	90	3	28,50	1	081560025
3	90	3	33,50	1	081560030
3,5	90	3	37,00	1	081560035
4	90	3	41,00	1	081560040
5	90	3	49,50	1	081560050
6	90	3	58,00	1	081560060
8	90	3	76,00	1	081560080
10	90	3	93,00	1	081560100
12	90	3	117,00	1	081560120

## 8157

estropos de elevação, cinzento, 4t  
tecido duplo com olhais reforçados,  
cinta em poliéster de elevada resistência  
(PES)

CE

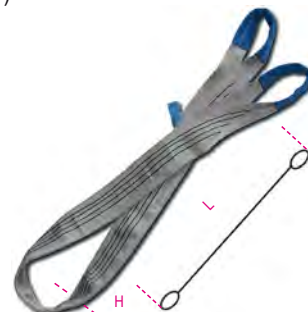

EN 1492-1

L m	H mm	WLL ton	€		
2	120	4	32,50	1	081570020
3	120	4	43,50	1	081570030
4	120	4	56,50	1	081570040
5	120	4	68,50	1	081570050
6	120	4	79,50	1	081570060
8	120	4	103,00	1	081570080
10	120	4	126,00	1	081570100
12	120	4	185,00	1	081570120





## 8158

estopros de elevação, vermelho, 5t tecido duplo com olhais reforçados, cinta em poliéster de elevada resistência (PES)

CE



EN 1492-1

L m	H mm	WLL ton	€	🚚	📄
2	150	5	45,50	1	081580020
3	150	5	59,50	1	081580030
4	150	5	76,00	1	081580040
5	150	5	91,50	1	081580050
6	150	5	108,00	1	081580060
8	150	5	139,00	1	081580080
10	150	5	171,00	1	081580100
12	150	5	250,00	1	081580120

## 8159

estopros de elevação, castanho, 6t tecido duplo com olhais reforçados, cinta em poliéster de elevada resistência (PES)

CE



EN 1492-1

L m	H mm	WLL ton	€	🚚	📄
2	180	6	56,50	1	081590020
3	180	6	83,00	1	081590030
4	180	6	107,00	1	081590040
5	180	6	129,00	1	081590050
6	180	6	150,00	1	081590060
8	180	6	196,00	1	081590080
10	180	6	242,00	1	081590100



## 8160

estopros de elevação, azul, 8t tecido duplo com olhais reforçados, cinta em poliéster de elevada resistência (PES)

CE



EN 1492-1

L m	H mm	WLL ton	€	🚚	📄
3	240	8	114,00	1	081600030
4	240	8	145,00	1	081600040
5	240	8	173,00	1	081600050
6	240	8	205,00	1	081600060
8	240	8	263,00	1	081600080
10	240	8	327,00	1	081600100

## 8161

estopros de elevação, laranja, 10t tecido duplo, 20t tecido quatro camadas, olhais reforçados

CE

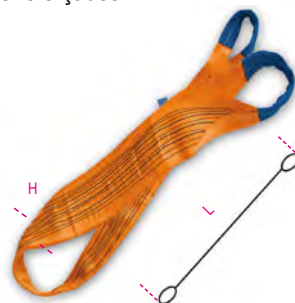

EN 1492-1

L m	H mm	WLL ton	€	🚚	📄
3	300	10	157,00	1	081610030
4	300	10	231,00	1	081610040
5	300	10	277,00	1	081610050
6	300	10	322,00	1	081610060
8	300	10	426,00	1	081610080
10	300	10	520,00	1	081610100
12	300	10	625,00	1	081610120
3	300	20	515,00	1	081612030
4	300	20	645,00	1	081612040
5	300	20	775,00	1	081612050
6	300	20	910,00	1	081612060
8	300	20	1.170,00	1	081612080
10	300	20	1.430,00	1	081612100
12	300	20	1.700,00	1	081612120

## 8170

estopros redondos, roxo, 1t cinta em poliéster de elevada resistência (PES)

CE



EN 1492-2

L m	WLL ton	H mm	€	🚚	📄
0,5	1	45	5,90	1	081700010
1	1	45	7,70	1	081700020
1,5	1	45	10,90	1	081700030
2	1	45	14,20	1	081700040
2,5	1	45	17,50	1	081700050
3	1	45	20,50	1	081700060
4	1	45	27,00	1	081700080
5	1	45	34,00	1	081700100

## 8173

estopros redondos, verde, 2t cinta em poliéster de elevada resistência (PES)

CE



EN 1492-2

L m	H mm	WLL ton	€	🚚	📄
0,5	50	2	7,70	1	081730010
1	50	2	11,80	1	081730020
1,5	50	2	17,20	1	081730030
2	50	2	22,50	1	081730040
2,5	50	2	28,00	1	081730050
3	50	2	32,50	1	081730060
4	50	2	44,00	1	081730080
5	50	2	55,50	1	081730100
6	50	2	66,00	1	081730120
8	50	2	86,50	1	081730160







**8176**

estropos redondos, amarelo, 3t  
cinta em poliéster de elevada resistência  
(PES)

CE



EN 1492-2

L m	H mm	WLL ton	€	📏	📦
0,5	60	3	8,60	1	081760010
1	60	3	15,50	1	081760020
1,5	60	3	22,50	1	081760030
2	60	3	29,00	1	081760040
2,5	60	3	36,00	1	081760050
3	60	3	43,50	1	081760060
4	60	3	58,00	1	081760080
5	60	3	72,50	1	081760100
6	60	3	87,50	1	081760120
8	60	3	115,00	1	081760160

**8177**

estropos redondos, cinzento, 4t  
cinta em poliéster de elevada resistência  
(PES)

CE



EN 1492-2

L m	H mm	WLL ton	€	📏	📦
0,5	65	4	17,10	1	081770010
1	65	4	18,40	1	081770020
1,5	65	4	27,00	1	081770030
2	65	4	35,50	1	081770040
2,5	65	4	44,50	1	081770050
3	65	4	53,50	1	081770060
4	65	4	70,00	1	081770080
5	65	4	87,50	1	081770100
6	65	4	105,00	1	081770120
8	65	4	139,00	1	081770160

**8178**

estropos redondos, vermelho, 5t  
cinta em poliéster de elevada resistência  
(PES)

CE

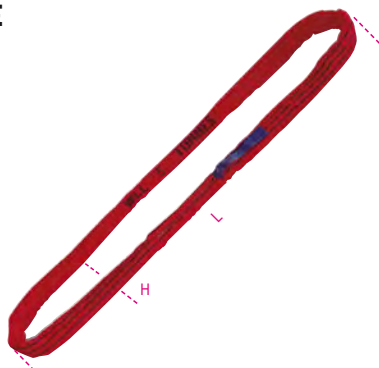

EN 1492-2

L m	H mm	WLL ton	€	📏	📦
0,5	70	5	22,80	1	081780010
1	70	5	27,00	1	081780020
1,5	70	5	34,00	1	081780030
2	70	5	44,50	1	081780040
2,5	70	5	54,50	1	081780050
3	70	5	65,00	1	081780060
4	70	5	86,50	1	081780080
5	70	5	108,00	1	081780100
6	70	5	129,00	1	081780120
8	70	5	173,00	1	081780160

**8179M**

estropos redondos, castanho, 6t  
cinta em poliéster de elevada resistência  
(PES)

CE

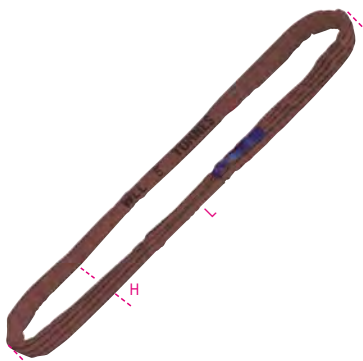

EN 1492-2

L m	H mm	WLL ton	€	📏	📦
1	80	6	29,00	1	081790020
1,5	80	6	42,00	1	081790030
2	80	6	55,50	1	081790040
2,5	80	6	68,50	1	081790050
3	80	6	80,00	1	081790060
4	80	6	107,00	1	081790080
5	80	6	135,00	1	081790100
6	80	6	160,00	1	081790120
8	80	6	213,00	1	081790160

**8179B**

estropos redondos, azul, 8 t,  
em poliéster de elevada tenacidade (PES)

CE

EN 1492-2

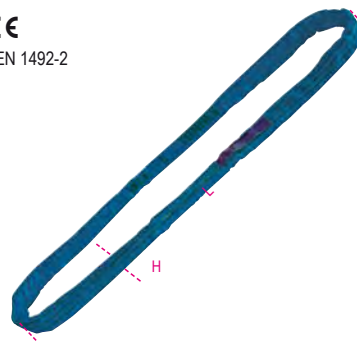

L m	H mm	WLL ton	€	📏	📦
1	85	8	36,50	1	081790220
1,5	85	8	55,50	1	081790230
2	85	8	74,00	1	081790240
2,5	85	8	91,50	1	081790250
3	85	8	106,00	1	081790260
4	85	8	141,00	1	081790280
5	85	8	181,00	1	081790300
6	85	8	212,00	1	081790320
8	85	8	282,00	1	081790360



## 8179A

estropos redondos, laranja, 10t±50t,, em poliéster de elevada tenacidade (PES)

CE  
EN 1492-2



L m	H mm	WLL ton	€		
1	95	10	55,50	1	081790502
1,5	95	10	76,00	1	081790503
2	95	10	108,00	1	081790504
2,5	95	10	126,00	1	081790505
3	95	10	166,00	1	081790506
4	95	10	216,00	1	081790508
5	95	10	242,00	1	081790510
6	95	10	321,00	1	081790512
8	95	10	393,00	1	081790516
10	95	10	540,00	1	081790520
12	95	10	575,00	1	081790524
<hr/>					
2	100	12	185,00	1	081791204
2,5	100	12	218,00	1	081791205
3	100	12	252,00	1	081791206
3,5	100	12	284,00	1	081791207
4	100	12	319,00	1	081791208
4,5	100	12	322,00	1	081791209
5	100	12	385,00	1	081791210
5,5	100	12	419,00	1	081791211
6	100	12	452,00	1	081791212
6,5	100	12	486,00	1	081791213
7	100	12	520,00	1	081791214
7,5	100	12	555,00	1	081791215
8	100	12	585,00	1	081791216
8,5	100	12	620,00	1	081791217
9	100	12	655,00	1	081791218
9,5	100	12	690,00	1	081791219
10	100	12	720,00	1	081791220
<hr/>					
2	110	15	229,00	1	081791504
2,5	110	15	268,00	1	081791505
3	110	15	305,00	1	081791506
3,5	110	15	345,00	1	081791507
4	110	15	383,00	1	081791508
4,5	110	15	420,00	1	081791509
5	110	15	458,00	1	081791510
5,5	110	15	499,00	1	081791511
6	110	15	540,00	1	081791512
6,5	110	15	575,00	1	081791513
7	110	15	615,00	1	081791514
7,5	110	15	650,00	1	081791515
8	110	15	690,00	1	081791516
8,5	110	15	730,00	1	081791517
9	110	15	770,00	1	081791518
9,5	110	15	815,00	1	081791519
10	110	15	845,00	1	081791520
<hr/>					
2	130	20	269,00	1	081792004
2,5	130	20	316,00	1	081792005
3	130	20	362,00	1	081792006
3,5	130	20	408,00	1	081792007
4	130	20	456,00	1	081792008
4,5	130	20	505,00	1	081792009
5	130	20	550,00	1	081792010
5,5	130	20	600,00	1	081792011
6	130	20	645,00	1	081792012
6,5	130	20	690,00	1	081792013
7	130	20	735,00	1	081792014
7,5	130	20	785,00	1	081792015
8	130	20	830,00	1	081792016
8,5	130	20	880,00	1	081792017
9	130	20	925,00	1	081792018
9,5	130	20	970,00	1	081792019
10	130	20	1.020,00	1	081792020

2	135	25	298,00	1	081792504
2,5	135	25	356,00	1	081792505
3	135	25	415,00	1	081792506
3,5	135	25	471,00	1	081792507
4	135	25	535,00	1	081792508
4,5	135	25	590,00	1	081792509
5	135	25	650,00	1	081792510
5,5	135	25	710,00	1	081792511
6	135	25	765,00	1	081792512
6,5	135	25	825,00	1	081792513
7	135	25	885,00	1	081792514
7,5	135	25	940,00	1	081792515
8	135	25	1.000,00	1	081792516
8,5	135	25	1.060,00	1	081792517
9	135	25	1.120,00	1	081792518
9,5	135	25	1.180,00	1	081792519
10	135	25	1.240,00	1	081792520

2	160	30	349,00	1	081793004
2,5	160	30	420,00	1	081793005
3	160	30	492,00	1	081793006
3,5	160	30	565,00	1	081793007
4	160	30	635,00	1	081793008
4,5	160	30	710,00	1	081793009
5	160	30	780,00	1	081793010
5,5	160	30	850,00	1	081793011
6	160	30	920,00	1	081793012
6,5	160	30	990,00	1	081793013
7	160	30	1.060,00	1	081793014
7,5	160	30	1.140,00	1	081793015
8	160	30	1.210,00	1	081793016
8,5	160	30	1.280,00	1	081793017
9	160	30	1.350,00	1	081793018
9,5	160	30	1.420,00	1	081793019
10	160	30	1.490,00	1	081793020

2	165	40	486,00	1	081794004
2,5	165	40	545,00	1	081794005
3	165	40	635,00	1	081794006
3,5	165	40	720,00	1	081794007
4	165	40	810,00	1	081794008
4,5	165	40	900,00	1	081794009
5	165	40	990,00	1	081794010
5,5	165	40	1.080,00	1	081794011
6	165	40	1.170,00	1	081794012
6,5	165	40	1.260,00	1	081794013
7	165	40	1.350,00	1	081794014
7,5	165	40	1.440,00	1	081794015
8	165	40	1.520,00	1	081794016
8,5	165	40	1.620,00	1	081794017
9	165	40	1.710,00	1	081794018
9,5	165	40	1.790,00	1	081794019
10	165	40	1.880,00	1	081794020

3	180	50	735,00	1	081795006
3,5	180	50	835,00	1	081795007
4	180	50	940,00	1	081795008
4,5	180	50	1.040,00	1	081795009
5	180	50	1.140,00	1	081795010
5,5	180	50	1.240,00	1	081795011
6	180	50	1.350,00	1	081795012
6,5	180	50	1.450,00	1	081795013
7	180	50	1.550,00	1	081795014
7,5	180	50	1.650,00	1	081795015
8	180	50	1.750,00	1	081795016
8,5	180	50	1.850,00	1	081795017
9	180	50	1.950,00	1	081795018
9,5	180	50	2.050,00	1	081795019
10	180	50	2.150,00	1	081795020

## 8166

revestimento anti-abrasão para estropo, poliéster de elevada resistência (PES), com camada interior elastômero



H mm	ø mm	L m	€		
70	45	3	23,70	1	081660073
80	52	3	28,00	1	081660083
110	70	3	34,00	1	081660103
155	100	3	71,00	1	081660153
170	110	3	78,00	1	081660170
235	150	4	213,00	1	081660235

H mm			
70	8150	8170-8173	081660073
80	8153	8176	081660083
110	8153-8156	8177-8178	081660103
155	8157	8178-8179A 8179B-8179M	081660153
170	8158	-	081660170
235	8159	-	081660235

## 8090F

elos para estropos em poliéster, liga de aço de elevada resistência

CE

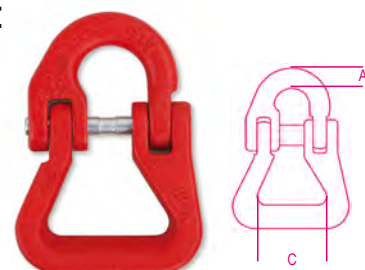

EN 1677-1

### CARACTERÍSTICAS TÉCNICAS

- fator de segurança: 4
- tratamento térmico: endurecido e temperado
- código de identificação

### TESTES LABORATORIAIS

- análise química, análise metalográfica
- ensaio de carga (WLL x 2.5)
- ensaio de tracção
- teste de fadiga (min. 20.000 ciclos)

### CERTIFICADOS DISPONÍVEIS

- Especificações técnicas
- Relatório de ensaio UNI EN10204 tipo 2.2
- Certificado de inspeção UNI EN10204 tipo 3.1
- Declaração de Conformidade CE

WLL kg	Ø mm	A mm	C mm	€		
2000	7-8	10,5	40	29,00	1	080900220
3150	10	12	50	36,50	1	080900232
5300	13	17	60	56,00	1	080900253
8000	16	21	75	86,00	1	080900280



## ESTICADOR COM SISTEMA DE ROQUETE

coeficiente 2:1

em conformidade com UNI EN 12195

CARACTERÍSTICAS TÉCNICAS

- factor de segurança: 2
- código de identificação
- TESTES LABORATORIAIS
- teste pré-tensionamento do roquete
- teste de deformação de componentes metálicos
- ensaio de tracção sistema completo
- CERTIFICADOS DISPONÍVEIS
- Especificações técnicas
- Relatório de ensaio UNI EN10204 tipo 2.2

## 8180

esticador com clique e gancho

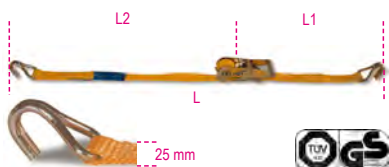

EN 12195-2

L m	L2 mm	L1 mm	STF daN	€		
4	3750	250	200	13,90	1	081800004
6	5750	250	200	16,10	1	081800006
8	7750	250	200	18,00	1	081800008

LC = 750 kg

## 8181

esticador com clique e gancho

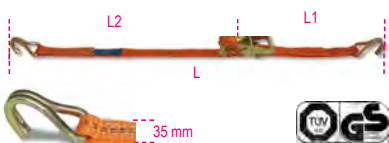

EN 12195-2

L m	L2 mm	L1 mm	STF daN	€		
4	3600	400	180	17,10	1	081810004
6	5600	400	180	19,50	1	081810006
8	7600	400	180	21,30	1	081810008

LC = 1000 kg

## 8181 6/B4

jogo de 4 esticadores com clique e gancho 8181, 6 m

poliéster de alta resistência (PES), ganchos simples



EN12195-2

L2 mm	L1 mm	L m	STF daN	€		
5600	400	6	180	81,50	3	081810916

## 8182T

Esticador com clique e 2 ganchos, LC 1500kg, cinta em poliéster de alta resistência (PES)

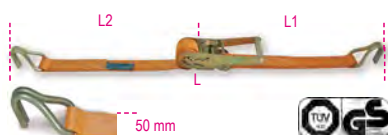

EN 12195-2

L m	L2 mm	L1 mm	STF daN	€		
8,5	8100	400	300	30,00	1	081821085
10,5	10100	400	300	32,50	1	081821105

LC = 1500 kg

## 8182

esticador com clique e gancho

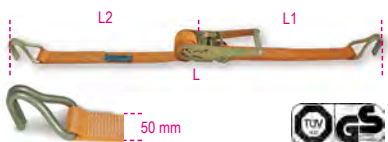

EN 12195-2

L m	L2 mm	L1 mm	STF daN	€		
4,5	4100	400	300	27,00	1	081820045
6,5	6100	400	300	31,50	1	081820065
8,5	8100	400	300	34,50	1	081820085
10,5	10100	400	300	39,50	1	081820105
14,5	14100	400	300	44,00	1	081820145
16,5	16100	400	300	51,00	1	081820165

LC = 2000 kg

## > 8182LP 8100



L2 mm	€		
8100	18,90	1	081820902

componente longo

## > 8182SP 400



L1 mm	€		
400	19,50	1	081820905

componente curto

## > 8182SP/BHN



L1 mm	€		
400	7,10	1	081820906

parte curta com um gancho e porca

## 8182 8,5/B2

jogo de 2 esticadores com clique e gancho 8182, 8.5 m

poliéster de alta resistência (PES), ganchos simples



EN 12195-2

L2 mm	L1 mm	L m	STF daN	€		
8100	400	8,5	300	72,00	4	081821885

## 8182H

Esticador com clique e gancho, LC 2000kg, cinta em poliéster de alta resistência (PES)

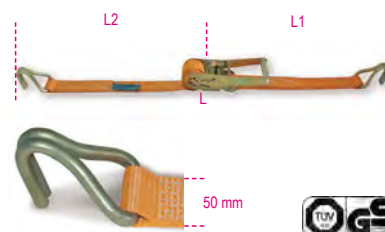

EN 12195-2

L m	L2 mm	L1 mm	STF daN	€		
6,5	6100	400	300	35,00	1	081820406
8,5	8100	400	300	37,50	1	081820408
10,5	10100	400	300	41,50	1	081820410
14,5	14100	400	300	52,50	1	081820414

LC = 2500 kg

## 8184

esticador com alavanca longa, um gancho, LC 2500 kg, cinta em poliéster de alta resistência (PES)



EN12195-2

L m	L2 mm	L1 mm	STF daN	€		
6,5	6100	400	500	38,50	1	081840065
8,5	8100	400	500	40,50	1	081840085
10,5	10100	400	500	43,50	1	081840105

LC = 2500 kg





## 8183

esticador com gancho, LC 5000 kg, cinta em poliéster muito resistente (PES)



EN 12195-2

L	L2	L1	STF	€		
m	mm	mm	daN			
8,5	8000	500	500	110,00	1	081830085
12,5	12000	500	500	131,00	1	081830125

LC = 5000 kg

## 8181S

cintas de roquete com gancho duplo, LC 1000 kg, em poliéster de elevada resistência (PES)



EN 12195-2

L	L2	L1	STF	€		
m	mm	mm	daN			
6	5600	400	180	18,90	1	081810206

LC = 1000 kg

## 8182TS

Esticador com clique e gancho, LC 1500kg, cinta em poliéster de alta resistência (PES)

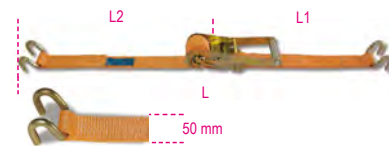

EN 12195-2

L	L2	L1	STF	€		
m	mm	mm	daN			
8,5	8100	400	300	31,00	1	081821285
10,5	10100	400	300	35,00	1	081821305

LC = 1500 kg

## 8182S

esticador com clique e 2 ganchos

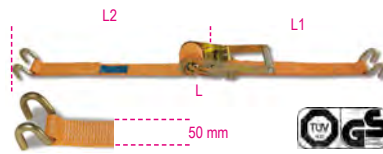

EN 12195-2

L	L1	L2	STF	€		
m	mm	mm	daN			
6,5	400	6100	300	31,00	1	081820265
8,5	400	8100	300	35,50	1	081820285
10,5	400	10100	300	39,50	1	081820305

LC = 2000 kg

## 8182SLP 8100



L2	L1	€		
mm	mm			
8100	-	18,50	1	081820912

componente longo

## 8182SSP 400



L1	€		
mm			
400	18,90	1	081820915

componente curto

## 8182SSP/BHN



L1	€		
mm			
400	6,80	1	081820916

parte curta com dois ganchos e porca

## 8182H/2

esticador com clique e 2 ganchos, LC 2500 kg, em poliéster de elevada resistência (PES)

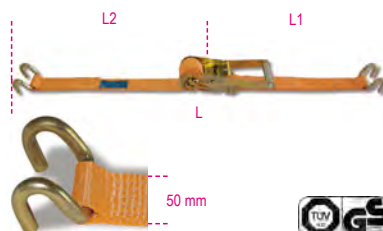

EN 12195-2

L	L1	L2	STF	€		
m	mm	mm	daN			
8,5	8100	400	300	40,00	1	081820385

LC = 2500 kg

## 8182E

esticador com clique para o interior de carrinhas e veículo pesados, LC 1000 kg, em poliéster muito resistente (PES)



EN 12195-2

L	L2	L1	STF	€		
m	mm	mm	daN			
4	3500	500	220	19,50	1	081820440

LC = 1000 kg

	L2	L1	€		
	mm	mm			
8182EL 2500	2500		6,00	1	081820942
8182EC 1500	1500		12,90	1	081820945

## 8182GD

esticador com clique e gancho delta, LC 2000 kg, em poliéster de elevada resistência (PES)



EN 12195-2

L	L2	L1	STF	€		
m	mm	mm	daN			
8,5	8100	400	300	41,00	1	081820485

LC = 2000 kg

**Robur**

**Robur**

## 8182A

cintas de roquete com 2 olhais, em poliéster de elevada resistência (PES), LC 2000 kg



EN 12195-2

L	L2	L1	STF	€	📦	📄
m	mm	mm	daN			
8,5	8100	400	300	35,50	1	081820585

LC = 2000 kg

## 8190

Tensor de correntes com roquete e 2 ganchos Grau 8



EN12195/3

### CARACTERÍSTICAS TÉCNICAS

- fator de segurança: 2
- tratamento térmico: endurecido e temperado
- código de identificação
- CERTIFICADOS DISPONÍVEIS
- Especificações técnicas
- Relatório de ensaio UNI EN10204 tipo 2.2
- Certificado de inspeção UNI EN10204 tipo 3.1

Ø mm	LC	Ø mm	LC	€	📦	📄
daN	daN	daN	daN			
10	6300	8	4000	90,50	1	081900010
13	10000	-	-	142,00	1	081900013

\* ATENÇÃO: O produto pode ser utilizado com uma corrente de 8 mm, desde que a Tensão Máxima de Utilização seja reduzida (LC 4000 daN)



## 8190B

correntes de fixação



EN12195/3

### CARACTERÍSTICAS TÉCNICAS

- fator de segurança: 2
- tratamento térmico: endurecido e temperado
- etiqueta de identificação
- CERTIFICADOS ANEXOS
- Certificado do fabricante
- CERTIFICADOS DISPONÍVEIS
- Relatório de ensaio UNI EN10204 tipo 2.2
- Especificações técnicas

Ø mm	LC	L	L1	€	📦	📄
daN	m	m				
8	4000	3,5	3,30	198,00	1	081901308
10	6300	3,5	3,28	301,00	1	081901310
13	10000	3,5	3,23	440,00	1	081901313

## 8185

esticador com clique e olhal



EN 12195-2

L	STF	€	📦	📄
m	daN			
5	200	11,50	1	081850005
8	200	13,90	1	081850008

## 8186

esticador com clique e olhal



EN 12195-2

L	STF	€	📦	📄
m	daN			
5	180	13,90	1	081860005
8	180	17,70	1	081860008

## 8187

esticador com clique e olhal



EN 12195-2

L	STF	€	📦	📄
m	daN			
5	350	25,50	1	081870005
8	350	30,00	1	081870008

## 8188C

esticador circular de aperto com sistema de roquete, LC 750 kg, correia em poliéster de elevada tenacidade (PES)



EN 12195-2

L	STF	€	📦	📄
m	daN			
1,5	72	4,60	3	081880315
2,5	72	5,50	3	081880325
5	72	6,80	3	081880350

## 8188CG/25

esticador com sistema de roquete 2 ganchos e furos,  
LC 400 kg  
correia em poliéster de elevada tenacidade (PES)



EN 12195-2

L	L1	L2	STF	€		
m	mm	mm	daN			
3	480	170	120	10,20	1	081880430
5	480	170	120	11,10	1	081880450

## 8188CU/25

esticador com sistema de roquete e ganchos,  
LC 400 kg, correia em poliéster de elevada tenacidade (PES)



EN 12195-2

L	L1	L2	€		
m	mm	mm			
5	300	4700	10,50	1	081880750



# Robur



## 8188F

esticador circular de aperto, LC 200 kg,  
correia em propileno (PP) de elevada tenacidade

- 1,5 m
- 2,0 m
- 2,5 m
- 3,0 m
- 5,0 m



EN 12195-2

L	€		
m			
1,5	2,62	10	081880215
2,0	2,81	10	081880220
2,5	3,15	10	081880225
3,0	3,30	10	081880230
5,0	4,25	6	081880250

## 8188F35

esticador circular de aperto, LC 500 kg,  
de elevada resistência, cinta em polipropileno (PP)



EN 12195-2

L	€		
m			
5	9,50	1	081880295

## 8188FG2

esticador circular de aperto com 2 ganchos e furos,  
LC 250 kg  
correia em poliéster de elevada tenacidade (PP)



EN 12195-2

L	L1	L2	€		
m	mm	mm			
3	450	110	13,60	1	081881530

## 8188/K8

kit esticadores  
com 8 acessórios



8188/K8	€		
	40,00	1	081880801

8488K	0,65m - 7kg
8488K	0,80m - 7kg
8188CL	4m - 500kg
8188FP	2,5m - 250kg

## 8189

correia em poliéster (PES)  
para esticadores



H	L	LC	€		
mm	m	kg			
25	100	750	92,50	1	081890902
35	100	1000	117,00	1	081890903
50	100	2000	187,00	1	081890905

## 8189A

tapete antiderrapante  
para fixação de cargas



L	H	S	μ	€		
m	mm	mm				
5	250	8	0,6	73,50	1	081890525

## 8189PA

2 resguardos angulares  
para cintas de poliéster

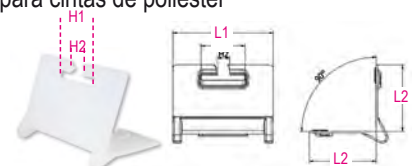

L1xL2	H1	H2	€		
mm	mm	mm			
135x90	60	18	4,60	1	081890090



Artigo	Relatório de teste 2.2 (UNI EN 10204)	Certificado de teste 3.1(UNI EN 10204)	Certificado do Fabricante	Declaração de Conformidade CE
8001Z	✓	✓		✓
8001TZ	✓	✓		✓
8002ZD	✓			
8003ZD	✓			
8004ND	✓			
8005Z	✓			✓
8005TZ	✓			✓
8006Z	✓			✓
8007Z	✓			✓
8008N	✓			✓
8008TZN	✓			✓
8009FD	✓			
8009Z	✓			✓
8009TZ	✓			✓
8010Z	✓			✓
8010TZ	✓			✓
8011Z	✓			✓
8011TZ	✓			✓
8015	✓		✓	✓
8016	✓			✓
8016DA	✓			✓
8016FR	✓			
8016U2	✓		✓	✓
8016UGK	✓		✓	✓
8018E	✓			
8018T	✓			
8020A	✓			
8021A	✓			
8025	✓	✓		✓
8026A	✓	✓		✓
8026R	✓	✓		✓
8028	✓	✓		✓
8029R	✓	✓		✓
8031R	✓	✓		✓
8032	✓	✓		✓
8040EN	✓	✓		✓
8040EZ	✓	✓		✓
8042EN	✓	✓		✓
8042EZ	✓	✓		✓
8041	✓	✓		✓
8043	✓	✓		✓
8044	✓	✓		✓
8048	✓			
8049	✓	✓		✓
8049A	✓	✓		✓
8049V	✓	✓		✓
8051S	✓	✓		✓
8052	✓	✓		✓
8057R	✓	✓		✓
8058R	✓	✓		✓
8060R	✓	✓		✓
8061R	✓	✓		✓
8062	✓	✓		✓
8063	✓	✓		✓
8063SL	✓	✓		✓
8064S	✓	✓		✓
8065SC	✓	✓		✓
8068S	✓	✓		✓
8074	✓			
8074A	✓			
8074G	✓			
8080	✓			
8080FM	✓			
8085R	✓	✓		✓
8086	✓	✓		✓
8090	✓	✓		✓

Artigo	Relatório de teste 2.2 (UNI EN 10204)	Certificado de teste 3.1(UNI EN 10204)	Certificado do Fabricante	Declaração de Conformidade CE
8090F	✓	✓		✓
8090R	✓	✓		✓
8091			✓	✓
8091SL			✓	✓
8092			✓	✓
8092SL			✓	✓
8094			✓	✓
8094SL			✓	✓
8096			✓	✓
8096SL			✓	✓
8097			✓	✓
8097SL			✓	✓
8098			✓	✓
8098SL			✓	✓
8100	✓	✓		✓
8105	✓	✓		✓
8109	✓	✓		✓
8110	✓			
8114	✓			
8116	✓			
8120 - 8120D	✓			
8120B	✓			
8121MZC	✓			
8134	✓		✓	✓
8135-H	✓		✓	✓
8143-SL	✓		✓	✓
8146-SL	✓		✓	✓
8146C	✓		✓	✓
8147C-S-P	✓		✓	✓
8148	✓		✓	✓
8149	✓		✓	✓
8150	✓		✓	✓
8153	✓		✓	✓
8156	✓		✓	✓
8157	✓		✓	✓
8158	✓		✓	✓
8159	✓		✓	✓
8160	✓		✓	✓
8161	✓		✓	✓
8166	✓			
8170	✓		✓	✓
8173	✓		✓	✓
8176	✓		✓	✓
8177	✓		✓	✓
8178	✓		✓	✓
8179M-B-A	✓		✓	✓
8180	✓			
8181	✓			
8181S	✓			
8182	✓			
8182A-GD	✓			
8182E	✓			
8182H-H2	✓			
8182M	✓			
8182S	✓			
8182T	✓			
8182T-TS	✓			
8182TS	✓			
8185	✓			
8186	✓			
8187	✓			
8188C	✓			
8188CG/25	✓			
8188CU	✓			
8188F	✓			
8188VF/35	✓			

Artigo	Relatório de teste 2.2 (UNI EN 10204)	Certificado de teste 3.1(UNI EN 10204)	Certificado do Fabricante	Declaração de Conformidade CE
8188FG2	✓			
8190	✓	✓		
8190B	✓		✓	
8302Z	✓			
8303Z	✓			
8317DZ	✓			
8317SZ	✓			
8381SL	✓			
8381SP	✓			
8383C	✓			
8383P	✓			
8515V	✓			
8515Z	✓			
8531	✓			
8532	✓			
8535	✓			
8201T	✓			
8205	✓			
8206	✓			
8207	✓			
8209	✓			
8210	✓			
8210F	✓			
8210FTP	✓			
8216	✓			✓
8220	✓			
8225	✓			
8227	✓			
8228	✓			
8240	✓			
8240F	✓	✓		✓
8242	✓			
8242F	✓	✓		✓
8248	✓			
8249	✓			
8249G	✓			
8250	✓			
8264	✓			
8267	✓			
8272	✓			
8273	✓			
8274	✓			
8274A	✓			
8274G	✓			
8276	✓			
8276G	✓			
8278	✓			
8280	✓			
8282	✓			
8282S	✓			
8284	✓			
8285	✓			
8286	✓			
8287	✓			
8290	✓			
8293	✓			
8297C	✓			
8297F	✓			
8381SX	✓			
8702...	✓	✓		
8709...	✓	✓		



# BETA COLLECTION



## Beta Collection

Uma gama de produtos exclusivos, concebidos e desenvolvidos para reafirmar o carácter da BETA, que envolve mais de 200 artigos originais e de elevado nível: artigos de desporto, vestuário técnico e uma variada gama de artigos de recreação e promocionais. Um meio ideal para acções de promoção e imprescindível para os momentos de recreação e lazer.



### 9501TL

camisola de senhora, em algodão (80%) e poliéster (20%), 320 g/m<sup>2</sup>



	€	1	095010061
S	94,00	1	095010061
M	94,00	1	095010062
L	94,00	1	095010063
XL	94,00	1	095010064

### 9503TL

T-shirt 100% algodão jersey, 160 g/m<sup>2</sup>



	€	1	095030051
S	42,50	1	095030051
M	42,50	1	095030052
L	42,50	1	095030053
XL	42,50	1	095030054
XXL	42,50	1	095030055

### 9504TL

casaco com exterior 100% poliéster, tratamento impermeável



	€	1	095040051
S	131,00	1	095040051
M	131,00	1	095040052
L	131,00	1	095040053
XL	131,00	1	095040054
XXL	131,00	1	095040055

## 9510W

camisa stretch, manga comprida, 120 g/m<sup>2</sup>, 97% algodão, 3% elastano. Branca, com logo preto. Costas com duas pregas laterais, gola semi-francesa. Botões brancos, dois botões de punho.  
Slim fit



Medida	€	Quantidade	Artigo
XS	118,00	1	095100100
S	118,00	1	095100101
M	118,00	1	095100102
L	118,00	1	095100103
XL	118,00	1	095100104
XXL	118,00	1	095100105

## 9534B0

polo com dois botões, em algodão jersey, 200 g/m<sup>2</sup>, azul com inserts cinza



Medida	€	Quantidade	Artigo
S	67,00	1	095340071
M	67,00	1	095340072
L	67,00	1	095340073
XL	67,00	1	095340074
XXL	67,00	1	095340075

## 9534W0

polo com dois botões, em algodão jersey, 200 g/m<sup>2</sup>, branco com inserts laranja



Medida	€	Quantidade	Artigo
S	67,00	1	095340031
M	67,00	1	095340032
L	67,00	1	095340033
XL	67,00	1	095340034
XXL	67,00	1	095340035

## 9572LB

t-shirt Beta-March, 100% algodão jersey, 200 g/m<sup>2</sup> laranja, com inserts pretos



Medida	€	Quantidade	Artigo
S	51,00	1	095720801
M	51,00	1	095720802
L	51,00	1	095720803
XL	51,00	1	095720804
XXL	51,00	1	095720805

## 9577R

macacão de trabalho, estilo racing, em tecido stretch, 260 g/m<sup>2</sup>, preto e laranja, com inserções refletoras e brancas

CE



Medida	€	Quantidade	Artigo
S	152,00	1	095770151
M	152,00	1	095770152
L	152,00	1	095770153
XL	152,00	1	095770154
XXL	152,00	1	095770155
XXXL	152,00	1	095770156

## 9579C

bata em poliéster/algodão



Medida	€	Quantidade	Artigo
M	67,00	1	095791002
L	67,00	1	095791003
XL	67,00	1	095791004

## 9525CM

boné camuflado, 100% poliéster, orifícios traseiros, estilo snapback



Medida	€	Quantidade	Artigo
9525CM	25,00	1	095250098

## 9525TR

boné, 50% algodão, 50% poliéster, rede atrás, estilo snapback, preto



Medida	€	Quantidade	Artigo
9525TR	25,00	1	095250011

## 9525WB

boné, 100% poliéster, com presilha de ajuste, branco



Medida	€	Quantidade	Artigo
9525WB	17,70	1	095251032





### 9543C

gola multi usos, 100% microfibras de poliéster, sem costuras



	L cm	H cm	€		
9543C	25	50	9,00	1	095430100

### 9574B

Luvas de trabalho, com punhos elásticos, reforço nos polegares e indicadores, em couro sintético sensível ao toque



	TG.	€		
M	9	39,50	1	095740102
L	10	39,50	1	095740103
XL	11	39,50	1	095740104
XXL	12	39,50	1	095740105

### 95740

Luvas de trabalho, com punhos elásticos, reforço nos polegares e indicadores, em couro sintético sensível ao toque



	TG.	€		
M	9	39,50	1	095740202
L	10	39,50	1	095740203
XL	11	39,50	1	095740204
XXL	12	39,50	1	095740205

### 9580S

óculos de sol



EN ISO 12312-1:2013+A1:2015  
UV400  
FILTER CAT. III

	€		
9580S	35,50	1	095800100

### 9593A

Relógio analógico, caixa em aço, à prova de água até 5 ATM, bracelete em silicone



	€		
9593A	295,00	1	095930050

### 9593M

relógio automático, mostrador em aço, resistente à água 5 ATM, bracelete em aço



	€		
9593M	372,00	1	095930120

### 9593W

Relógio analógico, caixa em plástico suave, aro em metal, à prova de água até 3 ATM, bracelete em silicone



	€		
9593W	65,00	1	095930150

### 9593SB

pulseira de atividade multifunções, ecrã touch, monitorização de atividade física, frequência cardíaca, pedómetro, sono, com bracelete de silicone, preta

Compatibilidade: IOS 8.2 ou mais recente/ Android 4.4 ou mais recente  
Bluetooth 4.2  
IP67



	€		
9593SB	113,00	1	095930205

### 9541BIKE

mochila em poliéster Oxford, dimensões 41x24x16 cm



	L cm	S cm	H cm	€		
9541BIKE	24	16	41	20,40	1	095410021

### 9541F

mochila revestida a poliéster/Oxford 600D, dimensões 50x33x16 cm



	L cm	S cm	H cm	€		
9541F	33	16	50	86,00	1	095410011



## 9541PC

mochila de trabalho, estilo multi-bolsos, com compartimento interior para computador, 100% poliéster

- mochila com 3 compartimentos, cada um com fecho de correr exterior à prova de água
- primeiro compartimento com bolso para PC
- pega superior acolchoada
- porta USB
- bolso lateral em rede para garrafa/guarda-chuva
- inserção para óculos na alça de ombro
- faixa peitoral ajustável



	L	S	H	€	1	095410041
	cm	cm	cm			
9541PC	34	18	52	74,50	1	095410041

## 9541S

mochila em poliéster impermeável 210D, 33x45 cm



	L	H	€	1	095410031
	cm	cm			
9541S	33	45	11,60	1	095410031

## 9544C

trolley tamanho de cabine com 4 rodas duplas, cadeado TSA, entrada USB + tomada 3.5-mm



	L	S	H	€	1	095440101
	cm	cm	cm			
9544C	40	20	55	154,00	1	095440101

## 9557J 2.0

saco revestido a poliéster/Oxford 600D, dimensões 47x28x25 cm



	L	S	H	€	1	095570020
	cm	cm	cm			
9557J 2.0	47	25	28	91,50	1	095570020

## 9539CB

capacete para ciclismo com protetor de queixo amovível - tamanhos ajustáveis



	€	1	095390010
S-M	180,00	1	095390010
L-XL	180,00	1	095390011

## 9542AL

corta-vento impermeável, mangas compridas, em tecido respirável



	€	1	095420042
S	164,00	1	095420042
M	164,00	1	095420043
L	164,00	1	095420044
XL	164,00	1	095420045
XXL	164,00	1	095420046
XXXL	164,00	1	095420047



## 9542C

calções de ciclismo em lycra, elástico em silicone na extremidade das pernas, acolchoado de assento antibacteriano



	€	1	095420061
S	122,00	1	095420061
M	122,00	1	095420062
L	122,00	1	095420063
XL	122,00	1	095420064
XXL	122,00	1	095420065
XXXL	122,00	1	095420066

## 9542G

camisola de inverno, tecido respirável, fecho éclair longo, três bolsos posteriores, elástico em silicone na extremidade da camisola



	€	1	095420012
S	128,00	1	095420012
M	128,00	1	095420013
L	128,00	1	095420014
XL	128,00	1	095420015
XXL	128,00	1	095420016



## 95426W

Casaco, tecido respirável, corta vento, fecho eclair longo, elástico à volta da cintura, punhos de lycra, inserções refletoras traseiras, 3 bolsos traseiros exteriores, 1 com fecho



	€		
S	222,00	1	095420101
M	222,00	1	095420102
L	222,00	1	095420103
XL	222,00	1	095420104
XXL	222,00	1	095420105
XXXL	222,00	1	095420106

## 9542M

camisola de manga curta, tecido em microfibra respirável, fecho eclair longo coberto, três bolsos posteriores, um com fecho eclair, elástico em silicone na extremidade da camisola



	€		
S	128,00	1	095420051
M	128,00	1	095420052
L	128,00	1	095420053
XL	128,00	1	095420054
XXL	128,00	1	095420055
XXXL	128,00	1	095420056



## 9542S

calças interiores de inverno, em Lycra, acolchoado de assento antibacteriano e respirável



	€		
S	172,00	1	095420022
M	172,00	1	095420023
L	172,00	1	095420024
XL	172,00	1	095420025
XXL	172,00	1	095420026
XXXL	172,00	1	095420027



## 9598W-N

bicicleta de montanha Whistle®, quadro em alumínio, garfo Suntour XCT30, 29" 100 mm, caixa de velocidades Shimano RD-TX500, 7 velocidades, travões hidráulicos Shimano BR-M200 e 29" jantes em alumínio, laranja fluorescente / cinza antracite mate



	€		
9598W M-N	1.170,00	1	095980130
9598W L-N	1.170,00	1	095980132

## 9597TRIOWAY

TRIOWAY BY ATALA®

Sistema de propulsão auxiliar TRIOWAY by ATALA®, elétrico, pode ser acoplado à cadeira de rodas REHA COMFORT (incluída), bateria de lítio integrada na estrutura, guiador com controlos de direção e velocidade, com sistema de engate da cadeira de rodas integrado

CE



DISPONÍVEL MEDIANTE SOLICITAÇÃO



### ESTRUTURA

- Sistema de engate/desengate rápido para cadeira de rodas com alavanca
- Estrutura rebatível com dobradiça dupla
- Guiador ajustável verticalmente
- Travão de disco, 180 mm
- Luz LED frontal
- Roda dianteira com pneu de borracha

### DESEMPENHO

- Velocidade ajustável, até 15 km/h
- Botão avançar e retroceder
- Alcance: 20 km
- Acelerador de alavanca no guiador

### BATERIA

- Bateria de lítio recarregável de 7Ah
- Bateria integrada na estrutura, amovível
- Cabo de carga 230V 50 Hz (incluído)

### ACESSÓRIOS

- Ecrã multifunções, com capacidade residual da bateria e indicador de nível de carga
- Buzina
- Indicadores de direção
- Suporte para telemóvel (incluído)
- Botão ligar / desligar
- SISTEMA QUICK HOOK PRÉ-INSTALADO SOB A CADEIRA DE RODAS

### CADEIRA DE RODAS REHA CONFORT (incluída)

- Estrutura rebatível com dobradiça dupla
- Rodas de 24" com pneus maciços em PU
- Apoios de braços amovíveis
- Estribos ajustáveis e amovíveis

9597TRIOWAY

1 095970200



## 9598WHP-N

bicicleta de montanha Whistle®, quadro em alumínio, garfo Suntour XCM PL, 29" 100 mm, com bloqueio remoto, caixa de velocidades Shimano XT RD-M8100 Shadow Plus, 12 velocidades, travões hidráulicos Shimano BL-MT201/BR-MT200 e 29" jantes em alumínio, branco / vermelho mate



9598WHP M-N	€ 2.180,00	1	095980140
9598WHP L-N	€ 2.180,00	1	095980142

## 9599CB-N2

bicicleta de cidade Atala®, quadro Hi-Ten Tig TKK 700c, caixa de velocidades Shimano® Tourney RD-TZ50, 6 velocidades, travões V-Brake®, jantes em alumínio 28", com porta-bagagens, suporte e campainha, preto mate



9599CB-N2	€ 680,00	1	095990031
-----------	----------	---	-----------

## 9599CB-WN

bicicleta urbana Atala®, quadro em alumínio, caixa de velocidades Shimano® de 6 velocidades, travões V-Brake®, jantes 28" em alumínio, branco

- Quadro em alumínio
- Garfo Hi-Ten Tig TKK 700c
- Caixa de velocidades Shimano Tourney RD-TZ50 6 velocidades
- Travões V-brake
- Jantes em alumínio 28"
- Cor: branco



9599CB-WN	€ 680,00	1	095990024
-----------	----------	---	-----------

## 9597P

bomba de coluna com manómetro

- Adaptador para todos os tipos de válvulas de bicicletas (Schrader, Prestal/Sclaverand, Regina)
- Máx. 12 bar/ 180 psi



9597P	€ 66,00	1	095970100
-------	---------	---	-----------

## 9548KB

bicicleta de criança, quadro em alumínio, aros 12"; recomendada para crianças a partir dos 3 anos; peso máximo: 30 kg



9548KB	€ 171,00	1	095480110
--------	----------	---	-----------

## 9548KB 20

bicicleta de montanha de criança Atala® 20", quadro em aço Hi-Ten Tig 20", garfo de suspensão 30 mm, caixa de velocidades RD-TY21SS 6V, travões V-brake em alumínio e jantes em alumínio 36 furos, amarelo fluorescente / azul mate



9548KB 20	€ 550,00	1	095480120
-----------	----------	---	-----------

## 9548KB 24

bicicleta de montanha de criança Atala® 24", quadro em aço Hi-Ten Tig 24", garfo de suspensão, caixa de velocidades Shimano Tourney RD-TYZ50 6V, travões V-brake em alumínio e jantes em alumínio 36 furos, laranja fluorescente mate



9548KB 24	€ 585,00	1	095480122
-----------	----------	---	-----------



# Beta



### 9547T

carro de ferramentas "Kinder", para crianças a partir dos 3 anos, completo com ferramentas

CE



9547T € 69,50 1 095470100

### 9547WSK

bancada de trabalho com ferramenta "Kinder Work Station", para crianças a partir dos 3 anos de idade

CE



9547WSK H cm 74 € 128,00 1 095473801

### 9548G

"Mini Estação de Serviço", com 6 andares, com lavagem de carros, elevador e rampas



9548 G H cm 69 € 69,50 1 095480100

### 9524SC

garagem Beta miniatura para colecionadores



1:18 € 94,00 1 095240018

### 9526RMN

jogo de 2 baralhos de 55 cartas Modiano®



9526RMN € 30,00 1 095260001

### 9528C

bola de futebol, revestida a PU, tamanho 5

- circunferência: 68-70 cm
- painéis: 12
- peso: 410-430 g
- pressão recomendada: 6-8 lbs/ 0,41-0,55 bar/ 6-8 psi



9528C € 29,50 1 095280100

### 9520P

suporte para guarda-chuvas, em metal galvanizado, com tabuleiro apara-pingos, preto



9520P € 70,50 1 095200100

### 9521

guarda-chuva, nylon T210, estrutura alumínio 3-secções, mecanismo automático de abertura/fecho



9521 € 32,50 1 095210000

### 95210B

guarda chuva nylon 210T, diâmetro 120 cm



95210B ø cm 100 € 36,00 1 095210021

### 9522A

abre garrafas com punho ergonómico



9522A € 18,00 1 095220010



# Beta



## 9523A

garrafa de alumínio, 500ml



9523A	ml	€		
500	12,40	1	095230005	

## 9523T

garrafa térmica, em aço inox, 500 ml, tecnologia de camada dupla, sem ar entre as camadas, tampa anti-fugas, laranja

- mantém bebidas frescas durante 24 horas
- mantém bebidas quentes durante 12 horas



EC1935/EC2023

9523T	ml	L	mm	€		
500	255	22,50	1	095230050		

## 9528B

garrafa em polietileno, 500 ml



9528B	ml	€		
500	7,10	1	095280005	

## 9526F

mini frigorífico, classe de eficiência energética F, capacidade 63 l, preto

CE



9526F	L	S	H	mm	mm	mm	€		
474	450	640	555,00	1	095260005				

## 9526MC

máquina de café expresso de cápsulas

CE



9526MC	L	S	H	mm	mm	mm	€		
358	128	255	240,00	1	095260020				

## 9527 6T

conjunto de 6 chávenas de café



9527 6T	€		
103,00	1	095270001	

## 9527T

chávena de cerâmica preta com logótipo BETA gravado a laser



9527T	€		
20,00	1	095270030	

## 9586K

faca multíusos, 10 funções



9586K	€		
17,30	1	095860100	



## 9549ABW

fone wireless BT V5.0, com microfone, carga magnética, base de carga USB-C, preto

CE



9549ABW	L	H	S	mm	mm	mm	€		
61	34,5	41	35,00	1	095490091				

## 9549BP

bateria portátil, 10000mAh



9549BP	€		
23,90	1	095490052	

## 9549BRW

base de carregamento sem fios, com função de carregamento rápido e indicador do nível de carga

- Fornecida com cabo USB-USB Tipo C para ligação a transformador, 1 m comprimento
- Compatível com todos os dispositivos de carregamento sem fio
- Potência entrada: DC 5V/2A, 9V/2A, 12V/1.5A
- Potência saída: 5W/ 7.5W/ 10W/ 15W

CE



9549BRW	Ø	H	mm	mm	€		
58	6	34,00	1	095490100			

## 9549C

pen USB, 32 GB



9549C	€		
22,00	1	095490062	



## 9549CR

cabo de carregamento 4 em 1, em nylon trançado, com opção de carregamento rápido

- Conector USB tipo A
- Conector iluminação para dispositivos Apple
- Conector de carregamento Micro USB
- Conector de carregamento USB-C
- Conector de carregamento e transmissão de dados USB-C



9549CR	L mm 120	€ 18,50	1	095490042
--------	----------------	------------	---	-----------

## 9549MPC

base de carregamento multi-portas, 6 portas USB, para múltiplos carregamentos até uma potência de entrada máx. de 65 W

- 4 portas USB, 5V 2.4A
  - 1 porta USB, Q.C 3.0
  - 1 porta USB-C, 20W PD
- com interruptor ON/OFF separado, monitor LED para verificar potência total, número de portas e intensidade da corrente

CE



9549MPC	L mm 110	S mm 72	H mm 35	€ 57,00	1	095490082
---------	----------------	---------------	---------------	------------	---	-----------

## 9549SBW

altifalante BT sem fios, portátil, 6 funções

- BT versão 5.0
- FUNÇÕES:
- BT
  - cartão TF
  - USB
  - audio jack 3.5 mm
  - rádio FM
  - chamada

CE



9549SBW	L mm 73	S mm 73	H mm 124	€ 46,50	1	095490072
---------	---------------	---------------	----------------	------------	---	-----------

## 9547

calculadora de mesa

CE



9547	€ 21,20	1	095470000
------	------------	---	-----------

## 9592AC

caneta em alumínio preto com ponta de borracha para ecrã tátil  
Fornecida em estojo individual



9592AC	€ 4,00	1	095920010
--------	-----------	---	-----------

## 9592B/C50

kit de 50 canetas



9592B/C50	€ 51,50	1	095920050
-----------	------------	---	-----------

## 9592B/P

canetas personalizadas



9592B/P	€ 1,54	500	095920051
---------	-----------	-----	-----------

## 9592MG/3

estojo com três lápis pretos de grafite



9592MG/3	€ 25,00	1	095920103
----------	------------	---	-----------

## 9588M

tabuleiro em espuma macia com 1 caneta e 2 blocos de notas



9588M	€ 21,80	1	095880011
-------	------------	---	-----------

## 9587 9x14

bloco de notas, 9x14 cm



9587 9X14	L cm 9	H cm 14	€ 14,00	5	095870009
-----------	--------------	---------------	------------	---	-----------

## 9587 13x21

bloco de notas, 13x21 cm



9587 13X21	L cm 13	H cm 21	€ 17,90	5	095870013
------------	---------------	---------------	------------	---	-----------

## 9588/10PI

10 jogos de blocos de notas com folhas adesivas



9588S/10PI	€ 28,00	1	095880055
7,5x7,5 cm			



## 9588S/10...

10 jogos de blocos de notas



9588S/10A	€ 30,00	1	095881001
21x29 cm			
9588S/10B	€ 28,50	1	095881002
15x21 cm			
9588S/10C	€ 21,00	1	095881003
10x15 cm			
9588S/10D	€ 13,40	1	095880054
7,5x10,5 cm			

## 9589A/36

pack de 36 rolos de fitas adesivas com logótipo Beta



9589A/36	€ 144,00	1	095890035
----------	----------	---	-----------

## 9589B/36

pack de 36 rolos de fitas adesivas com logótipo Beta, brancas



9589B/36	€ 153,00	1	095890036
----------	----------	---	-----------

## 9594

relógio com termómetro e higrómetro, 26 cm de diâmetro



9594	€ 31,50	1	095940051
∅ cm	26		

## 9595C

porta-chaves em pele



9595C	€ 9,40	1	095950011
-------	--------	---	-----------

## 9595T

porta-chaves em metal cromado, numa bolsa de veludo



9595T	€ 7,90	1	095950021
-------	--------	---	-----------

## 9596

correia porta-chaves/telemóvel em poliéster, com mosquetão metálico e cordão para telemóvel



9596	€ 5,20	10	095961001
------	--------	----	-----------

## 9569MS

saco, em polipropileno



9569MS	€ 6,80	5	095690052
L cm	60	H cm	40

## 9569MS-2

saco, em polipropileno rígido



9569MS-2	€ 6,80	5	095690055
L cm	45	H cm	40

## 9569P

saco, em polietileno, lados dobrados



9569P	€ 0,84	50	095691001
L cm	34	H cm	44

## 9569S

sacos TNT, 38x42 cm, pegas longas



9569S	€ 2,57	50	095690051
L cm	38	H cm	42



## 9563G

Cadeira de escritório



9563G	€ 260,00	1	095630050
-------	----------	---	-----------

## 9563U

cadeira de escritório com braços, ergonómica



9563U	€ 540,00	1	095630020
-------	----------	---	-----------

## 9565K

Mesa bidão com dois assentos



9565K	€ 940,00	1	095650500
-------	----------	---	-----------

## 9565S

Bidão em folha de aço, com assento em imitação de cabedal amovível



9565S	H cm 60	ø mm 38	€ 219,00	1	095650300
-------	---------	---------	----------	---	-----------

## 9565T

Mesa bidão em chapa de aço, com tampo em bétula envernizada

Fornecido com um KIT duplo de tubos de espaçamento (7cm ou 20cm) para ajuste vertical



9565T	H cm 95 → 108	ø cm 70	€ 500,00	1	095650200
-------	---------------	---------	----------	---	-----------

## 9566K

sortido de mobiliário, mesa e três bancos 9566S/3, com regulação vertical



9566K	H mm 920 ÷ 1120	€ 389,00	1	095660500
-------	-----------------	----------	---	-----------

## 9566S/3

jogo de 3 bancos com regulação vertical



9566S/3	H mm 620 ÷ 840	€ 280,00	1	095660300
---------	----------------	----------	---	-----------

## 9562P2

tapete para oficina, 200x80 cm

• particularmente adequado para utilização com o equipamento de oficina C55 ou sob motocicletas



9562P2	L cm 200	H cm 80	€ 174,00	1	095620400
--------	----------	---------	----------	---	-----------

## 9562P12

tapete para oficina, 12 m x 80 cm

Permite personalizar o comprimento conforme necessário



9562P12	L m 12	H cm 80	€ 880,00	1	095620425
---------	--------	---------	----------	---	-----------

## 9562TB

tapete para experimentar sapatos, com parte de trás antiderrapante em borracha



9562TB	L mm 800	H mm 600	€ 49,50	1	095620500
--------	----------	----------	---------	---	-----------

## 9562T1

tapete para oficina, 100x80 cm

particularmente adequado para utilização com BETA 3071 e 3071B

• borracha antiderrapante de limpeza fácil



9562T1	L cm 100	H cm 80	€ 91,00	1	095620150
--------	----------	---------	---------	---	-----------



## 9562T2

tapete para bancada de trabalho, 200x160 cm

- protege o chão de derrames de óleo e combustível, respeita o meio ambiente
- limpeza fácil, parte de trás antiderrapante em borracha



	L cm	H cm	€	1	095620200
9562T2	200	160	248,00	1	095620200

## 9562T3

tapete para oficina

Dimensões: 300x160 cm

- particularmente adequado para utilização sob motocicletas
- protege o chão de derrames de óleo e combustível, respeita o meio ambiente
- limpeza fácil, parte de trás antiderrapante em borracha



	L cm	H cm	€	1	095620300
9562T3	300	160	360,00	1	095620300

## 9559

faixa publicitária em TNT, em módulos de 3x0,8m



	L m	H m	€	1	095591001
9559	3	0,8	30,00	1	095591001

## 9559/30MT

faixa publicitária com 10 logótipos BETA (30m)



	L m	H m	€	1	095591031
9559/30MT	30	0,8	283,00	1	095591031

## 9559/S

banner promocional para exterior, dimensão 3x0,8 m

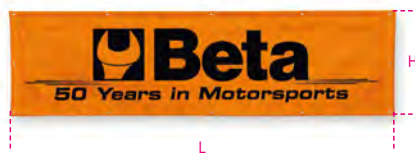

	L m	H m	€	1	095591011
9559/S	3	0,8	105,00	1	095591011

## 9561V

bandeira de vela, 4x0.75 m, mastro de metal cromado, base em cimento, 50 cm



	L mt	H mt	€	1	095610001
9561V	0,75	4	650,00	1	095610001

## 9561VV

Bandeira , 4x0.75 m



	L mt	H mt	€	1	095610101
9561VV 4,0	0,75	3,50	370,00	1	095610101

## 9561VV 2,5

bandeira promocional 2.5x0.50 m com mastro



	L mt	H mt	€	1	095610201
9561VV 2,5	0,50	2,5	225,00	1	095610201

## 9562

abrigo totalmente fechado, 3 m x 3 m, quatro paredes montáveis - 3 com janelas e 1 com porta



	L cm	H cm	S cm	€	1	095620020
9562	300	348	300	1.890,00	1	095620020



# ARTIGOS ELIMINADOS - ARTIGOS DE SUBSTITUIÇÃO/RECOMENDADOS

ARTIGO ELIMINADO
ARTIGO DE SUBSTITUIÇÃO
ARTIGO RECOMENDADO

42AS 1/4	000420106	42AS 1/4 NEW	000421106
42AS 9/32	000420107	42AS 9/32 NEW	000421107
42AS 5/16	000420108	42AS 5/16 NEW	000421108
42AS 3/8	000420110	42AS 3/8 NEW	000421110
42AS 7/16	000420111	42AS 7/16 NEW	000421111
42AS 1/2	000420113	42AS 1/2 NEW	000421113
42AS 9/16	000420114	42AS 9/16 NEW	000421114
42AS 19/32	000420115	42AS 19/32 NEW	000421115
42AS 5/8	000420116	42AS 5/8 NEW	000421116
42AS 11/16	000420117	42AS 11/16 NEW	000421117
42AS 3/4	000420119	42AS 3/4 NEW	000421119
42AS 13/16	000420121	42AS 13/16 NEW	000421121
42AS 7/8	000420122	42AS 7/8 NEW	000421122
42AS 15/16	000420124	42AS 15/16 NEW	000421124
42AS 1	000420125	42AS 1 NEW	000421125
42AS 1.1/16	000420127	42AS 1.1/16 NEW	000421127
42AS 1.1/8	000420129	42AS 1.1/8 NEW	000421129
42AS 1.1/4	000420132	42AS 1.1/4 NEW	000421132
42AS 1.5/16	000420133	42AS 1.5/16 NEW	000421133
42AS 1.3/8	000420135	42AS 1.3/8 NEW	000421135
42AS 1.7/16	000420136	42AS 1.7/16 NEW	000421136
42AS 1.1/2	000420138	42AS 1.1/2 NEW	000421138
42AS/B9N	000420159	42AS/B9N	000421159
42AS/13	000420163	42AS/13	000421163
42AS/16	000420166	42AS/16	000421166
42AS/17	000420168	42AS/17	000421168
42MP 6	000420606	42MP 6	000421606
42MP 7	000420607	42MP 7	000421607
42MP 8	000420608	42MP 8	000421608
42MP 9	000420609	42MP 9	000421609
42MP 10	000420610	42MP 10	000421610
42MP 11	000420611	42MP 11	000421611
42MP 12	000420612	42MP 12	000421612
42MP 13	000420613	42MP 13	000421613
42MP 14	000420614	42MP 14	000421614
42MP 15	000420615	42MP 15	000421615
42MP 16	000420616	42MP 16	000421616
42MP 17	000420617	42MP 17	000421617
42MP 18	000420618	42MP 18	000421618
42MP 19	000420619	42MP 19	000421619
42MP 20	000420620	42MP 20	000421620
42MP 21	000420621	42MP 21	000421621
42MP 22	000420622	42MP 22	000421622
42MP 24	000420624	42MP 24	000421624
42MP 27	000420627	42MP 27	000421627
42MP 30	000420630	42MP 30	000421630
42MP 32	000420632	42MP 32	000421632
42MP/S17	000420652	42MP/S17	000421652
42MP/S21	000420653	42MP/S21	000421653
42MP/B9N	000420661	42MP/B9N	000421661
42HS/AS 1/4	000424106		
42HS/AS 5/16	000424108		
42HS/AS 3/8	000424110		
42HS/AS 7/16	000424111		
42HS/AS 1/2	000424113		
42HS/AS 9/16	000424114		
42HS/AS 5/8	000424116		
42HS/AS 11/16	000424117		
42HS/AS 3/4	000424119		
42HS/AS 13/16	000424121		
42HS/AS 7/8	000424122		
42HS/AS 15/16	000424124		
42HS/AS 1	000424125		
42HS/AS 1.1/16	000424127		
42HS/AS 1.1/8	000424129		
42HS/AS 1.1/4	000424132		
42HS/AS 1.5/16	000424133		
55MP 6X7	000550603		
55MP 8X9	000550606		
55MP 10X11	000550609		
55MP 12X13	000550612		
55MP 14X15	000550615		
55MP 16X17	000550618		
55MP 18X19	000550621		
55MP 20X22	000550624		
55MP 21X23	000550627		
55MP 24X26	000550630		
55MP 25X28	000550633		
55MP 27X29	000550636		
55MP 30X32	000550639		
55MP/S8	000550650		
55MP/S13	000550651		
55MP/S12	000550653		
96C-AS 1/16	000961702	96AS 1/16	000960702
96C-AS 3/32	000961706	96AS 3/32	000960706
96C-AS 1/8	000961710	96AS 1/8	000960710

96C-AS 5/32	000961714	96AS 5/32	000960714
96C-AS 3/16	000961716	96AS 3/16	000960716
96C-AS 7/32	000961718	96AS 7/32	000960718
96C-AS 1/4	000961720	96AS 1/4	000960720
96C-AS 5/16	000961724	96AS 5/16	000960724
96C-AS 3/8	000961728	96AS 3/8	000960728
97BTX-C 09	000971609	97BTX 09	000970109
97BTX-C 10	000971610	97BTX 10	000970110
97BTX-C 15	000971615	97BTX 15	000970115
97BTX-C 20	000971620	97BTX 20	000970120
97BTX-C 25	000971625	97BTX 25	000970125
97BTX-C 27	000971627	97BTX 27	000970127
97BTX-C 30	000971630	97BTX 30	000970130
97BTX-C 40	000971640	97BTX 40	000970140
188 10	001880010		
188 15	001880015		
339A	003390011		
339A/R	003390061		
366 350	003660035		
388 14	003880014		
388 16	003880016		
410AS 1/16	004100371		
410AS 5/64	004100372		
410AS 3/32	004100373		
410AS 7/64	004100374		
410AS 1/8	004100375		
410AS 9/64	004100376		
410AS 5/32	004100377		
410AS 11/64	004100378		
410AS 3/16	004100379		
410AS 13/64	004100380		
410AS 7/32	004100381		
410AS 15/64	004100382		
410AS 1/4	004100383		
410AS 17/64	004100384		
410AS 9/32	004100385		
410AS 19/64	004100386		
410AS 5/16	004100387		
410AS 21/64	004100388		
410AS 11/32	004100389		
410AS 23/64	004100390		
410AS 3/8	004100391		
410AS/SP21	004100429		
410AS/SPV1	004100430		
410AS/SEL21	004100433		
423 6	004230006	423CO 6	004230106
423 7	004230007	423CO 7	004230107
423 8	004230008	423CO 8	004230108
423 10	004230010	423CO 10	004230110
423A 6,5	004230015	423A-CO 6,5	004230115
423A 8,0	004230020	423A-CO 8	004230120
426/SB6	004260106		
428/C14	004280201	428FP/C7	004280203
428/C14	004280201	428FC/C7	004280204
428/SPV	004280202	428F/SPV	004280205
429/C14	004290201	429FP/C7	004290203
429/C14	004290201	429FC/C7	004290204
437K/16	004370016		
437K/8	004370020		
598/200SL	005980022		
599DGT-AW/10	005990610	599DGT-AW/135	005990713
599DGT-AW/20	005990620	599DGT-AW/340	005990734
665/6	006650006	666/5	006660705
665/10	006650010	666/10	006660710
665/10X	006650011	666/10X	006660711
665/20	006650020	666/20	006660720
665/30	006650030	666/30	006660730
665SW	006650100		
665LB/6	006650106	666-LBF.FT/5	006660765
665LB/10	006650110	666-LBF.FT/10	006660780
665LB/10X	006650111	666-LBF.FT/10X	006660781
665LB/20	006650120	666-LBF.FT/20	006660782
665LB/30	006650130	666-LBF.FT/30	006660783
720FTX 10	007200410		
720TC 90	007200769		
720TC 100	007200770		
720TC 110	007200771		
720TC 120	007200772		
720TC 135	007200773		
852 10	008520010		
860MIX/A10	008600900	861MIX/A10	008610800
860MIX/A31	008600902	861MIX/A31	008610802
860PHZ/A10	008600910	861PHZ/A10	008610810
860PE/A10	008600920	861PE/A10	008610820
860TX/A10	008600970	861TX/A10	008610870
861RIBE 5	008610705		
861RIBE 6	008610706		
861RIBE 7	008610707		
861RIBE 8	008610708		
861RIBE 9	008610709		
861XZN 5	008610725		
861XZN 6	008610726		

861XZN 8	008610728		
866RTX 40	008660520		
866RTX 45	008660525		
866RTX 50	008660530		
866RTX 55	008660535		
866RTX 60	008660540		
866RTX 70	008660545		
900/55	009000870	900/55	009001155
900MC 4	009002040		
900MC 5	009002050		
900MC 6	009002060		
900MC 7	009002070		
900MC 8	009002080		
900MC 9	009002090		
900MC 10	009002100		
900MC 11	009002110		
900MC 12	009002120		
900MC 13	009002130		
900MC 14	009002140		
900E-HS/55	009004880	900HS/55	009004155
900/55K	009009870	900/55	009001155
910/R55Q	009100877		
910/55	009100882	910/55	009101155
910/55Q	009100885		
910A/C16Q	009100932	910A/C16	009100936
910B/C16Q	009100933	910B/C16	009100937
910E-HS/55	009104880	910HS/55	009104155
910/55K	009109882	910/55	009101155
920/50	009200871	920/50	009201150
920/R55Q	009200877	920/RN55Q	009201126
920/55	009200882	920/55	009201155
920/55Q	009200885	920/55Q	009201156
920/50F	009200889	920/50F	009201151
920/55X	009200895	920/55X	009201158
920/55LC	009200896	920/55LC	009201159
920A/C21X	009200983	920A/C21	009200952
920U/C17M	009201797		
920E-HS/55LC	009204860	920HS/55LC	009204159
920/55K	009209882	920/55	009201155
928/R55	009280859	928/RN55	009281115
928/55	009280862	928/55	009281155
955 20,8	009550021		
956L 17,8	009560217		
960 27	009600027		
960T/A	009600032		
960T/B	009600033		
960T/C	009600034		
960T/F	009600037		
960T/G	009600038		
960T/H	009600039		
960/22EP 300	009600052		
960YP 13	009600063		
960YP 14	009600064		
960YP 17	009600067		
960D/13	009600073		
960D/14	009600074		
960D/17	009600077		
960F	009600148		
960G	009600151		
960H/C4	009600152		
960L	009600153		
960M	009600154		
960B/C/5	009600280		
960AD/TP2	009600510	1464CBD	014640300
961P6	009610000	961N	009610030
1047BM 240	010470340	1047 240	010470240
1129BM	011290000		
1129BMK	011290000		
1134 35	011340032		
1134A 45	011340045		
1134RL	011340132		
1344	013440010		
1360G	013600000		
1362B	013620011		





# ARTIGOS ELIMINADOS - ARTIGOS DE SUBSTITUIÇÃO/RECOMENDADOS

	ARTIGO ELIMINADO
	ARTIGO DE SUBSTITUIÇÃO
	ARTIGO RECOMENDADO

1462AD/BSC	014620435		
1462AD/SMN	014620436		
1463/KIT	014630001		
1464T	014640050		
1464IC	014640350		
1464IC-RK	014640377		
1464AP	014640450	1464APD	014640100
1464AP T12X12	014640453		
1464AP T12X14	014640454		
1464AP T14X12-M1,0	014640455		
1464AP T16X12	014640456		
1464FG	014640470	1464APD	014640100
1464FG/CP4	014640475	1464APD	014640100
1464TDI	014640600	1464BP	014640200
1464ADB	014640620	1464BP	014640200
1464PF	014640650		
1464PB	014640700	1464BP	014640200
1466TLF	014660201		
1466L 11	014660211		
1467/RK2	014670502		
1470PF	014700200		
1471A	014710010		
1471M/W50	014710079		
1471M/P	014710080		
1471PN/B1	014710081		
1471PN/B2	014710082		
1471PN/B3	014710083		
1471PN/B4	014710084		
1471PN/B5	014710085		
1472H	014720000		
1472FCA	014720041		
1472TM	014720200		
1472MT/VW	014720500		
1473T	014730582		
1474/C4	014740100		
1474E/VW	014740120		
1474E/VW2	014740150		
1475U	014750010		
1476T	014760200		
1477K7	014770051		
1477D 13	014770113		
1477D 15	014770115		
1477D 16	014770116		
1477D 17	014770117		
1477D 19	014770119		
1479ML/S3	014790603		
1479ML/B17	014790700		
1482A/1	014820005	1482A/1B	014820004
1482A/5	014820015		
1482D	014820026		
1483K/12	014830012		
1483K/22	014830022		
1484PSA	014840012		
1485BPM	014850002		
1485VAG/12,5	014850062		
1485VAG/21,5	014850071		
1485VAG/K2	014850080		
1485MJ	014850150		
1485PMTJ	014850190		
1485FCA/T	014850210		
1485FCA/TS	014850215		
1485FRD/T	014850310		
1485MRC/T	014850315		
1485VLV/T	014850320		
1487/K2	014870100		
1489/33P	014890015		
1489/31T	014890016		
1489/R	014890020		
1489/E	014890025		
1489/C14	014890100		
1493FT	014930085		
1493VV	014930086		
1493HK	014930087		
1493FF	014930127	1493FF/2	014930128
1493 74-L15	014930210		
1493 90-L15	014930234		
1493 92-L10	014930236		
1493 93-L15	014930238		
1493 96-L18	014930246		
1493AL 79-L15	014930325		
1493AL 87-L16	014930335		
1493AL/CF 36	014930436		
1493B/S5	014930599		
1493C/ADB	014930900		
1493U/ADB	014930910		
1497KB/S3	014970050		

1497/S3	014970400		
1498MN/12-U	014980009		
1498SM-C	014980021		
1498SM-CP	014980022		
1498SM-A	014980023		
1498/4A	014980104	1498H/4A	014980204
1498/8A	014980108	1498H/8A	014980208
1498/25A	014980125	1498H/25A	014980225
1498/16A	014980126	1498H/16A	014980216
1498/40A	014980140		
1498/120A	014980142		
1498TB/12-24	014980401	1498TB/12-24N	014980402
1498ST/TB	014980410		
1498/12	014980480		
1498/24	014980490		
1498B/12-R02	014980502		
1505/C5	015050300		
1529/PG	015290010		
1529/C7	015290100		
1530/C16	015300316		
1533PR/5A	015330016		
1549	015490001		
1555C	015550202		
1557 37	015570137		
1557 46	015570146		
1557 56	015570156		
1557V	015570299		
1563/C4	015630010		
1566N 45X190	015660008		
1566P	015660091		
1650FT/1	016500060		
1650FT/2	016500070		
1717A 200	017170020		
1717B 250	017170125		
1730M 150	017300215		
1730M 200	017300220		
1730M 250	017300225		
1730V 38	017300338		
1741B	017410000	1741	017410003
1741B/C5	017410025	1741/C5	017410035
1741BP	017410350	1741P	017410303
1750CG 400	017500140	1750PF 400	017500141
1750CG 600	017500160	1750PF 550	017500161
1756C	017560502	1756V	017560504
1756C-20R	017560503	1756V-20R	017560505
1758A	017580010		
1760/OHM	017600025	1760OHM/2	017600027
1760PT	017600150	1760PT/N	017600155
1765/C24	017650001		
1766L	017660015		
1766LI	017660016		
1770BM	017700050	1770A	017700025
1833 L/USB	018330054	1833 L	018330004
1833RB-L/USB	018330975		
1837F	018370050	1837F/USB	018370060
1837M	018370450		
1837M/RA	018370975		
1838P	018380005	1838PN	018380008
1838COB	018380010	1838COMPACT	018380011
1838UV	018380150		
1860BH/120A	018600121		
1860BH/160A	018600161		
1860BHT/160A	018600179		
1860BH/200A	018600201		
1860SQ	018600210		
1860RG	018600255		
1860EI	018600290		
1860M	018600301		
1860DM 16	018600310		
1860DM 40	018600311		
1860PMIG	018600350		
1860BH R/CM	018600612		
1860BH R/CS	018600613		
1860BHT/T	018600615		
1860BHT R/CM	018600616		
1860BHT R/CS	018600617		
1878 3	018780003		
1884/C12	018840100		
1885/C1	018850110		
1885/C1-R3	018850113		
1885/C1-R4	018850114		
1885/C1-R5	018850115		
1885/C1-R7	018850117		
1885/C2	018850120		
1885/C2-R2	018850122		
1885/C2-R3	018850123		
1885/C2-R4	018850124		
1885/C2-R5	018850125		
1885/C3	018850130		
1885/C3-R1	018850131		
1885/C3-R2	018850132		
1895G	018950800	1895GSI	018950810

1897	018970066		
1897CRB	018970101		
1897MV	018970103		
1897G	018970104		
1915C/L 11X16	019150116		
1916P 6X14	019160256		
1916P 8X17	019160258		
1916P 10X19	019160260		
1916S 6X8	019160306		
1916S 8X10	019160308		
1916S 10X12	019160310		
1917ST 6X8	019170306		
1917ST 8X10	019170308		
1917ST 10X12	019170310		
1918 1/8X6	019180106		
1918 1/8X8	019180108		
1918 1/4X6	019180116		
1918N 3/8X3/8	019180310		
1918N 1/2X1/2	019180320		
1924CD	019240007		
1924B	019240021		
1927CD	019270007	1927C	019270006
1927B	019270022	1927E	019270005
1927CD/K3	019270107		
1927B/K5	019270122		
1928CD	019280007	1928P	019280006
1930CD	019300022	1930PA	019300032
1945C	019450200		
1945C/G 16	019450216		
1945C/G 19	019450219		
1945C/G 22	019450222		
1945C/G 25	019450225		
1945C/G 28	019450228		
1945C/G 32	019450232		
1945C/G 35	019450235		
1945C/G 38	019450238		
1945C/G 40	019450240		
1945C/GP 15	019450255		
1945C/GP 16	019450256		
1945C/GP 20	019450260		
1945C/GP 25	019450265		
1945C/GP 30	019450270		
1945C/GP 32	019450272		
1945C/GP 35	019450275		
1945C/GP 38	019450278		
1945C/GP 40	019450280		
1945C/GP 45	019450285		
1945C/GP 50	019450290		
1949GPN	019490011		
1995MQ/G1	019950010	1997MQ/GM9	019970109
1995MQ/G2	019950013	1997MQ/GM10	019970110
1996MQ/GM 9	019960109	1997MQ/GM9	019970109
1996MQ/GM 10	019960110	1997MQ/GM10	019970110
1996SVG	019960133	1996VPG	019960134
2080/D10	020800070		
C4	021040000		
2104VU/0	021041122		
TV280	024000478	TV271	024000475
T18	024240018	T28	024240028
T19	024240019	T29	024240029
T22	024240022	T24	024240024
T281	024240281	T271	024240271
M31	024500031	M32	024500032
M39	024500039		
M79	024500079		
M219	024500219		
M305	024500305		
M310	024500310		
MB38	024504238		
MB45	024504245		
MB56	024504256		
MV39	024510039		
MV79	024510079		
MV82	024510082	MV84	024510084
MV83	024510083	MV87	024510087
MV90	024510090	MV89	024510089
MV92	024510092	MV93	024510093
MV94	024510094	MV95	024510095
MV96	024510096	MV97	024510097
MV100	024510100	MV104	024510104
MV116	024510116	MV117	024510117
MV120	024510120	MV119	024510119
MV126	024510126	MV139	024510139
MV305	024510305		
MV310	024510310		
MV105	024510871	MV107	024510107
MBV35	024524235		
MBV36	024524236	MBV29	024524229
MBV40	024524240	MBV27	024524227
MBV45	024524245		
MBV47	024524247	MBV70	024524270
MBV56	024524256		



# ARTIGOS ELIMINADOS - ARTIGOS DE SUBSTITUIÇÃO/RECOMENDADOS

	ARTIGO ELIMINADO
	ARTIGO DE SUBSTITUIÇÃO
	ARTIGO RECOMENDADO

MMV100	024590100	MMV104	024590104
MMV105	024590105	MMV107	024590107
MCV20	027510021	MCV24	027510024
3014SAR/2	030140362		
3027/PR	030270400	3027PR/N	030270410
3070BE/S	030700201		
3070BE/F	030700202		
3070BE/B	030700203		
3070BE/K	030700250		
3075A 28	030750028		
3075A 30	030750030		
3079/21	030790021		
3091/10	030910010		
3091/20	030910020		
3092/10	030920010		
3092/20	030920020		
3092/30	030920030		
3092/35	030920035		
3092/40	030920040		
3094PA-O	030940101		
3094PA-G	030940102		
3094PA-R	030940103		
3700-COVER C37	037000930		
C38-O	038000001		
C38-R	038000002		
C38-G	038000003		
C38LA O	038000071		
C38LA R	038000072		
C38LA G	038000073		
C38L-O	038000081		
C38L-R	038000082		
C38L-G	038000083		
C38T-O	038000091		
C38T-R	038000092		
C38T-G	038000093		
C38C-O	038000201		
C38C-R	038000202		
C38C-G	038000203		
MCV21	041510021	MCV17	041510017
C45PRO X	045000001	C45PRO 2.0 X	045002001
C45PRO W	045000002	C45PRO 2.0 W	045002002
C45PRO AX	045000003	C45PRO 2.0 AX	045002003
C45PRO AW	045000004	C45PRO 2.0 AW	045002004
C45PRO BX	045000021	C45PRO 2.0 BX	045002021
C45PRO BW	045000022	C45PRO 2.0 BW	045002022
C45PRO CX	045000023	C45PRO 2.0 CX	045002023
C45PRO CW	045000024	C45PRO 2.0 CW	045002024
C45PRO DX	045000031	C45PRO 2.0 DX	045002031
C45PRO DW	045000032	C45PRO 2.0 DW	045002032
C45PRO EX	045000033	C45PRO 2.0 EX	045002033
C45PRO EW	045000034	C45PRO 2.0 EW	045002034
C45PRO FX	045000035	C45PRO 2.0 FX	045002035
C45PRO GX	045000036	C45PRO 2.0 GX	045002036
C45PRO GW	045000037	C45PRO 2.0 GW	045002037
C45PRO HX	045000038	C45PRO 2.0 HX	045002038
C45PRO HW	045000039	C45PRO 2.0 HW	045002039
C45PRO BPX-1,3	045000041	C45PRO 2.0 BPX-1,3	045002041
C45PRO BPX-2,0	045000042	C45PRO 2.0 BPX-2,0	045002042
C45PRO FW	045000045	C45PRO 2.0 FW	045002045
C45PRO BPW-1,3	045000051	C45PRO 2.0 BPW-1,3	045002051
C45PRO BPW-2,0	045000052	C45PRO 2.0 BPW-2,0	045002052
C45PX/1-0,7MT	045000101	C45PRO 2.0 PXE/1,0,7MT	045002131
C45PX/2-1,3MT	045000103	C45PRO 2.0 PXE/2,1,3MT	045002133
C45PX/3-2,0MT	045000110	C45PRO 2.0 PXE/3,2,0MT	045002140
C45PW/1-0,7MT	045000111	C45PRO 2.0 PWE/1-0,7MT	045002141
C45PW/2-1,3MT	045000113	C45PRO 2.0 PWE/2-1,3MT	045002143
C45PW/3-2,0MT	045000120	C45PRO 2.0 PWE/3-2,0MT	045002150
C45PRO M7A/X	045000161	C45PRO 2.0 M7A/X	045002161
C45PRO M7A/W	045000171	C45PRO 2.0 M7A/W	045002171
C45PRO C5	045000225	C45PRO 2.0 C5	045002226
C45PRO C7	045000227	C45PRO 2.0 C7	045002228
C45PRO ML	045000233	C45PRO 2.0 ML	045002233
C45PRO RD/W	045000240	C45PRO 2.0 RD/W	045002240
C45PRO RD/X	045000241	C45PRO 2.0 RD/X	045002241
C45PRO CORNER/X	045000401	C45PRO 2.0 CORNER/X	045002401
C45PRO CAI/W	045000402	C45PRO 2.0 CAI/W	045002402
C45PRO CORNER/W	045000411	C45PRO 2.0 CORNER/W	045002411
C45PRO CAI/X	045000412	C45PRO 2.0 CAI/X	045002412
RSC50	050001000	RSC50 2.0	050001001
RSC50 A	050001005	RSC50 2.0 A	050001006
RSC50 B	050001010	RSC50 2.0 B	050001011
RSC50 C	050001015	RSC50 2.0 C	050001016
RSC50 D	050001020	RSC50 2.0 D	050001021
RSC50 E	050001025	RSC50 2.0 E	050001026
RSC50 F	050001030	RSC50 2.0 F	050001031
RSC50 G	050001035	RSC50 2.0 G	050001036

RSC50 H	050001040	RSC50 2.0 H	050001041
RSC50 I	050001045	RSC50 2.0 I	050001046
RSC50 L	050001050	RSC50 2.0 L	050001051
RSC50 PG/1-0,7MT	050001107	RSC50 2.0 NPG/1-0,7MT	050001118
RSC50 PA/1-0,7MT	050001108	RSC50 2.0 NPA/1-0,7MT	050001117
RSC50 PG/2-1,5MT	050001114	RSC50 2.0 NPG/2-1,5MT	050001125
RSC50 PA/2-1,5MT	050001115	RSC50 2.0 NPA/2-1,5MT	050001124
RSC50 PG/3-2,2MT	050001122	RSC50 2.0 NPG/3-2,2MT	050001133
RSC50 PA/3-2,2MT	050001123	RSC50 2.0 NPA/3-2,2MT	050001132
RSC50 MA	050001222	RSC50 2.0 MA	050001262
RSC50 M4	050001224	RSC50 2.0 M4	050001264
RSC50 M5	050001225	RSC50 2.0 M5	050001265
RSC50 M7	050001227	RSC50 2.0 M7	050001267
RSC50 M8	050001228	RSC50 2.0 M8	050001268
RSC50 M10	050001230	RSC50 2.0 M10	050001231
RSC50 MS-AVV	050001241	RSC50 2.0 MS-AVV	050001281
RSC50 MS-2AVV	050001242	RSC50 2.0 MS-2AVV	050001282
RSC50 MS-2C	050001243	RSC50 2.0 MS-2C	050001283
RSC50 ML	050001244	RSC50 2.0 ML	050001284
RSC50 CS	050001245	RSC50 2.0 CS	050001285
RSC50 MDO	050001250	RSC50 2.0 MDO	050001290
RSC50 AC-A	050001329	RSC50 2.0 NAC-A	050001339
RSC50 AC-G	050001330	RSC50 2.0 NAC-G	050001340
RSC50 KAI-G	050001335	RSC50 2.0 KNAI-G	050001346
RSC50 KAI-A	050001336	RSC50 2.0 KNAI-A	050001345
5000 RSC50/PLED	050001714	5000 RSC50 2.0/PLEDC	050001712
C55BO/1	055000090		
C55BG/1	055000091		
C55KAS	0550000370		
C55STR-W/9016	0550000907		
C55STR-GO/1035	0550000909		
C56M O	056000050		
C56M G	056000053		
C56M R	056000054		
C56B-O	056000401	C58BC-W2,1	058000621
C56B-G	056000402	C58BC-W2,1	058000621
C56B-R	056000403	C58BC-W2,1	058000621
C58M-O	058000300		
C58M-G	058000302		
C58M-R	058000303		
C58B-O	058000401	C58BC-W1,6	058000601
C58B-G	058000402	C58BC-W1,6	058000601
C58B-R	058000403	C58BC-W1,6	058000601
5938U/2T	059381062		
5990V1	059900001		
5990V3	059900003		
6600 M/62	066000062		
6600 M/175	066000175	6600 M/174	066000174
6600 M/222	066000222		
6600 M/311	066000311		
6600 M/423	066000423		
6600 M/424	066000424		
6600 M/583	066000583		
6600 M/852	066000852		
6600 M/856	066000856		
6600 M/857	066000857		
6600 M/871	066000871		
6600 M/878	066000878		
6600 M/881	066000881		
6888B/14	068880900		
6888B/3/8	068880910		
6888B/1/2	068880920		
7236BK 35	072360335	7243NC 35	072431635
7236BK 36	072360336	7243NC 36	072431636
7236BK 37	072360337	7243NC 37	072431637
7236BK 38	072360338	7243NC 38	072431638
7236BK 39	072360339	7243NC 39	072431639
7236BK 40	072360340	7243NC 40	072431640
7236BK 41	072360341	7243NC 41	072431641
7236BK 42	072360342	7243NC 42	072431642
7236BK 43	072360343	7243NC 43	072431643
7236BK 44	072360344	7243NC 44	072431644
7236BK 45	072360345	7243NC 45	072431645
7236BK 46	072360346	7243NC 46	072431646
7236BK 47	072360347	7243NC 47	072431647
7236BK 48	072360348	7243NC 48	072431648
7238WR 35	072380235		
7238WR 36	072380236		
7238WR 37	072380237		
7238WR 38	072380238		
7238WR 39	072380239		
7238WR 40	072380240		
7238WR 41	072380241		
7238WR 42	072380242		
7238WR 43	072380243		
7238WR 44	072380244		
7238WR 45	072380245		
7238WR 46	072380246		
7238WR 47	072380247		
7238WR 48	072380248		
7241BK 35	072411235	7246NB 35	072461635
7241BK 36	072411236	7246NB 36	072461636

7241BK 37	072411237	7246NB 37	072461637
7241BK 38	072411238	7246NB 38	072461638
7241BK 39	072411239	7246NB 39	072461639
7241BK 40	072411240	7246NB 40	072461640
7241BK 41	072411241	7246NB 41	072461641
7241BK 42	072411242	7246NB 42	072461642
7241BK 43	072411243	7246NB 43	072461643
7241BK 44	072411244	7246NB 44	072461644
7241BK 45	072411245	7246NB 45	072461645
7241BK 46	072411246	7246NB 46	072461646
7241BK 47	072411247	7246NB 47	072461647
7241BK 48	072411248	7246NB 48	072461648
7241CK 35	072411535	7241NC 35	072411635
7241CK 36	072411536	7241NC 36	072411636
7241CK 37	072411537	7241NC 37	072411637
7241CK 38	072411538	7241NC 38	072411638
7241CK 39	072411539	7241NC 39	072411639
7241CK 40	072411540	7241NC 40	072411640
7241CK 41	072411541	7241NC 41	072411641
7241CK 42	072411542	7241NC 42	072411642
7241CK 43	072411543	7241NC 43	072411643
7241CK 44	072411544	7241NC 44	072411644
7241CK 45	072411545	7241NC 45	072411645
7241CK 46	072411546	7241NC 46	072411646
7241CK 47	072411547	7241NC 47	072411647
7241CK 48	072411548	7241NC 48	072411648
7243FT 35	072430635	7243NFT 35	072430535
7243FT 36	072430636	7243NFT 36	072430536
7243FT 37	072430637	7243NFT 37	072430537
7243FT 38	072430638	7243NFT 38	072430538
7243FT 39	072430639	7243NFT 39	072430539
7243FT 40	072430640	7243NFT 40	072430540
7243FT 41	072430641	7243NFT 41	072430541
7243FT 42	072430642	7243NFT 42	072430542
7243FT 43	072430643	7243NFT 43	072430543
7243FT 44	072430644	7243NFT 44	072430544
7243FT 45	072430645	7243NFT 45	072430545
7243FT 46	072430646	7243NFT 46	072430546
7243FT 47	072430647	7243NFT 47	072430547
7243FT 48	072430648	7243NFT 48	072430548
7243CR 35	072430735		
7243CR 36	072430736		
7243CR 37	072430737		
7243CR 38	072430738		
7243CR 39	072430739		
7243CR 40	072430740		
7243CR 41	072430741		
7243CR 42	072430742		
7243CR 43	072430743		
7243CR 44	072430744		
7243CR 45	072430745		
7243CR 46	072430746		
7243CR 47	072430747		
7243CR 48	072430748		
7243BK 35	072431235	7248NB 35	072481635
7243BK 36	072431236	7248NB 36	072481636
7243BK 37	072431237	7248NB 37	072481637
7243BK 38	072431238	7248NB 38	072481638



# ARTIGOS ELIMINADOS - ARTIGOS DE SUBSTITUIÇÃO/RECOMENDADOS

	<b>ARTIGO ELIMINADO</b>
	<b>ARTIGO DE SUBSTITUIÇÃO</b>
	<b>ARTIGO RECOMENDADO</b>

7245BK 45	072451245	7245NB 45	072451645
7245BK 46	072451246	7245NB 46	072451646
7245BK 47	072451247	7245NB 47	072451647
7245BK 48	072451248	7245NB 48	072451648
7246BK 35	072461235	7246NB 35	072461635
7246BK 36	072461236	7246NB 36	072461636
7246BK 37	072461237	7246NB 37	072461637
7246BK 38	072461238	7246NB 38	072461638
7246BK 39	072461239	7246NB 39	072461639
7246BK 40	072461240	7246NB 40	072461640
7246BK 41	072461241	7246NB 41	072461641
7246BK 42	072461242	7246NB 42	072461642
7246BK 43	072461243	7246NB 43	072461643
7246BK 44	072461244	7246NB 44	072461644
7246BK 45	072461245	7246NB 45	072461645
7246BK 46	072461246	7246NB 46	072461646
7246BK 47	072461247	7246NB 47	072461647
7246BK 48	072461248	7246NB 48	072461648
7247BK 35	072471235	7247NB 35	072470635
7247BK 36	072471236	7247NB 36	072470636
7247BK 37	072471237	7247NB 37	072470637
7247BK 38	072471238	7247NB 38	072470638
7247BK 39	072471239	7247NB 39	072470639
7247BK 40	072471240	7247NB 40	072470640
7247BK 41	072471241	7247NB 41	072470641
7247BK 42	072471242	7247NB 42	072470642
7247BK 43	072471243	7247NB 43	072470643
7247BK 44	072471244	7247NB 44	072470644
7247BK 45	072471245	7247NB 45	072470645
7247BK 46	072471246	7247NB 46	072470646
7247BK 47	072471247	7247NB 47	072470647
7247BK 48	072471248	7247NB 48	072470648
7249GK 35	072490235	7248NB 35	072481635
7249GK 36	072490236	7248NB 36	072481636
7249GK 37	072490237	7248NB 37	072481637
7249GK 38	072490238	7248NB 38	072481638
7249GK 39	072490239	7248NB 39	072481639
7249GK 40	072490240	7248NB 40	072481640
7249GK 41	072490241	7248NB 41	072481641
7249GK 42	072490242	7248NB 42	072481642
7249GK 43	072490243	7248NB 43	072481643
7249GK 44	072490244	7248NB 44	072481644
7249GK 45	072490245	7248NB 45	072481645
7249GK 46	072490246	7248NB 46	072481646
7249GK 47	072490247	7248NB 47	072481647
7249GK 48	072490248	7248NB 48	072481648
7314AF 35	073140235	7316NG 35	073160635
7314AF 36	073140236	7316NG 36	073160636
7314AF 37	073140237	7316NG 37	073160637
7314AF 38	073140238	7316NG 38	073160638
7314AF 39	073140239	7316NG 39	073160639
7314AF 40	073140240	7316NG 40	073160640
7314AF 41	073140241	7316NG 41	073160641
7314AF 42	073140242	7316NG 42	073160642
7314AF 43	073140243	7316NG 43	073160643
7314AF 44	073140244	7316NG 44	073160644
7314AF 45	073140245	7316NG 45	073160645
7314AF 46	073140246	7316NG 46	073160646
7314AF 47	073140247	7316NG 47	073160647
7314AF 48	073140248	7316NG 48	073160648
7315AN 35	073150535	7320NA 35	073200535
7315AN 36	073150536	7320NA 36	073200536
7315AN 37	073150537	7320NA 37	073200537
7315AN 38	073150538	7320NA 38	073200538
7315AN 39	073150539	7320NA 39	073200539
7315AN 40	073150540	7320NA 40	073200540
7315AN 41	073150541	7320NA 41	073200541
7315AN 42	073150542	7320NA 42	073200542
7315AN 43	073150543	7320NA 43	073200543
7315AN 44	073150544	7320NA 44	073200544
7315AN 45	073150545	7320NA 45	073200545
7315AN 46	073150546	7320NA 46	073200546
7315AN 47	073150547	7320NA 47	073200547
7315AN 48	073150548	7320NA 48	073200548
7318AN 35	073180535	7321NA 35	073210535
7318AN 36	073180536	7321NA 36	073210536
7318AN 37	073180537	7321NA 37	073210537
7318AN 38	073180538	7321NA 38	073210538
7318AN 39	073180539	7321NA 39	073210539
7318AN 40	073180540	7321NA 40	073210540
7318AN 41	073180541	7321NA 41	073210541
7318AN 42	073180542	7321NA 42	073210542
7318AN 43	073180543	7321NA 43	073210543
7318AN 44	073180544	7321NA 44	073210544
7318AN 45	073180545	7321NA 45	073210545
7318AN 46	073180546	7321NA 46	073210546

7318AN 47	073180547	7321NA 47	073210547
7318AN 48	073180548	7321NA 48	073210548
7320NA 35	073200435	7320NA 35	073200535
7320NA 36	073200436	7320NA 36	073200536
7320NA 37	073200437	7320NA 37	073200537
7320NA 38	073200438	7320NA 38	073200538
7320NA 39	073200439	7320NA 39	073200539
7320NA 40	073200440	7320NA 40	073200540
7320NA 41	073200441	7320NA 41	073200541
7320NA 42	073200442	7320NA 42	073200542
7320NA 43	073200443	7320NA 43	073200543
7320NA 44	073200444	7320NA 44	073200544
7320NA 45	073200445	7320NA 45	073200545
7320NA 46	073200446	7320NA 46	073200546
7320NA 47	073200447	7320NA 47	073200547
7320NA 48	073200448	7320NA 48	073200548
7321NA 35	073210435	7321NA 35	073210535
7321NA 36	073210436	7321NA 36	073210536
7321NA 37	073210437	7321NA 37	073210537
7321NA 38	073210438	7321NA 38	073210538
7321NA 39	073210439	7321NA 39	073210539
7321NA 40	073210440	7321NA 40	073210540
7321NA 41	073210441	7321NA 41	073210541
7321NA 42	073210442	7321NA 42	073210542
7321NA 43	073210443	7321NA 43	073210543
7321NA 44	073210444	7321NA 44	073210544
7321NA 45	073210445	7321NA 45	073210545
7321NA 46	073210446	7321NA 46	073210546
7321NA 47	073210447	7321NA 47	073210547
7321NA 48	073210448	7321NA 48	073210548
7352A 38	073520038	7352B 38	073520138
7352A 39	073520039	7352B 39	073520139
7352A 40	073520040	7352B 40	073520140
7352A 41	073520041	7352B 41	073520141
7352A 42	073520042	7352B 42	073520142
7352A 43	073520043	7352B 43	073520143
7352A 44	073520044	7352B 44	073520144
7352A 45	073520045	7352B 45	073520145
7352A 46	073520046	7352B 46	073520146
7352A 47	073520047	7352B 47	073520147
7352A 48	073520048	7352B 48	073520148
7353Y 38	073530038	7353B 38	073530138
7353Y 39	073530039	7353B 39	073530139
7353Y 40	073530040	7353B 40	073530140
7353Y 41	073530041	7353B 41	073530141
7353Y 42	073530042	7353B 42	073530142
7353Y 43	073530043	7353B 43	073530143
7353Y 44	073530044	7353B 44	073530144
7353Y 45	073530045	7353B 45	073530145
7353Y 46	073530046	7353B 46	073530146
7353Y 47	073530047	7353B 47	073530147
7353Y 48	073530048	7353B 48	073530148
7355V 38	073550038	7355V 38	073550138
7355V 39	073550039	7355V 39	073550139
7355V 40	073550040	7355V 40	073550140
7355V 41	073550041	7355V 41	073550141
7355V 42	073550042	7355V 42	073550142
7355V 43	073550043	7355V 43	073550143
7355V 44	073550044	7355V 44	073550144
7355V 45	073550045	7355V 45	073550145
7355V 46	073550046	7355V 46	073550146
7355V 47	073550047	7355V 47	073550147
7355V 48	073550048	7355V 48	073550148
7376A 38	073760038		
7398T 35	073981335		
7398T 36	073981336		
7398T 37	073981337		
7398T 38	073981338		
7398T 39	073981339		
7398T 40	073981340		
7398T 41	073981341		
7398T 42	073981342		
7398T 43	073981343		
7398T 44	073981344		
7398T 45	073981345		
7398T 46	073981346		
7398T 47	073981347		
7398T 48	073981348		
7547BL XS	075470200	7552BL XS	075520300
7547BL S	075470201	7552BL S	075520301
7547BL M	075470202	7552BL M	075520302
7547BL L	075470203	7552BL L	075520303
7547BL XL	075470204	7552BL XL	075520304
7547BL XXL	075470205	7552BL XXL	075520305
7547BL XXXL	075470206	7552BL XXXL	075520306
7547G XS	075470300	7552G XS	075520400
7547G S	075470301	7552G S	075520401
7547G M	075470302	7552G M	075520402
7547G L	075470303	7552G L	075520403
7547G XL	075470304	7552G XL	075520404
7547G XXL	075470305	7552G XXL	075520405
7547G XXXL	075470306	7552G XXXL	075520406

7547N XS	075470400	7552N XS	075520500
7547N S	075470401	7552N S	075520501
7547N M	075470402	7552N M	075520502
7547N L	075470403	7552N L	075520503
7547N XL	075470404	7552N XL	075520504
7547N XXL	075470405	7552N XXL	075520505
7547N XXXL	075470406	7552N XXXL	075520506
7547AZ XS	075470500		
7547AZ S	075470501		
7547AZ M	075470502		
7547AZ L	075470503		
7547AZ XL	075470504		
7547AZ XXL	075470505		
7547AZ XXXL	075470506		
7547R XS	075470600		
7547R S	075470601		
7547R M	075470602		
7547R L	075470603		
7547R XL	075470604		
7547R XXL	075470605		
7547R XXXL	075470606		
7549BL XS	075490200	7553BL XS	075530300
7549BL S	075490201	7553BL S	075530301
7549BL M	075490202	7553BL M	075530302
7549BL L	075490203	7553BL L	075530303
7549BL XL	075490204	7553BL XL	075530304
7549BL XXL	075490205	7553BL XXL	075530305
7549BL XXXL	075490206	7553BL XXXL	075530306
7549G XS	075490300	7553G XS	075530400
7549G S	075490301	7553G S	075530401
7549G M	075490302	7553G M	075530402
7549G L	075490303	7553G L	075530403
7549G XL	075490304	7553G XL	075530404
7549G XXL	075490305	7553G XXL	075530405
7549G XXXL	075490306	7553G XXXL	075530406
7549N XS	075490400	7553N XS	075530500
7549N S	075490401	7553N S	075530501
7549N M	075490402		



# ARTIGOS ELIMINADOS - ARTIGOS DE SUBSTITUIÇÃO/RECOMENDADOS

	ARTIGO ELIMINADO
	ARTIGO DE SUBSTITUIÇÃO
	ARTIGO RECOMENDADO

7673NG L	076730003	7647GG L	076470013
7673NG XL	076730004	7647GG XL	076470014
7673NG XXL	076730005	7647GG XXL	076470015
7673NG XXXL	076730006	7647GG XXXL	076470016
7674NG S	076740001	7679GG S	076790011
7674NG M	076740002	7679GG M	076790012
7674NG L	076740003	7679GG L	076790013
7674NG XL	076740004	7679GG XL	076790014
7674NG XXL	076740005	7679GG XXL	076790015
7674NG XXXL	076740006	7679GG XXXL	076790016
7830ST XS	078300000	7820SG XS	078200100
7830ST S	078300001	7820SG S	078200101
7830ST M	078300002	7820SG M	078200102
7830ST L	078300003	7820SG L	078200103
7830ST XL	078300004	7820SG XL	078200104
7830ST XXL	078300005	7820SG XXL	078200105
7830ST XXXL	078300006	7820SG XXXL	078200106
7831ST XS	078310000	7821SG XS	078210100
7831ST S	078310001	7821SG S	078210101
7831ST M	078310002	7821SG M	078210102
7831ST L	078310003	7821SG L	078210103
7831ST XL	078310004	7821SG XL	078210104
7831ST XXL	078310005	7821SG XXL	078210105
7831ST XXXL	078310006	7821SG XXXL	078210106
7880SC XS	078800000		
7880SC S	078800001		
7880SC M	078800002		
7880SC L	078800003		
7880SC XL	078800004		
7880SC XXL	078800005		
7880SC XXXL	078800006		
7900V XS	079000500	7900G XS	079000800
7900V S	079000501	7900G S	079000801
7900V M	079000502	7900G M	079000802
7900V L	079000503	7900G L	079000803
7900V XL	079000504	7900G XL	079000804
7900V XXL	079000505	7900G XXL	079000805
7900V XXXL	079000506	7900G XXXL	079000806
7900V XXXXL	079000507	7900G XXXXL	079000807
7900P XS	079000600	7900G XS	079000800
7900P S	079000601	7900G S	079000801
7900P M	079000602	7900G M	079000802
7900P L	079000603	7900G L	079000803
7900P XL	079000604	7900G XL	079000804
7900P XXL	079000605	7900G XXL	079000805
7900P XXXL	079000606	7900G XXXL	079000806
7900P XXXXL	079000607	7900G XXXXL	079000807
7900B XS	079000700	7900G XS	079000800
7900B S	079000701	7900G S	079000801
7900B M	079000702	7900G M	079000802
7900B L	079000703	7900G L	079000803
7900B XL	079000704	7900G XL	079000804
7900B XXL	079000705	7900G XXL	079000805
7900B XXXL	079000706	7900G XXXL	079000806
7900B XXXXL	079000707	7900G XXXXL	079000807
7901G XS	079010800	7861G XS	078610800
7901G S	079010801	7861G S	078610801
7901G M	079010802	7861G M	078610802
7901G L	079010803	7861G L	078610803
7901G XL	079010804	7861G XL	078610804
7901G XXL	079010805	7861G XXL	078610805
7901G XXXL	079010806	7861G XXXL	078610806
7901G XXXXL	079010807	7861G XXXXL	078610807
7903P XS	079030600	7903G XS	079030800
7903P S	079030601	7903G S	079030801
7903P M	079030602	7903G M	079030802
7903P L	079030603	7903G L	079030803
7903P XL	079030604	7903G XL	079030804
7903P XXL	079030605	7903G XXL	079030805
7903P XXXL	079030606	7903G XXXL	079030806
7903P XXXXL	079030607	7903G XXXXL	079030807
7909V XS	079090500	7909G XS	079090800
7909V S	079090501	7909G S	079090801
7909V M	079090502	7909G M	079090802
7909V L	079090503	7909G L	079090803
7909V XL	079090504	7909G XL	079090804
7909V XXL	079090505	7909G XXL	079090805
7909V XXXL	079090506	7909G XXXL	079090806
7909V XXXXL	079090507	7909G XXXXL	079090807
7909P XS	079090600	7909G XS	079090800
7909P S	079090601	7909G S	079090801
7909P M	079090602	7909G M	079090802
7909P L	079090603	7909G L	079090803
7909P XL	079090604	7909G XL	079090804
7909P XXL	079090605	7909G XXL	079090805
7909P XXXL	079090606	7909G XXXL	079090806

7909P XXXXL	079090607	7909G XXXXL	079090807
7909B XS	079090700	7909G XS	079090800
7909B S	079090701	7909G S	079090801
7909B M	079090702	7909G M	079090802
7909B L	079090703	7909G L	079090803
7909B XL	079090704	7909G XL	079090804
7909B XXL	079090705	7909G XXL	079090805
7909B XXXL	079090706	7909G XXXL	079090806
7909B XXXXL	079090707	7909G XXXXL	079090807
7940 XXXL	079400006		
7940 XXXXL	079400007		
7970 XS	079700000	7971B XS	079710200
7970 S	079700001	7971B S	079710201
7970 M	079700002	7971B M	079710202
7970 L	079700003	7971B L	079710203
7970 XL	079700004	7971B XL	079710204
7970 XXL	079700005	7971B XXL	079710205
7970 XXXL	079700006	7971B XXXL	079710206
7971L XS	079710100	7971B XS	079710200
7971L S	079710101	7971B S	079710201
7971L M	079710102	7971B M	079710202
7971L L	079710103	7971B L	079710203
7971L XL	079710104	7971B XL	079710204
7971L XXL	079710105	7971B XXL	079710205
7971L XXXL	079710106	7971B XXXL	079710206
7978L XS	079780100	7978B XS	079780200
7978L S	079780101	7978B S	079780201
7978L M	079780102	7978B M	079780202
7978L L	079780103	7978B L	079780203
7978L XL	079780104	7978B XL	079780204
7978L XXL	079780105	7978B XXL	079780205
7978L XXXL	079780106	7978B XXXL	079780206
7979 S	079790001	7978B S	079780201
7979 M	079790002	7978B M	079780202
7979 L	079790003	7978B L	079780203
7979 XL	079790004	7978B XL	079780204
7979 XXL	079790005	7978B XXL	079780205
7979 XXXL	079790006	7978B XXXL	079780206
7984EG	079840520	7984G	079840525
8080FM 4	080800204		
8080FM 5	080800205	8581 5	085810005
8080FM 6	080800206	8581 6	085810006
8080FM 7	080800207		
8080FM 8	080800208		
8082 4	080820004		
8082 5	080820005		
8082 6	080820006		
8082 7	080820007		
8082 8	080820008		
8083 3	080830003	8583GS 3	085830003
8083 4	080830004	8583GS 4	085830004
8083 5	080830005	8583GS 5	085830005
8083 6	080830006	8583GS 6	085830006
8083 8	080830008	8583GS 8	085830008
8114 8	081140008	8514M 8	085140008
8114 10	081140010	8514M 10	085140010
8114 12	081140012	8514M 12	085140012
8114 14	081140014	8514M 14	085140014
8114 16	081140016	8514M 16	085140016
8114 18	081140018	8514M 18	085140018
8114 20	081140020	8514M 20	085140020
8114 22	081140022	8514M 22	085140022
8116 6	081160006	8514S 6	085140106
8116 8	081160008	8514S 8	085140108
8116 10	081160010	8514S 10	085140110
8116 12	081160012	8514S 12	085140112
8116 14	081160014	8514S 14	085140114
8116 16	081160016	8514S 16	085140116
8116 18	081160018	8514S 18	085140118
8116 20	081160020	8514S 20	085140120
8116 22	081160022	8514S 22	085140122
8181 6/S4	081810906	8181 6/B4	081810916
8182 8,5/S2	081821985	8182 8,5/B2	081821985
VP-LD	088880358		
8889PD/7	088890427		
8889CD/7	088890437		
9500TL S	095000051		
9500TL M	095000052		
9500TL L	095000053		
9500TL XL	095000054		
9500TL XXL	095000055		
9501TL S	095010051		
9501TL M	095010052		
9501TL L	095010053		
9501TL XL	095010054		
9501TL XXL	095010055		
9502TL S	095020051		
9502TL M	095020052		
9502TL L	095020053		
9502TL XL	095020054		
9502TL XXL	095020055		
9505TL S	095050051		

9505TL M	095050052		
9505TL L	095050053		
9505TL XL	095050054		
9505TL XXL	095050055		
9526P	095260010	9526MC	095260020
9537TL S	095370051		
9537TL M	095370052		
9537TL L	095370053		
9537TL XL	095370054		
9537TL XXL	095370055		
9542G XXXL	095420017		
9542AT S	095420072		
9542AT M	095420073		
9542AT L	095420074		
9542AT XL	095420075		
9542AT XXL	095420076		
9542AT XXXL	095420077		
9561V 2,5	095610200		
9590B	095900000		
9592MB	095920060		
9592M/50	095920100		
9593 S	095930200		
9741 (3)	097412040		
9743 (1)	097430050		
9743 (2)	097431050		
9743 (3)	097432050		
9745 (3)	097452040		
9746 (3)	097462040		
9749 (2)	097491040		
9749 (3)	097492040		
9755 (3)	097552040		
9765 (3)	097652040		
9775 (2)	097751040		
9775 (3)	097752040		
9841R P200 (3)	098412020		
9841N P200 (3)	098412100		
9851 T5 (3)	098512500		
9899 920C17	098990137	9899 920C17	098990147
C99V1	099000250		
C99PC	099000491		
C99C-V3	099000496		
C99P12-V0	099000499		
11001H 230X3,2	110010733	11001 230X3,2	110010233
11003 115X2,5	110030117	11001 115X3,2	110010118
11003 125X2,5	110030127	11001 125X3,2	110010128
11003 180X2,5	110030182		
11003 230X2,5	110030232	11001 230X3,2	110010233
11011 180X6,5	110110180		
11011H 115X6,5	110110615	11011 115X6,5	110110115
11011H 125X6,5	110110625	11011 125X6,5	110110125
11011H 180X6,5	110110680		
11011H 230X6,5	110110730	11011 230X6,5	110110230
11018 300X2,5	110180030		
11018 350X3,0	110180035		
11018 400X3,2	110180040		
11019 300X3,8	110190030		
11019 350X4,2	110190035		
11019 400X4,5	110190040		
11021 180X3,2	110210183		
11024 230X2,0	110240230	11038 2,0-22,23	110380022
11031 1,0-6	110310006		
11031 1,0-10	110310010		
11031 1,6-10	110310020		
11			





# ARTIGOS ELIMINADOS - ARTIGOS DE SUBSTITUIÇÃO/RECOMENDADOS

ARTIGO ELIMINADO
ARTIGO DE SUBSTITUIÇÃO
ARTIGO RECOMENDADO

11101 30X10	111010034	11101 30X30	111010035
11101 32X20	111010037		
11101 40X25	111010043	11101 40X20	111010042
11101 50X15	111010051	11101 50X25	111010052
11102 8X20	111020008		
11102 10X15	111020010	11101 10X15	111010011
11102 10X30	111020020	11101 10X32	111010014
11102 12X15	111020022		
11102 15X15	111020035	11101 15X15	111010019
11102 15X30	111020040	11101 16X32	111010022
11102 20X30	111020060	11101 20X30	111010027
11105 20X65	111050020		
11106 6X10	111060006		
11110 10X15	111100010		
11115 10X20	111150010		
11116 22X70	111160022	11116 20X50	111160020
11120 6X13	111200006		
11121 6X25	111210007		
11121 12X20	111210012		
11121 20X25	111210020		
11121 25X25	111210025		
11121 30X30	111210030		
11125 6X20	111250006		
11125 25X25	111250025		
11125 30X50	111250030		
11125 40X40	111250040		
11130 6X6	111300006		
11130 8X8	111300008		
11130 10X10	111300010		
11132 10X10	111320010		
11132 15X15	111320015		
11132 20X20	111320020		
11135 30X6	111350030		
11135 40X10	111350040		
11140 20X30	111400020		
11140 25X25	111400025		
11140 30X30	111400030		
11140 50X10	111400050		
11141 20X40	111410020		
11141 30X40	111410030		
11141 40X40	111410040		
11145 20X30	111450020		
11145 25X50	111450025		
11200A 40	112000004	11202A 40	112020004
11200A 60	112000006	11202A 60	112020006
11200A 80	112000008	11202A 80	112020008
11200A 120	112000012	11202A 120	112020012
11200B 40	112000104	11202B 40	112020104
11200B 60	112000106	11202B 60	112020106
11200B 80	112000108	11202B 80	112020108
11202C 40	112020204		
11202C 60	112020206		
11208A 40	112080004	11204A 40	112040004
11208A 60	112080006	11204A 60	112040006
11208B 40	112080104	11204B 40	112040104
11208B 60	112080106	11204B 60	112040106
11212A 40	112120004	11214A 40	112140004
11212A 60	112120006	11214A 60	112140006
11212A 80	112120008	11214A 80	112140008
11212A 120	112120012	11214A 120	112140012
11212B 40	112120104		
11212B 60	112120106		
11212B 80	112120108		
11214B 40	112140104	11216B 40	112160104
11214B 60	112140106	11216B 60	112160106
11214B 80	112140108	11216B 80	112160108
11214C 40	112140204		
11214C 60	112140206		
11218A 40	112180004	11216A 40	112160004
11218A 60	112180006	11216A 60	112160006
11218B 40	112180104	11216B 40	112160104
11218B 60	112180106	11216B 60	112160106
11220A 40	112200004		
11220A 60	112200006		
11220A 80	112200008		
11220A 120	112200012		
11220B 40	112200104		
11220B 60	112200106		
11220B 80	112200108		
11222B 40	112220104		
11222B 60	112220106		
11222B 80	112220108		
11230A 40	112300004	11234A 40	112340004
11230A 60	112300006	11234A 60	112340006
11230A 80	112300008	11234A 80	112340008
11230A 120	112300012	11234A 120	112340012

11230B 40	112300104		
11230B 60	112300106		
11232A 40	112320004	11234A 40	112340004
11232A 60	112320006	11234A 60	112340006
11232A 80	112320008	11234A 80	112340008
11232A 120	112320012	11234A 120	112340012
11240A 40	112400004	11246A 40	112460004
11240A 60	112400006	11246A 60	112460006
11240B 40	112400104		
11240B 60	112400106		
11242A 40	112420004	11248A 40	112480004
11242A 60	112420006	11248A 60	112480006
11242B 40	112420104		
11242B 60	112420106		
11248B 40	112480104		
11248B 60	112480106		
11259 125	112590125		
11266 20-40	112660004	11266 20-60	112660006
11266 40-80	112660028	11266 40-60	112660026
11271A C	112710001		
11271A M	112710002		
11271A F	112710003		
11271A VF	112710004		
11271B C	112710011		
11271B M	112710012		
11271B F	112710013		
11271B VF	112710014		
11271C C	112710021		
11271C M	112710022		
11271C F	112710023		
11271C VF	112710024		
11276A 60	112760006		
11276A 80	112760008		
11276A 120	112760012		
11276B 60	112760016		
11276B 80	112760018		
11276B 120	112760022		
11276C 60	112760036		
11276C 80	112760038		
11276C 120	112760042		
11300A 40	113000004		
11300A 60	113000006		
11300A 80	113000008		
11300A 120	113000012		
11300A 180	113000018		
11300A 220	113000022		
11300B 40	113000104		
11300B 60	113000106		
11300B 80	113000108		
11300B 120	113000112		
11300B 180	113000118		
11300B 220	113000122		
11300C 40	113000204		
11300C 60	113000206		
11300C 80	113000208		
11300C 120	113000212		
11300C 180	113000218		
11300D 40	113000304		
11300D 60	113000306		
11300D 80	113000308		
11300D 120	113000312		
11300D 180	113000318		
11300D 220	113000322		
11300E 40	113000404		
11300E 60	113000406		
11300E 80	113000408		
11300E 120	113000412		
11300F 40	113000504		
11300F 60	113000506		
11300F 80	113000508		
11300F 120	113000512		
11300F 180	113000518		
11300F 220	113000522		
11300G 40	113000604		
11300G 60	113000606		
11300G 80	113000608		
11320 C	113200006		
11320 M	113200008		
11320 F	113200012		
11320 VF	113200024		
11411 40	114110004		
11411 60	114110006		
11411 80	114110008		
11411 120	114110012		
11411 240	114110024		
11415B C	114150106		
11415B M	114150108		
11415B F	114150112		
11415B VF	114150124		
11420B C	114200106		
11420B M	114200108		
11420B F	114200112		

11420B VF	114200124
11431 C	114310006
11431 M	114310008
11431 F	114310012
11431 VF	114310024
11440A 24	114400024
11440A 36	114400036
11440A 60	114400060
11440A 120	114400120
11440B 24	114400224
11440B 36	114400236
11440B 60	114400260
11440B 120	114400320
11440C 24	114400424
11440C 36	114400436
11440C 60	114400460
11440C 120	114400520
11450A 24	114500024
11450A 36	114500036
11450A 60	114500060
11450A 120	114500120
11450B 24	114500224
11450B 36	114500236
11450B 60	114500260
11450B 120	114500320
11450C 24	114500424
11450C 36	114500436
11450C 60	114500460
11450C 120	114500520
11488PF 115	114880115
11488PF 125	114880125
11488PF 180	114880180
11491 40	114910004
11491 60	114910006
11491 80	114910008
11491 100	114910010
11491 120	114910012
11491 150	114910015
11491 180	114910018
11491 220	114910022
11491 240	114910024
11491 320	114910032
11491 400	114910040
11493 40	114930004
11493 60	114930006
11493 80	114930008
11493 100	114930010
11493 120	114930012
11493 150	114930015
11493 180	114930018
11493 220	114930022
11493 240	114930024
11493 320	114930032
11493 400	114930040
11495 40	114950004
11495 60	114950006
11495 80	114950008
11495 100	114950010
11495 120	114950012
11495 180	114950018
11495 240	114950024
11495 400	114950040
11498 M	114980008
11498 F	114980012
11498 VF	114980015
11498 UF	114980018



Abocardador para tubos	32
Abraçadeiras	590÷593
Abraçadeiras em velcro	593
Acessórios para carros, gavetas e painéis	569÷571
Acessórios para tensores aço inox	699÷705
Adesivo de montagem	575
Alavancas / pés-de-cabra	121÷122; 213; 302
Alicate de dobrar chapa	130
Alicate de furar chapa	130
Alicate para abraçadeiras em nylon	594
Alicate torce-arama com retorno automático	231
<b>Alicate vazador</b>	<b>232</b>
<b>Alicates ajustáveis</b>	<b>128÷131; 282; 288; 303</b>
Alicates de corte diagonal	131; 282; 288; 294
<b>Alicates de corte para eletrônica</b>	<b>141÷142</b>
<b>Alicates de freios</b>	<b>127÷128; 170; 288; 302</b>
Alicates de pontas longas e extralongas	125; 138÷140; 282÷283; 289; 302
Alicates de pressão	129÷131; 185; 288
Alicates de rebitar e rebites	221÷222; 232; 335
Alicates e ferramentas para descarnar fio	136
Alicates para cravar terminais	290; 305; 585÷587
<b>Alicates para eletrônica</b>	<b>140÷141</b>
Alicates universais	137÷138; 282; 289
Almofada insuflável de elevação	237
Almotolias	223÷224
Apalpa-folgas	213; 290
<b>Aparafusadoras dinamométricas</b>	<b>60; 122</b>
Argolas de elevação	681÷684
Armários para ferramentas	393
Armários para ferramentas, chapa metálica	438÷440; 461÷462; 485÷486
Arrancadores de baterias	186÷188
Aspiradores de líquidos e sólidos	318÷319
Bancadas de trabalho	392÷414; 421÷423
Banco giratório	254÷255
Barras dinamométricas	62; 66÷68
Beta Abrasives	579÷584
Beta BM	588÷594
Beta Chemicals	572÷578
Beta Collection	715÷726
Bloqueante	574
Bloqueante	573
Bloqueante líquido	574
Bolsa para ferramentas com cinto	346
Bomba de massa manual	222; 290
<b>Bomba dessoladora</b>	<b>246</b>
Bomba manual para bidões	248
Bombas de massa	223
Bombas hidráulicas	161
Brocas cilíndricas	36÷40
Brocas cónicas	41
Brocas especiais para soldadores	41
Brocas para furar, roscar e escarear	47
Brocas, fresas craneanas e acessórios	51÷52
Buris	10
Busca-pólos	148
Caixa de velocidades	85
Caixas para ferramentas	353

**Caixas para ferramentas**
**295; 352÷355**

Caixas para ferramentas industriais	376
Caixas para ferramentas portáteis	359÷360; 382
Calçado de segurança	624÷649
Câmara termográfica	231
Capas para blocos de ferramentas	383
Carregadores de baterias	188÷193
Carro de ferramentas tipo trolley rebatível	389; 358
Carros para caixas de ferramentas	360
Carros para ferramentas	296; 362÷372; 378÷382; 427÷428; 450÷452; 475÷476;
Cerra-cabos	677÷678
Cerra-cabos terminais	590
Chave de fendas Evox-E elétrica	146
Chaves ajustáveis	24÷25; 286; 294; 300
Chaves anti-faísca para válvulas de segurança	302
Chaves com roquete	17; 25÷28; 287; 299
Chaves de bocas simples e duplas	13÷15; 63÷64; 275; 279; 286; 298
Chaves de cachimbo 6 faces / 12 faces	112÷113; 287; 302
Chaves de caixa articuladas duplas	15
Chaves de caixa sextavadas com punho	114; 281
Chaves de caixa sextavadas com punho em T para parafusos de perfil Torx®	114÷115
Chaves de caixa tubulares	112÷113
Chaves de caixa, acessórios e jogos, 1"	110
Chaves de caixa, acessórios e jogos, 1/2"	99÷108; 281; 301
Chaves de caixa, acessórios e jogos, 1/4"	86÷93
Chaves de caixa, acessórios e jogos, 3/4"	108÷110; 301
Chaves de caixa, acessórios e jogos, 3/8"	93÷99; 280÷281; 300
Chaves de fendas angulares	147
Chaves de fendas BetaEVOX	143÷145
Chaves de fendas BetaGrip	150÷153
Chaves de fendas BetamaX	155÷157
Chaves de fendas com guia prensili	147
Chaves de fendas reversíveis	153÷154
Chaves de impacto, acessórios e jogos	69÷78
Chaves de luneta	15÷17; 25÷28; 64÷65; 171; 177; 181; 279; 286; 298÷299
Chaves de luneta para parafusos de andaimes	17; 286; 299
Chaves de lunetas abertas	17
Chaves de pancada	14÷15; 298÷299
Chaves de parafusos com ponta de aço	147
Chaves de unha	23÷24; 64; 300
Chaves e barras dinamométricas	57÷69; 287;
Chaves em T com 3 pontas macho sextavadas para parafusos de perfil Torx®	115÷116; 281; 302
Chaves macho sextavadas com perfil XZN®	23
Chaves macho sextavadas para parafusos de perfil Torx®	18÷21; 293; 299÷300
Chaves macho sextavadas para parafusos de perfil Torx®, com punho	21÷22; 286; 294
Chaves mistas boca/luneta	11÷13; 25÷27; 285; 287; 293; 298
Chaves para operadores de painéis de controlo	204
Chaves para tubos	33÷34; 287; 294; 300
Chaves pé de galo quadra fêmea de 3/8"	96
Cola instantânea	576
Comparadores	205÷207
Compassos	208
Conjunto de mala de ferramentas e acessórios	356÷358
Contador de litros digital para óleo	249
Conta-fios	213
<b>Controlador de binário eletrónico com transdutor Dynatester</b>	<b>69</b>
Correntes de delimitação e postes em plástico	667
Corta-cabos	136; 282; 288





Corta-cabos para serviços pesados	133
Corta-parafusos	132; 303
Corta-tubos	29÷30
Curva-tubos	35
Desandadores de machos e caçonetes	46÷51
Desandadores de percussão	156÷157
Desbloqueador lubrificante em spray	576
Detergentes	577÷578
Diferencial de corrente manual	692÷693
Discos abrasivos	580÷581
Discos lamelares	582÷584
Eixo anti-faísca	305
Elevadores para bicicletas	274÷275
Enrolador de cabo elétrico com gambiarra fluorescente	242÷244
Enrolador de tubo para ar comprimido ou água fria	339
Escopros planos	10; 124; 212; 285; 293; 297; 305
Escovas	220
Espátulas	220; 295; 305
Espelhos de inspeção	214
Espuma de poliuretano	575
Esquadros	207÷208
Esteiras	256
Esticadores	710÷712
Estropos de elevação	706÷709
Expositores para pontos de venda	610÷623
Extrator de fio de nylon	587
Extrator de fluídos	248
Extrator de porcas e parafusos	169
<b>Extratores</b>	<b>194÷203; 232; 272; 276</b>
Extratores de 2 pernas	194÷195; 197; 203
Extratores de 3 pernas	196÷197; 203
Extratores de cones Morse	43
Extratores dos cubos e tambores de rodas	197÷198
Extratores hidráulicos	203
Ferramenta rebarba-tubos	31
Ferramentas anti-faísca	297÷305
Ferramentas antiqueda	285÷291
Ferramentas elétricas	306÷319
Ferramentas elétricas	315÷318
Ferramentas em aço inox	292÷296
Ferramentas isoladas 1000V	278÷284
Ferramentas para bicicletas	273÷277
Ferramentas para canalização	28÷35
Ferramentas para motocicletas	267÷272
Ferramentas pneumáticas e acessórios	320÷342
Ferramentas sem fio	306÷314
Ferro de soldar tubos e uniões em plástico	28
Ferro de soldar tubos e uniões em plástico de grandes dimensões	28
Ferros de soldar	245÷246
Fita de fricção	594
Fitas-métricas	210; 290
Furadores	214
Gama blister	595÷609
Ganchos de elevação	692
Goniómetros	208
Grampos	203
Grampos	203÷204
Guarda-cabos	679÷701



Guinchos manuais e acessórios	694; 698
Holofote LED	240÷241
Indicadores do ângulo de aperto	61
Inserts de 4mm	148
Jogos de ferramentas	492÷543
Jogos de ferramentas em módulos	544÷569
Kit reparação de plástico	163
Lamelas	584
Lanternas	238
Lanternas / gambiarras	238÷242
Lápis de carpinteiro	209
Limas	159; 215÷219
Lingas de corrente	685÷689
Luvas isolantes	284
Machos manuais e jogos	44÷47
Machos, caçonetes e jogos	46÷51
Magnetizador/desmagnetizador	142
<b>Mala para ferramentas tipo mochila</b>	<b>350÷351</b>
<b>Malas para ferramentas</b>	<b>346; 350÷353</b>
Malas para ferramentas	344÷348
Malas para ferramentas tipo trolley	372÷374; 387÷391
Malas para ferramentas tipo trolley	347÷348; 351; 353; 385÷386
Malhos	166; 304
Manilhas direitas	679÷681
Manómetros para tubos com várias camadas	31
Marretas	166; 304
Martelos	160; 164÷166; 289; 295; 303÷304
Martelos com batentes plásticos	167; 289÷290; 304
Máscara de soldadura	246
Massa lubrificante multiusos em spray	576÷577
Medidor de distância laser	210
Medidor de raios	213
Micro-chaves para parafusos	146; 148÷149
Micrómetros	206
Mobiliário para Oficina	416÷491
Módulos maleáveis para ferramentas	544÷569
Molas helicoidais em aço inoxidável	46÷47
Mós montadas abrasivas	581÷582
Multímetros	228÷229; 290
Multiplicadores de binário	54÷56
<b>Navalhas</b>	<b>235÷236; 284; 291; 305</b>
Níveis de bolha	211÷212
Óculos de proteção	668
Oleador tipo caneta	224
Painéis para ferramentas	396
Paquímetros	205÷206
Pás anti-faísca	305
Pesca peças magnético	214
Pesca-peças magnético	213
Picaretas anti-faísca	305
Pinça amperimétrica	229
Pinças	124÷125; 282
Pincéis	220
Pistola de colagem a quente	318
Pistola de óleo	249
<b>Pistolas de ar quente</b>	<b>318</b>
Pistolas de pintura	339
Pistolas para isolantes	222; 336

Plataforma de carga elétrica	308
Plataforma em alumínio	233
Pontas e porta-pontas	79÷83; 153; 280
Ponteiros para pedreiro	40; 212
Posto de trabalho móvel	375
<b>Prensas hidráulicas para extratores</b>	<b>203</b>
Produtos elétricos	588÷594
Punções	10; 297
Punções de bico	9
Quebra-porcas	213
Raspadores	214÷215; 234
Réguas graduadas	209
Reparação de veículos	118÷124; 130÷131; 158÷164; 169÷202; 220÷233; 247÷252; 257÷266
Revestimentos isolantes	594
Riscadores	209
Robur acessórios para cabos	670÷714
Saca-molas	219
Saca-troços	9
Selante acrílico	575
Selante de silicone	575÷576
Serra para madeira	219
Serrote e folhas de serra	219
Silicone em spray	577
Sinais de alerta em alumínio	667
Spray de limpeza	577
Spray descongelante	578
Spray impermeabilizante	578
Suporte de ferramentas magnético	233
Suporte para chaves de impacto	326
Suporte para rolos de papel	370
Suportes para garrafas	370
Tacómetro digital	230
Tacómetros ambientais	231
Talhadeira extra-chata com cortante direito	159
Tanques de limpeza ultrassônicos	252÷253
Tapete isolante	284
Tapete para bancada de trabalho	269; 725÷726
Tensores	671÷676
Terminais pré-isolados	589
Termómetros	230÷231
Tesoura com roquete para tubos PVC	30÷31
Tesouras	134
<b>Tesouras</b>	<b>135÷136; 236÷237; 305</b>
Tesouras para eletricistas	135÷136; 282; 288
Torno de bancada para tubos	35
Tornos paralelos de bancada	204
Traçador de linhas	213
Transferidor de ângulos	208
Turquês para cofragens	132
Vazador de juntas	133÷134
Vedante de roscas	573
Ventosas	232
Verificador de tensão	185
Vestuário de trabalho	650÷669
Videoscópio eletrônico	121
<b>X-ato</b>	<b>233÷236; 290</b>
Zinco em spray	578



# Automotive



Alavanca para bloquear/desbloquear caixas de velocidades DSG	169
Alavanca para extração do terminal do braço oscilante da suspensão e dos amortecedores	202
Alicate de pressão com corrente para tubos de escape	176
Alicate para abraçadeiras	175
Alicate para agramos de estofos auto	232
Alicate para anéis de segurança	170
Alicate para as juntas de afinação das válvulas	170
Alicate para as molas dos travões de tambor	173÷174
Alicate para cachimbos de velas	176
Alicate para cavilhas	177
Alicate para ligações rápidas de tubos de combustível	179
Alicate para pesos de calibragem	124
Alicate para remoção de relés	184÷185
Alicate para tampas de plástico de porcas de rodas	123
Alinhadores de embraiagem	169
Aparelho de extração do líquido de travões	173
Aparelho de teste de baterias e sistemas de recarga/arranque	193
Aparelho para deteção de fugas em sistemas de refrigeração	227
Aparelhos de soldar por pontos com rodas	162
Apoio para motociclos	268
Apoios telescópicos	233
Armações flexíveis com lima de chapeiro	159
Arrancadores de baterias	186÷188
Bancada com rodas para caixas de velocidades/transmissões	391
Barra de torção de impacto para cubos de roda	77
Bomba manual para regulação e controlo de injetores Diesel	121
Capas para rodas	123
Carregadores de baterias	188÷193
Chaves de caixa para injetores de motores Diesel	119
Chaves de caixa para porcas de cubos de rodas	122
Chaves de caixa para sonda Lambda	119
Chaves de cruz para porcas de rodas	123
Chaves de gancho para molas	168
Chaves de impacto para porcas de rodas	71÷73
Chaves de impacto para porcas de rodas Isuzu	76
Chaves de pancada para instalação de rolamentos cónicos e vedantes	202
Chaves em T com cardan para velas	118
Chaves para bujões de óleo	183÷184
Chaves para depósitos de combustível	179
Chaves para filtros de óleo	180÷183



Chaves para filtros de óleo diesel	182
Chaves para injetores	171
Chaves para remoção/instalação braços de direção	202
Chaves para sensores de temperatura	119
Cintas para segmentos	170
Colheres angulares curvas	159
Compressómetro digital	171
Compressómetros para motores a gasolina e Diesel	121
Compressores de molas de válvulas	170
Densímetro para líquido anticongelante, corpo em vidro	226
Densímetro para líquido das baterias, corpo em vidro	226
Destalonadores de pneus	338
Detetor de sinal	230
Elevador para rodas	258
Encontradores	158÷159
Escovas em aço para limpeza de terminais e bornes de baterias	220
Espátulas para reparação auto, em aço inoxidável	159
Estabilizadores de voltagem	194
Estação de carregamento automático para ar condicionado	251
Estação de manutenção para caixa de velocidades automáticas	250÷251
Estetoscópio	194
Estrado	256÷257
Extrator de juntas	198
Extrator de rótulas homocinético	202
Extratores de injetores elétricos common rail diesel	119
Extratores de rótulas	201
Extratores de velas de incandescência danificadas	120
Ferramenta para desmontagem/montagem de pneus	121÷122, 276
Ferramenta para remoção de frisos das portas	232
Ferramentas para lavagem auto interior/exterior	247, 254, 339
Ferramentas para remoção de vidros de viaturas	232
Ferramentas para válvulas de pneus	122÷123
Folha de alumínio moldável, com revestimento em borracha	226
Funil em plástico	224÷225, 305
Grampos para oclusão de tubos	179
Grua hidráulica rebatível	260
Instrumento digital de medição da profundidade das ranhuras dos pneus	213
Jogo de ferramentas para extração e colocação de sinoblocos	202
Jogo de escareadores para limpeza do alojamento dos injetores	120
Jogo de ferramentas para remoção de terminais elétricos	185
Jogo de ferramentas para rodar e recuar êmbolos de travões	174
Kit abertura e cravagem de correntes	271
Kit para enchimento de filtros de óleo diesel	178
Macaco de fossas hidráulico	260
Macaco de garrafa hidráulico	258



Macaco de rodas hidráulico	263÷264
Macaco e dispositivo posicionamento para rodas de pesados	258
Macaco hidropneumático	265÷266
Máquinas de limpeza de componentes do motor	254
Martelos com pena	160
Paquímetros para discos e tambores de travões	205
Pinos-guia macho para rodas	123
Porta-paletes manual	266
Preguiças	258÷259
Prensa hidráulica	261÷263
Prensa pneumática para molas de amortecedores	199÷200
Proteção frontal para veículo	255
Punções para instalação de sensores de estacionamento	163
Punho de encher pneus	338
Recuperador de óleo	247÷248
Reservatório coletor de fluidos	248
Reservatórios para líquido de baterias	225
Retificador de válvulas pneumático	170
Suporte para motores	259
Tanque de limpeza de componentes	253÷254
Tira mossas	160÷161
Tira-mossas pneumáticos	161
Trolley inferior para veículos	257
Trolley multiusos	387
Verificador de tensão	185







# ÍNDICE ALFANUMÉRICO

<b>1</b>		1010BM	126	1067	131	1120ARL - ARG	134	1150K	602
		1010MQ	282	1068	161	1122	134	1150MQ	282
100	24	1031/S4	127	1077	131	1122 - 1125MOL	134	1153	138
100/KIT	24	1032	127	1078	131	1122K	601	1153INOX	295
110BA	300	1032BA	302	1080D	131	1122L	134	1162	138
110MQ	279	1032HS	288	1081	131	1123	134	1162BA	303
111CM	25	1032K	600	1082	131	1123K	601	1162BM	139
111E	24	1033	127	1082BA	303	1124	134	1162BMK	603
111E/D3	24	1033K	600	1082BM	131	1124K	601	1162G	139
111E-HS	286	1034	127	1082BM-HS	288	1125	134	1162GBM	139
111EN	24	1034HS	288	1082BMK	601	1126	134	1162GBMK	603
111ER	24	1034K	600	1082G	131	1127	135	1162GK	602
111INOX	294	1034L	127	1082GBM	131	1128BAX	135	1162K	602
120	25	1036	127	1082GBMK	601	1128BAX-HS	288	1162MQ	282
120/B6N	25	1036BA	302	1082GK	601	1128BM	136	1164	139
123/K4	25	1036HS	288	1082INOX	294	1128BMX	135	1164BM	139
123E1/4	25	1036K	600	1082K	601	1128BMX/F	135	1164BMK	603
123Q1/2	25	1037	127	1082MQ	282	1128BSX	135	1164K	603
123Q1/4	25	1037K	600	1084	131	1128FX	135	1164MQ	282
123Q3/8	25	1038	127	1084BM	132	1128FXS	136	1166	139
141	25	1038HS	288	1084BMK	601	1128MQ	282	1166BA	303
141/B	25	1038K	600	1084G	131	1130BMX	136	1166BM	139
141/S	25	1039	128	1084GBM	132	1131CK	136	1166BM-HS	289
142	26	1044N	128	1084GBMK	601	1132	136	1166BMK	603
142/B	26	1044NK	600	1084GK	601	1132BM	136	1166G	139
142/S	26	1046BA	303	1084K	601	1132BM-HS	288	1166GBM	139
142/SC9I-E	12	1047	128	1084MQ	282	1132BMK	602	1166GBMK	603
142AS	26	1048BM	128	1088	132	1132K	602	1166GK	603
142AS/S	26	1048BM-HS	288	1088BM	132	1132MQ	282	1166K	603
142C	27	1048INOX	294	1088BM-HS	288	1133	136	1166MQ	282
142C/A	27	1048MQ	282	1088BMK	601	1133RL	136	1168	139
142HS	287	1048N	128	1088K	601	1135	136	1168BM	140
142K	597	1048N/D3	128	1088MQ	282	1137BA	303	1168BM-HS	289
142MC	26	1048NK	600	1092V	132	1137BA/RC	303	1168BMK	603
142MC/SC9I-E	26	1048VN	128	1094V	132	1142BM	136	1168G	139
142SN	27	1048VNK	600	1095N	132	1142BMK	602	1168GBM	140
142SN/S	27	1050	129	1096	132	1142MQ	282	1168GBMK	603
142SN/SC9	27	1051	129	1096K	601	1143	136	1168GK	603
186	27	1051GM	129	1098	132	1143R	136	1168K	603
187	27	1051L	129	1098K	601	1144D	136	1168MQ	283
187/B5	27	1051XL	129	1098PL	132	1144D/RG	136	1169/D3	140
192	27	1052	129	1098PLK	601	1144D/RL	136	1169BM/D3	140
192/S2	27	1052BA	303	1100BA	303	1144G	137	1169G/D3	140
194	27	1052HS	288	1101	132	1144G/RL	137	1169GBM/D3	140
195	28	1052K	601	1101R	132	1144L	137	1169MQ/D2	283
195/B5	28	1053	129	1102	133	1144T	137	1169N/D4	140
195AS	28	1054	129	1103	133	1148A	137	1171BM	140
195AS/B	28	1055	129	1103R	133	1148A/R	137	1172BM	140
195FTX/B4	28	1055D	129	1104	133	1148B	137	1172BM/P	141
195K	597	1056	129	1104R	133	1148B/R	137	1173BM	141
195P	28	1057A	129	1105	133	1148P	137	1175BM	141
195P/B5	28	1058	130	1105/C10T	133	1149F	137	1177BM	141
1002	125	1059	130	1105/C16T	133	1150	137	1177BM/Z	141
1008	126	1060	130	1105/C32T	134	1150BA	303	1178BM	141
1008BM	126	1061	130	1105AD-50	133	1150BM	138	1178BM/P	141
1009	126	1062	130	1105T20	133	1150BM-HS	289	1182BM	141
1009L/A	126	1062AL	130	1105T30	133	1150BMK	602	1183BM	142
1009L/B	126	1062GM	130	1105T50	133	1150G	137	1184BM	142
1009L/C	126	1063	130	1112	134	1150GBM	138	1185BM	142
1009L/D	126	1064	130	1112K	601	1150GBMK	602	1186BM	142
1009L/DP	126	1065F	130	1114	134	1150GK	602	1188BM	142
1009L/DP-S2	126	1065P	130	1118	134	1150HPC	138	1190BM	142
1010	126	1066	131	1120A	134	1150INOX	295	1191BM	142



# ÍNDICE ALFANUMÉRICO

1191BM/L	142	1256PZ	148	1272BA	303	1294K	605	1366B	161
1191R/5-M	142	1256RTX	148	1272MQ	283	1294L	156	1366KF	161
1200MS	142	1256TX	148	1272MQ/S	283	1295	156	1366S/R1	162
1201E	143	1257BE	149	1272MQF	283	1295/C14	157	1366S/R10	162
1201E/DZ	143	1257ES	149	1273BG-MQ/DV4	614	1297TX	157	1366S/R11	162
1201E/K	603	1257ESB/S8	149	1273MQ/D6	283	1297TX/D6	157	1366S/R12	162
1201E/S6	143	1257LP	149	1273MQ/E1	614	1297TX/L	157	1366S/R13	163
1201EN	143	1257LP/S	149	1273MQ/E4	614	1297TX/L-S5	157	1366S/R14	163
1201EN/K	603	1257LPH/S8	149	1273MQF/D...	283	1297TX/S12	157	1366S/R2	162
1202E	144	1257PH	149	1273MQF/D4	283	1298RTX	157	1366S/R21	163
1202E/K	603	1257TX	149	1274MQ	283	1298RTX/S8	157	1366S/R22	163
1202E/S4	144	1257TX/S	149	1274MQ/S	283	1298RTXK	605	1366S/R24	163
1202EL	144	1260	150	1274MQF	283	1299HS	289	1366S/R25	163
1202EN	144	1260/S6	150	1275MQ/C	283	1299N/PZ	157	1366S/R26	163
1202EN/K	603	1260E	151	1276MQ/C	284	1299N/PZK	605	1366S/R3	162
1203/E4P	612	1260EK	604	1277BA	303	1299PZ	157	1366S/R4	162
1203E/D	144	1260K	604	1279MQ	284	1299PZ/S6	157	1366S/R5	162
1203E/E10P	612	1260MC	151	1279MQ/F	284	1299PZK	605	1366S/R6	162
1203E/E1P	612	1260N	150	1279MQ/S	284	1302	158	1366S/R7	162
1203E/E5P	612	1260NK	604	1281BG	153	1303	158	1366S/R8	162
1203E/S	144	1262	151	1281BG/A9	154	1304	158	1366S/R9	162
1204E	144	1262/S4	151	1281BG/B28NA	154	1305	158	1366SH	162
1204E/K	603	1262E	151	1281BG-TX/A8	154	1305Z	158	1366SH/C	162
1204E/S5	144	1262EK	604	1281LP	153	1306	158	1366SL	162
1204EL	145	1262K	604	1281LPH	154	1307	158	1367/K10	163
1205E/ES	145	1262L	151	1281PB	153	1308	158	1367/K4	163
1205E/ES-S8	145	1262MC	151	1281PE	154	1310	158	1368	163
1206E/BP	145	1262N	151	1281PH	154	1312	158	1368G/C2U	163
1206E/BP-S7	145	1262NK	604	1281PM	153	1314	159	1368G/CV	163
1207E TX/K	604	1263/D...	151	1281PZ	154	1326	159	1368G/K400	163
1207E/TX	145	1263/E39	613	1281RTX	154	1327	159	1368G/OD	163
1207E/TX-D	145	1263/E40	613	1281TX	154	1328	159	1368G/SD	163
1208E RTX/K	604	1263/E50	613	1290	155	1329	159	1369/C11	164
1208E/RTX	145	1263/E62	613	1290/S	155	1330	159	1370	164
1208E/RTX-D	145	1263/E70	613	1290HS	289	1331	159	1370/MR...	164
1209E PZ/K	604	1263/E74	612	1290INOX	295	1335BM	159	1370BA	303
1209E/PZ	145	1263/E78	612	1290K	605	1337/S5	159	1370BA/MR	304
1209E/PZ-S4	145	1263/E85	613	1290K/INOX	605	1338	159	1370BA/PL	304
1209EN/PZ	145	1263/S12	152	1290N	155	1338A - 1338B	159	1370F	164
1209EN-PZ/K	604	1263MC/D8	152	1290NK	605	1338R9 - 1338R12	159	1370F/MR...	165
1210E/GE	146	1264	152	1292	155	1342	159	1370FT	165
1211E/GE	146	1264/S5	152	1292/S4	155	1342PM	159	1370FT-HS	289
1229LP/A6	146	1264K	604	1292HS	289	1342PMR	159	1370INOX	295
1229LPH/A6	146	1264L	152	1292INOX	295	1343	159	1370T	164
1236B	147	1265ES	152	1292K	605	1344A/VW	160	1370T-HS	289
1238B	147	1265ES/S8	152	1292K/INOX	605	1345	160	1374F	165
1241	147	1266BP	152	1292L	155	1351	160	1374F/MR...	165
1242	147	1266BP/S8	152	1292N	155	1353	160	1375	165
1243/D7	147	1267MC/TX	153	1292NK	605	1357Z/45	160	1375/MR	165
1243/S11	147	1267MC/TX-D7	153	1293/D...	156	1359T	160	1375A	165
1243LP/D6	147	1267TX	152	1293/S...	156	1360/K6	160	1375B	165
1250	147	1267TX/D7	153	1293BP	156	1360/KP3	160	1375BA/PL	304
1251	147	1267TX/S13	153	1293BP/S7	156	1361/C12	160	1376X	165
1252/S5	147	1267TXK	604	1293BX/DA	614	1361/K9	160	1376X/MR	165
1253	148	1268RTX	153	1293BX/DD	614	1364SCP	161	1376XT	165
1253A	148	1268RTX/S8	153	1293BX/DE	614	1364SE	160	1376XT/MR	165
1254	148	1268RTXK	605	1293BX/DF	614	1364SP	161	1377	165
1256/20	148	1269N/PZ	153	1293ES	156	1364SR	161	1377/MR...	165
1256/30	148	1269N/PZK	605	1293ES/S7	156	1364SV	160	1377BA	304
1256/C36-2	148	1269PZ	153	1293INOX/D8	295	1365/K13	161	1377BA/PL	304
1256LP	148	1269PZ/S4	153	1294	156	1365P10	161	1377INOX	295
1256PE	148	1269PZK	605	1294/S7	156	1366/K5	161	1377T	166
1256PH	148	1270BA	303	1294HS	289	1366A	161	1378	166



# ÍNDICE ALFANUMÉRICO

1378/MR...	166	1457/B4	170	1476A/RC	176	1493/C7	182	1498/SC441	191
1379BA	304	1458	170	1476C/1	176	1493/PF	182	1498/SC540	191
1379F	166	1460F	170	1476GT	176	1493/S-U	183	1498/SC640	192
1379F/MR...	166	1462/EI	171	1476PSA	176	1493AL	182	1498/SP150	190
1380	166	1462/KEP	171	1477/C10	177	1493AL 4S	182	1498/SP250	191
1380/MR...	166	1462/KI	171	1477/C38	177	1493AL CF	182	1498BC/12	186
1380BA	304	1462/MB	171	1477D/S5	177	1493B	181	1498EL/12	187
1380BA/MR	304	1462CF	171	1478	177	1493DSG	182	1498EL/12-24	187
1380BA/PL	304	1462CF/C6	171	1478/K3	177	1493FF/2	182	1498EL/12-R01	188
1380S	166	1464APB	172	1478NSS	177	1493H	183	1498H/16A	189
1380S/MR...	166	1464APD	172	1478SP	177	1493J	182	1498H/25A	189
1380T	166	1464BP	172	1478T	177	1493X	183	1498H/4A	189
1381	166	1464CBD	171	1479	177	1493Y	183	1498H/8A	189
1381/MR...	166	1464FAP	172	1479/B27	177	1494	183	1498LT/12	187
1381BA	304	1464PO	172	1479L/K4	178	1494/C14A	184	1498LT/12-24	187
1381BA/MR	304	1464PT	172	1479L/S2	178	1494BMW	183	1498LT/12-R7	187
1381BA/PL	304	1464T/N	171	1479LB/C5	177	1494E	183	1498LT/12-SF	187
1381T	166	1464T/SP80	171	1479LV/S3	178	1494FPC	183	1498MN/12-C	186
1385	167	1464VD	172	1479N/S5	178	1494M	184	1498MN/12-P	187
1385/MR	167	1465	173	1479RB/1	178	1494MAN	183	1498MN/12-R	186
1390	167	1466/C5	173	1479RB/2	178	1494MRC	183	1498PC	194
1390/MR...	167	1467	173	1479RB/3	178	1494Q	184	1498PRO/12	188
1390BA	304	1467/RK1	173	1479U/13	178	1494T	184	1498PRO/12-24	188
1390BA/R	304	1467LF/2	173	1479U/32	178	1494T/C5	183	1498PRO/12-24 R01	188
1390HS	289	1467LF/RC	173	1480	178	1494VW	183	1498PRO/12-R01	188
1390N	167	1467T/C6	173	1481/C12	179	1494VW/K	184	1498SA/2A-4A	188
1390NR	167	1467TU	173	1481K/S4	179	1494VW/KT	184	1498SM	193
1390R	167	1470	173	1481PL/A	179	1494XZN	184	1498ST/TB ROT	193
1391	167	1470FT	174	1481PL/S3	179	1495/C6	184	1498TB/12-24N	193
1391A	167	1471	174	1481T/C12	179	1495M	184	1498TB/6-12	193
1392	167	1471C	174	1482	179	1495T	184	1499	194
1392HS	290	1471CF	174	1482/8 - 1482/10	179	1496/C	184	1500/...	194
1392R	167	1471CM	174	1482A/1B	179	1497/C23	185	1500/SP	194
1393	167	1471CM/E11	174	1482A/3	179	1497/C94	185	1500G/...	194
1410/M	168	1471D2	174	1482B	179	1497BS	185	1500N/...	194
1428	168	1471GF	174	1482C	180	1497D	184	1500N/G...	194
1428/SB11	168	1471M/50	174	1482SN	179	1497P	185	1500N/SP	194
1428/SB5	168	1471M/C22	174	1483KV-PT/S7	180	1497RC	185	1501/1 - 2 - 3	194
1428L/B3	168	1471PT/C5	174	1484	180	1497SS	185	1501G/1 - 2 - 3	195
1429	168	1471T/C5	174	1485/KIT	180	1497TE	185	1501Z/S - P - R	195
1429/SB7	168	1472	175	1485BP	180	1498	185	1502/...	195
1430/...	168	1472AU	175	1485FCA/K2	180	1498/12-24 R20	188	1505V	195
1430/S	168	1472AU/P	175	1485R	180	1498/2A	188	1506	195
1431/...	169	1472AU/RP	175	1485R/P10	180	1498/2A-8A-PR	188	1508/1 - 1508/2	195
1431/C5	169	1472B/RNLT	175	1485R/P17	180	1498/4A-8A CO	188	1511/1 - 2 - 3	195
1433	169	1472FC	175	1485TC	180	1498/4A-8A CP	188	1515/1 - 2 - 3	195
1433/C11	169	1472FC/GE	175	1488 - 1488L	180	1498/AM30	190	1516/1 - 2 - 3	196
1435	169	1472FC/L	175	1488/1	180	1498/AT1001	192	1517	196
1435/1	169	1472FCL/RP	175	1488R...	180	1498/AT1300	192	1517C/...	196
1435/1R	169	1472PU	175	1489/33	181	1498/AT2000	193	1518/...	196
1435R	169	1472PU/P	175	1489/Y	181	1498/AT300	192	1518U/...	197
1438	169	1472R/AU	175	1490	181	1498/AT500	192	1519/...	197
1438DSG	169	1472VW	175	1490/R1 - 1490/R2	181	1498/AT701	192	1520/1 - 1520/2	197
1438EVO	169	1473	176	1490F	181	1498/DG1100E	193	1521/1 - 1521/2	197
1438R	169	1473A	176	1491	181	1498/DG540E	193	1528	197
1439/K7	170	1473FN	176	1491A	181	1498/PR14	189	1529	197
1440/...	170	1473P	176	1491R	181	1498/PR17	190	1529PI	197
1445/1 - 1445/2	170	1474DL	176	1491T	181	1498/PR20	190	1530/C5	197
1452K	170	1474G	176	1492/1 - 1492/2	181	1498/PR25	190	1531/C7	198
1452PN/K	170	1474L	176	1492T	181	1498/PR35B	190	1532	198
1454P	170	1476	176	1493	181	1498/RP380	191	1533/...	198
1455SVP	170	1476/RC	176	1493/C19	182	1498/RP480	191	1533PR/1 - 2 - 3	198
1455SVP/R...	170	1476A	176	1493/C30	182	1498/SC341	191	1534/...	198





# ÍNDICE ALFANUMÉRICO

1535/C...	198	1599T	204	1662SP0	207	1701PMR	212	1719BM/RP	218
1539	198	1600Q 10	204	1662SP2	207	1702N	212	1719BM/RR	218
1540	198	1600Q 8	204	1666	207	1702N/PM	212	1719BMA...B5	217
1542/1 - 1542/2	198	1601/PC	585	1666A	207	1702PMR	212	1719BMA...M	217
1544/...	199	1602	585	1668	207	1703BA/A	305	1719BMA...P	217
1545/C5M	199	1602/C9	585	1668A	207	1703BA/P	305	1719BMA...Q	216
1547/C6	199	1602A	586	1670	207	1703BA/PL	305	1719BMA...R	217
1547KP	199	1602A-HS	290	1670A	207	1704	213	1719BMA...S5	217
1547P	199	1602BA	305	1672	208	1704A	213	1719BMA...T	216
1547PC/2	199	1603	586	1672A	208	1704C	213	1719BMB/P	218
1547PL/2	199	1603A	586	1674A	208	1705	213	1719BMC	218
1550U	199	1603B	586	1674C	208	1705PT	213	1719BMD...B5	217
1550U/CGS-R	200	1603BK	606	1676	208	1706DGT	213	1719BMD...M	217
1550U/M	200	1603K	606	1678/C3	208	1707	213	1719BMD...P	217
1550U/MRC-ABE	200	1606/2	586	1679	208	1707A/1 - 2 - 3	213	1719BMD...Q	216
1550U/MRC-C	200	1606A	586	1679/PR	208	1708/8 - 13 - 20	213	1719BMD...R	217
1550U/S...	200	1606A/C9	586	1680	208	1708HS/20	290	1719BMD...S5	217
1550U/SS187	200	1606T	586	1680A	208	1709/10 - 1709/18	213	1719BMD...T	216
1551/C20	200	1607	586	1680B	208	1710	213	1719BMR	218
1552/C9	200	1608	586	1680C	208	1712E/1 - 2 - 3	213	1719BMR/B3	218
1555/Q	200	1608/C9	587	1682	209	1712TF	213	1719BMX...M	217
1555/QS	200	1608A	587	1682HS	290	1712TFS	214	1719BMX...P	217
1555S/BMW-RNT	200	1609	587	1683	209	1713M	214	1719BMX...Q	216
1556/1A	201	1609A	587	1685/C7	209	1713M/K7	214	1719BMX...R	217
1556/2A	201	1609B	587	1687/S4	209	1714	214	1719BMX...S5	217
1557/S3	201	1609C/C5	587	1687A	209	1715	214	1719BMX...T	216
1558/C13	201	1609M	587	1687AC	209	1715B/R5L	214	1720/...	218
1558/C4	128	1610-B	589	1687D	209	1715FL/A	214	1720/B	218
1558P	201	1614-P	589	1687U	209	1715FL/B	214	1720/S	218
1559	201	1616-SM	589	1688	209	1715I	214	1720D/...	218
1559V/8T	201	1618-SF	589	1688A	209	1715L	214	1720D/B	219
1560/2	201	1620-M	589	1688M	209	1715R/FL	214	1721/B6	219
1560A	201	1622-F	589	1688PC	209	1716A	214	1723	219
1561/...	201	1624-FI	589	1688PC/R	209	1716P	214	1725	219
1562D	201	1628-C	589	1690F	209	1716R	214	1725CR	219
1565/1 - 2 - 3	202	1630-CR	589	1690L	209	1716U	214	1725MQ	284
1566/GO1	202	1632-TS	589	1691BM	210	1717A	215	1726	219
1566/VAG	202	1634-TD	589	1691MG	210	1717B	215	1726BM	219
1566N	202	1635-D	590	1692	210	1717BA	305	1727	219
1566R	202	1635-S	590	1692HS	290	1717BA/1	305	1727BA	305
1567	202	1638M	594	1693	210	1717C	215	1727BM	219
1568	202	1639EAB	594	1693L	210	1717D	215	1727HS	290
1569/F	202	1639ESB	594	1693M	210	1717T	215	1728...	219
1569/SB	202	1639ESC	594	1694/L	210	1717T RS	215	1728BA	305
1569CP	202	1639ETA	594	1694A/L	211	1717T RT	215	1729CG	219
1570/3	203	1639S	587	1694B/L	211	1717V	215	1729DM 450	219
1580/8I	203	1650	205	1695XS	211	1717V R	215	1729J	219
1580GL	203	1650FD	205	1696	211	1718A...M	216	1729MF	219
1585/5I - 6I - 7I	203	1651DGTB	205	1696A	211	1718A...P	216	1729MF/CG	219
1585GI/5 - 6 - 7	203	1651DGTB/IP	205	1696B	211	1718A...Q	215	1729MF/J	219
1589PI/50 - 100 - 150	203	1652	205	1696D	211	1718A...R	216	1729MF/M	220
1589VI	203	1654	205	1696S	211	1718A...S5	216	1730	220
1590	203	1654DGT	206	1696T	211	1718A...T	216	1730INOX	295
1591	203	1656	206	1697	212	1718D...M	216	1736A	220
1593	203	1657DGT/2	206	1699L	212	1718D...P	216	1737	220
1594	203	1658/...	206	1699L/1	212	1718D...Q	215	1737AC	220
1595	204	1658/C4	206	1699Q	212	1718D...R	216	1737B	220
1599B	204	1658DGTB	206	1700N	212	1718D...S5	216	1737BA	305
1599F	204	1658SP/1	206	1700N/PM	212	1718D...T	215	1737NX	220
1599G	204	1659	206	1701BA	305	1719BA12	305	1738	220
1599GI	204	1662/1 - 1662/2	206	1701N	212	1719BA8	305	1739C	220
1599GR	204	1662AN	207	1701N/PM	212	1719BM/RG	218	1740AN	220
1599P	204	1662DGT/A	206	1701NE/...	212	1719BM/RL	218	1740B	220



# ÍNDICE ALFANUMÉRICO

1741	221	1755C	224	1763G/S500	232	1812 150	245	1851VK	318
1741/C5	221	1755P	224	1764/K5	232	1814M	245	1851VK-12C	318
1741P	221	1756	224	1764/K5-R	232	1820	245	1851VK-12V	318
1741RV...K	221	1756B	224	1766	232	1822	245	1852 S-PATTE	244
1741TR	221	1756D	224	1766/8	232	1823 60	245	1852R1750	244
1741U	221	1756D-2OR	225	1766A	232	1823R/60	245	1852S-CC	244
1742AN	222	1756E	224	1766ER	232	1824R	245	1852S-CNT	244
1742AN/C	222	1756G	224	1766ER/VW	232	1825B	245	1852S-F	244
1742AN/KR	222	1756V	224	1766G	233	1827	245	1852S-FLESS	244
1742N	221	1756V-2OR	225	1766I	233	1827/K	246	1852S-KR/CNT	244
1742N/C4	222	1757	225	1766T	233	1827F	246	1852S-L	244
1742N/KR	221	1757A	225	1767A	233	1827PC	245	1870	318
1742R-A/M...	222	1758	225	1767B	233	1827PCL	245	1870-20/5S	319
1742R-AL/M...	221	1758ADB-45°	225	1767PMC	233	1827PFL	246	1870-72 /FC	319
1743	593	1758ADB-D	225	1767PMR	233	1830T	246	1870-72/FL	319
1743HS	290	1758B	225	1768	233	1833L	238	1870I	318
1743T	593	1758B/K5	225	1770	233	1833M	238	1872L	319
1748-BA1	592	1758B-1,6	225	1770A	233	1833MW	238	1872L 35/5S	319
1748-BA2	593	1758BA	305	1770RL	233	1833S	238	1872L 35/FC	319
1748-BH	592	1758B-RNT	225	1771	233	1833XL	238	1873	319
1748-BL	591	1758LG	226	1771BM	234	1833XS/1	238	1873-30/5S	319
1748-BP	592	1758M	226	1771HD	234	1833XS/2	238	1874	319
1748-BR	592	1758R	226	1771RL	234	1833XSW	238	1874-50/5S	319
1748-BT	592	1758RD	226	1772H	234	1836AW	238	1874-50/FC	319
1748-BT2	592	1758S	226	1772H-HS	290	1836B	239	1875LT	247
1748-BT3	592	1758VT	226	1772M	234	1837C	241	1875SP/K3	247
1748-BV	593	1758VT/L	226	1772R	234	1837F/USB	239	1877	247
1748-BV0	591	1759	226	1772RL/2	234	1837RB-F/USB	239	1877A	247
1748-BV2	590	1759A	226	1773A	234	1837S	241	1877F	247
1748-BX	591	1759B	226	1773RL	234	1838/11LED	239	1877P	248
1748N	590	1759HD/3	227	1773S	234	1838AM	240	1878 11	248
1748-N	594	1759HD/RR	227	1773S/RL	234	1838COMPACT	240	1878 2	248
1748-N2D	591	1759HD/TRUCK	227	1773U	234	1838E	241	1878 30	248
1748-NA1	592	1759LR	227	1773U/R	234	1838E-BT	241	1878 4	248
1748-NA2	593	1759TT	227	1774	234	1838FLASH	240	1878 8	248
1748-NL	591	1760/IR1000	231	1774A	234	1838PN	240	1879	248
1748-NV	593	1760/IR1600	231	1774A/RL	235	1838POCKET	240	1879 6	248
1748-S	593	1760/IR500	230	1774S	235	1838RA/10-11LED	239	1879/FUEL	248
1748-SC	593	1760/RMS	229	1776BA	305	1838RB/10LED	239	1879R/K4	248
1748-ST	594	1760/RSE	230	1777BM	235	1838RB/FLASH	240	1880	248
1748-UL	591	1760/TC2	230	1777BMT	235	1838RR/11LED	239	1880ADB	249
1748V	590	1760B	228	1777MQ/C	284	1838RV/11LED	239	1881	249
1749	222	1760BHS	290	1777MQ/U	284	1838SLIM	240	1882N	249
1749A	222	1760DGT	228	1777RL/U	284	1838SW	239	1883N	249
1749A/RB	222	1760DGT/2	228	1777T	235	1839/R1	241	1883NC	249
1749A/RT	222	1760DGT-R3	230	1778AN	235	1839/R2	241	1884	249
1749AC	222	1760K	230	1778AX	235	1839/R4	241	1884N/C8	249
1750	222	1760LX	231	1778BS	235	1839/R5	241	1885	250
1750HS	290	1760OHM/2	228	1778CM	235	1839/R6	241	1885/C1-R1	250
1750KG10	223	1760PA/80	229	1778M7	235	1839BRW	241	1885/C1-R2	250
1750M	223	1760PA/AC	229	1778MT	236	1842	243	1885/C1-R6	250
1750M3	223	1760PA/AC-DC	229	1778P	235	1842LED/ABM	242	1885/C1-R8	250
1750PF	223	1760PA/AC-DC2000	229	1778SCL	235	1842LED/BM	242	1885/C2-R1	250
1750R/1 - 1750R/2	223	1760PT/N	230	1778SOS	235	1843	243	1885/C2-R6	250
1750RC	223	1760R/TC2	230	1778SOS-HS	291	1844	243	1885/C2-R7	250
1750RP/1 - 1750RP/2	223	1760S	229	1778V18	236	1844SCK	243	1885/C3-R10	251
1750RT	223	1760TMC	231	1778X	236	1845	243	1885/C3-R3	250
1750TA	223	1760WM	231	1781	236	1846	243	1885/C3-R4	250
1750TLA	223	1761	231	1783	236	1846R-LED/BM	243	1885/C3-R5	250
1751CR	223	1761RS/1	231	1784	237	1847	244	1885/C3-R6	250
1751N	224	1762	232	1784BA	305	1848	244	1885/C3-R7	251
1752	224	1762K	607	1800/100	237	1850D	318	1885/C3-R8	251
1754	224	1763	232	1808	245	1850E	318	1885/C3-R9	251



# ÍNDICE ALFANUMÉRICO

1885/XC60	251	1921N3	323	1938R/L	333	1972/20V-13BMC	309	2001/BZV	344
1889CF	249	1922P1	323	1938R/S5	333	1972/K12V-10	307	2002/BV42	346
1889N	249	1922P2	323	1940	333	1972/K12V-COMBO	307	2002/BV6	9
1893/1234YF	251	1922P3	323	1940/C6	333	1972/K20V-13BMC	309	2002/BV7-ZIP	154
1893/134A	251	1924F	323	1940/S5	333	1982/12V	308	2002/BVL6	25
1893TR/1234YF	251	1924XM	324	1,94E+13	333	1982/K12V	307	2005MPU	346
1893TR/134A	251	1927AN	326	1940E10/MT	334	1984 20V/1200BMC	311	2005MPU/E	346
1893TR/CI	252	1927C	325	1940E10/S...	334	1984 20V/600BMC	310	2005PA/D	346
1895 13	252	1927E	325	1940E10/S5	334	1984/K1200	311	2005PA/E	346
1895 157	253	1927G	326	1940MT	333	1984/K600	310	2005PA/ET	346
1895 27	252	1927OLS	324	1940S...	333	1986/20V-125BMC	312	2005PA/S	346
1895 6	252	1927P	325	1942A	334	1986/K20V-125	312	2005PA/U	347
1895/RC	253	1927P/K3	325	1942LR	334	1989RCB	314	2009N/BV	346
1895/S	252	1927SP-AM	326	1944A	334	1994B 20V-2AH	313	2028/VV	347
1895GSI	252	1927XM	325	1944AR	334	1994B 20V-4AH	313	2028E	347
1898/B	253	1927XM/K5	325	1944N	334	1994B 20V-6AH	313	2029/VV	347
1898/C	253	1928DA	326	1944PA	334	1994BL 12V-2AH	308	2029E	347
1898/D	253	1928DAL	326	1945P	335	1994C 20V	313	2029EM	347
1898/K40	253	1928K4	326	1945P/S...	335	1994CB 12V	308	2032/TE	348
1898/M	254	1928P	327	1945S	334	1995MQ/T	284	2032/TV	347
1898/S	254	1928XM	326	1945S/G...	334	1996MQ/T	284	2033L	348
1899A	254	1930A	327	1946	335	1996VPG	284	2033L/VV	348
1899SI	254	1930HLA	328	1946C/T...	335	1997MQ/GM	284	2036/TV	348
1900M	339	1930LA	327	1946C4,8	335	11001	580	2036E	348
1900S	339	1930LH	327	1946C7,8	335	11011	580	2037/TV	348
1914	340	1930PA	327	1946KF	335	11021	580	2038/TV	348
1915B	340	1930ZL	328	1946KF/M...	336	11023	580	2041UC	349
1915C	340	1931AN10	328	1947	336	11034	580	2051N	349
1915C/L	340	1931CD10	328	1947G	336	11035	580	2055HB	349
1915D	340	1931CD13	328	1947G2	336	11038	580	2080/DL	349
1915E	340	1931CD6	328	1947H	336	11045	581	2080/DS	349
1915E/XL	340	1932B10	329	1948	336	11046	581	2080/V12	350
1916G	340	1932B13	329	1948PR	336	11049	581	2080/V12-...	350
1916GF	340	1932RS13	329	1949BC	337	11101	581	2080/V17	349
1916GFE	340	1933	329	1949BC/RUL	337	11107	581	2080/V6	350
1916I	340	1933AN90	330	1949DGT/2	338	11111	582	2080/V6-U	350
1916JF	340	1933AN90-H	329	1949F2	338	11116	582	2080/VG	254
1916JM	340	1933I	330	1949GPA	338	11131	582	2109MT ID/1	352
1917F	341	1933IH	329	1949M	338	11202A	582	2115P L-MQ32	354
1917JF	341	1933IL	330	1949P	337	11202B	582	2115PI/BIKE-HOME	354
1917JM	341	1933ILH	329	1949R	338	11204A	582	2250-O	254
1917M	341	1933L	330	1949T	337	11204B	582	2251N	254
1917RG	341	1934BV	330	1949U5	337	11210A	583	2252	255
1917SP	341	1934MAV	330	1949U5/A	337	11210B	583	2252KR4	255
1918	341	1934MAV70	330	1949U5/B	337	11214A	583	2254A	255
1918N	341	1935F	331	1949U5/C	337	11216A	583	2254C	255
1918R	341	1936/4A	331	1949U5/D	337	11216B	583	2254F	255
1919F1/2	342	1936/5A	331	1949U5/E	337	11234A	583	2254K	255
1919F1/4	342	1936/7A	331	1949U5/F	337	11246A	584	2254SM	255
1919F3/8	342	1937	331	1949U5/G	337	11248A	584	2254T	256
1919FE1/4	341	1937C...	332	1949XS	336	11259	584	2258N-O	255
1919L	342	1937K...	332	1950BZK	338	11260	584	2258RR	255
1919ML	342	1937KC	331	1950BZK/T	338	11263	584	2300ST/KIT	361
1919RB-F	342	1937KL	332	1950GPP	339	11264	584	2400 RSC24/MP	370
1919RB-FE1/4	341	1937KL-D	332	1951	339	11265	584	2400 RSC24/PC	369
1919RF-F	342	1937M	332	1951A	339	11266	584	2400 RSC24/PD	369
1919RF-FE1/4	341	1937M-01+11	332	1952	339	11268	584	2400 RSC24/PF	369
1919RM-F	342	1937N10	332	1956 115-750W	315			2400 RSC24/PF-	369
1919RM-FE1/4	342	1937N10-GR	332	1956 125-1400W	316			2400 RSC24/PL	369
1919SC	342	1937N20	332	1956 230-2400W	316	2001/B26	344	2400 RSC24/SPC	370
1921B1	323	1937N20-GR	333	1966/910W	317	2001/BV	344	2400 RSC24AXLP/CPR	368
1921M1	323	1937R/P	331	1967/800W	317	2001/BZ24 MQ	345	2400 RSC24AXLP/PF	367
1921M2	323	1938	333	1972/12V-10	308	2001/BZ27 VU	345	2400 RSC24AXLP/VL	369
								2400 RSC24AXXL/PF	368





# ÍNDICE ALFANUMÉRICO

2400-COVER RSC24	383	340RL	30	386A/RC	35	3026/S	261	3065/40-20T	265
2400-COVER RSC24AXL	383	341	30	386BA	300	3026/SA	261	3067/60-15T	266
2499PC	370	341B	30	387	35	3026/SAM	261	3067/70-13T	266
2499PF	370	341B/RL	31	387R	35	3026/SP	261	3068	266
2499PF/M	370	341B/RM	30	388	35	3027N 10	261	3069	266
<b>3</b>		341RL	30	388A	35	3027N 100	262	3070B	270
		342	31	388C/C8	35	3027N 20	261	3070B/...	270
30	9	342A	31	389/K4	35	3027N 30	261	3071A	270
30BA	297	342A/MOL	31	392C	35	3027N 50	261	3071B	270
31	9	342A/RL	31	392RG/C	35	3027N/KP	262	3071RS	270
31/B6N	9	342MOL	31	393	35	3027N/KPP	262	3072N	270
31/B6N-LSE	9	342P	31	395	35	3027PR/N	262	3073	270
31/SP6	9	342P/RL	31	395T	35	3028 15	262	3074O	271
31BA	297	342RL	31	398	35	3028 20	262	3074O/2	271
31BA/C	297	345	31	399	35	3028 30	262	3074O/M	271
31BM	9	345C	31	399R/...	35	3028 50	263	3074O/S	271
31BM/D6	9	345SB	31	3000L	256	3028/KP	263	3075/CM	271
31L	9	345SB/R	31	3000L/RLS	256	3028SP/15	262	3075/K10	271
31SE	9	345SB2	31	3000M/PLM	375	3028SP/20	262	3075B	271
32	9	345SC	32	3002	256	3028SP/30	263	3075MV	271
32AU	9	345SI	32	3002/RLS	256	3028SP/50	263	3080/C15	271
32AUR	10	345SI/R	32	3003	256	3029/2T	263	3080R/CS3	271
32BA	297	345U	31	3003/RLS	256	3029/2T-L/R5	263	3081	271
33LT	10	345U/A	31	3003C	256	3029/2T-L/R6	263	3085	271
33NR	10	349	32	3003C/RLS	256	3029/2T-L/RP	263	3091	272
34	10	349/SMAS	32	3003PRO	256	3029AL/1,5T-R1	263	3092	272
34BA	297	349/SMM	32	3003PRO/PM	256	3029AL/1,5T-R2	264	3093/E	272
34INOX	293	350	32	3003PRO/RCR	256	3029AL/1,5T-RP	264	3093/U	272
35	10	351C	32	3003PRO/RRG	257	3029AL/1.5T	263	3095	272
35HS	285	351P	32	3003PRO/RT	257	3029L/2T	263	3099E	272
35PM	10	352C/U	32	3003PRO/SP	256	3030/2T	264	3099T	272
35PMR	10	352U	32	3004	257	3030/2T-R5	264	3500/P-M	377
36	10	355	32	3006	257	3030/2T-R6	264	3700/PC	380
37	10	357F3	32	3006 R/RG	257	3030/2TRP	264	3700/PF	380
37PM	10	357R/F3	33	3006 R/RGF	257	3030H/2T	264	3700/PFL	380
37PMR	10	358	33	3007	257	3033/3T	264	3700/PLA	380
38/B6N	10	358RL	33	3007 R/RG	258	3033E/3T	264	3700/PLL	380
38/DS1	611	359	33	3007 R/RGF	258	3033S 3T/R2	264	3910	274
38/DS2	611	359CH	33	3008M	258	3035	265	3912PP	274
38/S	10	360	33	3008N	258	3036	265	3912TP	274
39BA	298	360HS	287	3009	258	3040C	268	3912TP/A	274
39INOX	293	360R/...	33	3009R/GR4	258	3040C/S1	268	3912TP/C	274
310	28	361N	33	3010/T...	258	3040C/S2	268	3912TP/FOX	274
310/C8	28	362	33	3010H	259	3041C	268	3912TP/QRE	274
310B	28	362INOX	294	3010V	259	3041C/12	268	3912TP/ROAD	274
311	28	362R/...	33	3011/T	258	3041C/16	268	3912TP/RS	274
330	29	363	33	3012	259	3042C	268	3912TP/ST	274
330BA	300	363BA	300	3012C	259	3043C	268	3916MMP	275
330BA/2R	300	363R/...	33	3012I	259	3043C/ 41÷47	268	3918MML	275
330R/A	29	365	34	3014	259	3047C	268	3921	275
330R/I	29	365R/...	34	3014 SAR	259	3048C	268	3923	275
331C	29	366	34	3014R/GR5	259	3050/600	269	3927	275
332	29	374	34	3014SAR/1	259	3050/CC	268	3932U	275
334	29	374K	597	3014SAR/RR	259	3050/KA	269	3935	275
334R	29	374R/...	34	3023	259	3050/LA	269	3937	275
334R/I	29	375	34	3024 0,6	260	3050/MS	269	3948	275
336	30	376	34	3025N	260	3050/MV	269	3952	275
338	30	378	34	3025N/PF	260	3054	269	3952/S7	275
338R	30	378BA	300	3026 0,3	260	3055M	269	3953	275
338R/I	30	383	34	3026 0,5	260	3057	269	3955	275
338RP	30	383R	34	3026 1,0	260	3061/2T	265	3961 3,2	276
340	30	384	34	3026/R 1,0	260	3061/2T-P100	265	3961 3,3	276
340C	30	384RC	34	3026/R0,3	260	3061/2T-P50	265	3961 3,5	276
340C/KRL	30	386A	34	3026/R0,5	260	3065/20-10T	265	3961U	276



# ÍNDICE ALFANUMÉRICO

3962MV	276	412/SP91	37	430	44	451PA	53	5902MT/AS	530
3962SH	276	412A	37	430/SP	44	451PR	53	5902VI	494
3963P	276	412K	598	430ASC	45	452	53	5904VG/2M	531
3964	276	412L	38	430ASW	45	452GA	53	5904VG/2T	532
3965	276	412XL	38	431	45	460	53	5904VG/3	533
3965C	276	414	38	431/SP	45	460G	53	5904VG/5T	535
3967	276	414/C116	38	433	45	460PP	53	5904VI/1T	494
3969	276	414/SP	38	433ASF	45	4900-COVER C49	387	5904VI/2T	497
3969K3	276	415	38	433ASG	45	<b>5</b>		5904VI/3T	495
3971	276	415/C116	39	434	45			5904VU/1M	503
3972	276	415/SP	39	435	46	52	13	5904VU/2M	504
3973/1	276	415/SP91	39	435G	46	52MQ	279	5904VU/2T	505
3973/2	277	415CO	39	436	46	53	14	5904VU/3T	506
3973/3	277	415CO/SP	39	436L	46	55	14	5904VU/4T	507
3973/4	277	415CO-A	39	436R	46	55/B12N	14	5905VG/1	536
3973PF	276	415K	598	437C	46	55/B8N	14	5905VG/2	537
3975	277	415L	39	437C/...	46	55/S	14	5908VG/2T	538
3984/1	277	416	39	437C/RM14	46	55/SP	14	5908VI/2T	496
3984/2	277	416/SP19	39	437K/12	46	55/SP7	14	5908VU/2T	508
3984/3	277	416P/SP19	40	437K/33	47	55AS	14	5910VI/3	498
3984/4	277	417	40	437K/9	46	55AS/S	14	5910VI/3T	499
3984/5	277	417/SP	40	437P	46	55BA	298	5914VU/M	509
3984/6	277	418/K3	40	437U/09	47	55BA-AS	298	5915VU/0	511
3991	277	419	40	437U/E-M...	47	55HS	286	5915VU/1	511
3992	277	419/SP	40	437U/PM	47	55K	596	5915VU/2	512
<b>4</b>		419T	40	438...	47	58	14	5915VU/3	512
		420D/SP8	40	438A	47	58BA	298	5915VU/4	513
		421	41	440	47	58BA-AS	298	5915VU/5	513
42	11	421	41	440A	47	560/C12	55	5915VU/AS	514
42/B9N	11	421/SP6	41	440ASC	48	560/C2	55	5927VU/M	514
42/S	12	422	41	440ASF	48	560/C3	55	5935ET/1MB	522
42/SC9I-E	12	423A-CO	41	440ASG	48	560/C3PLUS	55	5935VG/1MB	539
42/SP	12	423CO	41	440ASW	48	560/C4+	55	5935VI/2MB	500
42/SP15	12	424	41	440B	47	560/C6	55	5940SBK	539
42/SP25	12	424/SP	41	441	48	561/1	55	5941VU/M	540
42AS	12	425	41	441A	48	562-1/VA - 562-2/VA	56	5945VUM	541
42AS/B9N	11	425/SP	41	441B	48	562VV-A	56	5954VG	542
42AS/S	12	426	41	442	49	564-3R/V - 564-4R/V	56	5954VI	502
42BA	298	426/SP	41	443	49	565-1R/VA - 565-2R/VA - 565-3R/VA	56	5957U-P	515
42BA-AS	298	426A/SP6	42	444	49	565-4R/VB	56	5957VG	543
42HS	285	426MD/CP	43	444G	49	565-5R/VB	56	5957VI	501
42INOX	293	426MD/CT	43	446/C110	50	565VV-B	56	5958U	516
42INOX/S	293	426MD/F	43	446/C30	49	567-4R/VB	56	5980EL/A	525
42INOX/SC9	293	426MD/FA	43	446/C48	49	567-5R/VB	56	5980EL/B	526
42INOX-AS	293	426MD/OG	43	446ASC/C37	50	581	60	5980ET/A	523
42INOX-AS/S9	293	426MD/OV	43	446ASF/C29	50	583	60	5980ET/B	524
42K	596	426MD/S	43	446ASG/C23	50	583/C31	60	5980ID/1	527
42LMP	13	426MD/SP10	43	446ASW/C36	50	590 - 592	60	5980MQ	524
42LMP/S	13	426MD/T	43	447/C37	51	594	60	5980U/BIKE	517
42MP	13	426MD/TA	43	447/C53	51	596	60	5980U/BIKE-M	518
42MP/B	13	426MD-3	42	447/C70	51	599DGT	61	5988 VHB-MQ	525
42MP/S	13	426MD-3/A9	43	450	51	599DGT-AW	61	5988H/7M	519
42SLIM	13	426SB	42	450/C13	52	5000 RSC50 2.0/ASL	488	5988L/4M	520
42SLIM/B8NI-E	13	426SB/SP	42	450/C15	52	5000 RSC50 2.0/CAL	463	5988U/7M	510
42SLIM/S11	13	426T	42	450/C21	52	5000 RSC50 2.0/CLL	463	5988U6/M	521
45	13	426T/SP	42	450/C9	52	5000 RSC50 2.0/CTR	489	5989 VEM	528
410	36	427	43	450AD	51	5000 RSC50 2.0/KFC	463	<b>6</b>	
410/SEL	37	428FC	44	450AL	51	5000 RSC50 2.0/MP	463		600
410/SP	36	428FC/C7	44	450PA/1	52	5000 RSC50 2.0/MPA140	463	601C	61
410A	37	428FP	43	450PA/2	52	5000 RSC50 2.0/PLEDC	488	601CA	61
410K	598	428FP/C7	44	450PR	52	5000 RSC50 2.0/PLED-ST	488	603	62
410MIX/SEL19	37	429FC	44	451	52	5700LAMP	396	604B	62
412	37	429FC/C7	44	451/C	53	5902MT	529	605BC/15	62
412/C150	37	429FP	44	451GA	53				
412/SP	37	429FP/C7	44						



# ÍNDICE ALFANUMÉRICO

605DGT/2	62	6600 M/253	619	6800RP/100	616	727/C16	75	7109D	667
605E	62	6600 M/27	616	6800RS	669	727/ES16	74	7212B	634
606MQ/50	280	6600 M/29	616	6888	616	727/ES16TX	74	7212G	635
610/5	62	6600 M/315	619	6888GS	669	727/ES16XZN	74	7213G	635
610L/5	62	6600 M/320	619	6888GW	669	727/ES22	75	7214FN	635
610L/5L	62	6600 M/326	619	<b>7</b>		727/ES22TX	75	7214G	636
611	62	6600 M/327	619			727/ES32	75	7215FN	636
612 ÷ 614	63	6600 M/33	616	73	15	727PI/16	74	7218FN	636
614/50	63	6600 M/330	619	73/B13N	15	727PI/16 1/2	74	7218G	636
615	63	6600 M/371	619	73/S	15	727PI/22	75	7220PEK	633
616 - 617 - 619	63	6600 M/380	619	78	15	727PI/32	75	7221PEK	633
621	63	6600 M/40	617	78AS	15	728	75	7222PEK	633
622	63	6600 M/406	619	78BA	298	728/15	76	7223PEK	634
641	63	6600 M/40K	622	78BA-AS	299	728/16	76	7241EN	629
642	63	6600 M/417	619	710	70	728/21	76	7241NC	630
643	64	6600 M/42	617	710/16	70	728/22	76	7241NFT	630
644	64	6600 M/427	619	710/20	70	728/22L	76	7243EN	629
650A	64	6600 M/430	620	710/21	70	728/25	77	7243NC	630
650H	64	6600 M/44	617	710/22	70	728/C10	75	7243NFT	631
652	64	6600 M/440	620	710/25	70	728/OR - 728/SP	77	7245NB	631
653	64	6600 M/456	620	710/C10	70	728AS	76	7246E	629
654	65	6600 M/465	620	710/OR... - 710/SP...	70	728B	75	7246NB	631
659/15	65	6600 M/47	617	720	70	728B/C10	75	7247NB	631
659/16	65	6600 M/480	620	720/15	74	728FTX	76	7248NB	632
666	66	6600 M/485	620	720/16	74	728L	76	7270Y	643
666 LBF.FT	66	6600 M/51	617	720/20	74	728L/S	76	7271V	643
666HS-ZR	287	6600 M/510	620	720/21	74	728LQ	76	7272V	644
667	66	6600 M/52	617	720/22	74	728LS	76	7273G	644
668N	66	6600 M/532	620	720/25	74	728ME	76	7274G	644
668RG	67	6600 M/534	620	720/C12	70	728ME/C6	76	7275N	644
668RGC	67	6600 M/542	620	720/C24	71	729	77	7276N	645
669N	67	6600 M/548	620	720/C6	70	729/15	77	7293HM	647
671B/C10	67	6600 M/555	620	720/OR... - 720/SP...	74	729/16	77	7294HM	647
671B/C5	67	6600 M/561	621	720/SN	73	729/21	77	7294HMC	647
671N/C10	67	6600 M/565	621	720AS	71	729/21L	77	7316NB	637
671N/C20	68	6600 M/566	621	720B	71	729/22	77	7316NG	637
671N/C30	68	6600 M/567	621	720B/C12	71	729/25	77	7317NA	637
674/C	68	6600 M/58	617	720FRD	72	729/OR... - 729/SP...	77	7320NA	638
677	68	6600 M/589	621	720FTX	73	729L	77	7321NA	638
677/C	68	6600 M/59	617	720FTX/SB	73	729LS	77	7322SA	638
677/CP2000	68	6600 M/592	621	720IC	72	729T	77	7323SA	638
677/CV - 678/CV	69	6600 M/61	617	720L	71	730	78	7328A	632
678/C	69	6600 M/63	617	720L/S3	71	730/15	78	7328N	632
680	69	6600 M/643	621	720LC	72	730/21	78	7340G	645
682	69	6600 M/650	621	720LC/C3	72	730/25	78	7340VA	645
6200AP/S10	669	6600 M/657	621	720LC/PM5	72	730L	78	7341V	646
6600 M/112	617	6600 M/658	621	720LC/S3K	598	733/15	78	7341Y	646
6600 M/116	618	6600 M/716	621	720LC/S5	72	7041LCD/4S	246	7342N	646
6600 M/120	618	6600 M/73	617	720LCL	72	7041LCD/4S-VE	246	7343N	646
6600 M/125	618	6600 M/811	622	720LCL/C3	72	7041LCD/4S-VI	246	7352B	639
6600 M/126	618	6600 M/812	622	720LS	72	7042LCD	246	7352G	639
6600 M/131	618	6600 M/813	622	720MC	71	7042LCD/RV	246	7352LG	639
6600 M/14	616	6600 M/842	622	720MC/C13	71	7042LCD/RV-INT	246	7354N	640
6600 M/14K	622	6800 CB/100	616	720ME	73	7043	246	7356G	640
6600 M/174	618	6800 FB/100	616	720ME/C8	73	7061TC	668	7356LN	640
6600 M/217	618	6800 GR/37	616	720MRC	72	7076BC	668	7356V	640
6600 M/217K	622	6800 VE	616	720RNG	72	7076BD	668	7357G	641
6600 M/218	618	6800AD/P	616	720S	71	7076BP	668	7357V	641
6600 M/22	616	6800AE	616	720S/SB6	71	7076BU	668	7362B	641
6600 M/223	618	6800AI	616	720TC/S5	73	7093BC	668	7363N	641
6600 M/230	618	6800BA	669	720TX	73	7093BD	668	7371V	642
6600 M/236	618	6800FO/100	616	720TX/C6	73	7104 90	667	7372B	642
6600 M/241	618	6800PL	616	720XZN	73	7105 6	667	7376A	642
6600 M/242	619	6800PM	616	720XZN/C6	73	7109A	667	7381N	642





# ÍNDICE ALFANUMÉRICO

7382N	643	7669N	662	850MQ	280	867XZN/L	84	8031R	680
7397H	648	7670G	662	851	78	882	85	8031R-K	680
7397M	648	7679GG	662	851SR	78	882AN	85	8032	680
7397S	648	7750N	662	852	79	882M	85	8032-K	680
7398 0/G	648	7780QN	662	855P	79	882M1	85	8040EN	683
7398EF	649	7800G	667	860/55	79	882MSR	85	8040EN-K	683
7398ESD	648	7815CM	657	860/58	79	882P	85	8040EZ	683
7398GEL	648	7818BL	654	860/58K	598	892	85	8040EZ-K	683
7398U	648	7818CM	654	860/C27	79	895	85	8041	682
7398UP	648	7818G	654	860/C38P	80	897	85	8041-K	682
7399 A/N...	649	7818LN	654	860LP	79	897L	85	8042EN	684
7421	649	7819G	654	860PE	79	8001TZ	674	8042EN-K	684
7422P	649	7820SG	655	860PH	79	8001TZ-K	674	8042EZ	684
7425	649	7821SG	657	860PZ	79	8001Z	674	8042EZ-K	684
7426P	649	7830SN	655	860RTX	79	8001Z-K	674	8043	683
7427	649	7831SN	657	860TX	79	8002ZD	675	8043-K	683
7430T	649	7840BL	655	861/C61P	82	8003ZD	675	8044	684
7431P	649	7849BL	659	861LP	80	8004ND	675	8048	676
7527	652	7850G	655	861MIX/A10	81	8005TZ	672	8049	681
7528	652	7860B	655	861MIX/A31	81	8005TZ-K	672	8049A	682
7529	656	7860G	655	861PE	80	8005WZ	672	8049V	682
7530	652	7861B	658	861PE/A10	81	8005Z	672	8050 D1÷D45	696
7545F	664	7861G	657	861PH	80	8005Z-K	672	8050 D46÷D48	696
7548C	664	7863G	658	861PH/C	80	8006Z	672	8050 D49÷D53	696
7548M	664	7865B	658	861PHZ/A10	81	8006Z-K	672	8051S	691
7550G	664	7865G	659	861PZ	80	8007Z	673	8051S-K	691
7550N	664	7867B	660	861PZ/C	80	8007Z-K	673	8052 - 8055S	690
7552BL	665	7867G	661	861RTX	80	8008N	673	8057R	690
7552G	665	7869G	660	861SP	81	8008N-K	673	8058R	690
7552N	665	7900G	656	861QTS	81	8008TZN	673	8058R/PS	696
7553BL	665	7903G	658	861TRW	81	8009FD	676	8060R	690
7553G	665	7905G	659	861TX	80	8009TZ	673	8060R/PS	696
7553N	665	7907G	661	861TX/A10	81	8009TZ-K	673	8061R	690
7553V	665	7909G	660	861TX/C	80	8009Z	673	8062	691
7579QN	660	7930MG	656	862F	83	8009Z-K	673	8063	690
7600G	652	7931MG	658	862F/A7	83	8010TZ	674	8063SL	691
7600N	652	7935MG	659	862LP	82	8010Z	674	8064S	691
7610G	653	7937MG	661	862PE	82	8010Z-K	674	8065SC	691
7610N	653	7940	656	862PH	82	8011TZ	674	8068S	682
7611G	656	7949	660	862PH/L	82	8011Z	674	8074	695
7636N	662	7971B	665	862PH-XL	82	8015	677	8074A	696
7637B	663	7978B	666	862PZ	82	8016	677	8074G	696
7637G	663	7980L	667	862TX	82	8016FR	678	8080	696
7640GG	653	7980NC	667	862TX/L	82	8016-K	677	8085R	689
7642G	663	7980RN	667	862TX-XL	82	8016U2	678	8086	689
7643G	663	7981N	667	862XP/A16	83	8016UGK	678	8090F	709
7644GG	663	7982N	667	866LP	83	8016U-K	678	8090R	689
7647GG	660	7984G	667	866PE	83	8018E	678	8091	685
7648GG	661	7985N	667	866PH	83	8018T	678	8091SL	685
7650	653	7996N	666	866PZ	83	8020	679	8092	686
7650B	653	7997GN	666	866TX	83	8020A	679	8092SL	686
7653G	659	7998GN	666	867/...	84	8021	679	8094	686
7654B	663	<b>8</b>		867/C20	84	8021A	679	8094SL	687
7654N	663		867/C38	84	8025	680	8096	687	
7657B	663	80	15	867/C52	85	8025-K	680	8096SL	687
7657N	664	80/S	15	867PE	83	8026A	681	8097	688
7658CM	661	83	15	867PE/L	83	8026A-K	681	8097SL	688
7659N	661	83/S	15	867RIBE	84	8026R	679	8098	688
7660B	653	83AS	16	867RIBE/L	84	8026R-K	679	8098SL	689
7660G	654	83AS/S	16	867RTX	84	8028	681	8100	689
7661B	657	88	16	867RTX/L	84	8028-K	681	8105	671
7661G	657	88/S7	16	867TX	84	8029R	679	8105-K	671
7664N	664	89BA	299	867TX/L	84	8029R-K	680	8109	671
7665N	664	89MQ	279	867XZN	83	8029RS	680	8109-K	671



# ÍNDICE ALFANUMÉRICO

8110	671	8181S	710	8285	704	93K	596	96TBP/S	22
8120	695	8182	710	8286	704	94	17	96TBP-HS	286
8120B	695	8182 8,5/B2	711	8287	704	94/S	17	96THS	286
8120D	695	8182A	711	8290	705	94K	596	96THS-AS	286
8120DZC	695	8182E	710	8293	705	95	17	96TINOX	294
8121MZC	695	8182GD	711	8297C	705	95/S	17	96TINOX/S5	294
8129	695	8182H	711	8297F	705	95BA	299	96TINOX/S8	294
8130	695	8182H/2	711	8302Z	676	95FTX	17	96TINOX-AS	294
8134	691	8182S	711	8303Z	676	95FTX/S	17	96TINOX-AS/S7	294
8135	692	8182T	710	8381SX	705	96	18	96TK	597
8135/KLA1	697	8182TS	710	8600 R/11	623	96/B	18	97BRTXL/SC8	23
8135/KMO	697	8183	712	8600 R/113	623	96/BG7	18	97BTX	22
8135H	692	8184	711	8600 R/114	623	96/BGS7	18	97BTX/B	22
8143	692	8185	712	8600 R/12	623	96/SC12	18	97BTX/SC8	22
8143/RKCI	697	8186	712	8600 R/13	623	96/SC9	18	97BTX-C/SC8	22
8143/RKL	697	8187	712	8600 R/225	623	96/ST	18	97BTXL	22
8143/RPC	697	8188/K8	713	8600 R/412	623	96/ST6K	596	97BTXL/SC8	22
8143/RPF	697	8188C	712	8600 R/511	623	96AS	19	97RTX	23
8143SL	692	8188CG/25	713	8600 R/601	623	96AS/B	19	97RTX/B	23
8146	693	8188CU/25	713	8600 R/602	623	96AS/BG7	19	97RTX/SC8	23
8146/RK	697	8188F	713	8600 R/611	623	96AS/SC9	19	97TTX	23
8146/RKCI	697	8188F35	713	8702N - 8702Z - 8702ZC	676	96AS/T	19	97TTX/S	23
8146/RKFC	697	8188VFG2	713	8709N - 8709Z - 8709ZC	677	96BA	299	97TTX/SP	23
8146/RKL	697	8189	713	8871	291	96BA/BP	299	97TTXHHS	286
8146/RPC	697	8189A	713	8872A	291	96BAF-AS	300	97TX	22
8146C	693	8189PA	713	8872AS	291	96BP	20	97TX/B	22
8146SL	693	8190	712	8873	291	96BP/AS	21	97TX/BG8	22
8147C	694	8190B	712	8877	291	96BP/ASB	21	97TX/G	22
8147C/RKR	698	8201T	700	8877M	291	96BP/AS-SC9	21	97TX/SC8	22
8147P	694	8205	699	8879	291	96BP/SC9	20	97TX/ST	22
8147S	694	8206	699	8880	291	96BPA	21	98XZN	23
8147S/RKR	697	8207	699	8883	291	96BPA/SC9	21	98XZN/B	23
8148	694	8209	699	8889C1	569	96BPC	20	99	23
8148/RA	698	8210	699	8889C2	569	96BPC/SC9	20	99 VN/...	24
8148/RKCL	698	8210F	700	8889C3	570	96BP-CL	20	99BA	300
8148/RKCM	698	8210FTP	700	8889C6	570	96BP-CL/SC9	20	99SQ	23
8148/RKG	698	8216	700	8889CS	570	96BP-HO/SC9	20	99ST	24
8148/RKS	698	8216-K	700	8889I4	570	96BPINOX	293	900	86
8148/RP	698	8220	701	8889P1	569	96BPINOX/B	293	900/...	89
8148F	694	8225	701	8889P2	569	96BPINOX-AS	293	900/16	89
8149	698	8227	701	8889P3	569	96BPINOX-AS/B8	293	900/20LK	599
8149 CMC	698	8228	701	8889P4	570	96C-AS/SC9	19	900/25	89
8149CM	698	8240	701	8889PS	570	96L	20	900/25K	599
8149CM/RA	698	8240F	701	<b>9</b>		96L/SC12	20	900/32	89
8150	706	8242	702			96L/SP8	20	900/35A	89
8153	706	8242F	702	90	16	96LBP	20	900/40	90
8156	706	8248	700	90/B8N	16	96LBP/SC9	20	900/42	90
8157	706	8249	700	90/S	16	96LC	19	900/55	90
8158	707	8249G	700	90/SP	16	96LC/SC12	19	900/55Z	90
8159	707	8250	703	90AS	16	96LC/SC8	19	900/55ZK	599
8160	707	8264	703	90AS/S	16	96N	18	900/58	90
8161	707	8267	703	90BA	299	96N/B	19	900/58K	599
8166	709	8272	704	90K	596	96N/G	19	900/C11	91
8170	707	8273	704	91	17	96N/SC12	19	900/C11HR	93
8173	707	8274	702	91BA	299	96N/SC9	19	900/C11Z	91
8176	708	8274A	702	91HS	286	96N/ST	19	900/C12MR	91
8177	708	8274G	702	91HS-C	286	96N/ST6K	596	900/C12MZ	91
8178	708	8276	702	92	17	96T	21	900/C13-5	91
8179A	709	8276G	703	92BA	299	96T/AS	21	900/C13-8	91
8179B	708	8278	703	92HS	286	96T/S	21	900/C24	92
8179M	708	8279	705	93	17	96T/SP	21	900/C39N	90
8180	710	8280	703	93BA	299	96T/SPV	21	900/C39U	90
8181	710	8282S	704	93C	17	96TAS/S	21	900/R55	111
8181 6/B4	710	8284	704	93HS	286	96TBP	22	900/R55-Z	111



# ÍNDICE ALFANUMÉRICO

900/RN55	111	910/R55	111	910XZN	96	920AS/MBM-C21	108	921BA/21 - 921BA/22	301
900/SB	86	910/R55X	111	911BA	300	920AS/SB11	100	921BA/25	301
900AN	89	910/RN55	111	911BA/16	300	920ASL/SB11	100	921BA/42	301
900AS	87	910A	93	911BA/20	300	920B	99	921BA/50	301
900AS/C10 - /MB-C17	93	910A/AS	94	911BA/55	300	920B/C30Q	106	921BA/R50	301
900AS/C17-MBM	93	910A/C16...	98	914MQ/A	281	920B/SB13	99	921BA-AS	301
900AS/L	87	910A/C16HR	99	914MQ-A/S4	281	920B/SB8	100	926BA	301
900AS/MB	87	910A/C17	98	920.../C11	105	920BL	100	926BA/15	301
900AS/MBL	87	910A/SB	93	920.../C12...	105	920BL/SB11	100	926BA/22	301
900AS/SB11	87	910A-AS/SB13	94	920.../C20...	106	920BP	102	926BA/42	301
900BG/30	89	910AK	599	920.../C21...	106	920BP/SB	102	926BA/50	302
900BG/30C	89	910AL	94	920.../C33	107	920ES	103	926BA/R50	302
900BG/30K	599	910AL/SB14	94	920/15	103	920ES/SB	103	928.../C12	110
900FL	89	910AN	97	920/16	103	920ES/XL-SB	103	928/15	109
900FTX	88	910AS	94	920/20=920/23	103	920FTX	101	928/16	109
900FTX/SB9	88	910AS/C13...	99	920/21K	599	920FTX/C	101	928/20 - 928/21 - 928/22	109
900HS/55	287	910AS/L	95	920/25	103	920FTX/L	101	928/25	109
900K	599	910AS/MBM-C18	99	920/25K	600	920FTX/LSB	101	928/36A	109
900L	87	910AS/SB13	94	920/35A	103	920FTX/SB	101	928/42	109
900L/SB	87	910AS/SN	95	920/36A	104	920HS/55LC	287	928/55	109
900LP	88	910ASL/SB12	95	920/38	104	920INOX-A	294	928/R55X	112
900M/35	89	910B	94	920/40	104	920LH/SB7	101	928/RN55	112
900M/55	90	910B/C16...	98	920/42	104	920LP	101	928A	108
900M/R55	111	910B/SB	94	920/44	104	920M/35	104	928AS	109
900MB	86	910B/SN	94	920/46	104	920M/35L	104	928AS/C12	110
900MB/C19	92	910BL	94	920/50	104	920M/55	105	928B	108
900MB/C28	92	910BL/SB	94	920/50F	104	920M/56	105	928B/C12	110
900MB/L	87	910BP	96	920/55	104	920M/R55	112	928ME	109
900MB/SB	86	910BP/SB6L	96	920/55INOX	294	920MC	99	929	110
900MC/C24	92	910CF	96	920/55LC	105	920MC/C14	106	929/15	110
900MC/C32	92	910CF/SB	96	920/55Q	104	920ME	102	929/21 - 929/22	110
900MC/LP	88	910FTX	95	920/55X	104	920ME/C7	102	929/42	110
900MC/PH	88	910FTX/L	95	920/56A	105	920ME/SB	102	929/55	110
900MC/TX	89	910FTX/LSB	95	920/58	105	920MQ/21	281	929/55PR	110
900ME	88	910FTX/SB	95	920/58K	600	920MQ/22	281	929/C8	110
900ME/SB8	88	910FTX/XL	95	920/C37	107	920MQ/55A	281	929/R55	112
900PE/AS	88	910FTX-XL/C10	95	920/R50	111	920MQ/A	281	930	112
900PH	88	910HS/55	287	920/R55	111	920MQ/C16	281	930/C	112
900PH/SB4	88	910LP	95	920/R55INOX	294	920MQ/PE	281	930/S	112
900PT	88	910M/35	97	920/R55LC	112	920MQ/T	281	932	112
900PZ	88	910M/55	97	920/R55X	112	920PE	101	932/S	113
900T/44	90	910M/56	97	920/RN50	111	920PE/AS	102	932HS	287
900TX	89	910M/R55	111	920/RN50F	111	920PE/C	101	933	113
900TX/SB	89	910ME	96	920/RN55	112	920PE/SB	101	933/S	113
900U	87	910ME/SB	96	920/RN55LC	112	920PE-AS/SB6	102	935	113
900U/C12M	92	910MQ/21	280	920/RN55Q	112	920PH	101	935/S	113
900U/SB	87	910MQ/22	280	920/RN55X	112	920PH/SB4	101	935K	600
902A/C22	93	910MQ/55	280	920A	99	920RTX	102	937	113
902R/C6	93	910MQ/B	280	920A/AS	100	920RTX/SB	102	937/S	113
910.../C10	98	910MQ/C16	280	920A/C17HR	108	920TX	102	937BA	302
910.../C29	98	910MQ/PE	280	920A/C17M	107	920TX/C	102	937K	600
910/15	96	910MQ/PT	280	920A/C17MR	107	920TX/C17	108	940	113
910/16	97	910MQ/T	280	920A/SB13	99	920TX/L-SB10	102	941	113
910/20 - 910/21 - 910/22	97	910MQ/TX	280	920A/SB8	99	920TX/SB	102	941/S	113
910/21K	599	910MQ/XZN	280	920A-AS/SB11	100	920U	100	942BX	114
910/25	97	910PE	96	920AK	599	920U/SB13	100	942BX/DG	611
910/25K	599	910PE/AS	96	920AL	100	920U/SB4	101	942BX/S	114
910/36A	97	910PE/SB	96	920AL/SB11	100	920XZN	103	943BX	114
910/40	97	910PH	95	920AN	103	920XZN/LS	103	943BX/D	114
910/42	97	910PH/SB4	95	920AS	100	920XZN/SB12	103	943BX/DG	611
910/46	97	910PT	96	920AS/C10	107	920XZN/SB7	103	943BX/S	114
910/55	97	910PT/SB	96	920AS/C15	107	921BA	301	943BXK	600
910/58	98	910TX	96	920AS/C17X	108	921BA/15	301	943FL	114
910/58K	599	910TX/SB	96	920AS/L	100	921BA/16	301	943FL/S	114





# ÍNDICE ALFANUMÉRICO

943MQ	281	961P6/S	121	9503TL	715	9565K	725	9812M	573
943MQ/BG	611	962	121	9504TL	715	9565S	669	9813H	573
943MQ/S	281	962C	270	9510W	716	9565T	725	9821L	574
944BX	114	962M	121	9520P	721	9566K	725	9822M	574
944BX/D	114	962P	121	9521	721	9566S/3	725	9823H	574
944BX/DG	611	963	121	9521OB	721	9569MS	724	9831L	574
944BX/S	114	963BA	302	9522A	721	9569MS-2	724	9832M	574
949	114	964	121	9523A	722	9569P	724	9833H	574
949/S6	115	964BA	302	9523T	722	9569S	724	9840BF - Beta Fix	575
950	115	964BA/L	302	9524SC	721	9572LB	716	9841N	575
950/S	115	965	121	9525CM	716	9574B	717	9841R	576
951	115	965/S	122	9525TR	716	9574O	717	9842W - Acryl Seal	575
951/S	115	965BA	302	9525WB	716	9577R	716	9843T - Multi Sil	575
951/SP	115	966/C3	122	9526F	722	9579C	716	9844T - Neutral Sil	575
951AS	116	966BA	302	9526MC	722	9580S	717	9851	576
951AS/S	116	966BA/V	302	9526RMN	721	9586K	722	9860 - Multi Foam	575
951BA	302	969/C5	122	9527 6T	722	9587 13x21	723	9881U	578
951GP	116	969B	122	9527T	722	9587 9x14	723	9882R	578
951GP/S6	116	970B	122	9528B	722	9588/10PI	723	9899 CV/A	111
951K	600	970IVECO	122	9528C	721	9588M	723	9899 CV/B	111
951MQ	281	971/C8	122	9534BO	716	9588S/10...	724	9899 CV/C	111
951TX	116	972/C10	122	9534WO	716	9589A/36	724	<b>C</b>	
951TX/S	116	972/C4BMW	122	9539CB	718	9589B/36	724		
952	117	973	123	9541BIKE	717	9592AC	723	C3	350
952/D7	117	978 - 979	123	9541F	717	9592B/C50	723	C5 - 2105	350
952/S	117	982	123	9541PC	718	9592B/P	723	C5S	350
952AS	117	983 PM/R-DA	123	9541S	718	9592MG/3	723	C6T - 2106	351
952FTX	117	983PM	123	9542AL	718	9593A	717	C7 - 2107	351
952FTX/S	117	984	123	9542C	718	9593M	717	C7AT	351
952L	117	985/B7	123	9542G	718	9593SB	717	C8 - 2108	351
953	117	985F	123	9542GW	719	9593W	717	C8B	351
953/S	117	985M	123	9542M	719	9594	724	C9 - 2109	351
953TX	117	986 48	123	9542S	719	9595C	724	C9/RT	352
953TX/S	117	986 78	123	9543C	717	9595T	724	C9DA	352
955	118	986PT	124	9544C	718	9596	724	C9MT	352
956C	118	987	124	9547	723	9597P	720	C9PT	314
956E	118	987AR	124	9547T	721	9597TRIOWAY	719	C04TSS-7	296
956F	118	987P	124	9547WSK	721	9598WHP-N	720	C10 - 2110	352
956L	118	988/K4	124	9548G	721	9598W-N	719	C10S - 2110S	353
957	118	989	124	9548KB	720	9599CB-N2	720	C11 - 2111	353
959	119	989A	124	9548KB 20	720	9599CB-WN	720	C12 - 2112	353
959R	119	989B	124	9548KB 24	720	9710 - LUBRIBETA universal	576	C13	353
960/C6	119	990	124	9549ABW	722	9712 - Ultra Sblock	576	C14	353
960A	119	991	124	9549BP	722	9720 - Multi Grease	576	C16 - 2116	354
960AVE	119	992	124	9549BRW	722	9722 - Lithium Grease	576	C18 - 2118	354
960EPC/L	119	993	124	9549C	722	9724 - PTFE Grease	576	C19 - 2119 - C19L - 2119L	355
960E-PI/P	120	993G	125	9549CR	723	9726 - Copper Grease	577	C20 - C20L - 2120	355
960ER	119	993MQ	282	9549MPC	723	9729 - Silic Spray	577	C20TSS	295
960KC-M8/M9/M10	120	993PL	124	9549SBW	723	9738 - Cutting Oil	577	C22B	355
960KPC	120	994	125	9557J 2.0	718	9740 - Brake Cleaner	577	C22P	355
960P	120	994MQ	282	9559	726	9741 - Multi Cleaner	577	C22W	355
960PI	120	994PL	125	9559/S	726	9742 - Contact Cleaner	577	C25	372
960PI/C19	120	994TF	125	9561V	726	9745 - Carb Cleaner	577	C27S	373
960PI/K36	120	996	125	9561VV	726	9746 - Clima Cleaner	577	C30M	375
960PI/S	120	998	125	9561VV 2,5	726	9749 - Air Spray	578	C35/6GM	376
960PMC	121	999	125	9562	726	9752 - Zinc 98%	578	C35/7GM	377
960RPI	121	999/B6N	125	9562P12	725	9755 - Welding Spray	578	C35/8GM	377
960SL	119	999A	125	9562P2	725	9765 - Deicer Spray	578	C35/9GM	377
960SN	119	999B	125	9562T1	269	9775 - Water Stop	578	C37/6	379
960T/C11	119	999C	125	9562T2	726	9801L	573	C37/7	378
960UC	120	999D	125	9562T3	269	9802M	573	C37/8	379
960VTC	121	999E	125	9562TB	669	9803H	573		
961BA	302	999G	125	9563G	725	9811L	573		
961N	121	9501TLD	715	9563U	725				



# ÍNDICE ALFANUMÉRICO

C37A/7	379	C45PRO 2.0 MWS/W	473	C55M4	429	C58CSH 5C	408
C39/6	382	C45PRO 2.0 MWS/X	473	C55M7	429	C58CSH 6C	408
C39/7	381	C45PRO 2.0 PAS	482	C55M8	430	C58GF	405
C39/8	382	C45PRO 2.0 PF	482	C55MA	431	C58GRF	405
C39MD	384	C45PRO 2.0 PFE	482	C55MDO	431	C58GRGM	405
C39SM	384	C45PRO 2.0 PM	484	C55MP	437	C58GT	405
C39T	382	C45PRO 2.0 PML	485	C55MS	432	C58K/2PF-1,6M	408
C41H	385	C45PRO 2.0 PWE/1-0,7MT	474	C55P/2MDX-SX	433	C58K/2PF-2,1M	409
C41H/CE	385	C45PRO 2.0 PWE/2-1,3MT	474	C55P/MCD	433	C58K/4PF-1,6M	409
C41S	385	C45PRO 2.0 PWE/3-2,0MT	475	C55PB/3	419	C58K/4PF-2,1M	409
C42H	386	C45PRO 2.0 PXE/1-0,7MT	474	C55PB-PRO/7	420	C58MA	407
C45PRO 2.0 A1/R600	485	C45PRO 2.0 PXE/2-1,3MT	474	C55PB-PRO/8	420	C58MP-0,8M	411
C45PRO 2.0 A1/RB600	485	C45PRO 2.0 PXE/3-2,0MT	475	C55PFA-0,8	435	C58MP-1M	411
C45PRO 2.0 ACT	480	C45PRO 2.0 RD/W	478	C55PFA-1,0	433	C58P	396
C45PRO 2.0 AS1	485	C45PRO 2.0 RD/X	478	C55PM	433	C58PFL	410
C45PRO 2.0 AS2	486	C45PRO 2.0 SL	481	C55PM/M0,8	435	C58PLED-150	411
C45PRO 2.0 AS2/3C	486	C45PRO 2.0 SS	481	C55PRO B/2	421	C58PLED-90	412
C45PRO 2.0 AW	468	C45PRO 2.0 T3	481	C55PRO B/2,8	422	C58PLT-W 1,6	404
C45PRO 2.0 AX	468	C45PRO 2.0 TC	481	C55PRO B-D4	423	C58PLT-W 2,1	404
C45PRO 2.0 BLW	472	C45PRO 2.0 W	467	C55PS	436	C58PLT-X 1,6	404
C45PRO 2.0 BLX	472	C45PRO 2.0 X	466	C55PSE	436	C58PLT-X 2,1	405
C45PRO 2.0 BPW-1,3	471	C45PRO A2/R915	486	C55PT0,8X0,6	435	C58SP 1,6	410
C45PRO 2.0 BPW-2,0	471	C45STR	487	C55PT1,0X0,6	434	C58SP 2,1	410
C45PRO 2.0 BPX-1,3	471	C48M	388	C55PTE-0,8	435	C59A	413
C45PRO 2.0 BPX-2,0	470	C48P	389	C55PTE-1,0	434	C59B	413
C45PRO 2.0 BW	469	C51	389	C55RB	426	C59C	414
C45PRO 2.0 BX	468	C54S	393	C55STR	440	C62M/WW	668
C45PRO 2.0 C5	475	C55	418	C55T3	432	C64	668
C45PRO 2.0 C7	476	C55 A1/RB42	438	C56	412	C64CW	669
C45PRO 2.0 CAI/W	484	C55/1PF	435	C56P O	392	C64G	669
C45PRO 2.0 CAI/X	484	C55/2PM	434	C56PL O	392	C68	615
C45PRO 2.0 CORNER/W	483	C55/PF	433	C56W	412	C68 G	615
C45PRO 2.0 CORNER/X	483	C55/PL-1,024	426	C57SA	394	C68N	615
C45PRO 2.0 CPF	474	C55A1	438	C57SB	395	C88 R/1	615
C45PRO 2.0 CW	470	C55A1/R42	438	C57SC	395	C88/R601	623
C45PRO 2.0 CX	470	C55A2	439	C57SD	394	C88/R611	623
C45PRO 2.0 DW	465	C55A2/R70	439	C57SP	396	C88SE	615
C45PRO 2.0 DX	464	C55AB	419	C58BAC 1,6	410	C88VE	615
C45PRO 2.0 EW	469	C55AC	437	C58BAC 2,1	410	C99	356
C45PRO 2.0 EX	469	C55AE	436	C58BC-W1,6	397	C99P	358
C45PRO 2.0 FW	465	C55AT1	440	C58BC-W1,6 2C	398	C99PP	358
C45PRO 2.0 FX	465	C55AT2	440	C58BC-W1,6 4C	399	C99V0	356
C45PRO 2.0 GW	466	C55B PT/2	426	C58BC-W2,1	399	C99V0-P12	357
C45PRO 2.0 GX	466	C55B PT/2,8	426	C58BC-W2,1 2C	400	C99V2	357
C45PRO 2.0 HW	467	C55B/2	421	C58BC-W2,1 4C	401	C99V3/2C	358
C45PRO 2.0 HX	467	C55B/2,8	422	C58BC-W2,1 4CA	401	CA49-G	387
C45PRO 2.0 M3A	479	C55B/G	424	C58BC-W2,1 6CA	402	CB52	391
C45PRO 2.0 M4	476	C55B/GAA	424	C58BC-W2,1 8CA	402	CB/2	571
C45PRO 2.0 M5	476	C55B/GAE	425	C58BC-X1,6	398	CD23S	360
C45PRO 2.0 M7	477	C55B/GDP	424	C58BC-X2,1	400	CP15 - 2115	353
C45PRO 2.0 M7A/W	473	C55B/GDS	424	C58BC-X2,1 4C	403	CP15L - 2115	354
C45PRO 2.0 M7A/X	472	C55B/GE	425	C58BC-X2,1 4CA	403	CP17 - CP17L - 2117	354
C45PRO 2.0 M8	477	C55B/VS	426	C58BC-X2,1 8CA	404	CP51	391
C45PRO 2.0 MA	478	C55B-D4	423	C58BLP-1,6M	411	CPMB/3C	489
C45PRO 2.0 MAL	479	C55C7	427	C58BLP-1M	411	CPMB/5C	490
C45PRO 2.0 MAT	479	C55C8	428	C58CS 1C	406	CP	490
C45PRO 2.0 ML	480	C55CS	430	C58CS 2C	406	CX49-G	387
C45PRO 2.0 MP	482	C55KAI	437	C58CS 3C	406		
C45PRO 2.0 MRE	480	C55M2	428	C58CSH 3C	407		
C45PRO 2.0 MS	477			C58CSH 4C	407		

<b>G,K</b>	
GM	570
KIT 10VC/5C	490
KIT 6VC/3C	489
KIT/GPS	570
<b>M</b>	
M3CA	491
M01	544
M01K	609
M02	544
M05	544
M06	544
M13	544
M25	544
M30	544
M31	545
M32	545
M33	545
M38	545
M40	545
M44	545
M45	545
M46	545
M49	545
M50	545
M52	546
M53	546
M55	546
M60	546
M62	546
M63	546
M63K	609
M65	546
M67	546
M69	546
M75	547
M78	547
M82	547
M83	547
M85	547
M86	547
M91	547
M92	547
M94	547
M96	547
M100	548
M105	548
M108	548
M110	548
M112	548
M115	548
M118	549
M120	549
M121	549
M125	549
M126	549
M127	549
M128	549
M129	549
M129K	609
M133	549



# ÍNDICE ALFANUMÉRICO

M134	550	MM105	558	RSC50 2.0 M10	454	T34	560	T183	566
M135	550	MM129	558	RSC50 2.0 M4	452	T40	560	T198	566
M136	550	MM210	558	RSC50 2.0 M5	452	T41	560	T199	566
M137	550	MM230	558	RSC50 2.0 M6	453	T45	561	T201	566
M145	550	MM400	558	RSC50 2.0 M7	453	T46	561	T202	566
M153	550	MM401	559	RSC50 2.0 M8	453	T48	561	T204	566
M161	550	<b>P</b>		RSC50 2.0 MA	455	T50	561	T205	566
M162	550		RSC50 2.0 MDO	456	T52	561	T206	566	
M166	550	PM 1/2-Q5	72	RSC50 2.0 ML	456	T55	561	T207	566
M170	550	PM/5C	490	RSC50 2.0 MS-2AVV	455	T59	561	T208	566
M172	551	PM/6C	490	RSC50 2.0 MS-2C	454	T63	561	T209	567
M174	551	PV	396	RSC50 2.0 MS-AVV	454	T64	561	T211	567
M180	551	<b>R</b>		RSC50 2.0 MTP	458	T65	561	T213	567
M195	551		RSC50 2.0 NAC	459	T68	561	T216	567	
M201	551	RSC22	359	RSC50 2.0 NAC-W	460	T73	561	T221	567
M204	551	RSC23	360	RSC50 2.0 NAC-X	460	T75	562	T226	567
M208	551	RSC23C	360	RSC50 2.0 NP/1-0,7MT	448	T76	562	T227	567
M209	551	RSC23T	361	RSC50 2.0 NP/2-1,5MT	448	T77	562	T228	567
M213	551	RSC24/5	363	RSC50 2.0 NP/3-2,2MT	449	T80	562	T231	567
M213K	609	RSC24/6	363	RSC50 2.0 P/2MDX-SX	458	T81	562	T233	567
M214	552	RSC24/7	362	RSC50 2.0 PFI	457	T82	562	T234	567
M216	552	RSC24/8	363	RSC50 2.0 PFS	457	T83	562	T236	567
M217	552	RSC24A/6	364	RSC50 2.0 PM	458	T85	562	T239	568
M218	552	RSC24A/7	364	RSC50 2.0 PS	459	T91	562	T241	568
M222	552	RSC24A/8	364	RSC50 2.0 PW/1-0,7MT	449	T92	562	T259	568
M223	552	RSC24AXL/7	365	RSC50 2.0 PW/2-1,5MT	449	T99	563	T264	568
M226	552	RSC24AXL/8	366	RSC50 2.0 PW/3-2,2MT	450	T100	563	T270	568
M227	552	RSC24AXL/9	366	RSC50 2.0 PX/1-0,7MT	449	T101	563	T271	568
M230	552	RSC24AXLP/7	367	RSC50 2.0 PX/2-1,5MT	449	T102	563	T273	568
M231	552	RSC24AXXL	368	RSC50 2.0 PX/3-2,2MT	450	T103	563	T279	568
M234	553	RSC24L/7	371	RSC50 2.0 RB	450	T105	563	T284	568
M236	553	RSC24L-CAB	371	RSC50 2.0 T3	456	T106	563	T285	568
M237	553	RSC28	374	RSC51	390	T111	563	T291	568
M240	553	RSC50 2.0	444	<b>S</b>		T112	563	T294	569
M264	553	RSC50 2.0 A	448		T113	563	T297	569	
M284	553	RSC50 2.0 A1	461	S4CA	487	T122	563	TSPP	571
M292	553	RSC50 2.0 A1/R59	461	S4CB	487	T123	563	<b>V</b>	
M294	553	RSC50 2.0 A1/RB59	462	S42/17	571	T124	564		
M295	553	RSC50 2.0 A2	462	S55/12	570	T135	563	VE1	570
M400	554	RSC50 2.0 A2/3C	462	S55/8	570	T136	564	VP1 - VP2	569
M401	554	RSC50 2.0 A2/R91	462	S96T/8	571	T137	564	VP3 - VP4	569
MB12	555	RSC50 2.0 B	447	S951/6	571	T138	564	VP5	569
MB37	555	RSC50 2.0 C	447	S952/10	571	T140	564	VP6	569
MB39	555	RSC50 2.0 C5	450	S1719BM	571	T144	564	VP7-C	569
MB44	555	RSC50 2.0 C6	451	SB	570	T145	564	VP-3SC	569
MB46	555	RSC50 2.0 C7	451	SCG	415	T146	564	VP-LS	569
MB47	555	RSC50 2.0 C8	452	SGN	571	T151	564	VPM0	559
MB58	556	RSC50 2.0 CS	455	SP5S	491	T153	564	VPM3	559
MB59	556	RSC50 2.0 D	446	SPC	491	T156	564	VPM7	559
MB63	556	RSC50 2.0 DW	447	SPG11 - S1203/8	571	T157	565	VPM7-C	559
MB64	556	RSC50 2.0 DX	446	SSPE	484	T160	565	VPM8	559
MB65	556	RSC50 2.0 E	446	ST2P	570	T161	565	VPM9	559
MB	570	RSC50 2.0 F	445	<b>T</b>		T164	565		
MC10	554	RSC50 2.0 FW	445		T167	565			
MC12	554	RSC50 2.0 FX	445	T01	560	T168	565		
MC20	554	RSC50 2.0 G	444	T05	560	T170	565		
MC21	554	RSC50 2.0 H	444	T06	560	T171	565		
MM11	557	RSC50 2.0 I	443	T23	560	T172	565		
MM26	557	RSC50 2.0 KNAI	460	T24	560	T173	565		
MM30	557	RSC50 2.0 KNAI-W	461	T28	560	T175	565		
MM60	557	RSC50 2.0 KNAI-X	461	T29	560	T176	565		
MM63	557	RSC50 2.0 KPF	457	T31	560	T177	566		
MM100	557	RSC50 2.0 L	443	T33	560	T180	566		





**10 unidades  
de produção  
EM ITÁLIA**



**1.000  
colaboradores**

**12 filiais  
em todo o mundo**

Atividade em mais de  
**100 países**  
com mais de  
**250 importadores**



**BETA UTENSILI S.p.A.** - 20845 Sovico (MB)  
Via A. Volta, 18 - Tel. 039.2077.1 - Fax 039.2010742  
[www.beta-tools.com](http://www.beta-tools.com)

**Robur Wire rope accessories:**  
67039 Sulmona (AQ) Zona industriale - C.da S. Nicola  
Tel. 0864.2504.1 - Fax 0864.253132  
[www.roburitaly.com](http://www.roburitaly.com) - [info@roburitaly.com](mailto:info@roburitaly.com)





# A HISTÓRIA DAS FERRAMENTAS ITALIANAS

- 1923** ● Alessandro Ciceri fundou a “**Alessandro Ciceri & Figli**”, em Erba (na província de Como), dedicada ao fabrico de peças fundidas em ferro e aço.
- 1939** ● A marca Beta foi registrada e a Empresa passou a dedicar-se sobretudo ao **fabrico de ferramentas profissionais** na fábrica de Sovico (na província de Monza e Brianza), onde ainda está sediada.
- 1960** ● A Beta Utensili contava com cerca de duzentos colaboradores, estabeleceu-se como fabricante de ferramentas manuais profissionais e exportou os seus produtos.
- 1969** ● Foi lançado o **revolucionário carro “Tank”** em chapa cor de laranja; a partir desse momento a cor laranja resultaria num estilo único para a marca Beta.
- 1971** ● A Beta Utensili entrou no **mundo do automobilismo** - primeiro na Fórmula 1 e depois nos ralis e nos desportos motorizados em geral.
- 1973** ● Foi inaugurada a **fábrica de Castiglione d’Adda** (na província de Lodi), juntando-se assim à já estabelecida fábrica em Sovico (na província de Monza e Brianza).
- 1975** ● Conquistou a sua primeira vitória na Fórmula 1, com o **March-Beta Utensili** laranja pilotado por Vittorio Brambilla, que venceu o Grande Prémio da Áustria em Zeltweg, sob chuva torrencial.
- 1984** ● A Empresa **inaugurou a sua terceira fábrica em Sulmona** (na província de L’Aquila). Começou a fabricar as icónicas chaves combinadas, item 42. A produção e os testes de acessórios de elevação tiveram início sob a marca Robur.
- 1990** ● A Beta Utensili **penetrou ainda mais nos principais mercados europeus**, estabelecendo filiais em França, Grã-Bretanha, Holanda, Espanha, Polónia e Hungria.
- 2000** ● O **novo catálogo Beta Utensili** demonstrou um **crescimento contínuo**: a gama de produtos disponíveis foi duplicada, com mais de 10.000 artigos codificados divididos em 22 famílias de produtos.
- 2002** ● A gama da Beta Utensili foi ampliada, sendo complementada com **calçado de segurança** e também com a **coleção de trabalho** e lazer “Beta Work”.
- 2009** ● A Beta começou a expandir-se, estabelecendo a **Beta China** e, três anos depois, a **Beta no Brasil**.
- 2016** ● A Beta lançou o novo **sistema modular de equipamentos de oficina, RSC55**.
- 2018** ● O Grupo Beta consolidou-se ainda mais ao adquirir a **BM S.p.A.**, fabricante líder de terminais e sistemas de ligação elétrica, a **3D Beta S.r.l.**, empresa especializada no design e produção de sistemas modulares de equipamentos de oficina personalizados, e a **VGF S.r.l.**, empresa especializada no revestimento eletrostático de mobiliário de oficina.
- 2019** ● Foram também adquiridos os principais fabricantes de abrasivos rígidos e flexíveis, **Abra Beta S.p.A.** e **Elpa Abrasivi S.r.l.**
- 2020** ● A Beta entrou no mercado norte-americano estabelecendo a filial **Beta USA**.
- 2023** ● Ao celebrar o 100º aniversário da sua fundação, o **Grupo Beta** cresceu ainda mais ao adquirir a **Helvi S.p.A.**, um importante player na indústria de soldadura. O Departamento de Investigação e Desenvolvimento lançou dois produtos de fabrico italiano: o **sistema modular de equipamento de oficina, RSC50**, e a **chave dinamométrica, 666**, com tecnologia Zero-Reset.
- 2024** ● O Grupo Beta possui mais de **1.000 colaboradores** em todo o mundo, contando com **40 famílias de produtos e mais de 30.000 artigos**, concebidos e fabricados para satisfazer as necessidades dos profissionais e garantir a qualidade e o desempenho contínuos, de acordo com o princípio **Beta Well Done**, porque na Beta apenas conseguimos fazer as coisas bem.



1923 Alessandro Ciceri & Figli



1939 Ofi cina de Forja



1955 Ofi cina de Corte

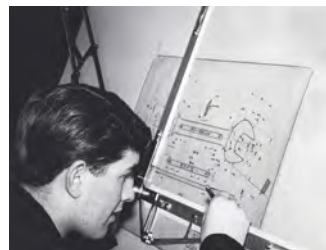

1960 Departamento de Design



1969 Tank trolley



1974 Anúncio a jogos de ferramentas



1975 Vittorio Brambilla



2002 “BetaWork”

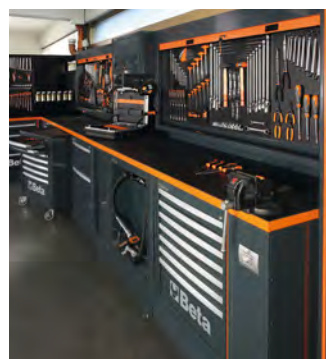

2016 Mobiliário de Oficina RSC55



2024 Fabio Quartararo, Embaixador da Beta





# QUALIDADE CERTIFICADA

Em 2018 os carros de ferramentas Beta receberam a prestigiada certificação TÜV, após passarem por rigorosos testes de acordo com o protocolo EK5/TA5.

O protocolo EK5/TA5 verifica 31 características de construção bem definidas, exigentes testes estáticos e de comportamento dinâmico. Outros testes determinam a resistência a altas e baixas temperaturas, a vida útil das marcações e a resistência à corrosão.

O mérito por essa conquista deve-se ao design especializado, ao fabrico preciso e aos testes rigorosos aos quais a Beta submete os seus carros de ferramentas, o que permitiu que a sua qualidade fosse reconhecida pelos utilizadores.

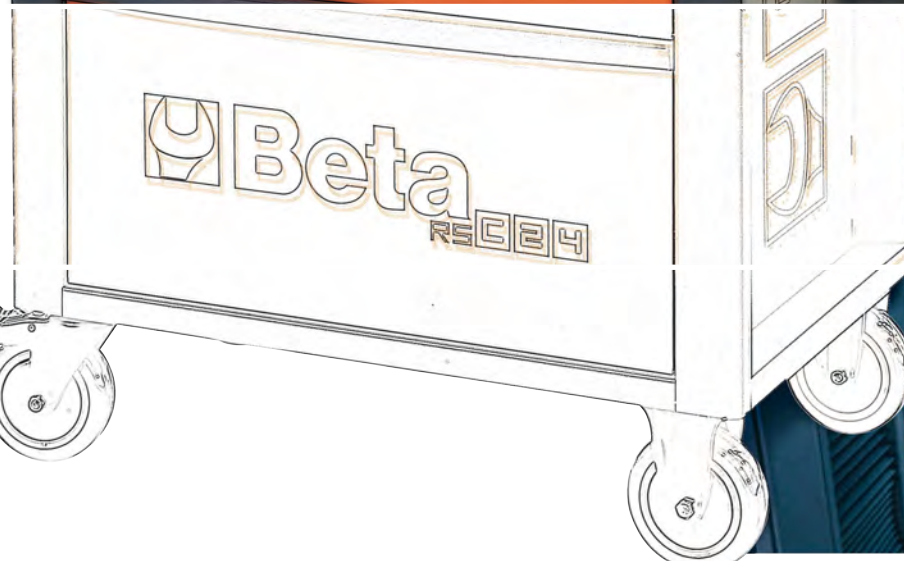





# CONTROLO E QUALIDADE

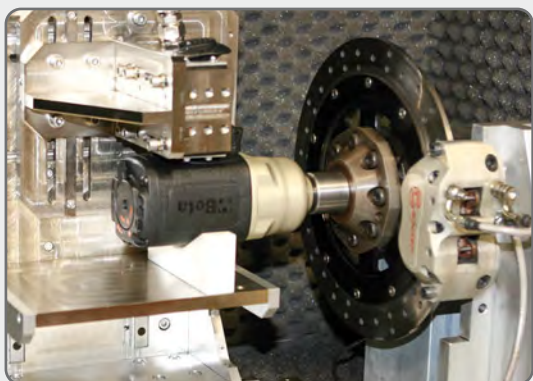
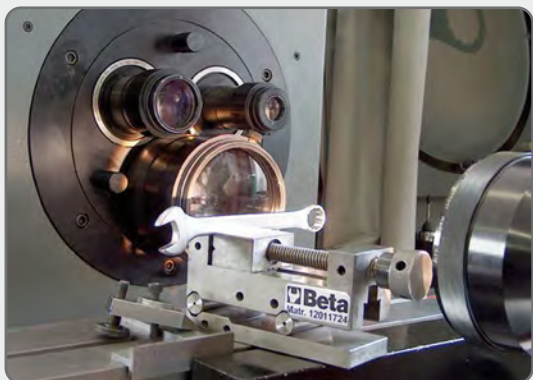

Na Beta, a qualidade tem um significado simples e concreto: “aquilo que satisfaz plenamente as necessidades e expectativas dos utilizadores profissionais que dependem dos nossos produtos como um instrumento de trabalho insubstituível”. As ferramentas não são apenas concebidas e fabricadas para satisfazer apenas uma necessidade, mas para garantir performances consistentes ao longo do tempo. Na Beta, a qualidade significa mais do que uma mera política de fabrico e vendas atenta, englobando todos os departamentos da empresa no sentido de atingir metas cada vez mais ambiciosas em termos de satisfação do cliente. A Beta tem construído a sua história com base neste mesmo conceito.

**Qualidade Beta,**  
A nossa prova  
mais concreta

A qualidade das ferramentas  
Beta é uma sinergia  
entre técnicas  
tradicionais e novas  
tecnologias.



**Desde 1995 os nossos processos  
de produção têm respeitado os padrões  
do Sistema de Qualidade  
ISO 9001**







**32.000 m<sup>2</sup>**  
de superfície

**45.000**  
referências  
e mais de **35.000**  
unidades de carga

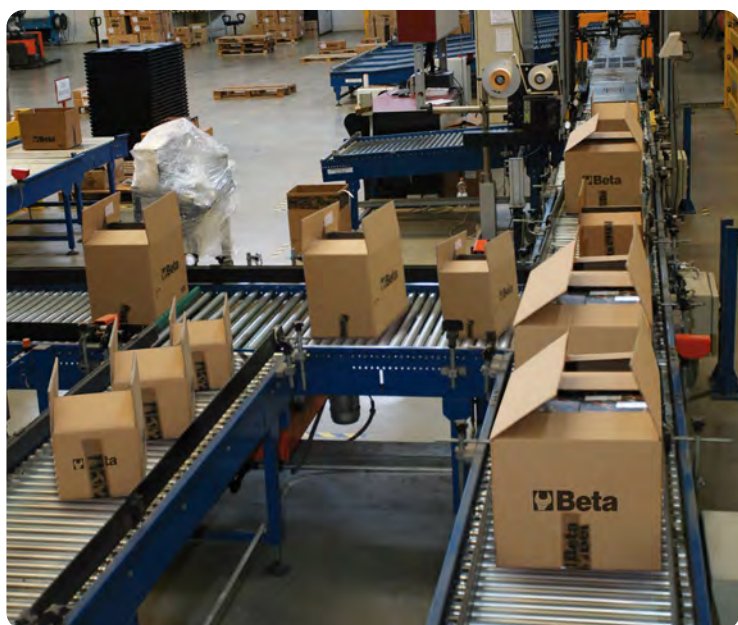

**Entregas rápidas,  
precisas e completas**







# ORGANIZAÇÃO DO TRABALHO

consiste num método de organização do espaço de trabalho de origem japonesa. O nome deriva da transcrição ocidental de 5 palavras japonesas: seiri, seiton, seiso, seiketsu and shitsuke.

Ao seguir os 5 passos anteriormente identifi cados, é possível implementar um método sistemático e consistente, com planos de trabalho otimizados e funcionais.



## SEIRI ORGANIZAÇÃO

Retire todos os itens/produtos desnecessários do espaço de trabalho; Mantenha apenas o necessário.



## SEITON

### ORDEM

Coloque tudo no seu devido lugar: um lugar para tudo e tudo no seu lugar.



## SEISO

### LIMPEZA

Mantenha o espaço de trabalho limpo e arrumado.



## SEIKETSU

### PADRONIZAÇÃO

Estabeleça práticas de trabalho consistentes para racionalizar os recursos e espaços, defini dos com a implementação de um padrão.



## SHITSUKE

### SUSTENTABILIDADE

Apoie e divulgue este método de organização.



## BENEFITS



Economia de tempo, relação custo/efi ciência melhorada



Melhor qualidade e produtividade



Acidentes de trabalho reduzidos



Maior eficiência

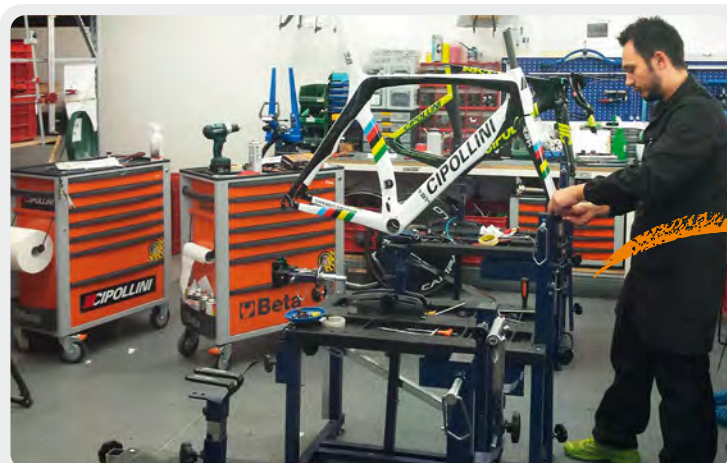

ANTES

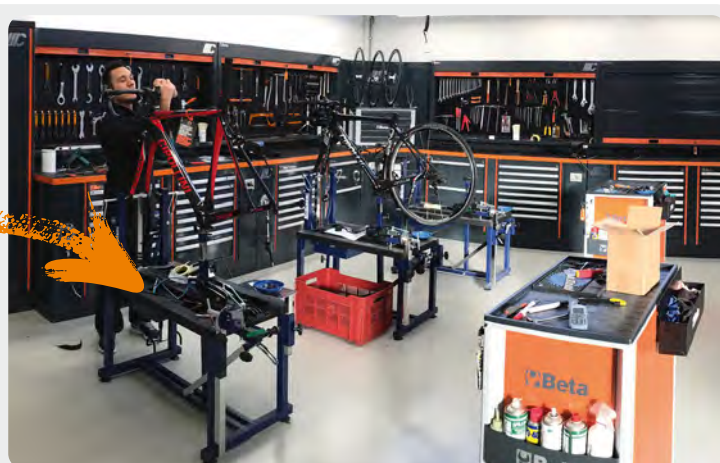

DEPOIS





# PRESENÇA E EXPERIÊNCIA TÉCNICA NA ÁREA



Os consultores de vendas da Beta trabalham em sinergia com a ampla rede de revendedores e distribuidores, para disponibilizar os seus conhecimentos e competências. Por sua vez, os nossos **Demonstradores** utilizam as Carrinhas de Demonstração da Beta, equipadas com a mais moderna tecnologia, para testar os produtos e equipamentos e avaliar as suas características, qualidade e funcionalidade.

Novidade para 2024, o **Equipamento de Oficina Beta** inclui duas combinações de equipamentos de oficina das gamas, **C45PRO 2.0** e **RSC50 2.0**, e permite-lhe personalizar a sua garagem através de um **computador de parede**.





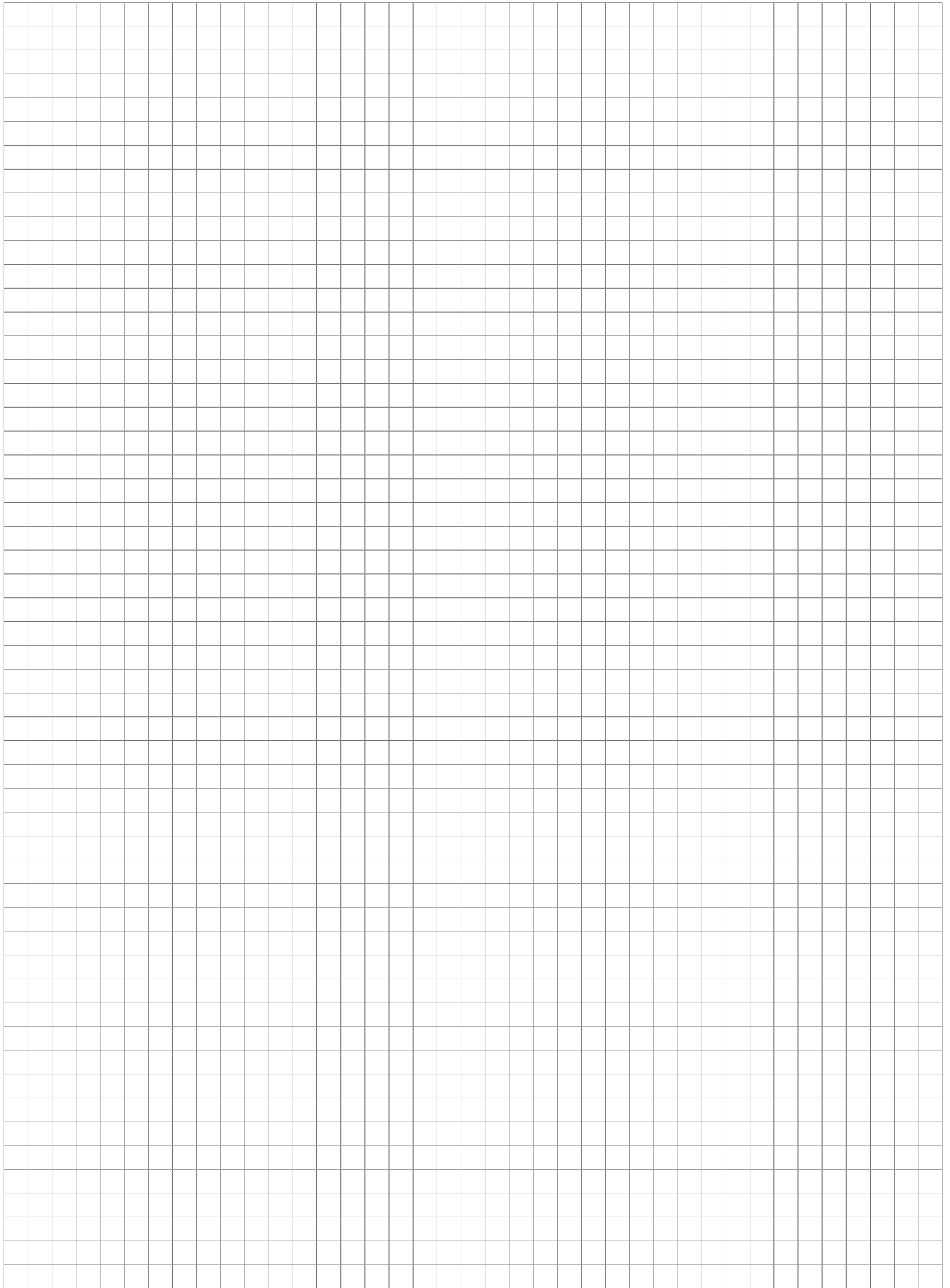





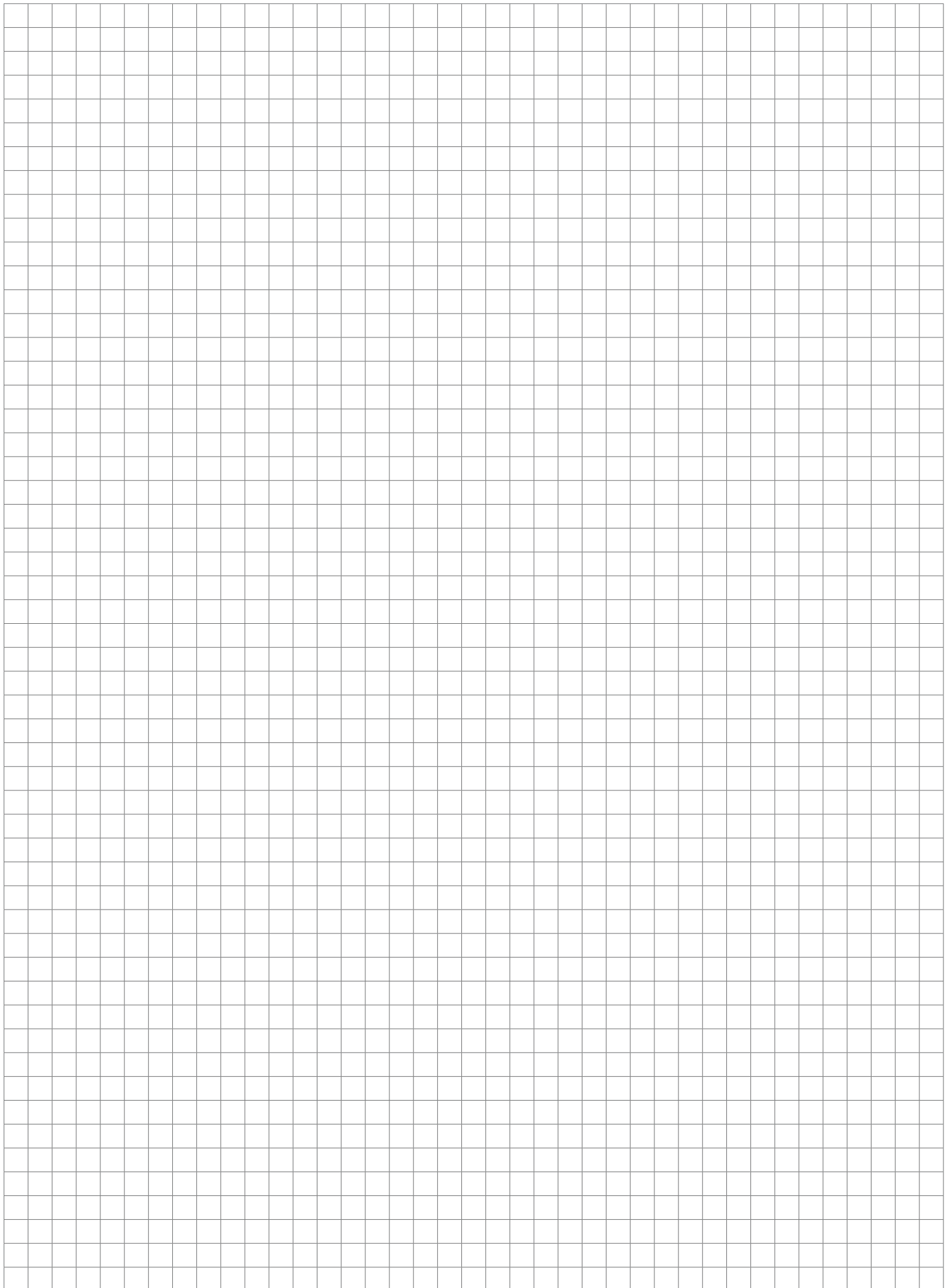





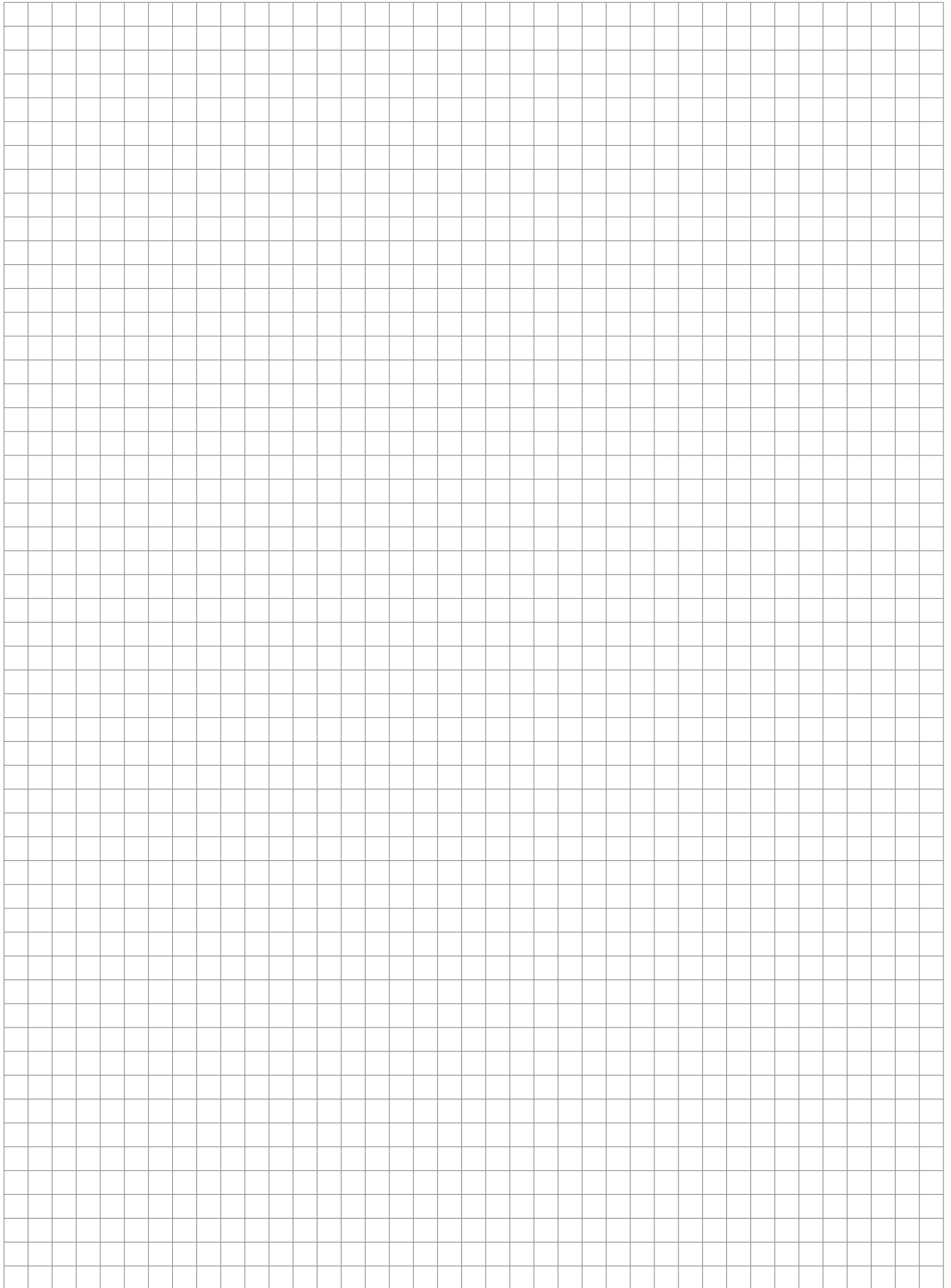



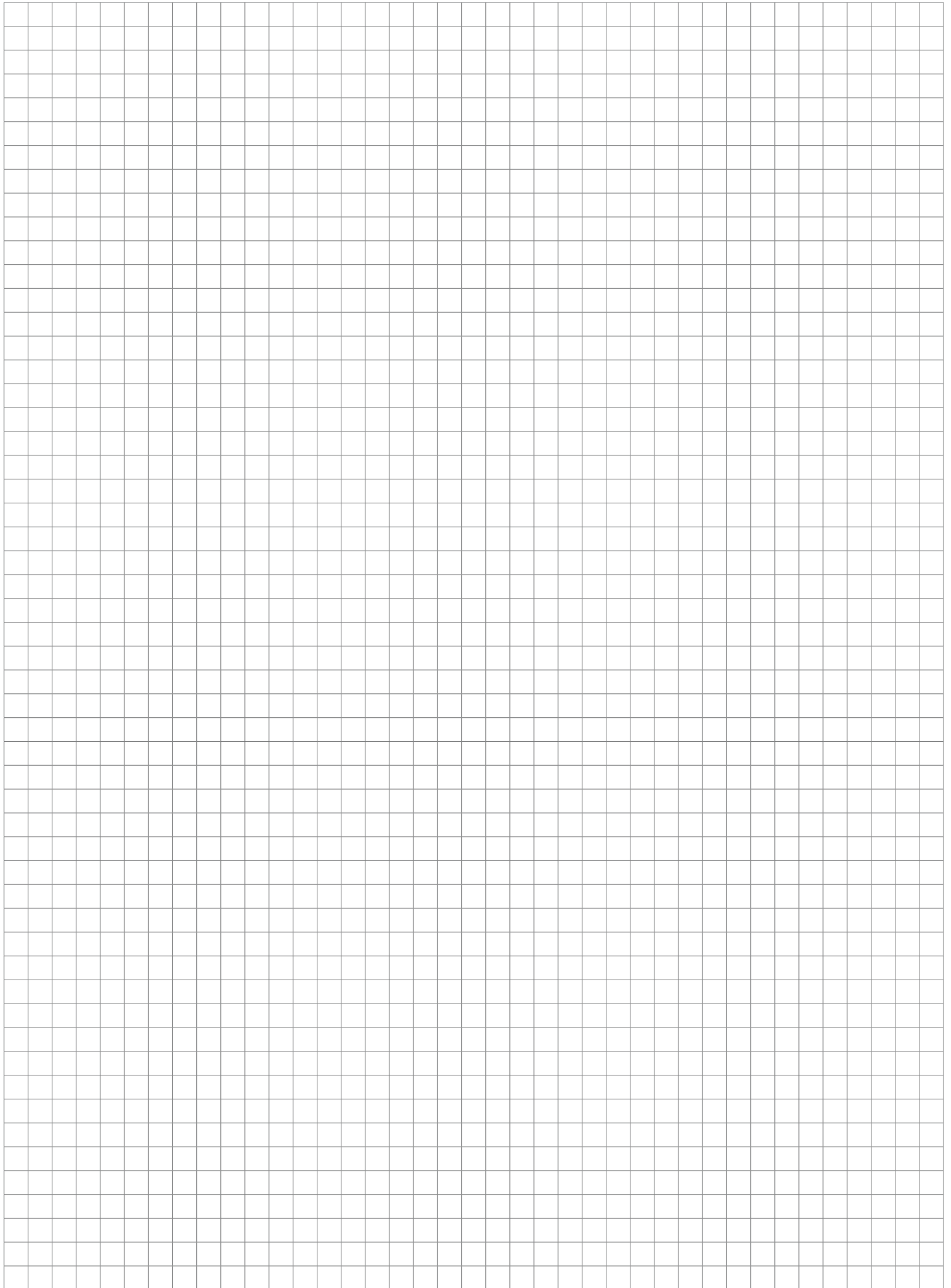





# 2024 MotoGP World Championship



**OFFICIAL SPONSOR**  
MotoGP Team 2024

Fabio  
Quartararo

 **Beta**

50 Years in Motorsports



PARTNERSHIP

20  
24

ALONSO LÓPEZ

FERMÍN ALDEGUER



2024 MOTO2  
WORLD CHAMPIONSHIP



Technical Partner



Official partner of  
aprilia RACING



LEOPARD RACING



Ecosantagata Althea  
Racing Team

